



ASR 5500 System Administration Guide, StarOS Release 21.17

First Published: 2019-12-19

Americas Headquarters

Cisco Systems, Inc.
170 West Tasman Drive
San Jose, CA 95134-1706
USA
<http://www.cisco.com>
Tel: 408 526-4000
800 553-NETS (6387)
Fax: 408 527-0883

THE SPECIFICATIONS AND INFORMATION REGARDING THE PRODUCTS IN THIS MANUAL ARE SUBJECT TO CHANGE WITHOUT NOTICE. ALL STATEMENTS, INFORMATION, AND RECOMMENDATIONS IN THIS MANUAL ARE BELIEVED TO BE ACCURATE BUT ARE PRESENTED WITHOUT WARRANTY OF ANY KIND, EXPRESS OR IMPLIED. USERS MUST TAKE FULL RESPONSIBILITY FOR THEIR APPLICATION OF ANY PRODUCTS.

THE SOFTWARE LICENSE AND LIMITED WARRANTY FOR THE ACCOMPANYING PRODUCT ARE SET FORTH IN THE INFORMATION PACKET THAT SHIPPED WITH THE PRODUCT AND ARE INCORPORATED HEREIN BY THIS REFERENCE. IF YOU ARE UNABLE TO LOCATE THE SOFTWARE LICENSE OR LIMITED WARRANTY, CONTACT YOUR CISCO REPRESENTATIVE FOR A COPY.

The Cisco implementation of TCP header compression is an adaptation of a program developed by the University of California, Berkeley (UCB) as part of UCB's public domain version of the UNIX operating system. All rights reserved. Copyright © 1981, Regents of the University of California.

NOTWITHSTANDING ANY OTHER WARRANTY HEREIN, ALL DOCUMENT FILES AND SOFTWARE OF THESE SUPPLIERS ARE PROVIDED "AS IS" WITH ALL FAULTS. CISCO AND THE ABOVE-NAMED SUPPLIERS DISCLAIM ALL WARRANTIES, EXPRESSED OR IMPLIED, INCLUDING, WITHOUT LIMITATION, THOSE OF MERCHANTABILITY, FITNESS FOR A PARTICULAR PURPOSE AND NON-INFRINGEMENT OR ARISING FROM A COURSE OF DEALING, USAGE, OR TRADE PRACTICE.

IN NO EVENT SHALL CISCO OR ITS SUPPLIERS BE LIABLE FOR ANY INDIRECT, SPECIAL, CONSEQUENTIAL, OR INCIDENTAL DAMAGES, INCLUDING, WITHOUT LIMITATION, LOST PROFITS OR LOSS OR DAMAGE TO DATA ARISING OUT OF THE USE OR INABILITY TO USE THIS MANUAL, EVEN IF CISCO OR ITS SUPPLIERS HAVE BEEN ADVISED OF THE POSSIBILITY OF SUCH DAMAGES.

Any Internet Protocol (IP) addresses and phone numbers used in this document are not intended to be actual addresses and phone numbers. Any examples, command display output, network topology diagrams, and other figures included in the document are shown for illustrative purposes only. Any use of actual IP addresses or phone numbers in illustrative content is unintentional and coincidental.

All printed copies and duplicate soft copies of this document are considered uncontrolled. See the current online version for the latest version.

Cisco has more than 200 offices worldwide. Addresses and phone numbers are listed on the Cisco website at www.cisco.com/go/offices.

Cisco and the Cisco logo are trademarks or registered trademarks of Cisco and/or its affiliates in the U.S. and other countries. To view a list of Cisco trademarks, go to this URL: [www.cisco.com go trademarks](http://www.cisco.com/go/trademarks). Third-party trademarks mentioned are the property of their respective owners. The use of the word partner does not imply a partnership relationship between Cisco and any other company. (1721R)

© 2019 Cisco Systems, Inc. All rights reserved.



CONTENTS

PREFACE

About this Guide	xxix
Conventions Used	xxix
Related Documentation	xxxi
MIOs and DPCs	xxxi
Contacting Customer Support	xxxii

CHAPTER 1

System Operation and Configuration	1
System Management Overview	1
Terminology	3
Contexts	3
Ports	3
Logical Interfaces	4
Management Interface	4
Bindings	4
Services	4
AAA Servers	5
Subscribers	5
Trusted Builds	6
How the System Selects Contexts	6
Context Selection for Context-level Administrative User Sessions	7
Context Selection for Subscriber Sessions	10
Understanding the ASR 5500 Boot Process	10
Understanding Configuration Files	12
IP Address Notation	13
IPv4 Dotted-Decimal Notation	13
IPv6 Colon-Separated-Hexadecimal Notation	14

CIDR Notation	14
Alphanumeric Strings	15
Character Set	15
Quoted Strings	16

CHAPTER 2**Getting Started 17**

ASR 5500 Configuration	17
Using the ASR 5500 Quick Setup Wizard	17
The Quick Setup Wizard	18
Using the CLI for Initial Configuration	25
Configuring System Administrative Users	27
Limiting the Number of Concurrent CLI Sessions	27
Automatic Logout of CLI Sessions	27
Configuring the System for Remote Access	28
Configuring SSH Options	30
SSH Host Keys	31
Setting SSH Key Size	31
Configuring SSH Key Generation Wait Time	31
Specifying SSH Encryption Ciphers	32
MAC Algorithm Configuration	33
Generating SSH Keys	35
Setting SSH Key Pair	35
Authorized SSH User Access	36
Authorizing SSH User Access	36
SSH User Login Restrictions	36
Creating an Allowed Users List	37
SSH User Login Authentication	37
Secure Session Logout	38
Changing Default sshd Secure Session Logout Parameters	39
SSH Client Login to External Servers	39
Setting SSH Client Ciphers	39
Setting Preferred Authentication Methods	40
Generating SSH Client Key Pair	41
Pushing an SSH Client Public Key to an External Server	41

Enabling NETCONF 42

Configuring the Management Interface with a Second IP Address 42

CHAPTER 3**System Settings 45**

Configuring a Second Management Interface 45

Verifying and Saving Your Interface and Port Configuration 46

Configuring System Timing 47

Setting the System Clock and Time Zone 47

Verifying and Saving Your Clock and Time Zone Configuration 47

Configuring Network Time Protocol Support 48

Configuring NTP Servers with Local Sources 49

Using a Load Balancer 49

Verifying the NTP Configuration 49

Configuring SF Boot Configuration Pause 51

Enabling CLI Timestamping 51

Configuring CLI Confirmation Prompts 52

Enabling Automatic Confirmation 52

Requiring Confirmation for autoconfirm and configure Commands 52

Requiring Confirmation for Specific Exec Mode Commands 53

Configuring System Administrative Users 54

User Name Character Restrictions 54

Configuring Context-level Administrative Users 54

Configuring Context-level Security Administrators 55

Configuring Context-level Administrators 55

Configuring Context-level Operators 56

Configuring Context-level Inspectors 56

Configuring LI Administrators 57

Segregating System and LI Configurations 57

Verifying Context-level Administrative User Configuration 58

Configuring Local-User Administrative Users 59

Verifying Local-User Configuration 59

Updating Local-User Database 60

Updating and Downgrading the local-user Database 60

Provisioning Lawful Intercept 61

- Restricting User Access to a Specified Root Directory 62
 - Configuring an SFTP root Directory 62
 - Associating an SFTP root Directory with a Local User 62
 - Associating an SFTP root Directory with an Administrator 63
 - Associating an SFTP root Directory with a Config Administrator 63
- Configuring TACACS+ for System Administrative Users 63
 - Operation 63
 - User Account Requirements 64
 - TACACS+ User Account Requirements 64
 - StarOS User Account Requirements 65
 - Configuring TACACS+ AAA Services 65
 - Configuring TACACS+ for Non-local VPN Authentication 66
 - Verifying the TACACS+ Configuration 66
- IPv6 Address Support for TACACS+ Server 67
- Separating Authentication Methods 67
 - Disable TACACS+ Authentication for Console 67
 - Disable AAA-based Authentication for Console 68
 - Disable TACACS+ Authentication at the Context Level 68
 - Limit local-user Login on Console/vty Lines 69
 - Limit Console Access for AAA-based Users 69
 - Verify Configuration Changes 70
- Configuring a Chassis Key 70
 - Overview 70
 - Configuring a New Chassis Key Value 70
 - CLI Commands 70
 - Quick Setup Wizard 71
- Configuring MIO/UMIO/MIO2 Port Redundancy 72
 - Configuring MIO/UMIO/MIO2 Port Redundancy Auto-Recovery 74
 - Verifying Port Redundancy Auto-Recovery 74
- Configuring Data Processing Card Availability 75
 - Verifying Card Configurations 75
- Enabling Automatic Reset of FSC Fabric 76
- Configuring ASR 5500 Link Aggregation 76
 - LAG and Master Port 76

LAG and Port Redundancy	77
LAG and Multiple Switches	77
Multiple Switches with L2 Redundancy	77
Port States for Auto-Switch	78
Hold Time	78
Preferred Slot	78
Auto-Switch Criteria	79
Link Aggregation Control	79
Minimum Links	80
Redundancy Options	81
Horizontal Link Aggregation with Two Ethernet Switches	81
Non-Redundant (Active-Active) LAG	81
Faster Data Plane Convergence	82
Link Aggregation Status	83
Configuring a Demux Card	83
Overview	83
MIO Demux Restrictions	84
Configuration	85

CHAPTER 4

Config Mode Lock Mechanisms	87
Overview of Config Mode Locking	87
Requesting an Exclusive-Lock	88
Effect of Config Lock on URL Scripts	89
Saving a Configuration File	90
Reload and Shutdown Commands	90
show administrators Command	91

CHAPTER 5

Management Settings	93
ORBEM	93
Configuring ORBEM Client and Port Parameters	94
Configuring IIOP Transport Parameters	94
Verifying ORBEM Parameters	94
SNMP MIB Browser	95
SNMP Support	97

Configuring SNMP and Alarm Server Parameters 98
 Verifying SNMP Parameters 99
 Controlling SNMP Trap Generation 100

CHAPTER 6 **Verifying and Saving Your Configuration 101**

Verifying the Configuration 101
 Feature Configuration 101
 Service Configuration 102
 Context Configuration 102
 System Configuration 102
 Finding Configuration Errors 102
 Synchronizing File Systems 103
 Saving the Configuration 103

CHAPTER 7 **System Interfaces and Ports 105**

Contexts 105
 Creating Contexts 105
 Viewing and Verifying Contexts 106
 Ethernet Interfaces and Ports 106
 Creating an Interface 106
 Configuring a Port and Binding It to an Interface 107
 Configuring a Static Route for an Interface 107
 Viewing and Verifying Port Configuration 108
 VLANs 109
 Hypervisors 109
 VLANs and Management Ports 109

CHAPTER 8 **System Security 111**

Per-Chassis Key Identifier 111
 MIO Synchronization 112
 Protection of Passwords 112
 Secure Password Encryption 112
 Support for Non-Current Encryptions and Decryptions 113
 Support for ICSR Configurations 114

Encrypted SNMP Community Strings	114
Enhanced Password Security	114
Lawful Intercept Restrictions	114
LI Server Addresses	114
Modifying Intercepts	115
Adding, Modifying and Removing Users	115
Notification of Users Being Added or Deleted	115
Notification of Changes in Privilege Levels	115
User Access to Operating System Shell	116
Test-Commands	116
Enabling cli test-commands Mode	116
Enabling Password for Access to CLI-test commands	116
Exec Mode cli test-commands	117
Configuration Mode cli test-commands	117

CHAPTER 9

Secure System Configuration File	119
Feature Summary and Revision History	119
Feature Description	120
How System Configuration Files are Secured	120
Create a Digital Signature	120
Validate the Digital Signature	121
Configuring Signature Verification	121
Import RSA Public Key for Verification	121
Enable or Disable Signature Verification	122

CHAPTER 10

Software Management Operations	123
Understanding the Local File System	123
File Types Used by the Local File System	123
Understanding the boot.sys File	124
Maintaining the Local File System	124
File System Management Commands	124
Synchronizing the File System	125
Creating Directories	125
Renaming Files and Directories	125

Copying Files	125
Deleting Files	126
Removing Directories	126
Formatting Local Devices	126
Applying Pre-existing CLI Configuration Files	127
Viewing Files on the Local File System	127
Viewing the Contents of a Local Device	127
Viewing CLI Configuration and boot.sys Files	128
Validating an Operating System File	128
Configuring the Boot Stack	129
System Boot Methods	129
Viewing the Current Boot Stack	129
Adding a New Boot Stack Entry	131
Deleting a Boot Stack Entry	131
Network Booting Configuration Requirements	131
Configuring the Boot Interface	131
Configuring the Boot Network	132
Configuring Boot Network Delay Time	133
Configuring a Boot Nameserver	133
Upgrading the Operating System Software	133
Prerequisites	134
Obtain VIP Addresses for AutoVNF, CF, ESC and UEM	134
Identify OS Release Version and Build Number	136
Download the Software Image from the Support Site	137
Verify Zookeeper Database	137
Verify ESC Database	138
Verify Free Space on the /flash Device	139
Transfer StarOS Image to /flash	139
Saving a Copy of the Current Configuration File	141
Downgrading from Release 15.0 to 14.0	141
Downgrading from Release 20.0	142
Off-line Software Upgrade	142
Configure a Newcall Policy	143
Configure a Message of the Day Banner	143

Back up the Current CLI Configuration File	143
Save the Running Configuration	144
Create a New Boot Stack Entry	145
Synchronize File Systems	146
Reboot the System	146
Save the Running Configuration	150
Synchronize File Systems	152
Reboot the System	153
Restoring the Previous Software Image	157
Upgrading ICSR Chassis	157
Performing Dynamic Software Updates	157
Managing License Keys	158
New System License Keys	158
Session Use and Feature Use Licenses	158
Installing New License Keys	158
Cutting and Pasting the Key	159
Adding License Keys to Configuration Files	159
License Expiration Behavior	160
Requesting License Keys	160
Viewing License Information	161
Deleting a License Key	161
Management Card Replacement and License Keys	161
Managing Local-User Administrative Accounts	161
Configuring Local-User Password Properties	161
Configuring Local-User Account Management Properties	162
Local-User Account Lockouts	162
Local-User Account Suspensions	162
Changing Local-User Passwords	162
CHAPTER 11	Smart Licensing 165
Feature Summary and Revision History	165
Smart Software Licensing	166
Cisco Smart Software Manager	167
Smart Accounts/Virtual Accounts	167

- Request a Cisco Smart Account 167
- Software Tags and Entitlement Tags 168
- Configuring Smart Licensing 170
- Monitoring and Troubleshooting Smart Licensing 171
 - Smart Licensing Bulk Statistics 172

CHAPTER 12

- Monitoring the System 173**
 - SNMP Notifications 173
 - Monitoring System Status and Performance 173
 - Monitoring ASR 5500 Hardware Status 175
 - Clearing Statistics and Counters 177

CHAPTER 13

- Monitor Process Listing 179**
 - Feature Summary and Revision History 179
 - Feature Description 180
 - Monitoring and Troubleshooting 180
 - Show Command(s) and/or Outputs 180
 - show process status 180

CHAPTER 14

- Bulk Statistics 181**
 - Feature Summary and Revision History 181
 - Configuring Communication with the Collection Server 182
 - Configuring Standard Settings 182
 - Configuring Optional Settings 183
 - Configuring Bulk Statistic Schemas 183
 - Configuring a Separate Bulkstats Config File 183
 - Using show bulkstats Commands 184
 - Verifying Your Configuration 185
 - Saving Your Configuration 186
 - Viewing Collected Bulk Statistics Data 186
 - Collecting Bulk Statistics Samples in SSD 186
 - Manually Gathering and Transferring Bulk Statistics 186
 - Clearing Bulk Statistics Counters and Information 187
 - Bulkstats Schema Nomenclature 187

Statistic Types	187
Data Types	188
Key Variables	188
Bulk Statistics Event Log Messages	190

CHAPTER 15
System Logs 193

Feature Summary and Revision History	193
System Log Types	194
Configuring Event Logging Parameters	195
Configuring Event Log Filters	196
Exec Mode Filtering	196
Global Configuration Mode Filtering	198
Configuring Syslog Servers	199
Configuring Active Logs	200
Specifying Facilities	201
Configuring Trace Logging	210
Configuring Monitor Logs	210
Enabling Monitor Logs	210
Disabling Monitor Logs	210
Viewing Logging Configuration and Statistics	211
Viewing Event Logs Using the CLI	212
Configuring and Viewing Crash Logs	212
Crash Logging Architecture	213
Configuring Software Crash Log Destinations	213
Viewing Abridged Crash Log Information Using the CLI	214
Reducing Excessive Event Logging	215
Configuring Log Source Thresholds	216
Checkpointing Logs	216
Saving Log Files	217
Event ID Overview	217
Event Severities	227
Understanding Event ID Information in Logged Output	228

CHAPTER 16
Troubleshooting 229

Detecting Faulty Hardware	229
Licensing Issues	229
Using the CLI to View Status LEDs	230
Checking the LEDs on the PFU	230
Checking the LEDs on the MIO Card	231
MIO Run/Fail LED States	232
MIO Active LED States	233
MIO Redundancy LED States	234
MIO Master LED States	234
MIO Busy LED States	235
MIO – Interface Link LED States	235
MIO – Interface Activity LED States	236
Checking the LEDs on the DPC	236
DPC Run/Fail LED States	237
DPC Active LED States	238
DPC Redundancy LED States	239
Checking the LEDs on the FSC	240
FSC Run/Fail LED States	240
FSC Active LED States	241
FSC Redundancy LED States	242
FSC Drive n Activity LED States	242
Checking the LEDs on the SSC	243
SSC Run/Fail LED States	244
SSC Active LED States	245
SSC Redundancy LED States	246
SSC System Status LED States	246
SSC System Service LED States	247
Testing System Alarm Outputs	247
Taking Corrective Action	248
Switching MIOs	248
Busying Out a DPC	248
Migrating a DPC	249
Halting Cards	249
Initiate a Card Halt	250

Restore a Previously Halted Card	250
Verifying Network Connectivity	251
Using the ping or ping6 Command	251
Syntax	251
Troubleshooting	251
Using the traceroute or traceroute6 Command	252
traceroute – IPv4	252
traceroute6 – IPv6	252
Viewing IP Routes	253
Viewing the Address Resolution Protocol Table	253
Using the System Diagnostic Utilities	254
Using the Monitor Utility	254
Using the Protocol Monitor	254
Using the Protocol Monitor for a Specific Subscriber	255
Generating an SSD	257
Configuring and Using the Support Data Collector	257

CHAPTER 17

Packet Capture (PCAP) Trace	259
Feature Information	259
Feature Description	260
Configuring PCAP Trace	260
Enabling Multiple Instances of CDRMOD	260
Configuring the Hexdump Module	261
Configuring the Hexdump File Parameters	263
Enabling or Disabling Hexdump	266
Enabling PCAP Trace for MME	266
Monitoring and Troubleshooting PCAP Trace	267
Show Command(s) and/or Outputs	267
show cdr statistics	267
show { hexdump-module cdr } file-space-usage	268
show hexdump-module statistics	269

CHAPTER 18

System Recovery	273
Prerequisites	273

Console Access	273
Boot Image	273
Accessing the boot CLI	274
Initiate a Reboot	274
Interrupt the Boot Sequence	274
Enter CLI Mode	275
boot Command Syntax	275
Booting from a Selected Image	275
Boot Using No Configuration File	275
Boot Using A Specified Configuration File	276

CHAPTER 19

Access Control Lists	277
Overview	277
Understanding ACLs	278
Rule(s)	278
Actions	278
Criteria	278
Rule Order	279
Configuring ACLs on the System	280
Creating ACLs	280
Configuring Action and Criteria for Subscriber Traffic	281
Configuring an Undefined ACL	281
Verifying the ACL Configuration	281
Applying IP ACLs	282
Applying the ACL to an Interface	283
Applying an ACL to an Individual Interface	284
Verifying the ACL Configuration on an Interface	284
Applying the ACL to a Context	285
Applying an ACL to All Traffic Within a Context	285
Verifying the ACL Configuration in a Context	286
Applying an ACL to a RADIUS-based Subscriber	286
Applying an ACL to an Individual Subscriber	287
Verifying the ACL Configuration to an Individual Subscriber	287
Applying an ACL to the Subscriber Named default	288

Applying an ACL to the Subscriber Named default	288
Verifying the ACL Configuration to the Subscriber Named default	289
Applying an ACL to Service-specified Default Subscriber	290
Applying an ACL to Service-specified Default Subscriber	290
Verifying the ACL Configuration to Service-specified Default Subscriber	290
Applying a Single ACL to Multiple Subscribers	291
Applying an ACL to Multiple Subscriber via APNs	292

CHAPTER 20**Congestion Control 295**

Overview	295
Configuring Congestion Control	296
Configuring the Congestion Control Threshold	296
Configuring Service Congestion Policies	297
Configuring Overload Reporting on the MME	297
Enabling Congestion Control Redirect Overload Policy	298
Verify the Service Overload Policies	298
Verify the Congestion Control Configuration	298
Verify MME Congestion Action Profiles	298
Disconnecting Subscribers Based on Call or Inactivity Time	298

CHAPTER 21**Routing 301**

Routing Policies	301
Creating IP Prefix Lists	302
Creating Route Access Lists	302
Creating AS Path Access Lists	302
Creating Route Maps	302
Sample Configuration	303
Static Routing	303
Adding Static Routes to a Context	304
Deleting Static Routes From a Context	304
OSPF Routing	304
OSPF Version 2 Overview	305
Basic OSPFv2 Configuration	306
Enabling OSPF Routing For a Specific Context	306

Enabling OSPF Over a Specific Interface	306
Redistributing Routes Into OSPF (Optional)	306
Confirming OSPF Configuration Parameters	306
OSPFv3 Routing	307
OSPFv3 Overview	307
Basic OSPFv3 Configuration	307
Enabling OSPFv3 Routing For a Specific Context	307
Enabling OSPFv6 Over a Specific Interface	307
Redistributing Routes Into OSPFv3 (Optional)	308
Confirming OSPFv3 Configuration Parameters	308
Equal Cost Multiple Path (ECMP)	308
BGP-4 Routing	308
Overview of BGP Support	309
Configuring BGP	310
Redistributing Routes Into BGP (Optional)	310
BGP Communities and Extended Communities	310
BGP Communities	311
BGP Extended Communities	312
BGP Local Preference	313
ICSR and SRP Groups	313
Advertising BGP Routes from a Standby ICSR Chassis	313
Configurable BGP Route Advertisement Interval for ICSR	314
BGP CLI Configuration Commands	314
Confirming BGP Configuration Parameters	316
BGP Peer Limit	316
Feature Summary and Revision History	316
Feature Description	316
How It Works	317
Configuring BGP Peer Limit	317
Monitoring and Troubleshooting	318
Bidirectional Forwarding Detection	318
Overview of BFD Support	319
Configuring BFD	319
Configuring a BFD Context	319

Configuring IPv4 BFD for Static Routes	320
Configuring IPv6 BFD for Static Routes	320
Configuring BFD for Single Hop	320
Configuring Multihop BFD	321
Scaling of BFD	321
Associating BGP Neighbors with the Context	321
Associating OSPF Neighbors with the Context	322
Associating BFD Neighbor Groups with the BFD Protocol	322
Enabling BFD on OSPF Interfaces	322
Monitoring BFD Connection for ICSR	322
Saving the Configuration	323
Chassis-to-Chassis BFD Monitoring for ICSR	323
Enable Primary Chassis BFD Monitoring	323
Set BFD to Ignore ICSR Dead Interval	323
Configure ICSR Switchover Guard Timer	324
Enable BFD Multihop Fall-over	324
Adjust BFD Interval	325
Enable Advertising BGP Routes from Standby ICSR Chassis	326
Saving the Configuration	326
BFD Support for Link Aggregation Member Links	326
Overview	326
Configuring Support for BFD Linkagg Member-links	327
Saving the Configuration	327
Viewing Routing Information	327

CHAPTER 22
VLANs 329

Overview	329
Overlapping IP Address Pool Support – GGSN	329
RADIUS VLAN Support – Enhanced Charging Services	330
APN Support – PDN Gateway (P-GW)	330
Creating VLAN Tags	331
Verifying the Port Configuration	331
Configuring Subscriber VLAN Associations	332
RADIUS Attributes Used	332

Configuring Local Subscriber Profiles	332
Verify the Subscriber Profile Configuration	333
VLAN-Related CLI Commands	333

CHAPTER 23**BGP MPLS VPNs 337**

Introduction	337
MPLS-CE Connected to PE	338
ASR 5500 as a PE	338
Overview	338
Sample Configuration	339
IPv6 Support for BGP MPLS VPNs	340
Overview	340
Sample Configuration	341
VPN-Related CLI Commands	343

CHAPTER 24**Content Service Steering 349**

Overview	349
Configuring Internal Content Service Steering	349
Defining IP Access Lists for Internal CSS	350
Applying an ACL to an Individual Subscriber (Optional)	351
Applying an ACL to Multiple Subscribers (Optional)	351
Applying an ACL to the Subscriber Named default (Optional)	351
Applying an ACL to Service-specified Default Subscribers (Optional)	351
Applying an ACL to Multiple Subscribers via APNs (Optional)	351

CHAPTER 25**Session Recovery 353**

How Session Recovery Works	353
Additional ASR 5500 Hardware Requirements	356
Configuring the System to Support Session Recovery	356
Enabling Session Recovery	357
Enabling Session Recovery on an Out-of-Service System	357
Enabling Session Recovery on an In-Service System	357
Disabling the Session Recovery Feature	358
Viewing Session Recovery Status	358

Viewing Recovered Session Information	359
Recovery Control Task Statistics	360
show rct stats Command	361
Sample Output for show rct stats verbose	361
<hr/>	
CHAPTER 26	Interchassis Session Recovery 363
Overview	363
Interchassis Communication	364
Checkpoint Messages	365
SRP CLI Commands	365
Exec Mode CLI Commands	365
show Commands	366
AAA Monitor	366
BGP Interaction	367
Requirements	367
ICSR Operation	368
Chassis Initialization	371
Chassis Operation	371
Chassis Communication	371
Chassis Switchover	371
Configuring ICSR	372
Configuring the Service Redundancy Protocol (SRP) Context	373
Creating and Binding the SRP Context	373
Configuring SRP Context Parameters	374
Optimizing Switchover Transitions	376
Configuring the SRP Context Interface Parameters	379
Configuring NACK Generation for SRP Checkpoint Messaging Failures	380
Configuring LZ4 Compression Algorithm	381
Reducing Sync-Up Time with Standby ICSR Chassis	381
Verifying SRP Configuration	382
Modifying the Source Context for ICSR	382
Configuring BGP Router and Gateway Address	382
Configuring the SRP Context for BGP	383
Verifying BGP Configuration	383

Modifying the Destination Context for ICSR	383
Configuring BGP Router and Gateway Address in Destination Context	384
Configuring SRP Context for BGP for Destination Context	384
Setting Subscriber to Default Mode	384
Verifying BGP Configuration in Destination Context	384
Disabling Bulk Statistics Collection on a Standby System	385
Verifying the Primary and Backup Configuration	385
Configuring Subscriber State Management Audit Process	386
Troubleshooting ICSR Operation	386
Updating the Operating System	387
Both ICSR Systems	391
Downloading and Transferring the StarOS Image	391
Standby ICSR System	392
Performing Health Checks	392
Performing SRP Checks	392
Performing BGP Checks	392
Updating the Boot Record	393
Synchronizing File Systems	393
Reboot StarOS	393
Updating the Configuration File	394
Verifying the Software Version	394
Saving the Configuration File	394
Completing the Update Process	394
Waiting for Session Synchronization	394
Primary System	394
Initiating an SRP Switchover	394
Checking AAA Monitor Status on the Newly Active System	395
Completing the Software Update	395
Initiating an SRP Switchover	395
Making Test Calls	396
Fallback Procedure	396
CHAPTER 27	Support Data Collector 397
	Overview 397

Configuring SDR Collection	398
Displaying the SDR Collection Configuration	398
Collecting and Storing the SDR Information	399
Managing Record Collection	399
Using SDRs to Diagnose Problems	401
SDR CLI Commands	401
Configuration Commands (Global Configuration Mode)	402
support record	402
support collection	402
Exec Mode Commands	403
show support record	403
delete support record	403
show support collection	403

APPENDIX A

Engineering Rules	405
CLI Session Rules	405
ASR 5500 Interface and Port Rules	405
Packet Data Network (PDN) Interface Rules	406
Context Rules	406
Subscriber Rules	409
Service Rules	410
Access Control List (ACL) Engineering Rules	410
ECMP Groups	411
VPN Scaling Requirements	411

APPENDIX B

StarOS Tasks	415
Overview	415
Primary Task Subsystems	415
Controllers and Managers	417
Subsystem Tasks	417
System Initiation Subsystem	418
High Availability Subsystem	419
Resource Manager Subsystem	420
Virtual Private Networking Subsystem	421

Network Processing Unit Subsystem 423
 Session Subsystem 425
 Platform Processes 439
 Management Processes 443

APPENDIX C

NETCONF and ConfD 445
 Feature Summary and Revision History 445
 Overview 446
 Configuring ConfD 448
 SSH Key Requirement 448
 NETCONF Protocol Configuration Mode 448
 bulkstats 449
 confd-user 449
 kpi 449
 netconf notifications events 450
 netconf notifications snmp 450
 netconf port 450
 rest auth-policy 450
 rest certificate 451
 rest hostname 452
 rest port 452
 Sample Configuration 452
 Verifying the Configuration 453
 show confdmgr Command 453
 clear confdmgr confd cdb 458
 clear confdmgr statistics 459
 YANG Models 459
 Show Support Details (SSD) 460
 ConfD Examples 460
 Server ConfD 460
 Bulkstats 462
 Exec CLI Model 464
 ConfD Upgrade Support 465
 CLI Based YANG Model for ECS Commands 465

Seeding and Synchronizing the CDB	466
show configuration confd Command	466
CDB Maintenance	467
clear confdmgr confd cdb	467
configure confd <url>	467
save configuration <url> confd	468
Supported StarOS ECS Configuration Commands	468

APPENDIX D
ICSR Checkpointing 471

Overview of Checkpointing	471
Macro-checkpoints	471
GGSN_APN ID MAPPING	472
INSTANCE LEVEL CHECKPOINT	472
SERVICE_ID MAPPING	472
VPNMGR_ID MAPPING	472
Micro-checkpoints	473
Uncategorized	473
SESS_UCHKPT_CMD_INVALIDATE_CRR	473
SESS_UCHKPT_CMD_UPDATE_CLPSTATS	473
SESS_UCHKPT_CMD_UPDATE_IDLESECS	474
DCCA Category	474
SESS_UCHKPT_CMD_DCCA_SESS_INFO	474
ECS Category	474
SESS_UCHKPT_CMD_ACS_CALL_INFO	474
SESS_UCHKPT_CMD_ACS_GX_LI_INFO	475
SESS_UCHKPT_CMD_ACS_SESS_INFO	475
SESS_UCHKPT_CMD_DEL_ACS_CALL_INFO	475
SESS_UCHKPT_CMD_DEL_ACS_SESS_INFO	475
SESS_UCHKPT_CMD_DYNAMIC_CHRG_CA_INFO	476
SESS_UCHKPT_CMD_DYNAMIC_CHRG_DEL_CA_INFO	476
SESS_UCHKPT_CMD_DYNAMIC_CHRG_DEL_QG_INFO	476
SESS_UCHKPT_CMD_DYNAMIC_CHRG_QG_INFO	476
SESS_UCHKPT_CMD_DYNAMIC_RULE_DEL_INFO	477
SESS_UCHKPT_CMD_DYNAMIC_RULE_INFO	477

ePDG Category	477
SESS_UCHKPT_CMD_DELETE_EPDG_BEARER	477
SESS_UCHKPT_CMD_UPDATE_EPDG_BEARER	478
SESS_UCHKPT_CMD_UPDATE_EPDG_PEER_ADDR	478
SESS_UCHKPT_CMD_UPDATE_EPDG_REKEY	478
SESS_UCHKPT_CMD_UPDATE_EPDG_STATS	478
Firewall/ECS Category	479
SESS_UCHKPT_CMD_SFW_DEL_RULE_INFO	479
SESS_UCHKPT_CMD_SFW_RULE_INFO	479
GGSN Category	479
SESS_UCHKPT_CMD_GGSN_DELETE_SUB_SESS	479
SESS_UCHKPT_CMD_GGSN_UPDATE_RPR	480
SESS_UCHKPT_CMD_GGSN_UPDATE_SESSION	480
SESS_UCHKPT_CMD_GGSN_UPDATE_STATS	480
SESS_UCHKPT_CMD_UPDATE_COA_PARAMS	480
Gx Interface Category	481
SESS_UCHKPT_CMD_ACS_VOLUME_USAGE	481
SESS_UCHKPT_CMD_UPDATE_SGX_INFO	481
NAT Category	481
SESS_UCHKPT_CMD_GR_UPDATE_NAT_REALM_PORT_INFO	481
SESS_UCHKPT_CMD_GR_UPDATE_NAT_REALMS	482
SESS_UCHKPT_CMD_NAT_SIP_ALG_CALL_INFO	482
SESS_UCHKPT_CMD_NAT_SIP_ALG_CONTACT_PH_INFO	482
SESS_UCHKPT_CMD_UPDATE_DSK_FLOW_CHKPT_INFO	483
SESS_UCHKPT_CMD_UPDATE_NAT_BYPASS_FLOW_INFO	483
P-GW Category	483
SESS_UCHKPT_CMD_PGW_DELETE_SUB_SESS	483
SESS_UCHKPT_CMD_PGW_OVRCHRG_PRTCTN_INFO	483
SESS_UCHKPT_CMD_PGW_SGWRESTORATION_INFO	484
SESS_UCHKPT_CMD_PGW_UBR_MBR_INFO	484
SESS_UCHKPT_CMD_PGW_UPDATE_APN_AMBR	484
SESS_UCHKPT_CMD_PGW_UPDATE_INFO	484
SESS_UCHKPT_CMD_PGW_UPDATE_LI_PARAM	484
SESS_UCHKPT_CMD_PGW_UPDATE_PDN_COMMON_PARAM	485

SESS_UCHKPT_CMD_PGW_UPDATE_QOS	485
SESS_UCHKPT_CMD_PGW_UPDATE_SGW_CHANGE	485
SESS_UCHKPT_CMD_PGW_UPDATE_STATS	485
Rf Interface Category	485
SESS_UCHKPT_CMD_ACS_ACCOUNTING_TYPE_QCI_RF	485
SESS_UCHKPT_CMD_ACS_ACCOUNTING_TYPE_QCI_RF_WITH_FC	486
SESS_UCHKPT_CMD_ACS_ACCOUNTING_TYPE_RATING_GROUP_RF	486
SESS_UCHKPT_CMD_ACS_ACCOUNTING_TYPE_RATING_GROUP_RF_WITH_FC	486
S6b Interface Category	486
SESS_UCHKPT_CMD_S6B_INFO	486
SaMOG Category	487
SESS_UCHKPT_CMD_CGW_DELETE_BEARER	487
SESS_UCHKPT_CMD_CGW_DELETE_PDN	487
SESS_UCHKPT_CMD_CGW_UPDATE_BEARER_QOS	487
SESS_UCHKPT_CMD_CGW_UPDATE_PDN	487
SESS_UCHKPT_CMD_CGW_UPDATE_STATS	488
SESS_UCHKPT_CMD_CGW_UPDATE_UE_PARAM	488
SESS_UCHKPT_CMD_SAMOG_ACCT_INTERIM_INFO	488
SESS_UCHKPT_CMD_SAMOG_ACCT_START_INFO	488
SESS_UCHKPT_CMD_SAMOG_EOGRE_TUNNEL_INFO	488
SESS_UCHKPT_CMD_SAMOG_GTPV1_UPDATE_PDN_INFO	489
SESS_UCHKPT_CMD_SAMOG_HANDOFF_AUTHEN_INFO	489
SESS_UCHKPT_CMD_SAMOG_HANDOFF_INIT_INFO	489
SESS_UCHKPT_CMD_SAMOG_LI_PROV_INFO	490
SESS_UCHKPT_CMD_SAMOG_MIPV6_TIMER_INFO	490
SESS_UCHKPT_CMD_SAMOG_MULTI_ROUND_AUTHEN_INFO	490
SESS_UCHKPT_CMD_SAMOG_REAUTHEN_INFO	490
SESS_UCHKPT_CMD_SAMOG_REAUTHOR_INFO	491

APPENDIX E **ASR 5500 SDR CLI Command Strings** 493

APPENDIX F **Cisco Secure Boot** 509

- Fundamental Concepts 509
- Secure Boot Overview 509

MIO2 Support for Secure Boot 510
Image Naming Conventions 510
Verifying Authenticity 510



About this Guide

This preface describes the *ASR 5500 System Administration Guide*, how it is organized and its document conventions.

The *System Administration Guide* describes how to generally configure and maintain StarOS running on an ASR 5500 platform. It also includes information on monitoring system performance and troubleshooting.

- [Conventions Used, on page xxix](#)
- [Related Documentation, on page xxxi](#)
- [MIOs and DPCs, on page xxxi](#)
- [Contacting Customer Support, on page xxxii](#)

Conventions Used

The following tables describe the conventions used throughout this documentation.

Notice Type	Description
Information Note	Provides information about important features or instructions.
Caution	Alerts you of potential damage to a program, device, or system.
Warning	Alerts you of potential personal injury or fatality. May also alert you of potential electrical hazards.

Typeface Conventions	Description
Text represented as a screen display	This typeface represents displays that appear on your terminal screen, for example: Login:

Typeface Conventions	Description
Text represented as commands	<p>This typeface represents commands that you enter, for example:</p> <p>show ip access-list</p> <p>This document always gives the full form of a command in lowercase letters. Commands are not case sensitive.</p>
Text represented as a command variable	<p>This typeface represents a variable that is part of a command, for example:</p> <p>show card slot_number</p> <p><i>slot_number</i> is a variable representing the desired chassis slot number.</p>
Text represented as menu or sub-menu names	<p>This typeface represents menus and sub-menus that you access within a software application, for example:</p> <p>Click the File menu, then click New</p>
Command Syntax Conventions	Description
{ keyword or <i>variable</i> }	<p>Required keyword options and variables are those components that are required to be entered as part of the command syntax.</p> <p>Required keyword options and variables are surrounded by grouped braces { }. For example:</p> <p>setp-max-data-chunks { limit max_chunks mtu-limit }</p> <p>If a keyword or variable is not enclosed in braces or brackets, it is mandatory. For example:</p> <p>snmp trap link-status</p>
[keyword or <i>variable</i>]	<p>Optional keywords or variables, or those that a user may or may not choose to use, are surrounded by brackets.</p>

Command Syntax Conventions	Description
	<p>Some commands support multiple options. These are documented within braces or brackets by separating each option with a vertical bar.</p> <p>These options can be used in conjunction with required or optional keywords or variables. For example:</p> <pre>action activate-flow-detection { initiation termination }</pre> <p>or</p> <pre>ip address [count number_of_packets size number_of_bytes]</pre>

Related Documentation

The most up-to-date information for this product is available in the product *Release Notes* provided with each software release.

The following user documents are available on www.cisco.com:

- *ASR 5500 Installation Guide*
- *AAA Interface Administration and Reference*
- *Command Line Interface Reference*
- *GTPP Interface Administration and Reference*
- *IPSec Reference*
- *Release Change Reference*
- *SNMP MIB Reference*
- *Statistics and Counters Reference*
- *Thresholding Configuration Guide*
- Product-specific and feature-specific Administration guides

MIOs and DPCs

The ASR 5500 supports a variety of Management Input/Output and Data Processing Card types.

The currently supported Management Input/Output card types include:

- Management Input/Output (MIO)
- Universal Management Input/Output (UMIO)
- Management Input/Output version 2 (MIO2)

MIO and UMIO card types differ only by the UMIO requirement for a Universal chassis license. The MIO2 is only supported on ASR 5500 running StarOS release 20.0+.

The currently supported Data Processing Card types include:

- Data Processing Card (DPC)

- Universal Data Processing Card (UDPC)
- Data Processing Card version 2 (DPC2)
- Universal Data Processing Card version 2 (UDPC2)

DPC and UDPC card types differ only by the UDPC requirement for a Universal chassis license. DPC2 and UDPC2 card types differ only by the UDPC2 requirement for a Universal chassis license. The DPC2/UDPC2 is only supported on ASR 5500 running StarOS release 18.2+.

When reference is made to an MIO card or DPC in this guide, it is presumed to apply to all types of these cards as identified above.

Contacting Customer Support

Use the information in this section to contact customer support.

Refer to the support area of <http://www.cisco.com> for up-to-date product documentation or to submit a service request. A valid username and password are required to access this site. Please contact your Cisco sales or service representative for additional information.



CHAPTER 1

System Operation and Configuration

The ASR 5500 is designed to provide subscriber management services for Mobile Packet Core networks.

Before you connect to the command line interface (CLI) and begin system configuration, you must understand how the system supports these services. This chapter provides terminology and background information to consider before you configure the system.

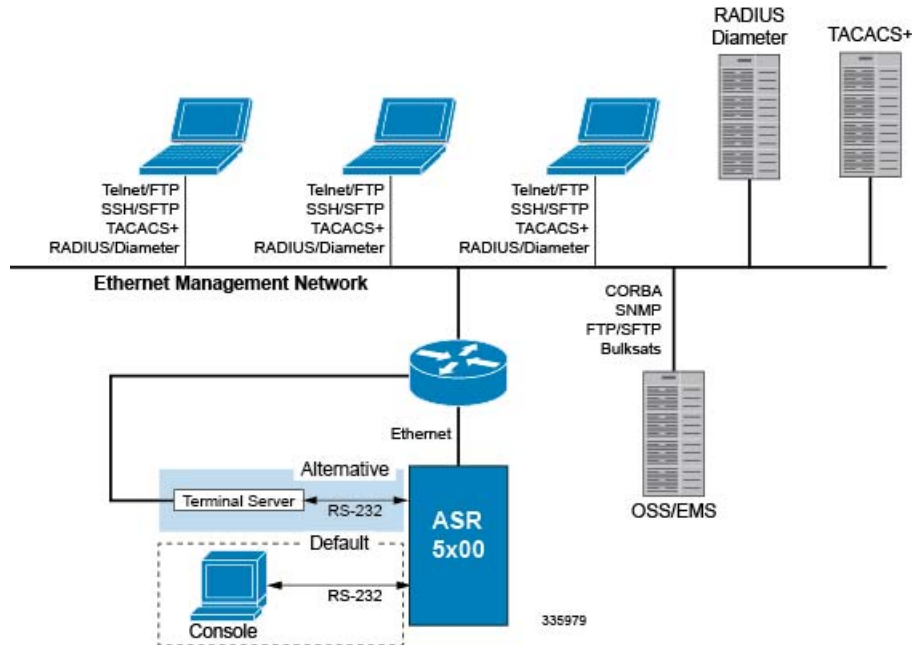
- [System Management Overview, on page 1](#)
- [Terminology, on page 3](#)
- [Trusted Builds, on page 6](#)
- [How the System Selects Contexts, on page 6](#)
- [Understanding the ASR 5500 Boot Process, on page 10](#)
- [Understanding Configuration Files, on page 12](#)
- [IP Address Notation, on page 13](#)
- [Alphanumeric Strings, on page 15](#)

System Management Overview

ASR 5500 management capabilities reflect the requirements of the Telecommunications Management Network (TMN) model for network element (NE) and element management system (EMS) functions. The system also supports external element management applications via standards-based protocols (CORBA and SNMPv1, v2). Wireless operators can readily integrate the ASR 5500 into their overall network, service, and business management systems. All management is performed out-of-band for security and to maintain system performance.

There are multiple ways to manage the system either locally or remotely using its out-of-band management interfaces.

Figure 1: System Management Interfaces



Management options include:

- Local login through the Console port on the MIO/MIO2 card using an RS-232 Console connection (RJ45) directly or indirectly via a terminal server
- Remote login using Telnet, and Secure Shell (SSH) access to the CLI through the MIO/MIO2 card's Ethernet management interfaces:
 - Two autosensing RJ45 10/100/1000Base-T (IEEE 802.3ab) shielded twisted-pair (STP) ports



Important In release 20.0 and higher Trusted StarOS builds, the Telnet and FTP options are not available.

- The MIO2 card also supports two 10 GbE ports that accept 10GBase-SR fiber optic-to-electrical signal Small Form-Factor Pluggable (SFP+) transceivers. These ports are intended for local context only offload of data records and bulk statistics.
- Support for Common Object Request Broker Architecture (CORBA) via an Object Request Broker Element Manager (ORBEM) interface and Simple Network Management Protocol version 1 (SNMPv1) and version 2 (SNMPv2) for fault management
- Authentication via RADIUS/Diameter or TACACS+

The StarOS CLI provides complete Fault, Configuration, Accounting, Performance, and Security (FCAPS) capabilities as described in the remaining chapters of this guide.



Important By default StarOS supports local Console access to the CLI via the RS-232 Console port for initial system configuration.

Terminology

This section defines important terms used throughout this guide.

Contexts

A context is a logical grouping or mapping of configuration parameters that pertain to various physical ports, logical IP interfaces, and services. A context can be thought of as a virtual private network (VPN).

The system supports the configuration of multiple contexts. Each context is configured and operates independently of the others. Once a context has been created, administrative users can configure services, logical IP interfaces, and subscribers for that context and then bind the logical interfaces to physical ports.

You can also assign a domain alias to a context; if a subscriber's domain name matches one of the configured alias names for a context, that context is used.

Ports

Ports are the physical connectors on line cards that support remote access and subscriber traffic. Port configuration includes traffic profiles, data encapsulation methods, media type, and other information for physical connectivity between the system and the rest of the network.

Ports are identified by the chassis slot number for the Management Input/Output (MIO/UMIO/MIO2) card, followed by the physical connector number. For example, Port 5/10 identifies connector number 10 on the MIO/UMIO/MIO2 card in slot 5.

Associate ports with contexts through bindings. For additional information on bindings, refer to the *Bindings* section below. You can configure each physical port to support multiple logical IP interfaces, each with up to 17 IP addresses (one primary and up to 16 secondaries).

For complete information on line cards and port assignments, refer to the *ASR 5500 Installation Guide*.



Important UMIO cards and UDPC/UDPC2s are direct replacements for MIO cards and DPC/DPC2s. However, a special Universal PID license must be purchased and installed on the chassis for each installed UMIO and UDPC/UDPC2. Contact your Cisco account representative for additional licensing information.



Important Throughout this guide, any reference to an MIO card or DPC is assumed to also refer to the UMIO and UDPC/UDPC2 respectively.

Logical Interfaces

You must associate a port with a StarOS virtual circuit or tunnel called a *logical interface* before the port can allow the flow of user data. Within StarOS, a logical interface is a named interface associated with a virtual router instance that provides higher-layer protocol transport, such as Layer 3 IP addressing. Interfaces are configured as part of VPN contexts and are independent from the physical ports that will be used to bridge the virtual interfaces to the network.

Logical interfaces are associated with ethernet+ppp+tunnel addresses and are bound to a specific port during the configuration process. Logical interfaces are also associated with services through bindings. Services are bound to an IP address that is configured for a particular logical interface. When associated, the interface takes on the characteristics of the functions enabled by the service.

There are several types of logical interfaces to configure to support Simple and Mobile IP data applications. These are briefly defined below.

Management Interface

This interface provides the point of attachment to the management network. The interface supports remote access to the StarOS command line interface (CLI). It also supports event notification via the Simple Network Management Protocol (SNMP).

Define management interfaces in the *local* context and bind them to the ports on the Management Input/Output (MIO/UMIO/MIO2) cards.

Bindings

A binding is an association between elements within the system. There are two types of bindings: static and dynamic.

Static binding is accomplished through system configuration. Static bindings associate:

- A specific logical interface (configured within a particular context) to a physical port. Once the interface is bound, traffic can flow through the context as if it were any physically-defined circuit. Static bindings support any encapsulation method over any interface and port type.
- A service to an IP address assigned to a logical interface within the same context. This allows the interface to take on the characteristics (that is, support the protocols) required by the service.

Dynamic binding associates a subscriber to a specific egress context based on the configuration of their profile or system parameters. This provides a higher degree of deployment flexibility, as it allows a wireless carrier to support multiple services and facilitates seamless connections to multiple networks.

Management ports can only be bound in the local context. Traffic or subscriber ports can only be bound in a non-local context.

Services

Configure services within a context to enable certain functionality. The following are examples of services you can configure on the system, subject to licensing availability and platform type:

- Gateway GPRS Support Node (GGSN) services
- Serving GPRS Support Node (SGSN) Services
- Packet Data Serving Node (PDSN) services

- Home Agent (HA) services
- Layer 2 Tunneling Protocol Access Concentrator (LAC) services
- Dynamic Host Control Protocol (DHCP) services
- Mobility Management Entity (MME) Services
- PDN Gateway (P-GW) Services
- Serving Gateway (S-GW) Services
- Intelligent Policy Control Function (IPCF) Services (PCC-Service, PCC-Policy, PCC-AF)

AAA Servers

Authentication, Authorization and Accounting (AAA) servers store profiles, perform authentication, and maintain accounting records for each mobile data subscriber. The AAA servers communicate with the system over an AAA interface. The system supports the configuration of up to 128 interfaces to AAA servers.

It is important to note that for Mobile IP, there can be Foreign AAA (FAAA) and Home AAA (HAAA) servers. FAAA servers typically reside in the carrier's network. HAAA servers could be owned and controlled by either the carrier or the home network. If the HAAA server is owned and controlled by the home network, accounting data is transferred to the carrier via an AAA proxy server.



Important

Mobile IP support depends on the availability and purchase of a license bundle that includes Home Agent (HA).

Subscribers

Subscribers are the end-users of the service; they gain access to the Internet, their home network, or a public network through the system.

There are three primary types of subscribers:

- **RADIUS-based Subscribers:** The most common type of subscriber, these users are identified by their International Mobile Subscriber Identity (IMSI) number, an Electronic Serial Number (ESN), or by their domain name or user name. They are configured on and authenticated by a RADIUS AAA server.

Upon successful authentication, various attributes that are contained in the subscriber profile are returned. The attributes dictate such things as session parameter settings (for example, protocol settings and IP address assignment method), and what privileges the subscriber has.



Important

Attribute settings received by the system from a RADIUS AAA server take precedence over local-subscriber attributes and parameters configured on the system.

- **Local Subscribers:** These are subscribers, primarily used for testing purposes, that are configured and authenticated within a specific context. Unlike RADIUS-based subscribers, the local subscriber's user profile (containing attributes like those used by RADIUS-based subscribers) is configured within the context where they are created.

When local subscriber profiles are first created, attributes for that subscriber are set to the system's default settings. The same default settings are applied to all subscriber profiles, including the subscriber named *default* which is created automatically by the system for each system context. When configuring local profile attributes, the changes are made on a subscriber-by-subscriber basis.



Important Attributes configured for local subscribers take precedence over context-level parameters. However, they *could* be over-ridden by attributes returned from a RADIUS AAA server.

- **Management Subscribers:** A management user is an authorized user who can monitor, control, and configure the system through the CLI. Management is performed either locally, through the system Console port, or remotely through the use of the Telnet or secure shell (SSH) protocols. Management users are typically configured as a local subscriber within the Local context, which is used exclusively for system management and administration. As with a local subscriber, a management subscriber's user profile is configured within the context where the subscriber was created (in this case, the Local context). However, management subscribers may also be authenticated remotely via RADIUS, if an AAA configuration exists within the local context, or TACACS+.

Trusted Builds

A Trusted build is a starfile image from which non-secure or low security features have been deleted or disabled. However, the binaries in the Trusted starfile image are identical to those found in other starfiles for a particular StarOS release-build number. In general, a Trusted build is more restrictive than a Normal build image.

You can identify whether your platform is running a Trusted build via the Exec mode **show version** command. The output of the command displays the word "Trusted" as part of the image description text.

The following non-secure programs and features are disabled/removed from a Trusted build:

- Telnet
- FTP (File Transfer Protocol)
- Local user database access
- **tcpdump** utility
- **rlogin** (Remote Login) utility and **rlogind** (Remote Login daemon)
- **rsh** (Remote Shell) and **rcp** (Remote Copy) utilities

How the System Selects Contexts

This section describes the process that determines which context to use for context-level administrative users or subscriber sessions. Understanding this process allows you to better plan your configuration in terms of how many contexts and interfaces you need to configure.

Context Selection for Context-level Administrative User Sessions

The system comes configured with a context called *local* that you use specifically for management purposes. The context selection process for context-level administrative users (those configured within a context) is simplified because the management ports on the MIO are associated only with the Local context. Therefore, the source and destination contexts for a context-level administrative user responsible for managing the entire system should always be the local context.

A context-level administrative user can be created in a non-local context. These management accounts have privileges only in the context in which they are created. This type of management account can connect directly to a port in the context in which they belong, if local connectivity is enabled (SSHD, for example) in that context.

For all FTP or SFTP connections, you must connect through an MIO management interface. If you SFTP or FTP as a non-local context account, you must use the username syntax of *username@contextname*.



Important

In release 20.0 and higher Trusted StarOS builds, FTP is not supported.

The context selection process becomes more involved if you are configuring the system to provide local authentication or work with a AAA server to authenticate the context-level administrative user.

The system gives you the flexibility to configure context-level administrative users locally (meaning that their profile will be configured and stored in its own memory), or remotely on an AAA server. If a locally-configured user attempts to log onto the system, the system performs the authentication. If you have configured the user profile on an AAA server, the system must determine how to contact the AAA server to perform authentication. It does this by determining the AAA context for the session.

The following table and flowchart describe the process that the system uses to select an AAA context for a context-level administrative user. Items in the table correspond to the circled numbers in the flowchart.

Figure 2: Context-level Administrative User AAA Context

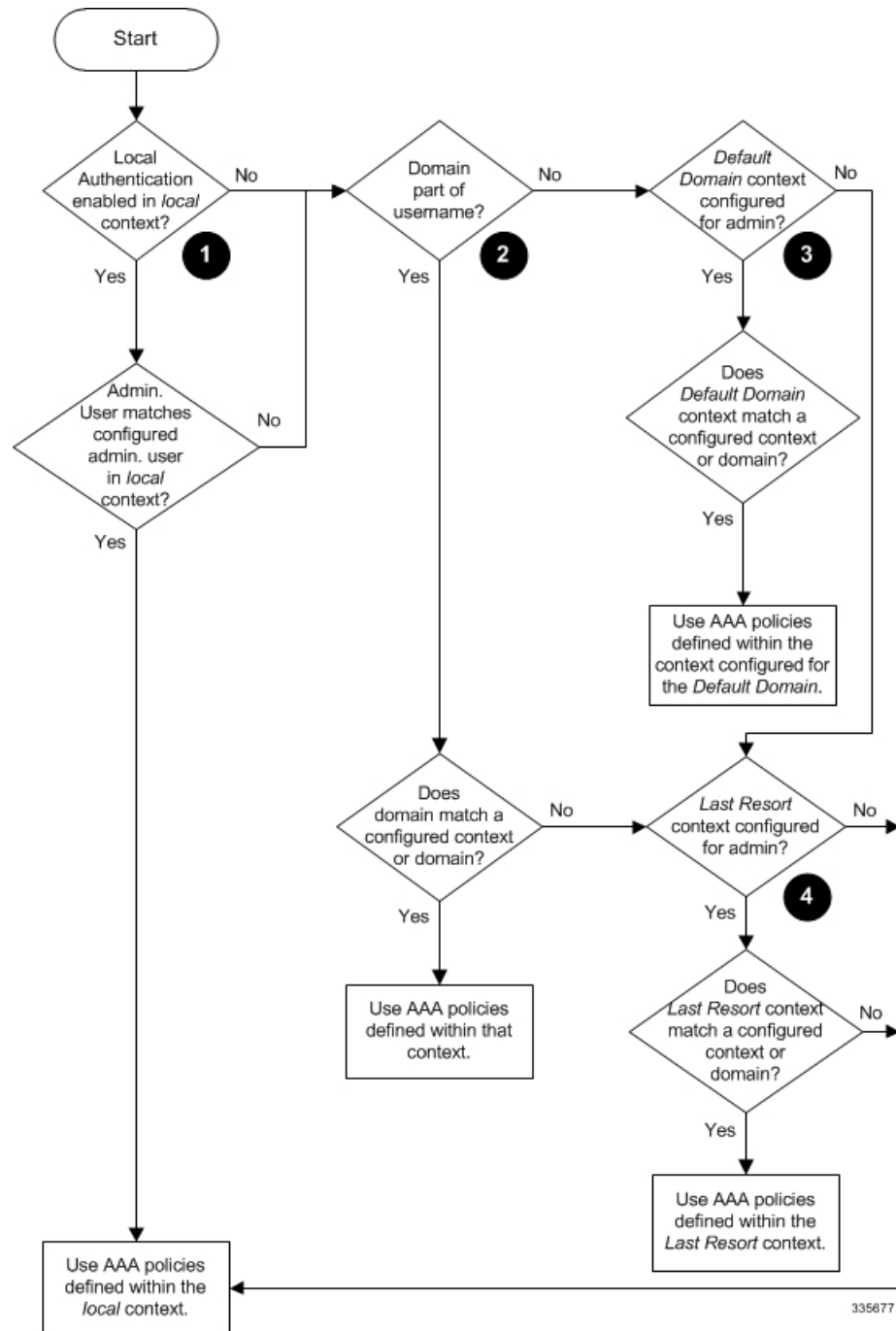


Table 1: Context-level Administrative User AAA Context Selection

Item	Description
1	<p>During authentication, the system determines whether local authentication is enabled in the <i>local</i> context.</p> <p>If it is, the system attempts to authenticate the administrative user in the <i>local</i> context. If it is not, proceed to item 2 in this table.</p> <p>If the administrative user's username is configured, authentication is performed by using the AAA configuration within the <i>local</i> context. If not, proceed to item 2 in this table.</p>
2	<p>If local authentication is disabled on the system or if the administrative user's username is not configured in the <i>local</i> context, the system determines if a domain was received as part of the username.</p> <p>If there is a domain and it matches the name of a configured context or domain, the systems uses the AAA configuration within that context.</p> <p>If there is a domain and it does not match the name of a configured context or domain, Go to item 4 in this table.</p> <p>If there is no domain as part of the username, go to item 3 in this table.</p>
3	<p>If there was no domain specified in the username or the domain is not recognized, the system determines whether an <i>AAA Administrator Default Domain</i> is configured.</p> <p>If the default domain is configured and it matches a configured context, the AAA configuration within the <i>AAA Administrator Default Domain</i> context is used.</p> <p>If the default domain is not configured or does not match a configured context or domain, go to item 4 item below.</p>
4	<p>If a domain was specified as part of the username but it did not match a configured context, or if a domain was not specified as part of the username, the system determines if the <i>AAA Administrator Last Resort context parameter</i> is configured.</p> <p>If a last resort, context is configured and it matches a configured context, the AAA configuration within that context is used.</p> <p>If a last resort context is not configured or does not match a configured context or domain, the AAA configuration within the <i>local</i> context is used.</p>

In Release 21.4 and higher (Trusted builds only):

- Users can only access the system through their respective context interface.

- If the user attempts to log in to their respective context through a different context interface, that user will be rejected.
- Irrespective of whether the users are configured in any context with 'authorized-keys' or 'allowusers', with this feature these users will be rejected if they attempt to log in via any other context interface other than their own context interface.
- Users configured in any non-local context are required to specify which context they are trying to log in to. For example:

```
ssh username@ctx_name@ctx_ip_addr
```

Context Selection for Subscriber Sessions

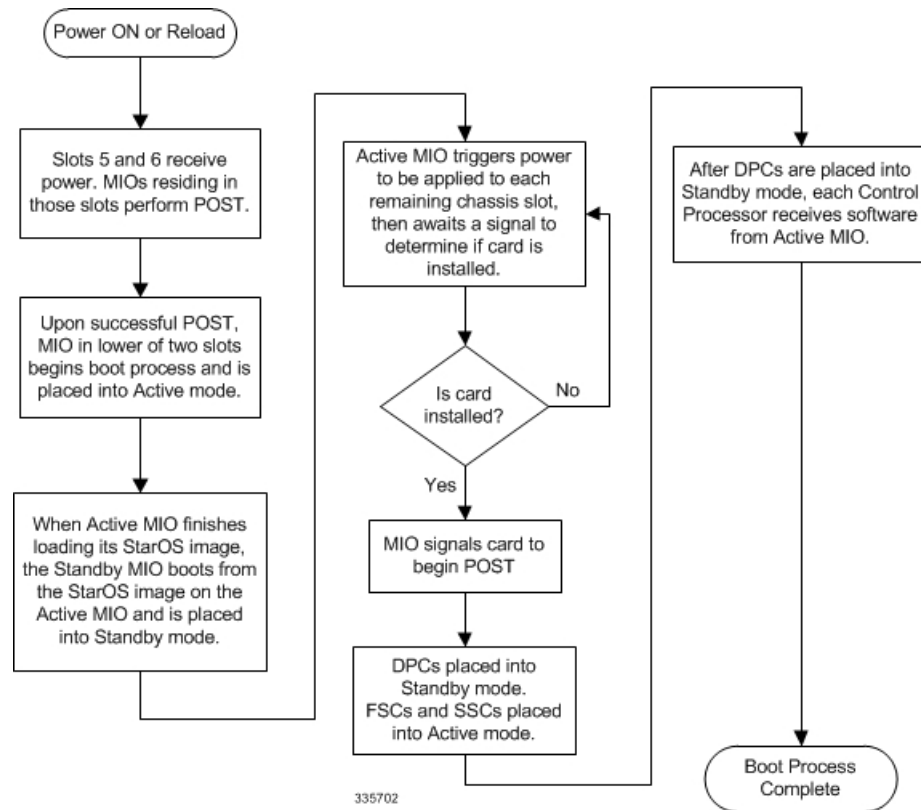
The context selection process for a subscriber session is more involved than that for the administrative users. Subscriber session context selection information for specific products is located in the *Administration Guide* for the individual product.

Understanding the ASR 5500 Boot Process

Part of the configuration process requires that you allocate hardware resources for processing and redundancy. Therefore, before you configure the system, it is important to understand the boot process which determines how the hardware components are brought on line.

The following flowchart shows each step in the startup process. For additional information about system configuration files, refer to the *Understanding Configuration Files* section.

Figure 3: ASR 5500 Process Flowchart



The following steps describe the system's boot process:

-
- Step 1** When power is first applied to the chassis, or after a reboot, only the MIO/UMIO/MIO2s in slot 5 and slot 6 receive power.
- Step 2** During the startup process, the MIO/UMIO/MIO2 performs a series of power-on self tests (POSTs) to ensure that its hardware is operational.
- Step 3** If the MIO/UMIO/MIO2 in slot 5 successfully executes all POSTs, it becomes the active MIO. The MIO in slot 6 becomes the standby card. If there is a problem with the MIO in slot 5, the MIO in slot 6 becomes the active MIO.
- Step 4** The active MIO/UMIO/MIO2 begins loading the operating system software image designated in the boot stack. The boot stack entries are contained in the boot.sys file that resides on flash memory on the MIO/UMIO. The standby MIO/UMIO/MIO2 observes the active card startup. If the file on the active MIO/UMIO/MIO2 is loads normally, the standby MIO/UMIO boots from the active card image. If the active MIO/UMIO experiences problems during this phase, the standby MIO/UMIO/MIO2 loads its software image designated by its own boot stack entry in its boot.sys file and takes over control of the system as the active MIO/UMIO/MIO2.
- Step 5** After the software image is loaded into its memory, the active MIO/UMIO/MIO2 determines whether other cards are installed in the chassis by applying power to the other chassis slots and signalling them. If the chassis slot contains a card, power is left On to that slot. All empty slots are powered off.
- If no MIOs are installed or if both fail to boot successfully, no other card installed in the system will boot.
- Step 6** When power is applied to the DPC/UDPCs or DPC2/UDPC2s installed in the system, they each perform their own series of POSTs.

- Step 7** After successful POST, each DPC/UDPC or DPC2/UDPC2 enters standby mode.
- Step 8** After entering the standby mode, each of the control processors (CPs) on the DPC/UDPCs or DPC2/UDPC2s communicate with the active MIO/UMIO/MIO2 to receive the appropriate code.
- Step 9** Upon successful loading of the software image, the system loads a configuration file designated in the boot stack (boot.sys file). If this is the first time the system is powered on and there is no configuration file, the active MIO/UMIO/MIO2 invokes the system's Quick Setup wizard. Use the Quick Setup wizard to configure basic system parameters for communication across the management network.

The wizard creates a configuration file (system.cfg) that you can use as a starting point for subsequent configurations. This allows you to configure the system automatically by applying the configuration file during any subsequent boot. For additional information about system configuration files, refer to the *Understanding Configuration Files* section.

Understanding Configuration Files

The system supports the use of a file or script to modify configurable parameters. Using a file for offline system configuration reduces the time it takes to configure parameters on multiple systems.

A system configuration file is an ASCII text file that contains commands and configuration parameters. When you apply the configuration file, the system parses through the file line-by-line, testing the syntax and executing the command. If the syntax is incorrect, a message is displayed to the CLI and the system proceeds to the next command. Lines that begin with # are considered remarks and are ignored.



Important Pipes (|), used with the **grep** and **more** keywords, can potentially cause errors in configuration file processing. Therefore, the system automatically ignores keywords with pipes during processing.



Important Always save configuration files in UNIX format. Failure to do so can result in errors that prevent configuration file processing.

The commands and configuration data within the file are organized and formatted just as they would be if they were being entered at the CLI prompt. For example, if you wanted to create a context called *source* in the CLI, you would enter the following commands at their respective prompts:

```
[local]host_name# config
[local]host_name(config)# context source
[source]host_name(config-ctx)# end
```

To create a context called *source* using a configuration file, you would use a text editor to create a new file that consists of the following:

```
config
    context source
end
```

There are several important things to consider when using configuration files:

- The system automatically applies a configuration file at the end of the boot process. After the system boots up for the first time, a configuration file that you have created and that is tailored to your network

needs, can be applied. To make the system use your configuration file, modify the system's boot parameters according to the instructions located in *Software Management Operations*.

- In addition to being applied during the boot process, you can also apply configuration files manually at any time by executing the appropriate commands at the CLI prompt. Refer to the instructions in *Software Management Operations*.



Important When you apply a configuration file after the boot process, the file does not delete the configuration loaded as part of the boot process. Only those commands that are duplicated are overwritten.

- Configuration files can be stored in any of the following locations:
 - **USB Memory Stick:** Supported via a USB port on the active MIO (/usb1).
 - **Network Server:** Any workstation or server on the network that the system can access using the Secure File Transfer Protocol (SFTP). This is recommended for large network deployments in which multiple systems require the same configuration.
 - **/flash:** a solid-state device with limited storage.
 - **/hd-raid:** internal RAID storage.
- Each time you save configuration changes you made during a CLI session, you can save those settings to a file which you can use as a configuration file.

IP Address Notation

When configuring a port interface via the CLI you must enter an IP address. The CLI always accepts an IPv4 address, and in some cases accepts an IPv6 address as an alternative.

For some configuration commands, the CLI also accepts CIDR notation. Always view the online Help for the CLI command to verify acceptable forms of IP address notation.

IPv4 Dotted-Decimal Notation

An Internet Protocol Version 4 (IPv4) address consists of 32 bits divided into four octets. These four octets are written in decimal numbers, ranging from 0 to 255, and are concatenated as a character string with full stop delimiters (dots) between each number.

For example, the address of the loopback interface, usually assigned the host name localhost, is 127.0.0.1. It consists of the four binary octets 01111111, 00000000, 00000000, and 00000001, forming the full 32-bit address.

IPv4 allows 32 bits for an Internet Protocol address and can, therefore, support 2^{32} (4,294,967,296) addresses.

IPv6 Colon-Separated-Hexadecimal Notation

An Internet Protocol Version 6 (IPv6) address has two logical parts: a 64-bit network prefix, and a 64-bit host address part. An IPv6 address is represented by eight groups of 16-bit hexadecimal values separated by colons (:).

A typical example of a full IPv6 address is 2001:0db8:85a3:0000:0000:8a2e:0370:7334

The hexadecimal digits are case-insensitive.

The 128-bit IPv6 address can be abbreviated with the following rules:

- Leading zeroes within a 16-bit value may be omitted. For example, the address fe80:0000:0000:0202:b3ff:fe1e:8329 may be written as fe80:0:0:202:b3ff:fe1e:8329
- One group of consecutive zeroes within an address may be replaced by a double colon. For example, fe80:0:0:202:b3ff:fe1e:8329 becomes fe80::202:b3ff:fe1e:8329

IPv6 allows 128 bits for an Internet Protocol address and can support 2^{128} (340,282,366,920,938,000,000,000,000,000,000,000,000) internet addresses.

CIDR Notation

Classless Inter-Domain Routing (CIDR) notation is a compact specification of an Internet Protocol address and its associated routing prefix. It is used for both IPv4 and IPv6 addressing in networking architectures.

CIDR is a bitwise, prefix-based standard for the interpretation of IP addresses. It facilitates routing by allowing blocks of addresses to be grouped into single routing table entries. These groups (CIDR blocks) share an initial sequence of bits in the binary representation of their IP addresses.

CIDR notation is constructed from the IP address and the prefix size, the latter being the number of leading 1 bits of the routing prefix. The IP address is expressed according to the standards of IPv4 or IPv6. It is followed by a separator character, the slash (/) character, and the prefix size expressed as a decimal number.

The address may denote a single, distinct, interface address or the beginning address of an entire network. In the latter case the CIDR notation specifies the address block allocation of the network. The maximum size of the network is given by the number of addresses that are possible with the remaining, least-significant bits below the prefix. This is often called the host identifier.

For example:

- the address specification 192.168.100.1/24 represents the given IPv4 address and its associated routing prefix 192.168.100.0, or equivalently, its subnet mask 255.255.255.0.
- the IPv4 block 192.168.0.0/22 represents the 1024 IPv4 addresses from 192.168.0.0 to 192.168.3.255.
- the IPv6 block 2001:DB8::/48 represents the IPv6 addresses from 2001:DB8:0:0:0:0:0:0 to 2001:DB8:0:FFFF:FFFF:FFFF:FFFF:FFFF.
- ::1/128 represents the IPv6 loopback address. Its prefix size is 128, the size of the address itself, indicating that this facility consists of only this one address.

The number of addresses of a subnet defined by the mask or prefix can be calculated as $2^{\text{address size} - \text{mask}}$, in which the address size for IPv4 is 32 and for IPv6 is 128. For example, in IPv4, a mask of /29 gives $2^{32-29} = 2^3 = 8$ addresses.

Alphanumeric Strings

Some CLI commands require the entry of an alphanumeric string to define a value. The string is a contiguous collection of alphanumeric characters with a defined minimum and maximum length (number of characters).

Character Set

The alphanumeric character set is a combination of alphabetic (Latin letters) and/or numeric (Arabic digits) characters. The set consists of the numbers 0 to 9, letters A to Z (uppercase) and a to z (lowercase). The underscore character (`_`) and dash/hyphen (`-`) are also considered to be members of the alphanumeric set of characters.

Blank spaces (whitespaces or `SPACE` characters) should mostly be avoided in alphanumeric strings, except in certain ruledef formats, such as time/date stamps.

Do not use any of the following "special" characters in an alphanumeric string except as noted below:

- `&` (ampersand)
- `'` (apostrophe)
- `<` `>` (arrow brackets) [see exception below]
- `*` (asterisk) [see wildcard exception below]
- `{` `}` (braces)
- `[` `]` (brackets)
- `$` (dollar sign) [see wildcard exception below]
- `!` (exclamation point) [see exception below]
- `(` `)` [parentheses]
- `%` (percent) [see exception below]
- `#` (pound sign) [see exception below]
- `?` (question mark)
- `'` (quotation mark – single)
- `"` (quotation mark – double)
- `;` (semicolon)
- `\` (slash – backward) [see exception below]
- `/` (slash – forward) [see exception below]
- `~` (tilde)
- `|` (vertical bar) [see exception below]

The following characters may appear in strings entered in ruledefs, APNs, license keys and other configuration/display parameters:

- <> (arrow brackets) [less than or greater than]
- * (asterisk) [wildcard]
- : (colon)
- \$ (dollar sign) [wildcard]
- . (dot)
- = (equals sign)
- ! (exclamation point)
- % (percent)
- / (slash – forward)
- | (vertical bar)

The following characters may be used to delimit the domain from the user name for global AAA functions:

- @ (at sign)
- - (dash or hyphen)
- # (hash or pound sign)
- % [percent]
- \ (slash – backward) [must be entered as double slash "\\"]
- / (slash – forward)

Quoted Strings

If descriptive text requires the use of spaces between words, the string must be entered within double quotation marks (" "). For example:

```
interface "Rack 3 Chassis 1 port 5/2"
```



CHAPTER 2

Getting Started

- [ASR 5500 Configuration, on page 17](#)
- [Using the ASR 5500 Quick Setup Wizard, on page 17](#)
- [Using the CLI for Initial Configuration, on page 25](#)
- [Configuring System Administrative Users, on page 27](#)
- [Configuring the System for Remote Access, on page 28](#)
- [Configuring SSH Options, on page 30](#)
- [Configuring the Management Interface with a Second IP Address, on page 42](#)

ASR 5500 Configuration

Following the successful installation of the system hardware, you must configure a set of software parameters and then save these settings in a system configuration file that is launched whenever the system is reloaded.

The first time power is applied to the system, the active Management Input/Output (MIO/UMIO//MIO2) card (typically the one installed in chassis slot 5) automatically launches a Quick Setup Wizard on its console port. This wizard guides you through the initial configuration of the system.

The serial console port (logical port 3) is located on the front panel of the MIO card.

You can choose not to use the wizard and perform the initial configuration by issuing commands via the command line interface (CLI). You can manually launch the wizard by running the **setup** command in the Exec mode. Refer to the *Command Line Interface Reference* for details.

Using the ASR 5500 Quick Setup Wizard

The Quick Setup Wizard consists of three parts:

- Configuring a context-level security administrator and hostname
- Configuring the Ethernet interface for out-of-band (OOB) management
- Configuring the system for remote CLI access

The Quick Setup Wizard

The Quick Setup Wizard consists of a series of questions that prompt you for input before proceeding to the next question. Some prompts may be skipped depending on previous responses or whether a particular function is supported in the StarOS release.

The following is a sample of the Quick Setup Wizard with responses that are designed to show most of the questions.

```
[local]<host_name># setup
1. Do you wish to continue with the Quick Setup Wizard[yes/no]: yes
2. Enable basic configuration[yes/no]: yes
3. Change chassis key value - WARNING: old configuration scripts will become
invalid after key change[yes/no]: no
5. Create new tech-support password[yes/no]: yes
6. New tech-support password: <ts_password>
7. local context administrator username[admin]: <admin_name>
8. local context administrator password: <admin_password>
9. confirm local context administrator password: <admin_password>
10. hostname[<host_name>]: <host_name>
11. Create single dedicated LI context[yes/no]: no
13. Enable segregated LI configuration[yes/no]: yes
14. Enable LOCAL interface[yes/no]: yes
17. LOCAL Out of band Ip Address: <ip_address>
18. LOCAL Out of band subnet mask: <subnet_mask>
19. Default gateway Ip Address: <gw_ip_address>
20. Enable remote access[yes/no]: yes
21. Enable sshd[yes/no]: yes
22. Enter a default SSH key size[2048/3072/4096/5120/7168/9216]: 2048
23. Enable sftp server[yes/no]: yes
24. Enable telnetd[yes/no]: no
25. Enable ftpd[yes/no]: no
Do you want to review your selections[no/yes]: no
Do you want to view the configuration script created[yes/no]: yes
<configuration_script_output>
Do you want to apply configuration script created[yes/no]: no
[local]<host_name>#
```

Table 2: Quick Setup Wizard Questions

Ques.	Task	Description/Notes
1	Enter or exit the wizard.	Enter no at the prompt to automatically be directed to the command line interface (CLI). Proceed to Using the CLI for Initial Configuration, on page 25 for instructions on performing an initial system configuration with the CLI. Enter setup at the command prompt to re-invoke the wizard.
2	Enable a basic configuration.	Enter yes to create a basic configuration file.

Ques.	Task	Description/Notes
3	Change chassis key value.	<p>A unique chassis key is configured at the factory for each system. This key is used to decrypt encrypted passwords found in generated configuration files. The system administrator can create a unique chassis key that will be used to encrypt passwords stored in configuration files.</p> <p>Enter yes to set a new chassis key. Refer to the instructions in <i>System Settings</i>. Additional information can be found in the <i>System Security</i> chapter.</p>
5, 6	Create a tech-support password.	See <i>Enabling Password for Access to CLI-test commands</i> in the <i>System Security</i> chapter for additional information.
7	Configure an administrative username for the system.	<p>The name of the default administrative user configured through the wizard is <i>admin</i>.</p> <p>Administrative username is an alphanumeric string of 1 through 32 characters that is case sensitive.</p>
8, 9	Configure an administrative password for the system.	Administrative user password is an alphanumeric string of 1 through 63 characters that is case sensitive. For release 21.0 and later, you can enter 127 characters for the password.
10	Change the hostname for the system.	The hostname appears in the StarOS CLI prompt.
11	Create a single Dedicated-LI context.	Before creating a Dedicated LI context, refer to the <i>Lawful Intercept Configuration Guide</i> . Once created, a Dedicated LI context cannot be undone.
13	Enable segregated LI Configuration.	Before segregating system and LI configurations, refer to the <i>Lawful Intercept Configuration Guide</i> .

Ques.	Task	Description/Notes
14, 17, 18	Configure a single Management Input/Output (MIO/UMIO/MIO2) out-of-band management interface for out-of-band system management.	<p>Traffic on the management LAN is not transferred over the same media as user data and control signaling.</p> <p>For security reasons, it is recommended that management functions be maintained on a separate network from user data and control signaling.</p> <p>MIO port 1 (mio1) is the 1000Base-T default management port.</p> <p>MIO port 2 (mio2) is available as a secondary management port.</p> <p>Use the RJ-45 interfaces to connect the system to the management network with CAT5 Ethernet cable.</p> <p>Configure an IP address and subnet mask for the interface.</p>
19	Configure a default gateway for the interface.	Enter an IP address.
20	Enable remote access.	<p>Enter yes to allow remote access to this system.</p> <p>Instructions for configuring the second management interface on the MIO can be found in the <i>System Settings</i> chapter.</p>

Ques.	Task	Description/Notes
21–23	Enable SSH remote access protocols for accessing the system.	<p>Secure Shell (SSH) uses TCP port number 22 by default, if enabled.</p> <p>In Release 19.0 and prior releases, SSH V1 and/or V2 are supported. If SSH is enabled, you can also enable SSH File Transfer Protocol (SFTP) server functionality.</p> <p>In Release 19.2 and higher, you can specify the SSH key size. The SSH v2-RSA key generation uses that key size value.</p> <p>Note: For maximum security, use only SSH v2.</p> <p>In Release 19.2 and higher, only SSH v2 is supported.</p> <p>Secure File Transfer Protocol (SFTP) uses TCP port number 22 by default, if enabled [subsystem sftp].</p>
24	Enable remote access via telnet.	<p>Note: For maximum system security, do <u>not</u> enable telnet protocol.</p> <p>Note: In release 20.0 and higher <u>Trusted</u> StarOS builds, telnet is not supported.</p>
25	Enable FTP access to the system.	<p>File Transfer Protocol (FTP) uses TCP port number 21 by default, if enabled.</p> <p>Note: For maximum system security, do <u>not</u> enable FTP.</p> <p>Note: in release 20.0 and higher <u>Trusted</u> StarOS builds, FTP is not supported.</p>
—	Review and/or modify the configuration of previous prompts.	<ol style="list-style-type: none"> 1. Enter the number of the prompt to be modified. 2. Configure the parameter. 3. <i>Optional.</i> Repeat <i>step 1</i> and <i>step 2</i> to modify additional settings. 4. Enter "done" when you have completed all changes.

Ques.	Task	Description/Notes
—	Review the configure script created by the wizard based on your inputs.	An example of a created script is displayed in the example below. Variables are displayed in italics (<i>variable</i>).
—	Apply the configuration file to the system.	Once applied, the parameter configuration is automatically saved to the system.cfg file stored in MIO/UMIO/MIO2 flash memory.

```

Do you want to view the configuration script created[yes/no]: y
config
  system hostname hostname
  context local
    administrator admin_name password passwd
    interface miol
      ip address ip_address subnet
      #exit
    ip route 0.0.0.0 0.0.0.0 gw_address miol
    ssh key v1_key
    ssh key v2_rsa_key
    ssh key v2_dsa_key
    server sshd
    subsystem sftp
    #exit
  no server telnetd
  no server ftpd
  #exit
  port ethernet 5/1
  bind interface miol local
  no shutdown
  #exit
end
Do you want to apply configuration script created[yes/no]:

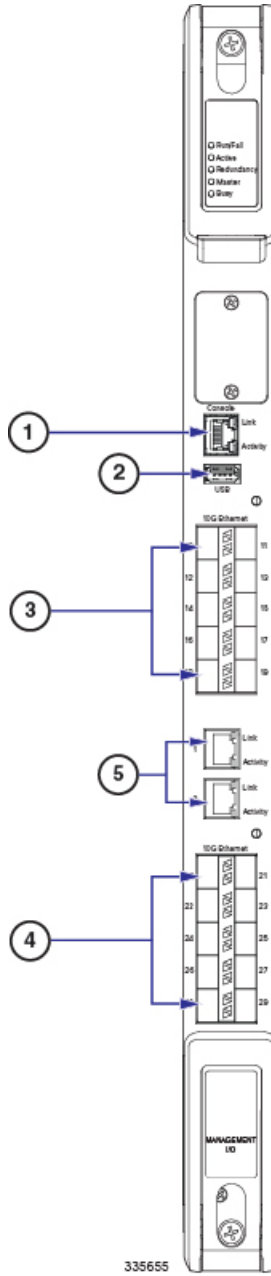
```



Important

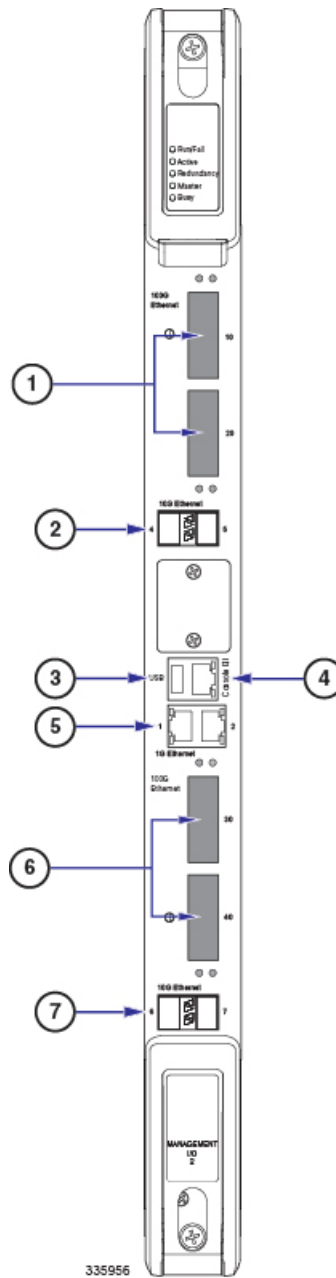
Once configuration using the wizard is complete, proceed to instructions on how to configure other system parameters.

Figure 4: MIO Interfaces



1	Console port [Port 3]	2	USB port
3	10 GbE ports, DC-1 [Ports 10 – 19]	4	10 GbE ports, DC-2 [Ports 20 – 29]
5	1 GbE ports (1000Base-T) [Ports 1 and 2]		

Figure 5: MIO2 Interfaces



1	100 GbE ports, DC-1 [Ports 10 and 11]	2	10GbE ports, DC-1 [Ports 12 and 13]
3	USB port	4	Console port [Port 3]
5	1 GbE ports (1000Base-T) [Ports 1 and 2]		
6	100 GbE ports, DC-2 [Ports 20 and 21]	7	10GbE ports, DC-2 [Ports 22 and 23]

Using the CLI for Initial Configuration

The initial configuration consists of the following:

- Configuring a context-level security administrator and hostname
- Configuring the Ethernet interface on the MIO/UMIO/MIO2 card
- Configuring the system for remote CLI access via Telnet, SSH, or FTP (secured or unsecured)



Important In release 20.0 and higher Trusted StarOS builds, FTP and telnet are not supported.

This section provides instructions for performing these tasks using the CLI.

Step 1 At the CLI prompt, enter:

```
[local]host_name# configure
[local]host_name(config)#
```

Step 2 Enter the context configuration mode by entering the following command:

```
[local]host_name(config)# context local
[local]host_name(config-ctx)#
```

The *local* context is the system's management context. Contexts allow you to logically group services or interfaces. A single context can consist of multiple services and can be bound to multiple interfaces.

Step 3 Enter the following command to configure a context-level security administrator for the system:

```
administrator user_name [ encrypted ] password password | [ ecs ] [ expiry-date date_time
] [ ftp ] [ li-administration ] [ nocli ] [ noecs ] [ timeout-absolute
timeout_absolute [ timeout-min-absolute timeout_min_absolute ] [ timeout-idle timeout_idle
] [ timeout-min-idle timeout_min_idle
```

You must configure a context-level security administrator during the initial configuration. After you complete the initial configuration process and end the CLI session, if you have not configured a security administrator, CLI access will be locked. For complete information about the commands in this section, see the *Context Configuration Mode Commands* chapter of the *Command Line Interface Reference*.

Note For security reasons, **li-administration** accounts must be restricted for use only with Lawful Intercept (LI) functionality and not for general system administration. Only security administrators and administrators can provision LI privileges. To ensure security in accordance with Law Enforcement Agency (LEA) standards, LI administrative users must access the system using the Secure Shell (SSH) protocol only. LI privileges can be optionally configured for use within a single context system-wide. For additional information, see the *Lawful Intercept Configuration Guide*.

Step 4 Enter the following command at the prompt to exit the context configuration mode:

```
[local]host_name(config-ctx)# exit
[local]host_name(config)#
```

Step 5 Enter the following command to configure a hostname by which the system will be recognized on the network:

```
[local]host_name(config)# system hostname host_name
```

host_name is the name by which the system will be recognized on the network. The hostname is an alphanumeric string of 1 through 63 characters that is case sensitive.

Step 6 Configure the network interfaces on the MIO/UMIO/MIO2 using the following instructions:

a) Enter the context configuration mode by entering the following commands:

```
[local]host_name(config)# context local
[local]host_name(config-ctx)#
```

b) Enter the following command to specify a name for the interface:

```
[local]host_name(config-ctx)# interface interface_name
```

interface_name is the name of the interface expressed as an alphanumeric string of 1 through 79 characters that is case sensitive. The following prompt appears as the system enters the Ethernet Interface Configuration mode:

```
[local]host_name(config-if-eth)#
```

c) Configure an IP address for the interface configured in the previous step by entering the following command:

```
{ ip address | ipv6 address } ipaddress subnetmask
```

If you are executing this command to correct an address or subnet that was mis-configured with the Quick Setup Wizard, you must verify the default route and port binding configuration. Use *step 11* and *step 6* of this procedure. If there are issues, perform steps *7e* through *7k* to reconfigure the information.

d) Enter the following command to exit the Ethernet interface configuration mode:

```
[local]host_name(config-if-eth)# exit
[local]host_name(config-ctx)#
```

e) Configure a static route, if required, to point the system to a default gateway. Entering the following command:

```
{ ip | ipv6 } route gw_address interface_name
```

f) Enter the following to exit from the context configuration mode:

```
[local]host_name(config-ctx)# exit
[local]host_name(config)#
```

g) Enter the Ethernet Port Configuration mode:

```
port ethernet slot#/port#
```

h) Bind the port to the interface that you created in step 7b. Binding associates the port and all of its settings to the interface. Enter the following command:

```
[local]host_name(config-port-<slot#/port#>)# bind interface interface_name local
[local]host_name(config-port-<slot#/port#>)# no shutdown
```

interface_name is the name of the interface that you configured in *step 7b*.

i) Exit the Ethernet Interface Configuration mode by entering the command:

```
[local]host_name(config-port-<slot#/port#>)# exit
[local]host_name(config)#
```

Important Refer below for instructions on configuring the MIO/UMIO/MIO2 management interface with a second IP address.

Configuring System Administrative Users

This section describes some of the security features that allow security administrators to control user accounts.

Limiting the Number of Concurrent CLI Sessions

Security administrators can limit the number of concurrent interactive CLI sessions. Limiting the number of concurrent interactive sessions reduces the consumption of system-wide resources. It also prevents a user from potentially accessing sensitive user information which is already in use.

Most privileged accounts do not require multiple concurrent logins.



Important

Configuring the maximum number of sessions is recommended for all privileged accounts.

Security administrators can limit the number of concurrent interactive CLI sessions with three different ways depending on the authentication method which is used for that particular user account.

StarOS supports three login authentication methods:

- TACACS+ Server users
- Local-User users
- AAA Context users

For additional information on configuring the maximum number of sessions for TACACS+ Server users, see [Operation](#). For additional information on configuring the maximum number of sessions for Local-User users and AAA context users, see [Configuring Context-level Administrative Users](#).

Each authentication method must be configured separately because each of the three authentication methods can use the same user name.

Automatic Logout of CLI Sessions

Security administrators can configure an automatic logout of certain user accounts. Limiting the number of minutes that an interactive CLI session can be in use reduces the consumption of system-wide resources. It also prevents a user from potentially accessing a user account in a terminal window which is left idle. All authentication methods described in this section support both the idle session timeout technique and the absolute session timeout technique.

Most privileged accounts do not require an indefinite login timeout limit.



Important

Configuring the session timeout is strongly recommended for all privileged accounts.

The idle timeout and session timeout fields in the **show tacacs summary** and **show tacacs session id** commands allow administrators to configure an automatic logout of certain accounts.

Session Timeout: allows a security administrator to specify the maximum amount of minutes that a user can be logged in to a session before the session is automatically disconnected.

Idle Timeout: allows a security administrator to specify the maximum amount of minutes that a session can remain in an idle state before the session is automatically disconnected.



Important

The session timeout and idle timeout fields are not exclusive. If both are specified, then the idle timeout should always be lower than the session timeout since a lower session timeout will always be reached first.

For additional information on configuring the maximum number of minutes that an interactive CLI session can be in use, see the **idle-sessions threshold** command and the **clear tacacs sessions** CLI command in the *CLI Reference* and the **show tacacs summary** and **show tacacs session id** in the *Statistics and Counter Reference*.

Configuring the System for Remote Access

Configure the system for remote access. An administrative user may access the system from a remote location over a local area network (LAN) or wide area network (WAN):

- Telnet
- Secure Shell (SSH)
- File Transfer Protocol (FTP) (secured or unsecured)
- Trivial File Transfer Protocol (TFTP)



Important

If there are two simultaneous telnet sessions, and one administrator deletes the context into which the other administrator is logged, the administrator in the deleted context will not be automatically kicked into the *local* context. Although the deleted context will still appear in the CLI prompt, context specific commands will generate errors.



Important

For maximum security, use SSH v2.



Important

In release 20.0 and higher Trusted StarOS builds, FTP and telnet are not supported.

Step 1

Enter the context configuration mode by entering the following command:

```
[local]host_name(config)# context local
[local]host_name(config-ctx)#
```


Step 2 If desired, configure the system to allow Telnet access:

```
[local]host_name(config-ctx)# server telnetd
```

For maximum system security, you should not enable telnet.

Step 3 Configure the system to allow SSH access:

```
[local]host_name(config-ctx)# ssh generate key [ type { v1-rsa | v2-rsa | v2-dsa } ]
```

v2-rsa is the recommended key type.

In StarOS 19.2 and higher, the **v1-rsa** keyword has been removed from and the **v2-dsa** keyword has been concealed within the Context Configuration mode **ssh generate** CLI command. A keyword that was supported in a previous release may be concealed in subsequent releases. StarOS continues to parse concealed keywords in existing scripts and configuration files created in a previous release. But the concealed keyword no longer appears in the command syntax for use in new scripts or configuration files. Entering a question mark (?) will not display a concealed keyword as part of the Help text. A removed keyword generates an error message when parsed.

```
[local]host_name(config-ctx)# ssh generate key type v2-rsa
```

Step 4 Configure the system to support SFTP:

```
[local]host_name(config-ctx)# server sshd
```

```
[local]host_name(config-sshd)# subsystem sftp
```

```
[local]host_name(config-sshd)# exit
```

For additional information about SSH, see [Configuring SSH Options, on page 30](#)

Step 5 Configure the system to allow FTP access, if desired, by entering the following command:

```
[local]host_name(config-ctx)# server ftpd
```

For maximum system security, you should not enable FTP. In release 20.0 and higher Trusted StarOS builds, FTP is not supported

Step 6 Exit the configuration mode by entering the following command:

```
[local]host_name(config-ctx)# end
```

```
[local]host_name#
```

Step 7 Verify the configuration by entering the following command:

```
[local]host_name# show configuration
```

The CLI output should be similar to the sample output:

```
context local
  interface interface_name
    ip address ipaddress subnetmask
    exit
  subscriber default
    exit
  administrator admin_name password admin_password
  no server telnetd
  no server ftpd
  ssh generate key
  server sshd
  subsystem sftp
  exit
port ethernet 5/1
  bind interface interface_name local
```

```

exit
port ethernet 5/1
no shutdown
exit
snmp engine-id local 800007e580ed826c191ded2d3d
end

```

Step 8 Verify the configuration of the IP routes by entering the following command:

```
[local]host_name# show ip route
```

The CLI output should be similar to the sample output:

```

"*" indicates the Best or Used route.
Destination          Nexthop          Protocol  Prec Cost Interface
*0.0.0.0/0           ipaddress        static    1    0    miol
*network             0.0.0.0          connected 0    0    miol

```

Step 9 Verify the interface binding by entering the following command:

```
[local]host_name# show ip interface name interface_name
```

interface_name> is the name of the interface that was configured in *step 7b*. The CLI output should be similar to the sample output:

```

Intf Name:           miol
Intf Type:           Broadcast
Description:
IP State:            UP (Bound to 5/1 untagged, ifIndex 83951617)
IP Address:          ipaddress      Subnet Mask:  subnetmask
Bcast Address:      bcastaddress  MTU:         1500
Resoln Type:        ARP             ARP timeout: 3600 secs
Number of Secondary Addresses: 0

```

Step 10 Save your configuration as described in *Verifying and Saving Your Configuration*.

Configuring SSH Options

SSHv2 RSA is the only version of SSH supported under StarOS. Keywords previously supported for SSHv1 RSA and SSHv2 DSA have been removed from or concealed within the StarOS CLI.



Important

A keyword that was supported in a previous release may be concealed in subsequent releases. StarOS continues to parse concealed keywords in existing scripts and configuration files created in a previous release. But the concealed keyword no longer appears in the command syntax for use in new scripts or configuration files. Entering a question mark (?) will not display a concealed keyword as part of the Help text. Removed keywords generate an error message when parsed.

Version 1 of the SSH protocol is now obsolete due to security vulnerabilities. The **v1-rsa** keyword has been removed for the Context Configuration mode **ssh** command. Running a script or configuration that uses the SSHv1-RSA key returns an error message and generates an event log. The output of the error message is shown below:

```

CLI print failure Failure: SSH V1 contains multiple structural vulnerabilities and is no
longer considered secure. Therefore we don't support v1-rsa SSH key any longer, please
generate a new v2-rsa key to replace this old one.

```

If the system boots from a configuration that contains the **v1-rsa** key, you can expect a boot failure when logging in through SSH. The workaround is to log in via the Console port, re-generate a new ssh v2-rsa key, and configure server sshd. It will then be possible to log in via ssh.

The **v2-dsa keyword** is now concealed for the Context Configuration mode **ssh** command

The **v1-rsa** keyword has been removed from the Exec mode **show ssh key** CLI command.

SSH Host Keys

SSH key-based authentication uses two keys, one "public" key that anyone is allowed to see, and another "private" key that only the owner is allowed to see. You create a key pair, securely store the private key on the device you want to log in from, and store the public key on the system (ASR 5500) that you wish to log into.

SSH host keys are generated within a specified StarOS context. The context is associated with a user interface.

You set or remove an administrative user name having authorized keys for access to the sshd server associated with context.

Setting SSH Key Size

The Global Configuration mode **ssh key-size** CLI command configures the key size for SSH key generation for all contexts (RSA host key only).

Step 1 Enter the Global Configuration mode.

```
[local]host_name# configure
[local]host_name(config)#
```

Step 2 Specify the bit size for SSH keys.

```
[local]host_name(config)# ssh key-size { 2048 | 3072 | 4096 | 5120 | 6144 | 7168 |
9216 }
```

The default bit size for SSH keys is 2048 bits.

Configuring SSH Key Generation Wait Time

SSH keys can only be generated after a configurable time interval has expired since the last key generation. The **ssh key-gen wait-time** command specifies this wait time in seconds. The default interval is 300 seconds (5 minutes).

Step 1 Enter the context configuration mode.

```
[local]host_name(config)# context context_name
[local]host_name(config-ctx)#
```

Step 2 Specify the wait time interval.

```
[local]host_name(config-ctx)# ssh key-gen wait-time seconds
[local]host_name(config-ctx)#
```

Notes:

- *seconds* is specified as an integer from 0 through 86400. Default = 300

Specifying SSH Encryption Ciphers

The SSH Configuration mode **ciphers** CLI command configures the cipher priority list in `sshd` for SSH symmetric encryption. It changes the cipher options for that context.

Step 1 Enter the SSH Configuration mode.

```
[local]host_name(config-ctx)# server sshd
```

Step 2 Specify the desired encryption algorithms.

```
[local]host_name(config-sshd)# ciphers algorithms
```

Notes:

- *algorithms* is a string of 1 through 511 alphanumeric characters that specifies the algorithm(s) to be used as a single string of comma-separated variables (no spaces) in priority order (left to right) from those shown below:
 - **blowfish-cbc** – symmetric-key block cipher, Cipher Block Chaining, (CBC)
 - **3des-cbc** – Triple Data Encryption Standard, CBC
 - **aes128-cbc** – Advanced Encryption Standard (AES), 128-bit key size, CBC
 - **aes128-ctr** – AES, 128-bit key size, Counter-mode encryption (CTR)
 - **aes192-ctr** – AES, 192-bit key size, CTR
 - **aes256-ctr** – AES, 256-bit key size, CTR
 - **aes128-gcm@openssh.com** – AES, 128-bit key size, Galois Counter Mode [GCM], OpenSSH
 - **aes256-gcm@openssh.com** – AES, 256-bit key size, GCM, OpenSSH
 - **chacha20-poly1305@openssh.com** – ChaCha20 symmetric cipher, Poly1305 cryptographic Message Authentication Code [MAC], OpenSSH

The default string for *algorithms* in a Normal build is:

```
blowfish-cbc,3des-cbc,aes128-cbc,aes128-ctr,aes192-ctr,aes256-ctr,aes128-gcm@openssh.com,aes256-gcm@openssh.com,
chacha20-poly1305@openssh.com
```

The default string for *algorithms* in a Trusted build is:

```
aes256-ctr,aes192-ctr,aes128-ctr
```

Step 3 Exit the SSH Configuration mode.

```
[local]host_name(config-sshd)# end
[local]host_name#
```

MAC Algorithm Configuration

Feature Summary and Revision History

Summary Data

Applicable Product(s) or Functional Area	All
Applicable Platform(s)	<ul style="list-style-type: none"> • ASR 5500 • VPC-DI • VPC-SI
Feature Default	Disabled - Configuration required
Related Changes in This Release	Not applicable
Related Documentation	<ul style="list-style-type: none"> • <i>ASR 5500 System Administration Guide</i> • <i>Command Line Interface Reference</i> • <i>VPC-DI System Administration Guide</i> • <i>VPC-SI System Administration Guide</i>

Revision History



Important

Revision history details are not provided for features introduced before releases 21.2 and N5.1.

Revision Details	Release
First introduced.	21.13

Feature Description

The MAC Algorithm Configuration feature allows to configure or change the priority of MAC algorithms of internal SSHD servers.

A new CLI **MACs** CLI command is introduced in SSH Configuration Mode in support of this feature.

Configuring MAC Algorithms

This section describes how to configure the MAC algorithms.

Use the following configuration to specify the priority of the MAC algorithms.

```

configure
  context context_name
    server sshd

```

```

macs algorithms
end

```

```

default macs

```

NOTES:

- *algorithms*: Refers to a string of 1 through 511 alphanumeric characters that specifies the algorithms to be used as a single string of comma-separated variables (no spaces) in priority order (left to right) from those listed as follows:
 - HMAC = hash-based message authentication code
 - SHA2 = Secure Hash Algorithm 2
 - SHA1 = Secure Hash Algorithm 1
 - ETM = Encrypt-Then-MAC
 - UMAC = message authentication code based on universal hashing

- The help string and list of algorithms in a Normal build are:

```

hmac-sha2-512-etm@openssh.com, hmac-sha2-256-etm@openssh.com, hmac-sha1-etm@openssh.com, hmac-sha2-512,
hmac-sha2-256, hmac-sha1, umac-128-etm@openssh.com, umac-128@openssh.com, umac-64-etm@openssh.com, umac-64@openssh.com

```

- The help string and list of algorithms in a Trusted build are:

```

hmac-sha2-512-etm@openssh.com, hmac-sha2-256-etm@openssh.com, hmac-sha1-etm@openssh.com, hmac-sha2-512,
hmac-sha2-256, hmac-sha1

```

- The default value string is:

```

hmac-sha2-512-etm@openssh.com, hmac-sha2-256-etm@openssh.com, hmac-sha1-etm@openssh.com, hmac-sha2-512,
hmac-sha2-256, hmac-sha1

```

Specifying MAC Algorithms

Use the following CLI commands to configure the priority of MAC algorithms. This command is configured in in SSH Configuration Mode.

```

configure
  context context_name
    server sshd
      macs algorithms
    end

```

```

default macs

```

NOTES:

- *algorithms*: Refers to a string of 1 through 511 alphanumeric characters that specifies the algorithms to be used as a single string of comma-separated variables (no spaces) in priority order (left to right) from those listed as follows:
 - HMAC = hash-based message authentication code
 - SHA2 = Secure Hash Algorithm 2
 - SHA1 = Secure Hash Algorithm 1
 - ETM = Encrypt-Then-MAC

- UMAC = message authentication code based on universal hashing
- The help string and list of algorithms in a Normal build are:

```
hmac-sha2-512-etm@openssh.com, hmac-sha2-256-etm@openssh.com, hmac-sha1-etm@openssh.com, hmac-sha2-512,
hmac-sha2-256, hmac-sha1, umac-128-etm@openssh.com, umac-128@openssh.com, umac-64-etm@openssh.com, umac-64@openssh.com
```
- The help string and list of algorithms in a Trusted build are:

```
hmac-sha2-512-etm@openssh.com, hmac-sha2-256-etm@openssh.com, hmac-sha1-etm@openssh.com, hmac-sha2-512,
hmac-sha2-256, hmac-sha1
```
- The default value string is:

```
hmac-sha2-512-etm@openssh.com, hmac-sha2-256-etm@openssh.com, hmac-sha1-etm@openssh.com, hmac-sha2-512,
hmac-sha2-256, hmac-sha1
```

Generating SSH Keys

The **ssh generate** command generates a public/private key pair which is to be used by the SSH server. The **v1-rsa** keyword has been removed from and the **v2-dsa** keyword concealed within the **ssh generate** CLI command. The only keyword available for generating SSH keys is **v2-rsa**.



Important The generated key pair remains in use until the command is issued again.

Step 1 Enter the context configuration mode:

```
[local]host_name(config)# context context_name
[local]host_name(config-ctx)#
```

Step 2 Generate an SSH key pair.

```
[local]host_name(config-ctx)# ssh generate key type v2-rsa
[local]host_name(config-ctx)#
```

Setting SSH Key Pair

The **ssh key** command sets the public/private key pair to be used by the system. The **v2-dsa** keyword is concealed in the **ssh key** command.

Specify the SSH key pair parameters.

```
[local]host_name(config-ctx)# ssh key data length octets type v2-rsa
```

Notes:

- **data** is the encrypted key expressed as an alphanumeric string of 1 through 1023 characters
- **length octets** is the length of the encrypted key in octets expressed as an integer from 0 through 65535
- **type** specifies the key type; **v2-rsa** is the only supported type.

Important For releases prior to 20.0, StarOS supports a maximum of 64 configurable authorized SSH keys. For release 20.0 and higher, StarOS supports a maximum of 200 configurable authorized SSH keys.

Authorized SSH User Access

You must authorize users to access a StarOS context from a specific host with an SSH authentication-key pair.

Authorizing SSH User Access

The SSH Configuration mode **authorized-key** command grants user access to a context from a specified host.

Step 1 Go to the SSH Configuration mode.

```
[local]host_name(config-ctx)# server sshd
[local]host_name(config-sshd)#
```

Step 2 Specify administrative user access via the **authorized-key** command.

```
[local]host_name(config-sshd)# authorized-key username user_name host host_ip [ type {  
v2-dsa | v2-rsa } ]
```

Notes:

- **username** *user_name* specifies an existing StarOS administrator user name as having authorized keys for access to the sshd server. The *user_name* is expressed as an alphanumeric string of 1 through 255 characters. User names should have been previously created via the Context Configuration mode **administrator** command using the **nopassword** option to prevent bypassing of the sshd keys. Refer to the *System Settings* chapter for additional information on creating administrators.
- **host** *host_ip* specifies the IP address of an SSH host having the authorization keys for this username. The IP address must be in IPv4 dotted-decimal or IPv6 colon-separated-hexadecimal notation.
- **type** specifies the key type; **v2-rsa** is the only supported type.

SSH User Login Restrictions

An administrator can restrict SSH access to the StarOS CLI to a "white list" of allowed users. Access to a service may be restricted to only those users having a legitimate need. Only explicitly allowed users will be able connect to a host via SSH. The user name may optionally include a specific source IP address.

The AllowUsers list consists of user name patterns, separated by space. If the pattern takes the form 'USER' then login is restricted for that user. If pattern is in the format 'USER@IP_ADDRESS' then USER and IP address are separately checked, restricting logins to those users from the specified IP address.

The default is to allow unrestricted access by any user.

Creating an Allowed Users List

The **allowusers add** command allows an administrator to create a list of users who may log into the StarOS CLI.

Step 1 Enter the context configuration mode.

```
[local]host_name(config)# context context_name
[local]host_name(config-ctx)#
```

Step 2 Go to the SSH Configuration mode.

```
[local]host_name(config-ctx)# server sshd
```

Step 3 Configure the SSH user list.

```
[local]host_name(config-sshd)# allowusers add user_list
```

user_list specifies a list of user name patterns, separated by spaces, as an alphanumeric string of 1 through 999 characters. If the pattern takes the form 'USER' then login is restricted for that user.

If the pattern is in the format 'USER@IP_ADDRESS' then user name and IP address are separately checked, restricting logins to those users from that particular IP address.

If the pattern is in the format 'USER@<context>@IP_ADDRESS' then user name, StarOS context and IP address are separately checked, restricting logins to those users associated with the specific context from that particular IP address.

The following limits apply to the *user_list*:

- The maximum length of this string is 3000 bytes including spaces.
- The maximum number of AllowUsers, which is counted by spaces, is 256, which is consistent with the limit from OpenSSH.

Important If you exceed either of the above limits, an error message is displayed. The message prompts you to use a regular expression pattern to shorten the string, or remove all the allowusers with **no allowusers add** or **default allowusers add** and re-configure.

For additional information, see the *SSH Configuration Mode Commands* chapter in the *Command Line Interface Reference*.

Step 4 Exit the SSH Configuration mode.

```
[local]host_name(config-sshd)# end
[local]host_name#
```

SSH User Login Authentication

StarOS authenticates SSH user login attempts via authorized-key/user-account pairings for the following scenarios:

- User tries to login with local context username through local context (VPN) interface with authorized-key configured on local context.

- User tries to login with non-local context username through non-local context interface with authorized-key configured on non-local context.
- User tries to login with local context username through non-local context interface with authorized-key configured on local context.
- User tries to login with non-local context username through local context interface with authorized-key configured on non-local context.

A failure to authenticate based on the current system configuration prevents the login and generates an error message.

StarOS does not permit users with different user IDs but having the same public SSH key to login to an unauthorized context. Authentication of the user takes into account the authorized-key/user-account pairing.



Important

For StarOS release 21.0 onwards, a user cannot access the /flash directory if the user logs in from a non-local context.

Secure Session Logout

When StarOS is disconnected from an SSH client, the default behavior has sshd terminate the CLI or SFTP session in about 45 seconds (using default parameters). Two SSH Configuration mode CLI commands allow you to disable or modify this default sshd disconnect behavior.



Important

For higher security, Cisco recommends at least a client-alive-countmax of 2 and client-alive-interval of 5. Smaller session logout values may lead to occasional ssh session logouts. Adjust values to balance security and user friendliness.

The **client-active-countmax** command sets the number of client-alive messages which may be sent without sshd receiving any messages back from the SSH client (default =3). If this threshold is reached while the client-alive messages are being sent, sshd disconnects the SSH client thus terminating the session.

The **client-alive-interval** command sets a timeout interval in seconds (default = 15) after which if no data has been received from the SSH client, sshd sends a message through the encrypted channel to request a response from the client. The number of times that the message is sent is determined by the client-alive-countmax parameter. The approximate amount of time before sshd disconnects an SSH client disconnect = client-alive-countmax X client-alive-interval.

The client-alive mechanism is valuable when the client or server depend on knowing when a connection has become inactive.



Important

The client-alive messages are sent through the encrypted channel and, therefore, are not spoofable.



Important

These parameter apply to SSH protocol version 2 only.

Changing Default sshd Secure Session Logout Parameters

The following command sequence modifies the default settings for the ClientAliveCountmax (default = 3) and ClientAliveInterval (default = 15 seconds) parameters.

-
- Step 1** Enter the context configuration mode.
- ```
[local]host_name# configure
```
- Step 2** Go to the SSH Configuration mode.
- ```
[local]host_name(config)# context context_name
```
- Step 3** Set the ClientAliveCountmax parameter to 2.
- ```
[local]host_name(config-sshd)# client-alive-countmax 2
```
- Step 4** Set the ClientAliveInterval parameter to 5 seconds.
- ```
[local]host_name(config-sshd)# client-alive-interval 5
```
- Step 5** Exit the SSH Configuration mode.
- ```
[local]host_name(config-sshd)# end
[local]host_name#
```
- 

## SSH Client Login to External Servers

StarOS supports public key authentication for SSH/SFTP access from the StarOS gateway to external servers. You configure this feature by generating SSH client key pairs and pushing the client public key to external servers



---

**Note** By default StarOS only supports username-password authentication to external servers.

---

## Setting SSH Client Ciphers

The SSH Client Configuration mode **ciphers** CLI command configures the cipher priority list when logging into an external server.

- 
- Step 1** Enter the SSH Client Configuration mode.
- ```
[local]host_name(config)# client ssh
```
- Step 2** Specify the desired encryption algorithms.
- ```
[local]host_name(config-ssh)# ciphers algorithms
```

Notes:

- *algorithms* is a string of 1 through 511 alphanumeric characters that specifies the algorithm(s) to be used as a single string of comma-separated variables (no spaces) in priority order (left to right) from those shown below:

- **blowfish-cbc** – symmetric-key block cipher, Cipher Block Chaining, (CBC)
- **3des-cbc** – Triple Data Encryption Standard, CBC
- **aes128-cbc** – Advanced Encryption Standard (AES), 128-bit key size, CBC
- **aes128-ctr** – AES, 128-bit key size, Counter-mode encryption (CTR)
- **aes192-ctr** – AES, 192-bit key size, CTR
- **aes256-ctr** – AES, 256-bit key size, CTR
- **aes128-gcm@openssh.com** – AES, 128-bit key size, Galois Counter Mode [GCM], OpenSSH
- **aes256-gcm@openssh.com** – AES, 256-bit key size, GCM, OpenSSH
- **chacha20-poly1305@openssh.com** – ChaCha20 symmetric cipher, Poly1305 cryptographic Message Authentication Code [MAC], OpenSSH

The default string for *algorithms* in a Normal build is:

```
aes256-ctr,aes192-ctr,aes128-ctr,aes256-gcm@openssh.com,aes128-gcm@openssh.com,chacha20-poly1305@openssh.com,blowfish-cbc,3des-cbc,aes128-cbc
```

The default string for *algorithms* in a Trusted build is:

```
aes256-ctr,aes192-ctr,aes128-ctr
```

**Step 3** Exit the SSH Client Configuration mode.

```
[local]host_name(config-ssh)# end
[local]host_name#
```

---

## Setting Preferred Authentication Methods

The SSH Client Configuration mode **preferredauthentications** CLI command configures the preferred methods of authentication.

**Step 1** Enter the SSH Client Configuration mode.

```
[local]host_name(config)# client ssh
```

**Step 2** Specify the preferred authentication methods.

```
[local]host_name(config-ssh)# preferredauthentications methods
```

Notes:

- *methods* – specifies the preferred methods of authentication to be used as a single string of comma-separated variables (no spaces) in priority order (left to right) from those shown below:
  - **publickey** – authentication via SSH v2-RSA protocol.
  - **keyboard-interactive** – request for an arbitrary number of pieces of information. For each piece of information the server sends the label of the prompt.
  - **password** – simple request for a single password
- **default** – resets the value of methods to: publickey,password

**Step 3** Exit the SSH Client Configuration mode.

```
[local]host_name(config-ssh)# exit
[local]host_name(config)#
```

---

## Generating SSH Client Key Pair

You use commands in the SSH Client Configuration mode to specify a private key and generate the SSH client key pair.

---

**Step 1** Enter the SSH client configuration mode.

```
[local]host_name(config)# client ssh
[local]host_name(config-ssh)#
```

**Step 2** Enter SSH private key information and key type.

```
[local]host_name(config-ssh)# ssh key private_key_string length key_length [type v2-rsa]
[local]host_name(config-ssh)#
```

**key private\_key\_string** specifies a private key value as an alphanumeric string of 1 through 4499 characters.

**length key\_length** specifies the length of the key in bytes as an integer from 0 through 65535.

**type v2-rsa** specifies the SSH client key type. The only supported SSH client key type is **v2-rsa**.

**Step 3** Generate SSH client key pair.

```
[local]host_name(config-ssh)# ssh generate key [type v2-rsa]
[local]host_name(config-ssh)#
```

**type v2-rsa** specifies the SSH client key type. The only supported SSH client key type is **v2-rsa**.

**Step 4** Verify that the SSH client key has been generated.

```
[local]host_name(config-ssh)# do show ssh client key
```

**Step 5** Exit the SSH Client Configuration mode.

```
[local]host_name(config-ssh)# exit
[local]host_name(config)#
```

---

## Pushing an SSH Client Public Key to an External Server

You must push the SSH client public key to an external server to support SSH/SFTP access to that server.

---

**Step 1** From the Exec mode run the **push ssh-key** command.

```
[local]host_name# push ssh-key { host_name | host_ip_address } user username [context context_name]
[local]host_name#
```

*host\_name* specifies the remote server using its logical host name which must be resolved via DNS lookup. It is expressed as an alphanumeric string of 1 to 127 characters.

*host\_ip\_address* is expressed in IPv4 dotted-decimal or IPv6 colon-separated-hexadecimal notation.

**user** *username* specifies a valid username on the external server as an alphanumeric string of 1 to 79 characters.

**context** *context\_name* specifies a valid context name. The context name is optional. If it is not provided the current context is used for processing.

**Step 2** Repeat Step 1 to support SSH/SFTP access on other external servers.

**Step 3** Test SSH client login to an external server.

```
local]host_name# ssh { hostname | ip_address } user username port port_number
```

## Enabling NETCONF

An SSH key is a requirement before NETCONF protocol and the ConfD engine can be enabled in support of Cisco Network Service Orchestrator (NSO).

Refer to the *NETCONF and ConfD* appendix in this guide for detailed information on how to enable NETCONF.

## Configuring the Management Interface with a Second IP Address

If necessary, you can configure a second IP address on the MIO/UMIO/MIO2 management interface.

**Step 1** Enter the configuration mode by entering the following command at the prompt:

```
[local]host_name# configure
[local]host_name(config)#
```

**Step 2** Enter the following to enter the context configuration mode:

```
[local]host_name(config)# context local
[local]host_name(config-ctx)#
```

**Step 3** Enter the interface slot number and port number by entering the following command:

```
[local]host_name(config-ctx)# 5/1
[local]host_name(config-if-eth)#
```

**Step 4** Enter the secondary IP address and subnet mask by entering the following command:

```
[local]host_name(config-if-eth)# { ip | ipv } address ipaddress subnet_mask secondary
```

**Step 5** Exit the configuration mode by entering the following command:

```
[local]host_name(config-if-eth)# end
```

**Step 6** Confirm the interface IP addresses by entering the following command:

```
[local]host_name# show config context local
```

The CLI output should look similar to this example:

```
config
 context local
 interface interface_name
 ip address ipaddress subnetmask
 ip address ipaddress subnetmask secondary
 #exit
```

**Step 7** Save your configuration as described in *Verifying and Saving Your Configuration*.

---







## CHAPTER 3

# System Settings

This chapter provides instructions for configuring the following StarOS options.

It is assumed that the procedures to initially configure the system as described in *Getting Started* have been completed.



### Important

The commands used in the configuration examples in this section are the most likely-used commands and/or keyword options. In many cases, other optional commands and/or keyword options are available. Refer to the *Command Line Interface Reference* for complete information.

- [Configuring a Second Management Interface, on page 45](#)
- [Verifying and Saving Your Interface and Port Configuration, on page 46](#)
- [Configuring System Timing, on page 47](#)
- [Configuring SF Boot Configuration Pause, on page 51](#)
- [Enabling CLI Timestamping, on page 51](#)
- [Configuring CLI Confirmation Prompts, on page 52](#)
- [Configuring System Administrative Users, on page 54](#)
- [Configuring TACACS+ for System Administrative Users, on page 63](#)
- [IPv6 Address Support for TACACS+ Server, on page 67](#)
- [Separating Authentication Methods, on page 67](#)
- [Configuring a Chassis Key, on page 70](#)
- [Configuring MIO/UMIO/MIO2 Port Redundancy, on page 72](#)
- [Configuring Data Processing Card Availability, on page 75](#)
- [Enabling Automatic Reset of FSC Fabric, on page 76](#)
- [Configuring ASR 5500 Link Aggregation, on page 76](#)
- [Configuring a Demux Card, on page 83](#)

## Configuring a Second Management Interface

Refer to *Getting Started* for instructions on configuring a system management interface on the Management Input/Output (MIO/UMIO/MIO2) card. This section provides described how to configure a second management interface.

Use the following example to configure a second management interface:

```

configure
 context local
 interface interface_name
 ip address ipaddress subnetmask
 exit
 ip route 0.0.0.0 0.0.0.0 gw_address interface_name
 exit
 port ethernet slot#/port#
 bind interface interface_name local
 no shutdown
 media rj45
 end

```

Notes:

- For **port ethernet** *slot#*, use the actual chassis slot in which the active MIO/UMIO/MIO2 resides (slot number 5 or 6).
- Enter IP addresses using IPv4 dotted-decimal or IPv6 colon-separated-hexadecimal notation.
- For **port ethernet** *port#*, use the physical port on the MIO/UMIO/MIO2 card – port 1 or 2.
- The MIO/UMIO/MIO2 is equipped with RJ-45 (1000Base-T copper) interfaces. The RJ-45 interfaces connect the system to the management network via CAT3 or CAT5 Ethernet cable.
- *Option:* In the Ethernet Port configuration mode, configure the port speed, if needed, by entering the **medium** command. Refer to the *Command Line Interface Reference* for a complete explanation of this command.
- In the { **ip** | **ipv6** } **route** command, other keyword options, instead of the gateway IP address, are available and include: **next-hop** IP address, **point-to-point**, and **tunnel**.

## Verifying and Saving Your Interface and Port Configuration

Verify that your interface configuration settings are correct by entering the following command:

```
show ip interface
```

The output from this command should be similar to that shown below. In this example an interface named *mgmt2* was configured in the local context.

```

Intf Name: mgmt2
Intf Type: Broadcast
Description: management2
VRF: None
IP State: UP (Bound to 5/2)
IP Address: 192.168.100.3 Subnet Mask: 255.255.255.0
Bcast Address: 192.168.100.255 MTU: 1500
Resoln Type: ARP ARP timeout: 60 secs
L3 monitor LC-port switchover: Disabled
Number of Secondary Addresses: 0

```

Verify that the port configuration settings are correct by entering the following command:

```
show configuration port slot#/port#
```

*slot#* is the chassis slot number of the line card where the physical port resides. *slot#* is either 5 or 6. *port#* is the number of the port (either 1 or 2).

This following command produces an output similar to the one shown below. It displays the configuration of port 2 of the MIO/UMIO/MIO2 installed in chassis slot 5. In this example, the port is bound to an interface called *mgmt2*.

```
config
 port ethernet 5/2
 description management2
 no shutdown
 bind interface mgmt2 local
end
```

Save your configuration as described in the *Verifying and Saving Your Configuration* chapter.

## Configuring System Timing

The system is equipped with a clock that supplies the timestamp for statistical counters, accounting records, logging, and event notification. After the initial configuration of the system clock, you can configure the system to communicate with one or more Network Time Protocol (NTP) server(s) to ensure that the clock is always accurate.

In the event of a power outage, the clock is maintained with an accuracy of  $\pm$  one minute per month for up to 10 years. This ensures that when power is restored, the system is ready to process sessions and generate accounting, log, and event data with accurate timestamps.

In addition to configuring the timing source, you must configure the system's time zone.

## Setting the System Clock and Time Zone

Use the following command example to configure the system clock and time zone:

```
clock set date:time
configure
 clock timezone timezone [local]
end
```

Notes:

- Enter the date and time in the format YYYY:MM:DD:HH:mm or YYYY:MM:DD:HH:mm:ss.
- Refer to the online Help for the **clock timezone** command for a complete list of supported time zones.
- The optional **local** keyword indicates that the time zone specified is the local timezone.
- Daylight Savings Time is automatically adjusted for time zones supporting it.

Save your configuration as described in the *Verifying and Saving Your Configuration* chapter.

## Verifying and Saving Your Clock and Time Zone Configuration

Enter the following command to verify that you configured the time and time zone correctly:

```
show clock
```

The output displays the date, time, and time zone that you configured.

## Configuring Network Time Protocol Support

This section provides information and instructions for configuring the system to enable the use of the Network Time Protocol (NTP).



### Important

Configure the system clock and time zone prior to implementing NTP support. This greatly reduces the time period that must be corrected by the NTP server.

Many of the services offered by the StarOS require accurate timekeeping derived through NTP. If the time reference(s) used by StarOS are not accurate, the services may be unreliable. For this reason it should be assumed that normal system operation requires that NTP be configured.

The system uses NTP to synchronize its internal clock to external time sources (typically GPS NTP sources, or other Stratum 2 or 3 servers, switches or routers).

By default, NTP is not enabled externally and should be configured when the system is initially installed. When enabled, the active MIO/UMIO/MIO2 will synchronize with external sources. If not enabled, the active MIO/UMIO/MIO2 will use its local clock as a time source. In the event of an NTP server or network outage, an already running MIO/UMIO/MIO2 will continue to use NTP to maintain time accuracy, but in a holdover mode.

All cards with CPUs synchronize to the active MIO/UMIO/MIO2 internally. This occurs even if an external NTP server is not configured. In the event of a MIO/UMIO/MIO2 switchover, all other cards will start synchronizing with the newly active MIO/UMIO/MIO2 automatically.

The system should have:

- NTP enabled.
- NTP configured for use in the local context only. Use of other contexts (which can be specified in the enable configurable) will cause issues.
- NTP configured for at least three external NTP servers. With three or more servers, outliers and broken or misconfigured servers can be detected and excluded. Generally, the more servers the better (within reason).



### Important

Do not configure any external NTP servers using the **prefer** keyword. The NTP clock selection algorithms already have the built-in ability to pick the best server. Use of **prefer** usually results in a poorer choice than NTP can determine for itself.



### Important

Do not change the **maxpoll**, **minpoll**, or **version** keyword settings unless instructed to do so by Cisco TAC.

Use the following example to configure the necessary NTP association parameters:

```
configure
 ntp
```

```

enable
server ip_address1
server ip_address2
server ip_address3
end

```

Notes:

- By default *context\_name* is set to *local*. This is the recommended configuration.
- A number of options exist for the **server** command. Refer to the *NTP Configuration Mode Commands* chapter in the *Command Line Interface Reference* for more information.
- Enter the IP address of NTP servers using IPv4 dotted-decimal or IPv6 colon-separated-hexadecimal notation.



### Important

Configure the system with at least three (preferably four) NTP servers.

Save the configuration as described in the *Verifying and Saving Your Configuration* chapter.

## Configuring NTP Servers with Local Sources

NTP can use network peers, local external clocks (such as GPS devices), or a local clock with no external source.

A local clock with no external source is usually a last-resort clock when no better clock is available. It is typically configured on a site's intermediate NTP server so that when a WAN network outage occurs, hosts within the site can continue to synchronize amongst themselves.

You can configure this in `ntpd` or on many commercially available NTP devices. This local clock should always have a high stratum number (8+) so that under normal conditions (when real sources are available) this local clock will not be used.

## Using a Load Balancer

The NTP daemon and protocol assume that each configured server is running NTP. If a NTP client is configured to synchronize to a load balancer that relays and distributes packets to a set of real NTP servers, the load balancer may distribute those packets dynamically and confuse the NTP client. NTP packets are latency and jitter sensitive. Relaying them through a load balancer can confuse the NTP client and is not a supported practice.

## Verifying the NTP Configuration

Verify the NTP configuration is correct. Enter the following command at the Exec mode prompt:

```
show ntp associations
```

The output displays information about all NTP servers. See the output below for an example deploying two NTP servers.

```

+----Peer Selection: () - Rejected / No Response
| (x) - False Tick

```

```

| (.) - Excess
| (-) - Outlyer
| (+) - Candidate
| (#) - Selected
| (*) - System Peer
| (o) - PPS Peer
v
 remote refid st t when poll reach delay offset jitter
=====
*10.81.254.202 .GPS. 1 u 160 1024 377 21.516 0.019 0.009

```

The following table describes the parameters output by the **show ntp associations** command.

**Table 3: NTP Parameters**

| Column Title | Description                                                                                                                                                                                                                                                                                                                                                           |
|--------------|-----------------------------------------------------------------------------------------------------------------------------------------------------------------------------------------------------------------------------------------------------------------------------------------------------------------------------------------------------------------------|
| remote       | List of the current NTP servers. One of these characters precedes each IP address to show the server's current condition: <ul style="list-style-type: none"> <li>• ( ) Rejected/No response</li> <li>• X False tick</li> <li>• . Excess</li> <li>• - Outlyer</li> <li>• + Candidate</li> <li>• # Selected</li> <li>• * System peer</li> <li>• (o) PPS peer</li> </ul> |
| refid        | Last reported NTP reference to which the server is synchronizing.                                                                                                                                                                                                                                                                                                     |
| st           | NTP server stratum level.                                                                                                                                                                                                                                                                                                                                             |
| t            | Communication type: broadcast, multicast, etc.                                                                                                                                                                                                                                                                                                                        |
| when         | Number of seconds since the last contact.                                                                                                                                                                                                                                                                                                                             |
| poll         | Polling interval between the system and the NTP server.                                                                                                                                                                                                                                                                                                               |
| reach        | Octal value of the reachability shift register indicating which responses were received for the previous eight polls to this NTP server.                                                                                                                                                                                                                              |
| delay        | Round-trip delay (in milliseconds) for messages exchanged between the system and the NTP server.                                                                                                                                                                                                                                                                      |
| offset       | Number of milliseconds by which the system clock must be adjusted to synchronize it with the NTP server.                                                                                                                                                                                                                                                              |

| Column Title | Description                                                   |
|--------------|---------------------------------------------------------------|
| jitter       | Jitter in milliseconds between the system and the NTP server. |

## Configuring SF Boot Configuration Pause

Under certain circumstances, within VPC-DI deployments, the CF applies the boot configuration before all SFs have completed their boot process.

The following Configuration Mode command, **wait cards active**, pauses configuration until all specified cards are operational or the timeout period expires (whichever criteria is met first). The pause occurs immediately following local management context creation and ntp/snmp configuration.

This command corrects a scenario where SFs come online late following chassis load or reload and the configuration pertaining to those SFs is not applied (and thereby lost).

### configure

```
[no] wait cards active { all | number } [standby number] timeout seconds
end
```

Notes:

- **all**: Pause until all active mode cards attain operational status.
- **number** : Pause until the specified number of active mode cards attain operational status. *number* is 0 through the number of active mode cards.
- **standby number** : (Optional) Also wait for the specified number of non-active mode cards to attain operational status.  
*number* is 0 through the number of service slots not configured for active mode SFs.
- **timeout seconds**: Wait from 1 through 3600 *seconds* for the specified card set to attain operational status. The wait is terminated early when or if this condition is satisfied. Otherwise the wait is terminated when the timeout period expires.

The following example command instructs the system to wait up to 120 seconds for all active cards and 1 standby card to become active:

```
wait cards active all standby 1 timeout 120
```

## Enabling CLI Timestamping

To display a timestamp (date and time) for every command that is executed on the CLI, enter the following command at the root prompt for the Exec mode:

```
timestamps
```

The date and time appear immediately after you execute the command.

Save the configuration as described in the *Verifying and Saving Your Configuration* chapter.

## Configuring CLI Confirmation Prompts

A number of Exec mode and Global Configuration mode commands prompt users for a confirmation (Are you sure? [Yes|No]:) prior to executing the command.

This section describes configuration settings that:

- Automatically confirm commands for the current CLI session (Exec mode) or for all CLI sessions and users (Global Configuration mode).
- Requires confirmation prompting only for the Exec mode **configure** command and **autoconfirm** command.
- Selectively requires confirmation of Exec mode configuration commands.

## Enabling Automatic Confirmation

You can use the **autoconfirm** command to disable confirmation prompting for configuration commands. The **autoconfirm** command is available in the Exec mode and Global Configuration mode. Enabling the autoconfirm feature automatically supplies a "Yes" response to configuration command prompts, including for critical commands such as **reload** and **shutdown**. By default autoconfirm is disabled.

In the Exec mode, autoconfirm applies only to the current interactive CLI session.

In the Global Configuration mode, autoconfirm applies to all CLI sessions for all CLI users:

```
configure
 autoconfirm
end
```

To disable autoconfirm once it has been enabled, use the **no autoconfirm** command.



### Important

If commandguard is enabled, autoconfirm will disable commandguard.

Autoconfirm is intended as an "ease-of-use" feature. It presumes that the answer to "Are you sure? [Y/N]" prompts will be "Yes", and skips the prompt. Its use implies that the user is an expert who does not need these "safety-net" prompts.

## Requiring Confirmation for autoconfirm and configure Commands

You can require confirmation prompting for the **autoconfirm** (Exec mode and Global Configuration mode) and **configure** (Exec mode) commands via the Global Configuration mode **commandguard** command.



### Important

If autoconfirm is enabled, commandguard will not take effect until autoconfirm is disabled in both Exec and Global Configuration modes.

The following command sequence enables the commandguard feature:

```
configure
 commandguard
end
```



With **commandguard** enabled the confirmation prompt appears as shown in the example below:

```
[local]host_name# configure
Are you sure? [Yes|No]: yes
[local]host_name(config)#
```

To disable **commandguard** once it has been enabled, use the **no commandguard** command.

The status of **commandguard** is output in **show configuration** commands.

## Requiring Confirmation for Specific Exec Mode Commands

A keyword for the **commandguard** command allows you to apply mandatory prompting for specified categories of Exec mode configuration commands, even when **autoconfirm** is enabled.

The command syntax is as follows:

```
configure
 commandguard exec-command exec_mode_category
end
```

Notes:

- **exec-command** *exec\_mode\_category* specifies one of the following categories of Exec mode configuration commands.
  - card
  - clear
  - copy
  - debug
  - delete
  - filesystem
  - hd
  - reload
  - rename
  - shutdown
  - task
  - upgrade
- You can enter multiple **commandguard exec-command** *exec\_mode\_category* commands.
- All Exec mode commands beginning with the specified category word will prompt for confirmation, regardless if **autoconfirm** is enabled.
- You can turn off confirmation prompting for a specific category using **no commandguard exec-command** *exec\_mode\_category*.
- If **autoconfirm** is overridden by **commandguard exec-command** for an Exec mode command, StarOS displays an informational message indicating why **autoconfirm** is being overridden when you attempt to execute the command.
- Users may selectively override confirmation prompting for any Exec mode configuration command that supports the **-noconfirm** keyword.

For example, with **commandguard exec-command card** enabled, the confirmation prompt appears as shown below:

```
[local]host_name# card busy-out 1
Info: commandguard prevents autoconfirm of this command
```

```
Are you sure? [Yes|No]: yes
[local]host_name#
```

## Configuring System Administrative Users

*Getting Started* describes how to configure a context-level security administrator for the system.

This section provides instructions for configuring additional administrative users having the following privileges:

- **Security Administrators:** have read-write privileges and can execute all CLI commands, including those available to Administrators, Operators, and Inspectors
- **Administrators:** have read-write privileges and can execute any command in the CLI except for a few security-related commands that can only be configured by Security Administrators. Administrators can configure or modify system settings and execute all system commands, including those available to the Operators and Inspectors.
- **Operators:** have read-only privileges to a larger subset of the Exec Mode commands. They can execute all commands that are part of the inspector mode, plus some system monitoring, statistic, and fault management functions. Operators do not have the ability to enter the Config Mode.
- **Inspectors:** are limited to a few read-only Exec Mode commands. The bulk of these are **show** commands for viewing a variety of statistics and conditions. An Inspector cannot execute **show configuration** commands and does not have the privilege to enter the Config Mode.

Configuration instructions are categorized according to the type of administrative user: context-level or local-user.



### Important

For information on the differences between these user privileges and types, refer to *Getting Started*.

## User Name Character Restrictions

User names can only contain alphanumeric characters (a-z, A-Z, 0-9), hyphen, underscore, and period. The hyphen character cannot be the first character. This applies to AAA user names as well as local user names.

If you attempt to create a user name that does not adhere to these standards, you will receive the following message: "Invalid character; legal characters are "0123456789.-\_abcdefghijklmnopqrstuvwxyzABCDEFGHIJKLMNOPQRSTUVWXYZ".

## Configuring Context-level Administrative Users

This user type is configured at the context-level and relies on the AAA subsystems for validating user names and passwords during login. This is true for both administrative user accounts configured locally through a configuration file or on an external RADIUS or TACACS+ server. Passwords for these user types are assigned once and are accessible in the configuration file.

This section contains information and instructions for configuring context-level administrative user types.

It is possible to configure the maximum number of simultaneous CLI sessions on a per account or per authentication method basis. It will protect certain accounts that may have the ability to impact security configurations and attributes or could adversely affect the services, stability and performance of the system. The maximum number of simultaneous CLI sessions is configurable when attempting a new Local-User login and a new AAA context-based login. If the maximum number of sessions is set to 0, then the user is authenticated regardless of the login type. When the CLI task starts, a check is complete to identify the count. In this case, the CLI determines that the sessions for that user is 1 which is greater than 0 and it will display an error message in the output, it generate starCLIActiveCount and starCLIMaxCount SNMP MIB Objects and starGlobalCLISessionsLimit and starUserCLISessionsLimit SNMP MIB Alarms.

The **max-sessions** keyword for the **local-user username** *Global Configuration Mode* command configures the maximum number of simultaneous sessions available for a local user.

The **max-sessions** *Context Configuration Mode* command allows administrative users to configure the maximum simultaneous sessions allowed for corresponding users.

Refer to the *Command Line Interface Reference* for detailed information about these commands.

## Configuring Context-level Security Administrators

Use the example below to configure additional security administrators:

```
configure
 context local
 administrator user_name { [encrypted] [nopassword] password password
 }
end
```

Notes:

- Additional keyword options are available that identify active administrators or place time thresholds on the administrator. Refer to the *Command Line Interface Reference* for more information about the **administrator** command.
- The **nopassword** option allows you to create an administrator without an associated password. Enable this option when using ssh public keys (**authorized key** command in SSH Configuration mode) as a sole means of authentication. When enabled this option prevents someone from using an administrator password to gain access to the user account.

Save the configuration as described in the *Verifying and Saving Your Configuration* chapter.

## Configuring Context-level Administrators

Use the example below to configure context-level configuration administrators:

```
configure
 context local
 config-administrator user_name { [encrypted] [nopassword] password
 password }
end
```

Notes:

- Additional keyword options are available that identify active administrators or place time thresholds on the administrator. Refer to the *Command Line Interface Reference* for more information about the **config-administrator** command.

- The **nopassword** option allows you to create a config-administrator without an associated password. Enable this option when using ssh public keys (**authorized key** command in SSH Configuration mode) as a sole means of authentication. When enabled this option prevents someone from using a config-administrator password to gain access to the user account.

Save the configuration as described in the *Verifying and Saving Your Configuration* chapter.

## Configuring Context-level Operators

Use the example below to configure context-level operators:

```
configure
 context local
 operator user_name { [encrypted] [nopassword] password password }
 end
```

Notes:

- Additional keyword options are available that identify active administrators or place time thresholds on the administrator. Refer to the *Command Line Interface Reference* for more information about the **operator** command.
- The **nopassword** option allows you to create an operator without an associated password. Enable this option when using ssh public keys (**authorized key** command in SSH Configuration mode) as a sole means of authentication. When enabled this option prevents someone from using an operator password to gain access to the user account.

Save the configuration as described in the *Verifying and Saving Your Configuration* chapter.

## Configuring Context-level Inspectors

Use the example below to configure context-level inspectors:

```
configure
 context local
 inspector user_name { [encrypted] [nopassword] password password }
 end
```

Notes:

- Additional keyword options are available that identify active administrators or place time thresholds on the administrator. Refer to the *Command Line Interface Reference* for more information about the **inspector** command.
- The **nopassword** option allows you to create an inspector without an associated password. Enable this option when using ssh public keys (**authorized key** command in SSH Configuration mode) as a sole means of authentication. When enabled this option prevents someone from using an inspector password to gain access to the user account.

Save the configuration as described in the *Verifying and Saving Your Configuration* chapter.

## Configuring LI Administrators



### Important

For security reasons, **li-administration** accounts must be restricted for use only with Lawful Intercept (LI) functionality and not for general system administration. Only security administrators and administrators can provision LI privileges. To ensure security in accordance with Law Enforcement Agency (LEA) standards, LI administrative users must access the system using the Secure Shell (SSH) protocol only. LI privileges can be optionally configured for use within a single context system-wide. For additional information, see the *Lawful Intercept Configuration Guide* and [Provisioning Lawful Intercept, on page 61](#).

Use the example below to configure a context-level LI administrator:

```
configure
 context context_name
 administrator user_name { [encrypted] [nopassword] password password
 li-administrator}
 end
```

LI Administrators and non-LI Administrators can configure Lawful-Intercept CLI commands. However, only LI Administrators can view the encrypted Lawful-Intercept CLI commands in Trusted Builds and in Normal builds, if the Global Configuration mode **require segregated li-configuration** command is enabled. For additional information, see the *Lawful Intercept Configuration Guide* and [Segregating System and LI Configurations, on page 57](#).

## Segregating System and LI Configurations

Lawful Intercept (LI) configuration includes sensitive information. By default in a Normal build, an administrator without li-administration privilege can view the LI configuration commands. However, display of the LI configuration commands can be restricted or segregated from the rest of the system configuration.

The Global Configuration mode **require segregated li-configuration** command permanently segregates display of System and Lawful Intercept CLI. The CLI commands with Lawful-Intercept keyword are encrypted and can only be viewed by an administrator with li-administration privilege.



### Important

In a Trusted build, LI segregation is turned on and cannot be disabled. The **require segregated li-configuration** command is invisible.

Segregating LI configuration from system configuration has the following impacts on StarOS:

- Only administrators with li-administration privilege can see Lawful Intercept CLI commands in the output of the **show configuration** command.
- Executing the **save configuration** command will automatically encrypt Lawful Intercept CLI configuration commands.
- When loading a saved configuration file via CLI command (for example, **configure <url>**), encrypted Lawful Intercept CLI commands will be decrypted and executed only for an administrator with LI privilege. For an administrator without LI privilege, encrypted Lawful Intercept CLI commands will not be decrypted and executed.

- During a system boot wherein the boot config is loaded, encrypted Lawful Intercept configuration will be decrypted and loaded silently, in other words Lawful Intercept CLI configuration will not be visible on the console port.
- The Exec mode **configure** command now supports a keyword that allows an LI administrator to load only encrypted Lawful Intercept configuration from a saved configuration file (for example, **configure encrypted <url>**). The **encrypted** keyword can only be executed by an LI Administrator.
- If you are running a system with encrypted Lawful Intercept configuration (segregated LI), the output of the **show boot initial-config** command contains a line indicating whether it needed to run the second pass or not during the initial boot. This line displays "encrypted li" if the encrypted Lawful Intercept configuration was processed. If the line reads "encrypted li errors" then the second pass was not successful, or gave some output which was not expected or informational in nature.
- A user with li-administration privileges can view the boot config output for the encrypted Lawful Intercept configuration with the **show logs encrypted-li** command.

For a detailed description of the Global Configuration mode **require segregated li-configuration** and associated commands, see the *Lawful Intercept CLI Commands* appendix in the *Lawful Intercept Configuration Guide*.




---

**Note** The *Lawful Intercept Configuration Guide* is not available on [www.cisco.com](http://www.cisco.com). Contact your Cisco account representative to obtain a copy of this guide.

---

In Release 21.4 and higher (Trusted builds only):

- Users can only access the system through their respective context interface.
- If the user attempts to log in to their respective context through a different context interface, that user will be rejected.
- Irrespective of whether the users are configured in any context with 'authorized-keys' or 'allowusers', with this feature these users will be rejected if they attempt to log in via any other context interface other than their own context interface.
- Users configured in any non-local context are required to specify which context they are trying to log in to. For example:

```
ssh username@ctx_name@ctx_ip_addr
```

## Verifying Context-level Administrative User Configuration

Verify that the configuration was successful by entering the following command:

```
show configuration context local
```

This command displays all of the configuration parameters you modified within the Local context during this session. The following displays sample output for this command. In this example, a security administrator named *testadmin* was configured.

```
config
context local
 interface mgmt1
 ip address 192.168.1.10 255.255.255.0
 #exit
subscriber default
```

```

#exit
administrator testadmin encrypted password fd01268373c5da85
inspector testinspector encrypted password 148661a0bb12cd59
exit
port ethernet 5/1
 bind interface mgmt1 local
#exit

```

## Configuring Local-User Administrative Users

The local user type supports ANSI T1.276-2003 password security protection. Local-user account information, such as passwords, password history, and lockout states, is maintained in /flash. This information is saved immediately in a separate local user database subject to AAA based authentication and is not used by the rest of the system. As such, configured local-user accounts are not visible with the rest of the system configuration.



### Important

In release 20.0 and higher Trusted StarOS builds, the local user database is disabled. The Global Configuration mode **local-user** commands, and Exec mode **show local-user** and **update local-user** commands are unavailable. For additional information on Trusted builds, see the *System Operation and Configuration* chapter.

Use the example below to configure local-user administrative users:

```

configure
 local-user username name
end

```

Notes:

- Additional keyword options are available identify active administrators or place time thresholds on the administrator. Refer to the *Command Line Interface Reference* for more information about the **local-user username** command.

For additional information on the local-user database, see [Updating and Downgrading the local-user Database, on page 60](#).

## Verifying Local-User Configuration

Verify that the configuration was successful by entering the following command:

```
show local-user verbose
```

This command displays information on configured local-user administrative users. A sample output for this command appears below. In this example, a local-user named *SAUser* was configured.

```

Username: SAUser
Auth Level: secadmin
Last Login: Never
Login Failures: 0
Password Expired: Yes
Locked: No
Suspended: No
Lockout on Pw Aging: Yes
Lockout on Login Fail: Yes

```

## Updating Local-User Database

Update the local-user (administrative) configuration by running the following Exec mode command. This command should be run immediately after creating, removing or editing administrative users.

```
update local-user database
```

## Updating and Downgrading the local-user Database

Prior to release 20.0, local-user passwords were hashed with the MD5 message digest-algorithm and saved in the local-user database. In release 20.0, PBKDF2 (Password Based Key Derivation Function - Version 2) is now used to derive a key of given length, based on entered data, salt and number of iterations. Local-user account passwords are hashed using the PBKDF2 method with a randomly generated salt coupled with a large number of iterations to make password storage more secure.

When upgrading to release 20.0, existing user passwords in the local-user database are not automatically upgraded from MD5 to PBKDF2 hashing (only hashed password values are stored). Since hash functions are one-way, it is not possible to derive user passwords from the stored hash values. Thus it is not possible to convert existing hashed passwords to strongly hashed passwords automatically.

To update the database, a Security Administrator must run the Exec mode **update local-user database** CLI command. When this command is executed, StarOS reads the database from the /flash directory, reconstructs the database in the new format, and writes it back to the disk.

The database upgrade process does not automatically convert MD5 hashed passwords into the PBKDF2 format. StarOS continues to authenticate users using the old encryption algorithm. It flags the users using the old encryption algorithm with a "Weak Hash" flag. This flag appears in the output of the **show local-user [verbose]** Exec mode CLI command. When users re-login with their credentials, StarOS verifies the entered password using the MD5 algorithm, then creates a new hash using the PBKDF2 algorithm and then saves the result in the database. StarOS then clears the "Weak Hash" flag for that user.



### Important

Since hash functions are one-way, it is not possible to convert PBKDF2 hashed passwords to the MD5 format. The local-user database must be downgraded prior to reverting to StarOS releases prior to 20.0.

To downgrade the local-user database to use the MD5 hash algorithm, a Security Administrator must run the Exec mode **downgrade local-user database** command. StarOS prompts for confirmation and requests the Security Administrator to reenter a password. The entered password re-authenticates the user prior to executing the downgrade command. After verification, the password is hashed using the appropriate old/weak encryption algorithm and saved in the database to allow earlier versions of StarOS to authenticate the Security Administrator.

The downgrade process does not convert PBKDF2 hashed passwords to MD5 format. The downgrade process re-reads the database (from the /flash directory), reconstructs the database in the older format, and writes it back to the disk. Since the PBKDF2 hashed passwords cannot be converted to the MD5 hash algorithm, and earlier StarOS releases cannot parse the PBKDF2 encryption algorithm, StarOS suspends all those users encrypted via the PBKDF2 algorithm. Users encrypted via the MD5 algorithm ("Weak Hash" flag) can continue to login with their credentials. After the system comes up with the earlier StarOS release, suspended users can be identified in the output of the **show local-user [verbose]** command.

To reactivate suspended users a Security Administrator can:

- Set temporary passwords for suspended users, using the Exec mode **password change local-user *username*** command.



- Reset the suspend flag for users, using the Configuration mode **no suspend local-user** *username* command.

## Provisioning Lawful Intercept

Lawful Intercept (LI) functionality allows a network operator to intercept control and data messages to and from targeted mobile users. Accompanied by a court order or warrant, a Law Enforcement Agency (LEA) initiates a request for the network operator to start the interception for a particular mobile user.

There are different standards followed for Lawful Intercept in different countries. The *LI Configuration Guide* describes how the feature works as well as how to configure and monitor the feature for each of the StarOS services that support Lawful Intercept. This guide is not available on [www.cisco.com](http://www.cisco.com). It can only be obtained by contacting your Cisco account representative.

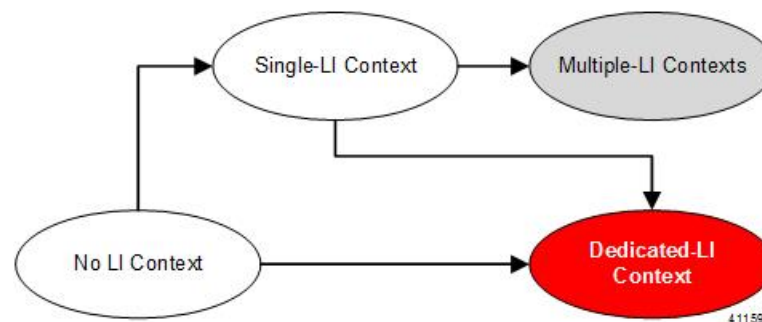
Security-related limitations on Lawful Intercept provisioning are described in *Lawful Intercept Restrictions* section of the *System Security* chapter.

LI can be provisioned within one or more StarOS contexts. An administrative user with **li-administration** privilege is associated with the context(s) that support LI capability. That administrator has access to the CLI configuration commands that provision LI functionality.

There are several types of LI configurations supported within a StarOS system configuration.

- **No LI Context** – The LI configuration was never entered for any context.
- **Single LI Context** – The LI configuration was entered within one context, but was never been entered within any other context. In this state, the Single LI Context can be converted to Multiple LI contexts if another context is configured with an LI configuration, or this context can be converted into the Dedicated-LI context by entering the Context Configuration mode **dedicated-li** command.
- **Multiple LI Contexts** – Two or more contexts have been configured with the LI configuration. A Multiple-LI context configuration can never be re-configured as any other type of LI configuration.
- **Dedicated LI Context** – If the existing system configuration is a No LI Context or a Single LI Context system, it can be converted to a Dedicated-LI Context system by entering the Context Configuration mode **dedicated-li** command. A Dedicated LI context limits access to the LI configuration to the one VPN context which requires it. Once configured as a Dedicated-LI context system, it can never be re-configured any other type of LI context system. Refer to the *Lawful Intercept Configuration Guide* before attempting to create a Dedicated-LI context.

**Figure 6: LI Context Configurations**



In Release 21.4 and higher (Trusted builds only):

- Users can only access the system through their respective context interface.

- If the user attempts to log in to their respective context through a different context interface, that user will be rejected.
- Irrespective of whether the users are configured in any context with 'authorized-keys' or 'allowusers', with this feature these users will be rejected if they attempt to log in via any other context interface other than their own context interface.
- Users configured in any non-local context are required to specify which context they are trying to log in to. For example:

```
ssh username@ctx_name@ctx_ip_addr
```

## Restricting User Access to a Specified Root Directory

By default an admin user who has FTP/SFTP access can access and modify any files under the /mnt/user/ directory. Access is granted on an "all-or-nothing" basis to the following directories: /flash, /cdrom, /hd-raid, /records, /usb1 and /usb2.

An administrator or configuration administrator can create a list of SFTP subsystems with a file directory and access privilege. When a local user is created, the administrator assigns an SFTP subsystem. If the user's authorization level is not security admin or admin, the user can only access the subsystem with read-only privilege. This directory is used as the user's root directory. The information is set as environmental variables passed to the openssh sftp-server.

You must create the SFTP root directory before associating it with local users, administrators and config administrators. You can create multiple SFTP directories; each directory can be assigned to one or more users.

## Configuring an SFTP root Directory

The **subsystem sftp** command allows the assignment of an SFTP root directory and associated access privilege level.

```
configure
 context local
 server sshd
 subsystem sftp [name sftp_name root-dir pathname mode { read-only
| readwrite }]
```

Notes:

- *sftp\_name* is an alphanumeric string that uniquely identifies this subsystem.
- *pathname* specifies the root directory to which SFTP files can be transferred. Options include:
  - /hd-raid/records/cdr
  - /flash

## Associating an SFTP root Directory with a Local User

The **local-user username** command allows an administrator to associate an SFTP root directory with a specified username.

```
configure
 local-user username user_name authorization-level level ftp sftp-server
```

```
sftp_name password password
exit
```

## Associating an SFTP root Directory with an Administrator

The **administrator** command allows an administrator to associate an SFTP root directory for a specified administrator.

```
configure
context local
administrator user_name password password ftp sftp-server sftp_name
exit
```

## Associating an SFTP root Directory with a Config Administrator

The **config-administrator** command allows an administrator to associate an SFTP root directory with a specified configuration administrator.

```
configure
context local
config-administrator user_name password password ftp sftp-server sftp_name
exit
```

# Configuring TACACS+ for System Administrative Users

This section describes TACACS+ (Terminal Access Controller Access Control System+) AAA (Authentication Authorization and Accounting) service functionality and configuration on the ASR 5500.

## Operation

TACACS+ is a secure, encrypted protocol. By remotely accessing TACACS+ servers that are provisioned with the administrative user account database, the ASR 5500 system can provide TACACS+ AAA services for system administrative users. TACACS+ is an enhanced version of the TACACS protocol that uses TCP instead of UDP.

The system serves as the TACACS+ Network Access Server (NAS). As the NAS the system requests TACACS+ AAA services on behalf of authorized system administrative users. For the authentication to succeed, the TACACS+ server must be in the same local context and network accessed by the system.

The system supports TACACS+ multiple-connection mode. In multiple-connection mode, a separate and private TCP connection to the TACACS+ server is opened and maintained for each session. When the TACACS+ session ends, the connection to the server is terminated.

TACACS+ is a system-wide function on the ASR 5500. TACACS+ AAA service configuration is performed in TACACS Configuration Mode. Enabling the TACACS+ function is performed in the Global Configuration Mode. The system supports the configuration of up to three TACACS+ servers.

Once configured and enabled on the system, TACACS+ authentication is attempted first. By default, if TACACS+ authentication fails, the system then attempts to authenticate the user using non-TACACS+ AAA services, such as RADIUS.

It is possible to configure the maximum number of simultaneous CLI sessions on a per account or per authentication method basis. It will protect certain accounts that may have the ability to impact security

configurations and attributes or could adversely affect the services, stability and performance of the system. The maximum number of simultaneous CLI sessions is configurable when attempting a new TACACS+ user login. The recommendation is to use the max-sessions feature is through the TACACS+ server attribute option **maxsess**. The second way is through the StarOS CLI configuration mode TACACS+ mode using the **maxsess** keyword in the **user-id** command. If the maximum number of sessions is set to 0, then the user is authenticated regardless of the login type. When the CLI task starts, a check is complete to identify the count. In this case, the CLI determines that the sessions for that user is 1 which is greater than 0 and it will display an error message in the output, it generate starCLIActiveCount and starCLIMaxCount SNMP MIB Objects and starGlobalCLISessionsLimit and starUserCLISessionsLimit SNMP MIB Alarms.

The **max-sessions** *TACACS+ Configuration Mode command* configures the maximum number of sessions available for TACACS+. Also the **default** option for the **user-id** *TACACS+ Configuration Mode command* configures the default attributes for a specific TACACS+ user identifier. Refer to the *Command Line Interface Reference* for detailed information about these commands.



**Important** The user can define the maximum number of simulations CLI sessions available in both the StarOS and TACACS+ server configuration. However, this option is extremely discouraged.

---



**Important** For releases after 15.0 MR4, TACACS+ accounting (CLI event logging) will not be generated for Lawful Intercept users with privilege level set to 15 and 13.

---

## User Account Requirements

Before configuring TACACS+ AAA services, note the following TACACS+ server and StarOS user account provisioning requirements.

### TACACS+ User Account Requirements

The TACACS+ server must be provisioned with the following TACACS+ user account information:

- A list of known administrative users.
- The plain-text or encrypted password for each user.
- The name of the group to which each user belongs.
- A list of user groups.
- TACACS+ privilege levels and commands that are allowed/denied for each group.



**Important** TACACS+ privilege levels are stored as Attribute Value Pairs (AVPs) in the network's TACACS+ server database. Users are restricted to the set of commands associated with their privilege level. A mapping of TACACS+ privilege levels to StarOS CLI administrative roles and responsibilities is provided in the table below.

---

To display the default mapping of TACACS+ privilege levels to CLI administrative roles, run the Exec mode **show tacacs priv-lvl** command. The default mapping varies based on the StarOS release and build type.

TACACS+ priv-levels can be reconfigured from their default StarOS authorization values via the TACACS+ Configuration mode **priv-lvl** and **user-id** commands. For additional information, see the *TACACS+ Configuration Mode Commands* chapter of the *Command Line Interface Reference*.



---

**Important** In release 20.0 and higher Trusted StarOS builds, FTP is not supported.

---

## StarOS User Account Requirements

TACACS+ users who are allowed administrative access to the system must have the following user account information defined in StarOS:

- username
- password
- administrative role and privileges



---

**Important** For instructions on defining users and administrative privileges on the system, refer to *Configuring System Administrative Users*.

---

## Configuring TACACS+ AAA Services

This section provides an example of how to configure TACACS+ AAA services for administrative users on the system.



---

**Caution** When configuring TACACS+ AAA services for the first time, the administrative user must use non-TACACS+ services to log into the StarOS. Failure to do so will result in the TACACS+ user being denied access to the system.

---

Log in to the system using non-TACACS+ services.

Use the example below to configure TACACS+ AAA services on the system:

```
configure
tacacs mode
server priority priority_number ip-address tacacs+svr_ip_address
end
```

Note:

- **server priority** *priority\_number*: Must be an integer from 1 to 3 (*releases prior to 18.2*) or 1 through 4 (*releases 18.2+*), that specifies the order in which this TACACS+ server will be tried for TACACS+ authentication. 1 is the highest priority, and 3 or 4 is the lowest. The priority number corresponds to a configured TACACS+ server.
- **ip-address**: Must be the IPv4 address of a valid TACACS+ server that will be used for authenticating administrative users accessing this system via TACACS+ AAA services.

- By default, the TACACS+ configuration will provide authentication, authorization, and accounting services.

Enable TACACS+ on the StarOS:

```
configure
 aaa tacacs+
 end
```

For additional information, see [Disable TACACS+ Authentication for Console, on page 67](#).

Save the configuration as described in the *Verifying and Saving Your Configuration* chapter.



#### Important

For complete information on all TACACS+ Configuration Mode commands and options, refer to the *TACACS Configuration Mode Commands* chapter in the *Command Line Reference*.

## Configuring TACACS+ for Non-local VPN Authentication

By default TACACS+ authentication is associated with login to the local context. TACACS+ authentication can also be configured for non-local context VPN logins. TACACS+ must be configured and enabled with the option described below.

A **stop** keyword option is available for the TACACS+ Configuration mode **on-unknown-user** command. If TACACS+ is enabled with the command-keyword option, the VPN context name into which the user is attempting a login must match the VPN name specified in the username string. If the context name does not match, the login fails and exits out.

Without this option the login sequence will attempt to authenticate in another context via an alternative login method. For example, without the **on-unknown-user stop** configuration, an admin account could log into the local context via the non-local VPN context. However, with the **on-unknown-user stop** configuration, the local context login would not be attempted and the admin account login authentication would fail.

```
configure
 tacacs mode
 on-unknown-user stop ?
 end
```

## Verifying the TACACS+ Configuration

This section describes how to verify the TACACS+ configuration.

Log out of the system CLI, then log back in using TACACS+ services.



#### Important

Once TACACS+ AAA services are configured and enabled on the StarOS, the system first will try to authenticate the administrative user via TACACS+ AAA services. By default, if TACACS+ authentication fails, the system then continues with authentication using non-TACACS+ AAA services.

At the Exec Mode prompt, enter the following command:

```
show tacacs [client | priv-lvl | session | summary]
```

The output of the **show tacacs** commands provides summary information for each active TACACS+ session such as username, login time, login status, current session state and privilege level. Optional filter keywords provide additional information.

An example of this command's output is provided below. In this example, a system administrative user named *asradmin* has successfully logged in to the system via TACACS+ AAA services.

```
active session #1:
 login username : asradmin
 login tty : /dev/pts/1
 time of login : Fri Oct 22 13:19:11 2011
 login server priority : 1
 current login status : pass
 current session state : user login complete
 current privilege level : 15
 remote client application : ssh
 remote client ip address : 111.11.11.11
 last server reply status : -1
total TACACS+ sessions : 1
```



---

**Important** For details on all TACACS+ maintenance commands, refer to the *Command Line Interface Reference*.

---

## IPv6 Address Support for TACACS+ Server

### Separating Authentication Methods

You can configure separate authentication methods for accessing the Console port and establishing SSH/telnet sessions (vty lines).

If you configure TACACS+ globally, access to the Console and vty lines are both authenticated using that method.

Since the Console port is a last resort access to StarOS, you can configure local authentication for the Console and employ TACACS+ for the vty lines.



---

**Important** This feature extends to AAA (Authentication, Authorization and Accounting) service as well as local users. For example, local-users may have only Console access and AAA (VPN context) users with access only via vty lines.

---

Separating authentication methods (Console versus vty lines) requires disabling Console access for users based on the type of authentication.

### Disable TACACS+ Authentication for Console

A **noconsole** keyword for the Global Configuration mode **aaa tacacs+** command disables TACACS+ authentication on the Console line.

```
configure
 aaa tacacs+ noconsole
 exit
```

By default, TACACS+ server authentication is performed for login from a Console or vty line. With **noconsole** enabled, TACACS+ authentication is bypassed in favor of local database authentication for a console line; on vty lines, TACACS+ remains enabled.




---

**Important** When **aaa tacacs+ noconsole** is configured, a local user with valid credentials can log into a Console port even if **on-authen-fail stop** and **on-unknown-user stop** are enabled via the TACACS+ Configuration mode. If the user is not a TACACS+ user, he/she cannot login on a vty line.

---

## Disable AAA-based Authentication for Console

A **noconsole** keyword for the Global Configuration mode **local-user allow-aaa-authentication** command disables AAA-based authentication on the Console line.

```
configure
 local-user allow-aaa-authentication noconsole
 exit
```

Since local-user authentication is always performed before AAA-based authentication and **local-user allow-aaa-authentication noconsole** is enabled, the behavior is the same as if **no local-user allow-aaa-authentication** is configured. There is no impact on vty lines.




---

**Important** This command does not apply for a Trusted build because the local-used database is unavailable.

---

## Disable TACACS+ Authentication at the Context Level

When you enable **aaa tacacs+** in the Global Configuration mode, TACACS+ authentication is automatically applied to all contexts (local and non-local). In some network deployments you may wish to disable TACACS+ services for a specific context(s).

You can use the **no aaa tacacs+** Context Configuration command to disable TACACS+ services within a context.

```
configure
 context ctx_name
 no aaa tacacs+
```

Use the **aaa tacacs+** Context Configuration command to enable TACACS+ services within a context where it has been previously disabled.




---

**Important** AAA TACACS+ services must be enabled in the Global Configuration mode (all contexts) before you can selectively disable the services at the context level. You cannot selectively enable TACACS+ services at the context level when it has not been enabled globally.

---



## Limit local-user Login on Console/vty Lines

As a security administrator when you create a StarOS user you can specify whether that user can login through the Console or vty line. The [ **noconsole** | **novty** ] keywords for the Global Configuration mode **local-user username** command support these options.

```
configure
local-user username <username> [noconsole | novty]
exit
```

The **noconsole** keyword prevents the user from logging into the Console port. The **novty** keyword prevents the user from logging in via an SSH or telnet session. If neither keyword is specified access to both Console and vty lines is allowed.



### Important

Use of the **noconsole** or **novty** keywords is only supported on the new local-user database format. If you have not run **update local-user database**, you should do so before enabling these keywords. Otherwise, **noconsole** and **novty** keywords will not be saved in the local-user database. After a system reboot, all users will still be able to access the Console and vty lines. For additional information, see the [Updating and Downgrading the local-user Database, on page 60](#).



### Important

This command does not apply for a Trusted build because the local-used database is unavailable.

## Limit Console Access for AAA-based Users

AAA-based users normally login through on a vty line. However, you may want to limit a few users to accessing just the Console line. If you do not use the local-user database (or you are running a Trusted build), this needs to be done by limiting access to the Console line for other AAA-based users. Enable the **noconsole** keyword for all levels of admin users that will not have access to the Console line.

The **noconsole** keyword is available for the Context Configuration mode commands shown below.

```
configure
context <ctx_name>
administrator <username> { encrypted | nopassword | password } noconsole

config-administrator <username> { encrypted | nopassword | password }
noconsole
inspector <username> { encrypted | nopassword | password } noconsole
operator <username> { encrypted | nopassword | password } noconsole
exit
```

The **noconsole** keyword disables user access to the Console line. By default **noconsole** is not enabled, thus all AAA-based users can access the Console line.



### Important

The **local-user allow-aaa-authentication noconsole** command takes precedence. In that case, all AAA-based users cannot access the Console line.

## Verify Configuration Changes

You can verify changes made related to the separation of authentication methods via the Exec mode **show configuration** command. After saving the configuration changes, run **show configuration |grep noconsole** and **show configuration |grep novty**. The output of these commands will indicate any changes you have made.

## Configuring a Chassis Key

A chassis key should be configured for each system. This key is used to decrypt encrypted passwords found in configuration files.

### Overview

The chassis key is used to encrypt and decrypt encrypted passwords in the configuration file. If two or more chassis are configured with the same chassis key value, the encrypted passwords can be decrypted by any of the chassis sharing the same chassis key value. As a corollary to this, a given chassis key value will not be able to decrypt passwords that were encrypted with a different chassis key value.

The chassis key is used to generate the chassis ID which is stored in a file and used as the master key for protecting sensitive data (such as passwords and secrets) in configuration files

For release 15.0 and higher, the chassis ID is an SHA256 hash of the chassis key. The chassis key can be set by users through a CLI command or via the Quick Setup Wizard. If the chassis ID does not exist, a local MAC address is used to generate the chassis ID.

For release 19.2 and higher, the user must explicitly set the chassis key through the Quick Setup Wizard or CLI command. If it is not set, a default chassis ID using the local MAC address will not be generated. In the absence of a chassis key (and hence the chassis ID), sensitive data will not appear in a saved configuration file. The chassis ID is the SHA256 hash (encoded in base36 format) of the user entered chassis key plus a 32-byte secure random number. This assures that the chassis key and chassis ID have 32-byte entropy for key security.

If a chassis ID is not available encryption and decryption for sensitive data in configuration files will not work.

## Configuring a New Chassis Key Value

### CLI Commands



#### Important

Only a user with Security Administrator privilege can execute the **chassis key value** and **chassis keycheck** commands.

Use the Exec mode **chassis key value** *key\_string* command to enter a new chassis key.

The *key\_string* is an alphanumeric string of 1 through 16 characters. The chassis key is stored as a one-way encrypted value, much like a password. For this reason, the chassis key value is never displayed in plain-text form.

The Exec mode **chassis keycheck** *key\_string* command generates a one-way encrypted key value based on the entered *key\_string*. The generated encrypted key value is compared against the encrypted key value of the previously entered chassis key value. If the encrypted values match, the command succeeds and keycheck passes. If the comparison fails, a message is displayed indicating that the key check has failed. If the default chassis key (MAC address) is currently being used, this key check will always fail since there will be no chassis key value to compare against.

Use the **chassis keycheck** command to verify whether multiple chassis share the same chassis key value.



### Important

For release 19.2 and higher, in the absence of an existing chassis ID file the **chassis keycheck** command is hidden.

For additional information, refer to the *Exec Mode Commands* chapter in the *Command Line Interface Reference*.

Beginning with Release 15.0, the chassis ID will be generated from the chassis key using a more secure algorithm. The resulting 44-character chassis ID will be stored in the same file.

Release 14 and Release 15 chassis IDs will be in different formats. Release 15 will recognize a Release 14 chassis ID and consider it as valid. Upgrading from 14.x to 15.0 will not require changing the chassis ID or configuration file.

However, if the chassis key is reset in Release 15 through the Quick Setup Wizard or CLI command, a new chassis ID will be generated in Release 15 format (44 instead of 16 characters). Release 14 builds will not recognize the 44-character chassis ID. If the chassis is subsequently downgraded to Release 14, a new 16-character chassis ID will be generated. To accommodate the old key format, you must save the configuration file in pre-v12.2 format before the downgrade. If you attempt to load a v15 configuration file on the downgraded chassis, StarOS will not be able to decrypt the password/secrets stored in the configuration file.

For release 19.2 and higher, in a chassis where the chassis ID file already exists nothing is changed. However, if the chassis ID file is lost in both management cards, all existing configuration files become invalid. Entering a new chassis key that is the same as the original value will not resolve the issue because of the new method used to generate the chassis ID.



### Caution

After setting a new chassis key, you must save the configuration before initiating a reload. See the *Verifying and Saving Your Configuration* chapter.

## Quick Setup Wizard

The Quick Setup Wizard prompts the user to enter a chassis key value. If a chassis key value is not entered a default chassis is generated using the chassis' MAC address (releases prior to 20.0).

For releases 20.0 and higher, if the chassis ID file does not exist, the Quick Setup Wizard prompts the user to enter a chassis key. A default chassis ID is not generated if a chassis key is not entered.

To run the Quick Setup Wizard, execute the Exec mode **setup** command.

```
[local]host_name# setup
1. Do you wish to continue with the Quick Setup Wizard[yes/no]: y
2. Enable basic configuration[yes/no]: y
3. Change chassis key value[yes/no]: y
4. New chassis key value: key_string
```

## Configuring MIO/UMIO/MIO2 Port Redundancy

Port redundancy for MIO cards provides an added level of redundancy that minimizes the impact of network failures that occur external to the system. Examples include switch or router port failures, disconnected or cut cables, or other external faults that cause a link down error.

**Caution**

To ensure that system card and port-level redundancy mechanisms function properly, disable the Spanning Tree protocol on devices connected directly to any system port. Failure to turn off the Spanning Tree protocol may result in failures in the redundancy mechanisms or service outage.

By default, the system provides port-level redundancy when a failure occurs, or you issue the **port switch** command. In this mode, the ports on active and standby MIO/UMIO/MIO2 cards have the same MAC address, but since only one of these ports may be active at any one time there are no conflicts. This eliminates the need to transfer MAC addresses and send gratuitous ARPs in port failover situations. Instead, for Ethernet ports, three Ethernet broadcast packets containing the source MAC address are sent so that the external network equipment (switch, bridge, or other device) can re-learn the information after the topology change. However, if card removal is detected, the system sends out gratuitous ARPs to the network because of the MAC address change that occurred on the specific port.

With port redundancy, if a failover occurs, only the specific port(s) become active. For example; if port 5/1 fails, then port 6/1 becomes active, while all other active ports on the line card in slot 5 remain in the same active state. In port failover situations, use the **show port table** command to check that ports are active on both cards and that both cards are active.

Take care when administratively disabling a port that is one of a redundant pair. A redundant pair comprises both the active and standby ports—for example 5/1 and 6/1. If 5/1 is active, administratively disabling 5/1 through the CLI does not make 6/1 active. It disables both 5/1 and 6/1 because an action on one port has the same effect on both. Refer to *Creating and Configuring Ethernet Interfaces and Ports in System Interface and Port Configuration Procedures*.

With automatic card-level redundancy, there is no port-level redundancy in an MIO/UMIO failover. The standby MIO/UMIO/MIO2 becomes active and all ports on that card become active. The system automatically copies all the MAC addresses and configuration parameters used by the failed MIO/UMIO/MIO2 to its redundant counterpart. The ports on MIOs keep their original MAC addresses, and the system automatically copies the failed MIO/UMIO/MIO2's configuration parameters to its redundant counterpart.

Port redundancy can be configured to be revertive or non-revertive. With revertive redundancy service is returned to the original port when service is restored.

This feature requires specific network topologies to work properly. The network must have redundant switching components or other devices that the system is connected to. The following diagrams show examples of a redundant switching topologies and how the system reacts to various external network device scenarios.

Figure 7: Network Topology Example Using MIO/UMIO Port Redundancy

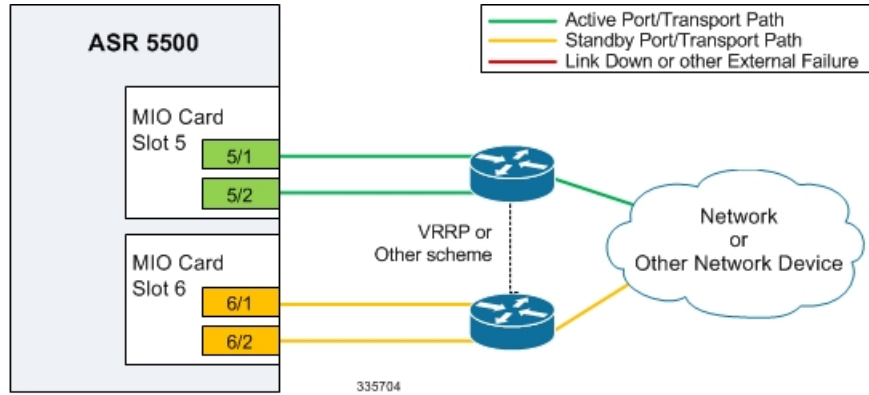
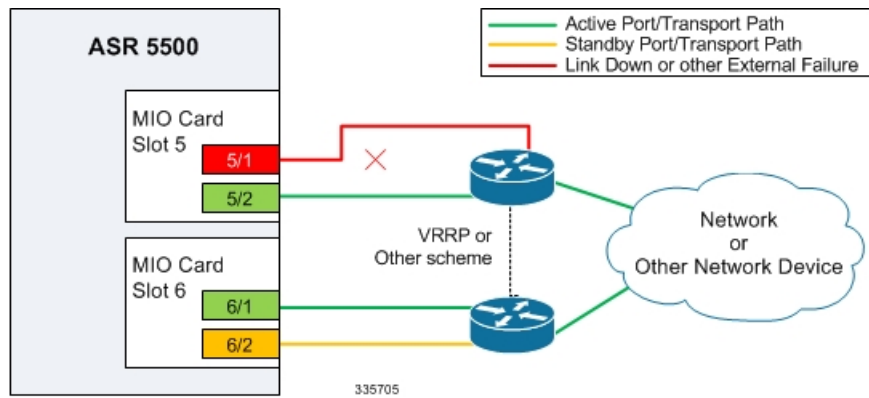
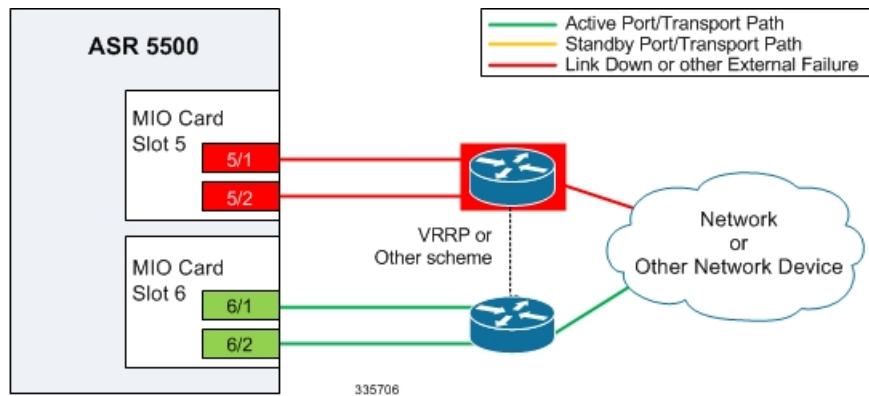


Figure 8: Port Redundancy Failover in Cable Defect Scenario



In the example above, an Ethernet cable is cut or unplugged, causing the link to go down. When this event occurs, the system, with port-mode redundancy enabled, recognizes the link down state and makes port 6/1 the active port. The switching device, using some port redundancy scheme, recognizes the failure and enables the port on the secondary switch to which the MIO/UMIO/MIO2 in slot 6 is connected, allowing it to redirect and transport data.

Figure 9: Port Redundancy Failover in External Network Device Failure Scenario



In the example above, a switch failure causes a link down state on all ports connected to that switch. This failure causes all redundant ports on the line card in slot 6 to move into the active state and utilize the redundant switch.

## Configuring MIO/UMIO/MIO2 Port Redundancy Auto-Recovery

You can configure a port auto-recovery feature. When a port failure occurs and the preferred port is returned to service (link is up), control is automatically returned to that port. By default, ports are in a non-revertive state, meaning that no ports are preferred; a manual port switch is required to return use to the original port.



### Important

This feature is applied on a per port basis (via the **preferred slot** keyword), allowing you to configure specific ports to be used on individual MIO cards. For example, you could configure ports 10 through 19 as preferred on the MIO/UMIO in slot 5, and configure ports 20 through 29 as the preferred ports on the MIO/UMIO in slot 6.

Use the following example to configure a preferred port for revertive, automatic return to service when a problem has cleared:

```
configure
 port ethernet slot#/port#
 preferred slot slot#
 end
```

### Notes

- If you do specify a preference, redundancy is revertive to the specified card. If you do not specify a preference, redundancy is non-revertive.
- Repeat for each additional port that you want to make preferred.

Save the configuration as described in the *Verifying and Saving Your Configuration* chapter.

## Verifying Port Redundancy Auto-Recovery

Verify port information by entering the following command

```
show port info slot#/port#
```

*slot#* is the chassis slot number of the MIO/UMIO/MIO2 card on which the physical port resides.

*port#* is the physical port on the MIO/UMIO/MIO2.

The following shows a sample output of this command for port 1 on the MIO/UMIO/MIO2 in slot 5:

```
[local]host_name# show port info 5/1
Port: 5/1
 Port Type : 1000 Ethernet
 Role : Management Port
 Description : (None Set)
 Redundancy Mode : Port Mode
 Redundant With : 6/1
 Preferred Port : Non-Revertive
 Physical ifIndex : 83951616
 Administrative State : Enabled
 Configured Duplex : Auto
 Configured Speed : Auto
```

```
Configured Flow Control : Enabled
Interface MAC Address : 02-05-47-B8-2F-41
Fixed MAC Address : 02-05-47-B8-2F-41
Link State : Up
Link Duplex : Full
Link Speed : 1000 Mb
Flow Control : Disabled
Link Aggregation Group : None
Logical ifIndex : 83951617
Operational State : Up, Active
```

## Configuring Data Processing Card Availability

As discussed in the *Understanding the System Boot Process* section of *Understanding System Operation and Configuration*, when the system initially boots up, all installed DPC/UDPCs or DPC2/UDPC2s are placed into standby mode. You must activate some of these cards in order to configure and use them for session processing. One DPC/UDPC or DPC2/UDPC2 may remain in standby mode for redundancy.

This section describes how to activate DPC/UDPCs or DPC2/UDPC2s and specify their redundancy.



### Important

Refer to the *ASR 5500 Installation Guide* for information about system hardware configurations and redundancy.

Enter the following command to check the operational status of all DPC types:

```
show card table
```

This command lists the DPC types installed in the system by their slot number, their operational status, and whether or not the card is a single point of failure (SPOF).

Use the following example to configure DPC/UDPC or DPC2/UDPC2 availability:

```
configure
card slot#
 mode { active | standby }
end
```

Notes:

- When activating cards, remember to keep at least one DPC/UDPC or DPC2/UDPC2 in standby mode for redundancy.
- Repeat for every other DPC/UDPC or DPC2/UDPC2 in the chassis that you wish to activate.

Save the configuration as described in the *Verifying and Saving Your Configuration* chapter.

## Verifying Card Configurations

Verify that the configuration was successful. Enter the following command:

```
show card table
```

Any DPC/UDPC or DPC2/UDPC2 that you made active should now have an operational status of *Active*.

## Enabling Automatic Reset of FSC Fabric

By default if an excessive number of discarded fabric egress packets occurred in the switch fabric, a manual reset of the Fabric Storage Card(s) is required for fabric recovery.

You can optionally enable automatic resets of FSCs if an excessive number of discarded fabric egress packets is detected.

A Global Configuration mode **fabric fsc-auto-recover** command enables or disables automatic FSC resets upon detection of an excessive number of discarded fabric egress packets.

The following command sequence enables this feature:

```
configure
 fabric fsc-auto-recovery { disable | enable } [max-attempts [
number_attempts | unlimited]]
end
```

**max-attempts** [ *number\_attempts* | **unlimited** ] specifies how many times StarOS will attempt to reset each FSC as an integer from 1 to 99 or unlimited (will not stop until FSC is reset). The default setting is 1.



### Important

To enable this feature, you must first configure the Fabric Egress Drop Threshold via the Global Configuration mode **fabric egress drop-threshold** command.

## Configuring ASR 5500 Link Aggregation

A Link Aggregation Group (LAG) works by exchanging control packets via Link Aggregation Control Protocol (LACP) over configured physical ports with peers to reach agreement on an aggregation of links as defined in IEEE 802.3ad. The LAG sends and receives the control packets directly on physical ports.

A LAG can have up to 32 member ports, which is 16 ports from MIO/UMIO/MIO2 cards assuming there are two MIO/UMIO/MIO2 cards.

Link aggregation (also called trunking or bonding) provides higher total bandwidth, auto-negotiation, and recovery by combining parallel network links between devices as a single link. A large file is guaranteed to be sent over one of the links, which removes the need to address out-of-order packets.

## LAG and Master Port

Logical port configurations (VLAN and binding) are defined in the master port of the LAG. If the master port is removed because of a card removal/failure, another member port becomes the master port (resulting in VPN binding change and outage), unless there is a redundant master port available.



### Important

The master port on which VLAN can be created for VPN binding must always be configured on the active/master MIO/UMIO/MIO2. The redundancy between the MIO/UMIO/MIO2 in slot 5 and the MIO/UMIO/MIO2 in slot 6 automatically causes both ports to be the master with the same VLANs configured and active.



## LAG and Port Redundancy

ASR 5500 LAG implementation assumes that:

- LAG ports on MIO/UMIO/MIO2-slot 5 and MIO/UMIO/MIO2-slot 6 are connected to two Ethernet switches.
- LAG ports on MIO/UMIO/MIO2-slot 5 and MIO/UMIO/MIO2-slot 6 are both active at the same time.
- Ports on MIO/UMIO/MIO2-slot 5 and MIO/UMIO/MIO2-slot 6 are redundant with each other.

All ports in a LAG can be auto-switched to another MIO/UMIO/MIO2 when certain active port counts or bandwidth thresholds are crossed.

## LAG and Multiple Switches

This feature connects subscriber traffic ports on MIOs to ports on Ethernet switches. A port failure/switch forces all ports in a LAG to switch to the other MIO/UMIO/MIO2 when a specified threshold is crossed. This works in a way similar to the auto-switch feature for port redundancy. LACP runs between the ASR 5500 and the Ethernet switch, exchanging relevant pieces of information, such as health status.

The following table summarizes typical LAG functionality on an MIO/UMIO/MIO2 card.

**Table 4: MIO/UMIO/MIO2 LAG Functionality**

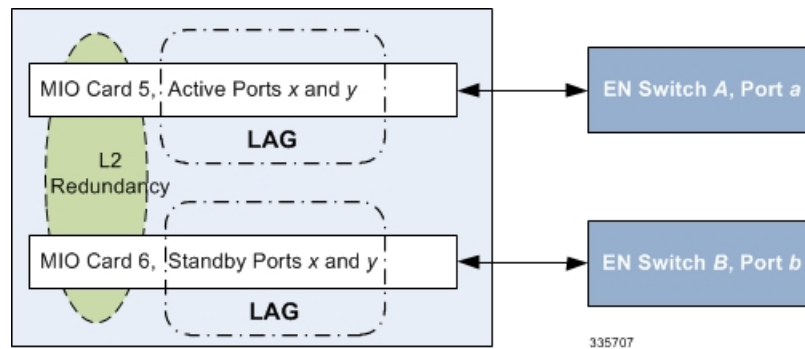
| ASR 5500              | LAGID | Ethernet Switch A | Ethernet Switch B |
|-----------------------|-------|-------------------|-------------------|
| MIO/UMIO/MIO2 Port 11 | 1     | Port 1            | ----              |
| MIO/UMIO/MIO2 Port 12 | 1     | Port 2            | ----              |
| MIO/UMIO/MIO2 Port 13 | 1     | ----              | Port 1            |

## Multiple Switches with L2 Redundancy

To handle the implementation of LACP without requiring standby ports to pass LACP packets, two separate instances of LACP are started on redundant cards. The two LACP instances and port link state are monitored to determine whether to initiate an auto-switch (including automatic L2 port switch).

The figure below shows an LAG established across two MIO/UMIO/MIO2 daughter card ports with L2 redundancy.

Figure 10: LAG with L2 Redundancy, Two Ethernet Switches



An LACP implementation with L2 redundancy cannot pass traffic even though standby ports have link up. For example, with two MIO/UMIO/MIO2 cards connected to two different Ethernet switches and all ports in the same LAG, failure of ports would not trigger a LAG switch until the active port number ratio flipped (more ports down than up).

## Port States for Auto-Switch

Ports are classified in one of four states to determine whether to start auto-switching. See the table below.

For counters, State(x) represents the number of ports on a card in that state.

Table 5: Auto-Switch Port States

| State      | Counter | Description                                               |
|------------|---------|-----------------------------------------------------------|
| Link       | L(x)    | Physical link up                                          |
| Standby    | S(x)    | Link up but in standby mode                               |
| Waiting    | W(x)    | Waiting for Link Aggregation Control Protocol negotiation |
| Aggregated | A(x)    | Aggregation formed                                        |

## Hold Time

Once the LAG manager switches to another LACP instance, it does not consider another change for a short period to let link and LACP negotiation settle down. This "hold time" is configurable.

The LAG manager also enters/extends the hold period when an administrator manually switches ports to trigger a card switch.

## Preferred Slot

You can define which card is preferred per LAG group as a **preferred slot**. When a preferred MIO/UMIO/MIO2 slot is specified, it is selected for the initial timeout period to make the selection of a switch less random.

Port preference is not allowed in this mode.

## Auto-Switch Criteria

The following criteria determine the switching of card  $x$  to card  $y$  to provide better bandwidth while allowing manual intervention. The evaluation of the criteria occurs outside of the hold period.

Ports are automatically switched from card  $x$  to card  $y$  when  $A(y) = 1$ , at least one port is in aggregated state on card  $y$ , and one of the following conditions is true (in order of precedence):

- $L(x) > L(y)$  Less ports with link Up on card  $x$  than card  $y$
- $S(x) > S(y)$  More ports in Standby state on card  $x$  than card  $y$
- $W(x) > W(y)$  More ports in Waiting state on card  $x$  than card  $y$
- $A(x) > A(y)$  Fewer ports in Aggregated state on card  $x$  than card  $y$
- Card  $y$  is preferred
- Card  $y$  is selected.

## Link Aggregation Control

One port in an aggregation group is configured as a master so that all traffic (except control traffic) in the aggregation group logically passes through this port. It is recommended that you configure link-aggregation on the master port first when enabling LAG, and unconfigure the master port last when disabling LAG.

The following command creates link aggregation group  $N$  with port  $slot\#/port\#$  as master. Only one master port is allowed for a group.  $N$  must be in the range of [1–255].

**configure**

```
port ethernet slot#/port#
 link-aggregation master group N
exit
```



### Important

Link Aggregation Control Protocol (LACP) starts running only when the master port is enabled.

Use the following command to add a port as member of link aggregation group number  $N$  only if the master port is assigned. Otherwise, it is added to the group when the master port is assigned:

```
port ethernet slot#/port#
 link-aggregation member group N
exit
```



### Important

The VPN can only bind the master port, and a VLAN can only be created on the master port. A failure message is generated if you attempt to bind to a link aggregation member port.

Each system that participates in link aggregation has a unique system ID that consists of a two-byte priority (where the lowest number [0] has the highest priority) and a six-byte MAC address derived from the first port's MAC address. The following command sets the system priority used to form the system ID.  $P$  is a hex in the range [0x0000..0xFFFF]. The default is 0x8000.

```
card slot#
 link-aggregation system-priority P
```

Ports in a system are assigned keys. The group number maps directly to the key, whereupon only ports with the same key can be aggregated. Ports on each side of the link use a different aggregation key.

The system ID, port key and port ID of two peers form the Link Aggregation Group Identifier (LAGID). You can aggregate links having the same LAGID. Systems are often configured initially with each port in its own aggregation (requiring a separate key per port), or with all ports in the same aggregation (a single key for all ports). Negotiation via LACP would qualify the actual aggregation.

Systems exchange information about system ID, port key and port ID with peers across the physical links using LACP.

LACP packets are defined with the Slow Protocol format. Each system sends out its own ("actor") information and its last received information about its peer ("partner") over the physical link.

Use the following commands to set the LACP parameters. LACP can run in active mode to send LACP packets periodically, or in passive mode, in which it only responds to LACP packets it receives.

LACP can send packets at either a auto (30s) or fast (1s) rate. The defaults for this release are **Active** and **Auto**; see the sample configuration below:

```
config
 port ethernet slot#/port#
 link-aggregation lACP { active | passive } [rate { auto | fast }
 | timeout { long | short }]
```

Peers send out LACP packets when the state changes or if a difference is found from a received LACP packet about its own state.

Corresponding ports on an MIO/UMIO/MIO2 redundant pair cannot be active at the same time. Redundant ports share the same MAC address, so after a failover is resolved, the original port rejoins the link aggregation group.

## Minimum Links

A minimum links option specifies that a Link Aggregation Group (LAG) is up (usable) only when a minimum number of links are available for aggregation. This guarantees that a minimum amount of bandwidth is available for use.

When this feature is enabled, a LAG is not usable when the number of links in a LAG goes below the configured min-link value. Switchover to another LAG bundle (if available) automatically occurs when the number of links in the current active bundle goes below the configured min-link value.

Use the **min-link** keyword option in the Global Configuration mode **link-aggregation** command to enable this feature.

```
configure
 port ethernet slot/port
 link-aggregation master (global | group) number
 min-link number_links
 end
```

## Redundancy Options

For L2 redundancy set the following option on the master port for use with the whole group:

```
link-aggregation redundancy standard [hold-time sec] [preferred slot {
card_number | none }
```

Standard redundancy treats all cards in the group as one group.

## Horizontal Link Aggregation with Two Ethernet Switches

When a LAG contains two sets of ports each connecting to a different switch, the operator has the ability to specify the slot/port (connected to the destination switch) when switching ports.

The Exec mode **link-aggregation port switch to slot/port** command configures this option. The *slot/port* is any valid port connected to the destination switch. The following criteria apply to the setting of this option:

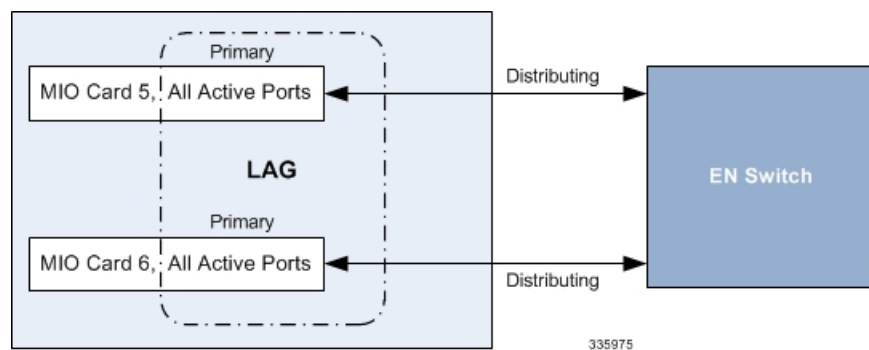
- *slot/port* must support LAG.
- *slot/port* must be configured with LAG.
- *slot/port* must not be already actively distributing
- *slot/port* must have negotiated a link aggregation partner in standard mode.
- *slot/port*'s partner must have an equal or higher in standard mode.
- *slot/port*'s partner bundle must have equal or higher bandwidth in standard mode.
- Switching to *slot/port* must not violate preference within hold-time in standard mode.

## Non-Redundant (Active-Active) LAG

LAG can be deployed in a non-redundant mode in which the ports from both MIO/UMIO/MIO2 cards are connected to the same switch.

As shown in the following figure, all ports in a LAG used on both the cards function in a non-redundant mode (Active/Active).

**Figure 11: Non-Redundant LAG Configuration with Single LAG Group**



In the above configuration, there is a single, primary LAG. All ports work as a single bundle of ports that distribute the traffic.



**Important** If you use the Ethernet Port Configuration mode **shutdown** command to shut down one of the ports on an MIO/UMIO/MIO2 card in this LAG configuration, by default the paired port on the other MIO/UMIO/MIO2 card will also be shut down. You can selectively disable an MIO/UMIO/MIO2 port in this LAG configuration using the Exec mode **port { disable | enable } ethernet slot/port** command.

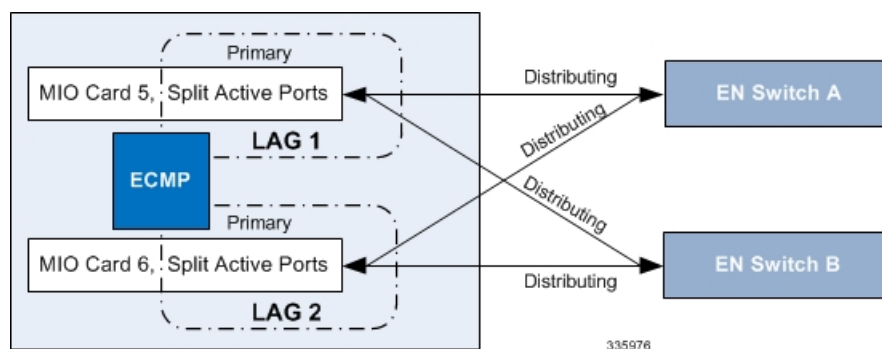


**Important** With this mode of operation, automatic ASR 5500 port redundancy is lost.

To achieve redundancy you must configure a second non-redundant LAG. You can use a higher layer load balancing mechanism such as ECMP (Equal Cost Multiple Path) routing to uniformly distribute the traffic across two LAG groups.

When one MIO/UMIO/MIO2 fails, half the ports from both the LAG groups will be available for distribution of the traffic from the other MIO/UMIO/MIO2.

**Figure 12: Non-Redundant LAG Configuration with ECMP**



Configuring a second LAG group is not mandatory, but is the usual approach for achieving redundancy with this mode of LAG.

However, if the aggregating ports are loaded with more than 50% of their capacity and an MIO/UMIO/MIO2 failure/switchover occurs, the ASR 5500 configured port capacity is oversubscribed and an indeterminate amount of sessions are dropped and traffic lost.

## Faster Data Plane Convergence

The Global Configuration mode **fast-data-plane-convergence** command enables faster recovery of existing sessions in an Active-Active LAG configuration with aggressive MicroBFD timers. This feature can be enabled with an Active-Standby LAG configuration, however, reduced switchover time cannot be guaranteed.

This feature eliminates false positive detection of failure with an external switch and false positive ICSR failover with another ASR 5500.

```
configure
 fast-data-plane-convergence
```

**Important**

Active-Active LAG groups must be configured, along with aggressive microBFD timers (such as 150\*3). During MIO card recovery BGP Sessions might flap based on the configuration. To avoid traffic loss during these events, BGP graceful restart must be configured with proper hold/keepalive and restart timers. See the description of the **bgp graceful-restart** command in the *BGP Configuration Mode Commands* chapter of the *Command Line Interface Reference*.

## Link Aggregation Status

To check the status of link aggregation, use the following commands:

- **show port table**
- **show port info slot/port**

A single character is used to display LAG physical port status in the output of the **show port table** command. See the table below.

**Table 6: LAG Port Status**

| Display     | Description                                                         |
|-------------|---------------------------------------------------------------------|
| LA+         | Port is actively used for distributing (transmit and receive data). |
| LA-         | Port failed to negotiate LACP.                                      |
| LA~ (tilde) | Port negotiated LACP but another peer was selected.                 |
| LA*         | Port is (re)negotiating LACP.                                       |
| LA#         | Port has been gone down because the min-link criteria is not met.   |

## Configuring a Demux Card

You can dedicate a DPC/UDPC or DPC2/UDPC2, or MIO/UMIO/MIO2 to function as a demux card. Demux is a generic term for signal demultiplexing tasks. These tasks are responsible for parsing call setup (signaling packets) and distributing the calls internally. For this reason there almost as many tasks running on a demux card as there are services.

The vpmngr tasks responsible for each context also run on the demux card. The number of vpmngr tasks correspond to the number of contexts. A vpmngr is responsible for IP address assignment to mobile equipment, IP routing (such as BGP, OSPF), as well as a variety of associated tasks.

## Overview

Designating a DPC/UDPC or DPC2/UDPC2, or MIO/UMIO/MIO2 as a demux card frees up resources for session handling, which has the potential to increase system throughput. However, there is no increased support in total subscriber capacity due to other system resource restrictions.

This feature is disabled by default and can be enabled via the Global Configuration mode **require demux** command. It is only supported for a limited number of products. Refer to the product Administration Guide for additional information.

To support this feature session recovery must also be enabled via the Global Configuration mode **require session recovery** command.




---

**Important** After enabling demux card and session recovery, you must save the configuration and reboot the ASR 5500 to enable this feature.

---




---

**Caution** Enabling the Demux on MIO/UMIO/MIO2 feature changes resource allocations within the system. This directly impacts an upgrade or downgrade between StarOS versions in ICSR configurations. Contact Cisco TAC for procedural assistance prior to upgrading or downgrading your ICSR deployment.

---

## MIO Demux Restrictions

The following restrictions apply when enabling an MIO/UMIO/MIO2 as a demux card:

- The **require demux management-card** command must be configured before any service or contexts have been created on the system. The command will not execute after a mode of operation has been selected for the chassis.
- Only the following services currently support the designation of an MIO/UMIO/MIO2 card for demux functions: ePDG (StarOS Release 21.2 and later), GGSN, HeNBGW (StarOS Release 21.2 and later, SaMOG (StarOS Release 21.2 and later), SGW, PGW, HA, SAE-GW and L2TP LNS. These services are supported only when they are deployed as consumer gateways.
- SGSN, MME, HNBN, HeNBGW (StarOS Release 21.1 and earlier), SaMOG (StarOS Release 21.1 and earlier), PDG, PDIF, ePDG (StarOS Release 21.1 and earlier), IPSG, PDSN, HSGW, L2TP LAC, NEMO, FA, and WSG are not supported. Enterprise or corporate gateways (GGSN, HA, PGW, etc.) are also not supported.
- You should not enable demux functionality on MIO/UMIO/MIO2 for configurations that require a large number of tunnels.
- After the ASR 5500 has booted with demux functions running on an MIO/UMIO/MIO2, you cannot configure non-supported services. A maximum of eight Demux Managers are supported. Any attempt to add more than eight Demux Managers will be blocked.
- Service/products requiring a large number of VPN Managers, VRFs and/or Demux Managers must not enable demux functions on an MIO/UMIO/MIO2.
- With demux functions running on an MIO/UMIO/MIO2, the ASR 5500 supports a maximum of 10 contexts, 64 interfaces per context, and 250 VRFs per system.
- ICSR upgrades require compatible configurations and Methods of Procedure (MOPs).

Implementation of this feature assumes that CEPS (Call Events Per Second) and the number of subscribers will remain constant, and only the data rate will increase. This ensures that the CPU demand will not increase on the MIO/UMIO/MIO2.





---

**Note** If a process crash occurs in the background on a demux card, planned or unplanned migration of the card fails.

---



---

**Important** Contact Cisco TAC for additional assistance when assessing the impact to system configurations when enabling the Demux on MIO/UMIO/MIO2 feature.

---

## Configuration

*For releases prior to 15.0*, to configure a DPC/UDPC as a demux card enter the following CLI commands:

```
configure
 require demux card
end
```

*For release 15.0+*, to configure a DPC/UDPC as a demux card enter the following CLI commands:

```
configure
 require demux processing-card
end
```

*For release 18.0+*, to configure a DPC/2UDPC2 as a demux card enter the following CLI commands:

```
configure
 require demux processing-card
end
```

To configure an MIO/UMIO/MIO2 as a demux card enter the following CLI commands:

```
configure
 require demux management-card
end
```





## CHAPTER 4

# Config Mode Lock Mechanisms

This chapter describes how administrative lock mechanisms operate within StarOS configuration mode.

It contains the following sections:

- [Overview of Config Mode Locking, on page 87](#)
- [Requesting an Exclusive-Lock, on page 88](#)
- [Effect of Config Lock on URL Scripts, on page 89](#)
- [Saving a Configuration File, on page 90](#)
- [Reload and Shutdown Commands, on page 90](#)
- [show administrators Command, on page 91](#)

## Overview of Config Mode Locking

You enter the Global Configuration (config) mode via the Exec mode **configure** command. By default all administrative users share config mode. Multiple administrative users can share access to config mode simultaneously. This is called a shared-lock.

The primary indication for the existence of a shared-lock is a message displayed when entering config mode.

```
Warning: One or more other administrators may be configuring this system
```



**Note** There are no default restrictive behavior changes when entering config mode under a shared-lock.

When multiple administrators edit or save the running config, concurrent changes may result in conflicting, inconsistent, or missing configuration commands. A similar problem can occur when saving the configuration if someone is attempting to restart the system.

An optional **lock [ force | warn ]** keyword for the **configure** command allows an administrator to request a mutually exclusive lock of the config mode to assure that no other user is simultaneously modifying the configuration. This is called an exclusive-lock. Once an exclusive-lock is granted to an administrator, no one else can access config mode for the duration of the session while the lock is held. The exclusive-lock is terminated only when the user holding the lock exits to Exec mode.

A shutdown-lock is enabled during a save configuration operation to prevent other users from reloading or shutting down the system while the configuration is being saved.

Config mode locking mechanisms such as shared-lock, exclusive-lock and shutdown-lock mitigate the possibility of conflicting commands, file corruption and reboot issues.

## Requesting an Exclusive-Lock



### Important

To avoid complications resulting from the failure of an administrator holding an exclusive lock to exit config mode, it is a best practice to configure all administrator accounts with CLI session absolute timeouts and/or idle timeouts. For additional information on setting these timeouts, see the *Using the CLI for Initial Configuration* section of the *Getting Started* chapter in this guide.

You can request an exclusive-lock on config mode by executing the Exec mode **configure lock** command.

```
[local]host_name# configure [<url>] lock [force | warn]
```

If you specify a URL, the exclusive lock is associated with the pre-loaded configuration file. If you do not specify a URL, the exclusive lock is granted for the running configuration. For additional information see [Effect of Config Lock on URL Scripts, on page 89](#).

The **force** option forces all other administrators to exit out of configuration mode, including anyone currently holding the exclusive-lock.

The **warn** option warns all other administrators to exit out of configuration mode. This administrator will be taking the exclusive-lock soon. You may want to use this option before actually forcing administrators out of configuration mode,

If there are no other administrators in config mode, entering **configure lock** immediately grants you an exclusive-lock.

```
[local]host_name# configure lock
Info: No one else can access config mode while you have the exclusive lock
[local]host_name#
```

When the exclusive lock is granted, no other administrators are allowed to enter into config mode or load a config file. Any other administrators attempting to enter into config mode or load a config file will see the following message:

```
Failure: User <username> has the exclusive lock
- please enter 'show administrators' for more information
```

If another administrator attempts to enter config mode with the exclusive-lock when it is already enabled, the following message appears:

```
Failure: Another administrator is still in configuration mode
- please enter 'show administrators' for more information
```

If you do not obtain an exclusive lock initially, you can use **configure lock force**.

If **configure lock force** is successful, all users who have been forced to exit to Exec mode will see a warning message indicating that they were forced to exit from config mode:

```
[local]host_name(config)#
Warning: Administrator <username> has forced you to exit from configuration mode
[local]host_name#
```

A **configure lock force** command may not be successful because there is a very small chance that another administrator may be in the middle of entering a password or performing a critical system operation that cannot be interrupted. In this case a failure message will appear:

```
[local]host_name# configure lock force
Failure: Another administrator could not release the configuration mode lock
- please enter 'show administrators' for more information
```

The **configure lock warn** command sends a warning message to all config mode users (if any) and then waits up to 10 seconds to try and acquire the exclusive-lock. If any users are still in config mode, the config mode remains in a shared-lock state.

```
[local]host_name# configure lock warn
please wait for this message to be sent to the other administrators.....
[local]host_name(config)#
```

The other administrators would eventually see this message in their session output:

```
[local]host_name(config)#
Administrator <username> requires exclusive access to configuration mode
>>> You need to exit from configuration mode as soon as possible <<<
[local]host_name#
```

The **configure lock warn** command does not usually result in the exclusive-lock being acquired since the other administrators would typically not anticipate seeing the message in their session output.




---

**Important**

StarOS logs all major config mode lock interactions to the event log and syslog facility (if configured). You can access a record of what interactions transpired at any time.

---

## Effect of Config Lock on URL Scripts

When attempting to load a config script file using the **configure <url>** command, you must acquire either the shared-lock (default) or the exclusive-lock. Since the config script file typically contains the **config** command, the lock is actually held before and after the **config** command is parsed and executed.

The lock is held throughout the execution of the entire config file. Since the same shared-lock is used as the interactive config mode lock, a warning message is displayed followed by a confirmation prompt (if **-noconfirm** is not enabled) as shown in the example below.

```
[local]host_name# config /flash/myconfig.cfg
Warning: One or more other administrators may be configuring this system
Are you sure? [Y/N]:
```

With **-noconfirm** enabled, since all the commands are also echoed to the screen, the warning message will likely scroll off the screen and may not be noticed.




---

**Important**

When StarOS first starts up, the Initial Boot Config File is always exclusively locked while loading.

---

## Saving a Configuration File

Saving a partial or incomplete configuration file can cause StarOS to become unstable when the saved configuration is loaded at a later time. StarOS inhibits the user from saving a configuration which is in the process of being modified.

With a shared-lock in-effect for the duration of the save operation, you are prompted to confirm the save operation.

```
[local]host_name# save configuration /flash/config.cfg
Warning: One or more other administrators may be configuring this system
Are you sure? [Y/N]:
```

If an exclusive-lock is being held by a user, the save operation will fail.

```
[local]host_name# save configuration /flash/config.cfg
Failure: Configuration mode is currently locked, use ignore-lock to ignore lock
```

You can use the **ignore-locks** keyword with the **save configuration** command to override an existing exclusive-lock.

```
[local]host_name# save configuration /flash/config.cfg ignore-locks
Warning: Ignoring the configuration mode lock held by another administrator
```



### Important

The **save configuration** command also enables a shutdown-lock that prevents any other users from reloading or shutting down the system while the configuration is being saved. For additional information, refer to [Reload and Shutdown Commands, on page 90](#).

## Reload and Shutdown Commands

The Exec mode **reload** and **shutdown** commands can result in a corrupted or partial configuration file when either of these commands are executed while a **save configuration** command is still in progress.

To prevent this problem from occurring, the **reload** and **shutdown** commands share a CLI shutdown-lock with all **save configuration** commands executed across StarOS. This means while any **save configuration** command is executing, StarOS cannot execute a **reload** or **shutdown** command. These commands are queued indefinitely until all save configuration operations are complete.

To prevent the user from being “hung” indefinitely in the wait queue, the user may press Control+C to exit the wait as shown in the example below.

```
[local]host_name# reload
Are you sure? [Yes|No]: yes
Waiting for other administrators to finish saving configuration
(ctrl-c to abort)^C
Action aborted by ctrl-c
[local]host_name#
```

On those rare occasions when you must reboot StarOS immediately regardless of the risk of corrupting any file(s) in the process of being saved, you can use the **ignore-locks** keyword in combination with the **reload** or **shutdown** command. With this option StarOS displays the appropriate warning message, but does not wait for save configuration operations to complete before initiating the reboot.

```
[local]host_name# reload ignore-locks -noconfirm
Warning: One or more other administrators are saving configuration
Starting software 21.0...
Broadcast message from root (pts/2) Wed May 11 16:08:16 2016...
The system is going down for reboot NOW !!
```




---

**Caution** Employing the **ignore-locks** keyword when rebooting the system may corrupt the configuration file.

---

## show administrators Command

The Exec mode **show administrators** command has a single-character "M" column that indicates the current lock mode for the administrator's session. The M-mode characters are defined as follows:

- [blank] – Administrator is in Exec mode
- **c** – Administrator session is currently in Config Mode (shared-lock)
- **s** – Administrator session is currently saving the config
- **f** – Administrator session is currently loading the config file
- **L** – Administrator session is currently in Config Mode with the exclusive-lock

The following is sample output of the **show administrators** command indicating current lock mode:

```
[local]asr5500# show administrators
Administrator/Operator Name M Type TTY Start Time

Bob admin /dev/pts/2 Tue Mar 29 11:51:15 2016
Alice c admin /dev/pts/1 Mon Mar 28 14:41:15 2016
Carol admin /dev/pts/0 Mon Mar 28 14:40:52 2016
```







# CHAPTER 5

## Management Settings

This chapter provides instructions for configuring Object Request Broker Element Management (ORBEM) and Simple Network Management Protocol (SNMP) options.

This chapter includes the following sections:

- [ORBEM, on page 93](#)
- [SNMP MIB Browser, on page 95](#)
- [SNMP Support, on page 97](#)

## ORBEM



---

**Important** In StarOS release 21.2 and higher, ORBEM is not supported.

---

The system can be managed by a Common Object Broker Request Architecture (CORBA)-based, Element Management System (EMS).



---

**Important** Commands used in the configuration samples in this section provide base functionality. The most common commands and keyword options are presented. In many cases, other optional commands and keyword options are available. Refer to the *Command Line Interface Reference* for detailed information about all commands.

---

To configure the system to communicate with an EMS:

- 
- Step 1** Set client ID parameters and configure the STOP/TCP port settings by applying the example configuration in [Configuring ORBEM Client and Port Parameters, on page 94](#)
  - Step 2** Configure Internet Inter-ORB Protocol (IIOP) transport parameters by applying the example configuration in [Configuring IIOP Transport Parameters, on page 94](#)
  - Step 3** View your new ORBEM configuration by following the steps in [Verifying ORBEM Parameters, on page 94](#)
  - Step 4** Save the configuration as described in *Verifying and Saving Your Configuration*.
-

## Configuring ORBEM Client and Port Parameters

Use the following example to set client ID parameters and configure the SIOP/TCP port settings:

```
configure
 orbem
 client id encrypted password password
 max-attempt number
 session-timeout time
 siop-port port_number
 event-notif-siop-port siop_notif_port
 event-notif-service
 end
```

Notes:

- You can issue the `client id` command multiple times to configure multiple clients.
- If a client ID is de-activated due to reaching the configured maximum number of attempts, use the **activate client id** command to reactivate it.
- If a firewall exists between the system and the EMS, open the SIOP port number and the TCP port number 15011.
- If the ORB Notification Service is enabled via the **event-notif-service** command, you can set filters to determine which events are to be sent. By default, the Service sends all error and higher level events, "info" level events for the ORBS facility, CLI command logs, and license change logs. Optionally, configure a filter by including the **event-notif-service filter** command. Enter this command for each filter you need to configure.

## Configuring IIOP Transport Parameters

Use the following example to configure Internet Inter-ORB Protocol (IIOP) transport parameters that enable ORB-based management to be performed over the network:

```
configure
 orbem
 iiop-transport
 iiop-port iiop_port_number
 event-notif-iiop-port iiop_notif_port
 end
```

Notes:

- If you are using the Secure Sockets Layer (SSL) option, do not enable the IIOP transport parameter.
- You configure the ORBEM interface to use SSL by specifying a certificate and private key.

## Verifying ORBEM Parameters

- 
- Step 1** Run the **show orbem client table** command to verify that the client was configured properly. This command lists the configured ORBEM clients and displays their state and privileges.

**Step 2** Run the **show orbem status** command to verify the ORBEM parameter configuration. The following displays a sample of this command's output.

```

Service State : On
Management Functions : FCAPS
IOP Address : 192.168.1.150
SSL Port : 14131
TCP Port : 14132
Notification SSL Port : 7777
Notification TCP Port : 7778
Session Timeout : 86400 secs
Max Login Attempts : 5
IIOP Transport : On
Notification : On
Debug Level : Off
IDL Version Check : On
Number of Current Sessions : 1
Number of Event Channels Open : 0
Number of Operations Completed : 2895
Number of Events Processed : 0
Avg Operation Processing time : 87214 usecs
 (last 1000) : 87950 usecs

```

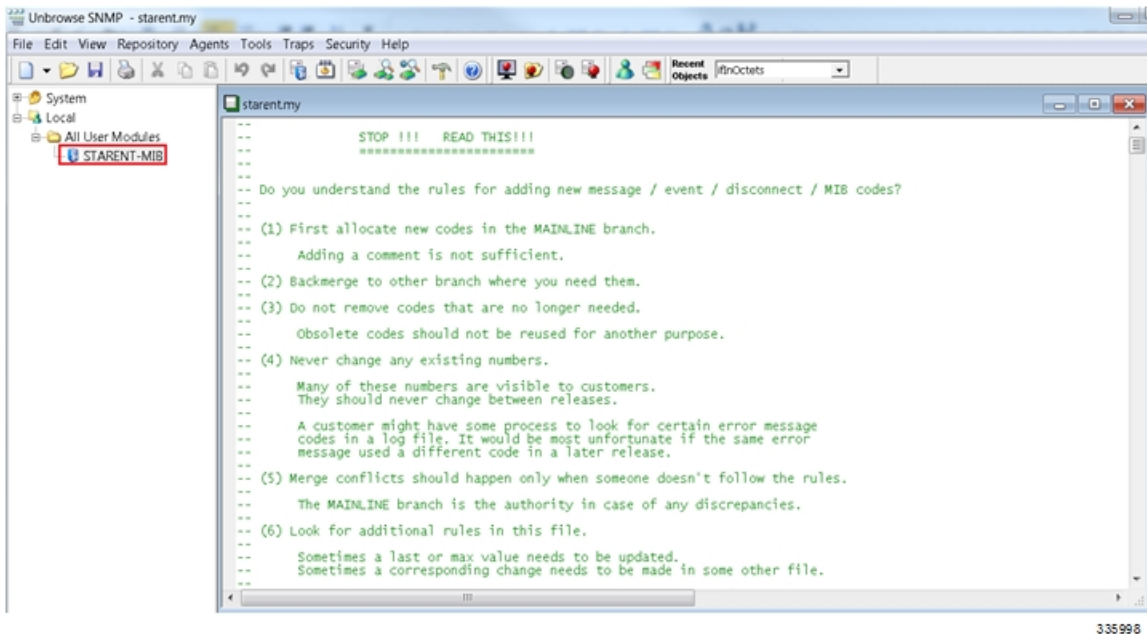
## SNMP MIB Browser

This section provides instructions to access the latest Cisco Starent MIB files using a MIB Browser. An updated MIB file accompanies every StarOS release. For assistance to set up an account and access files, please contact your Cisco sales or service representative for additional information.

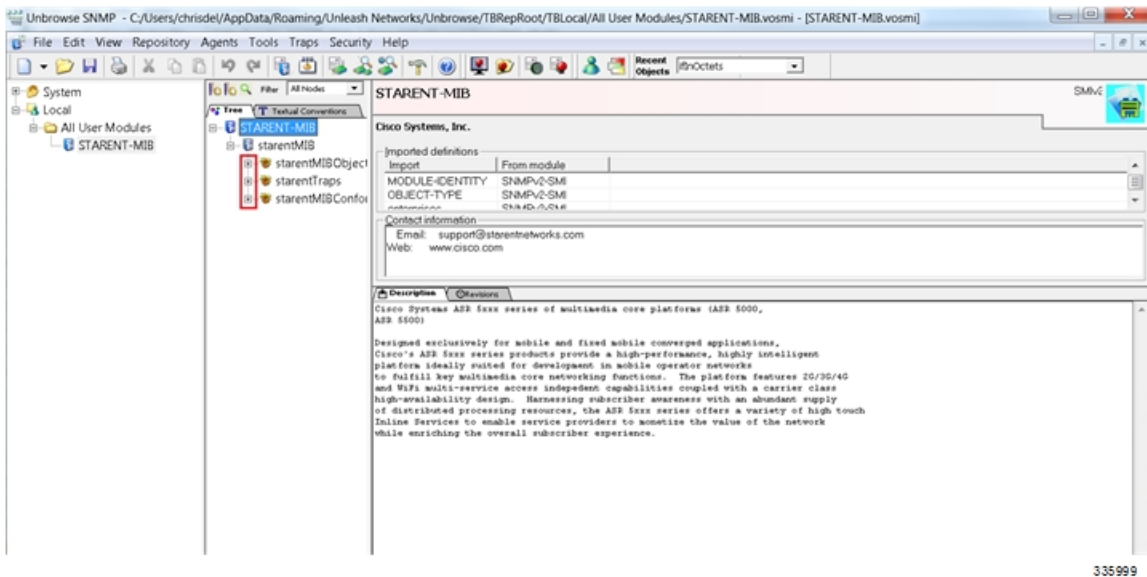
A MIB Browser allows the user to pull out data from SNMP enabled devices. You can load standard and propriety MIBs. The tool allows the user to see the MIB data in a readable format and also offers the ability to search for a specific OID. The Browser displays all of the MIBs in a MIB tree which makes it easy to find and identify all Objects, Traps or Conformances.

Use the following procedure to view the SNMP MIBs for a specific StarOS build :

- 
- Step 1** Contact Cisco sales or a service representative, to obtain access to the MIB files for a specific StarOS release.
  - Step 2** Download the compressed companion file to a folder on your desktop. The file name follows the convention: **companion\_xx.x.x.tgz**
  - Step 3** Open the companion file, unzip it and extract it to the same folder.
  - Step 4** Double click on the new **companion-xx.x.x.xxxxx** file folder.
  - Step 5** Unzip and extract the **companion-xx.x.x.xxxxx.tar** file.
  - Step 6** From your MIB browser, search for and open the **starent.my** file within the .tar file. You can use any SNMP MIB Browser that allows you to compile a MIB **.my** file before viewing it.
  - Step 7** To compile the MIB file, click on the STARENT-MIB file and select **File > Open**.



The STARENT-MIB.vosmi file opens.



In the example below the MIB Browser presents a tree diagram that allows you to display details for each Object, Trap and Conformance. The example below includes the OID number and trap details for the starCardPACMigrateFailed trap.

The screenshot shows the SNMP MIB browser interface. On the left, a tree view displays the hierarchy: System > Local > All User Modules > STARENT-MIB > starentMIB > starentMIBObjects > starentTraps > starCardPACMigrateFailed. The main pane displays details for the MIB entry .1.3.6.1.4.1.8164.2.10, including notification details and a description of the trap.

The SNMP MIB browser allows you to search for specific MIBs. You can search for a specific OID (object identifier) to find a specific MIB entry.

**Important** For information on SNMP MIBs changes for a specific release, refer to the *SNMP MIB Changes in Release xx* chapter of the appropriate version of the *Release Change Reference*.

## SNMP Support

The system uses the SNMP to send traps or events to the EMS server or an alarm server on the network. You must configure SNMP settings to communicate with those devices.



**Important** Commands used in the configuration samples in this section provide base functionality. The most common commands and keyword options are presented. In many cases, other optional commands and keyword options are available. Refer to the *Command Line Interface Reference* for complete information.

The *SNMP MIB Reference* describes the MIBs and SNMP traps supported by the StarOS.

To configure the system to communicate with the EMS server or an alarm server:

- Step 1** Set SNMP parameters such as UDP port, and alarm server target by applying the example configuration in [Configuring SNMP and Alarm Server Parameters, on page 98](#)
- Step 2** To view your new SNMP configuration, follow the steps in [Verifying SNMP Parameters, on page 99](#)

**Step 3** Save the configuration as described in *Verifying and Saving Your Configuration*.

## Configuring SNMP and Alarm Server Parameters

Use the following example to set SNMP and alarm server parameters:

```
configure
 system contact contact_name
 system location location_name
 snmp authentication-failure-trap
 snmp community community_string
 snmp server port port_number
 snmp target name ip_address
 snmp engine-id local id_string
 snmp notif-threshold value low low_value period time_period
 snmp user user_name
 snmp mib mib_name
 snmp runtime-debug [debug-tokens token_id token_id token_id...token_id
end
```

Notes:

- The **system contact** is the name of the person to contact when traps are generated that indicate an error condition.
- An **snmp community** string is a password that allows access to system management information bases (MIBs).
- The system can send SNMPv1, SNMPv2c, or SNMPv3 traps to numerous target devices. However, an EMS may only process SNMP version 1 (SNMPv1) and SNMP version 2c (SNMPv2c) traps. If the SNMP target you are configuring is the EMS application, use the **snmp target** command to configure use of version 1 or version 2c. Issue this command as many times as you need to configure multiple targets. If you configure multiple targets, generated alarms are sent to every configured target.
- The **snmp notif-threshold** command configures the number of SNMP notifications that need to be generated for a given event and the number of seconds in the monitoring window size (default = 300), before the notification is propagated to the SNMP users (default = 300).
- The **snmp engine-id local** command is optional. It is only required if your network requires SNMP v3 support. The engine ID uniquely identifies the SNMP engine and associated SNMP entities, thus providing a security association between the two for the sending and receiving of data.
- The **snmp user** name is for SNMP v3 and is optional. There are numerous keyword options associated with this command.
- Use the **snmp mib** command to enable other industry standard and Cisco MIBs. By default only the STARENT-MIB is enabled.
- By default SNMP runtime debugging always runs and consumes CPU cycles for event logging. To control CPU usage you can set **no snmp runtime-debug** to disable runtime debugging. An option to this command allows you to specify SNMP token values that will locate and parse specified MIBs.



**Important** SNMPv3 traps may not be supported by some EMS applications.

## Verifying SNMP Parameters

**Step 1** Run the **show snmp server** command to verify that the SNMP server information is correctly configured. The following displays a sample output of this command.

```
SNMP Server Configuration:
 Server State : enabled
 SNMP Port : 161
 sysLocation : chicago
 sysContact : admin
 authenticationFail traps : Enabled
 EngineID : 123456789
 Alert Threshold : 100 alerts in 300 seconds
 Alert Low Threshold : 20 alerts in 300 seconds
SNMP Agent Mib Configuration:
 STARENT-MIB : Enabled
 IF-MIB : Disabled
 ENTITY-MIB : Disabled
 ENTITY-STATE-MIB : Disabled
 ENTITY-SENSORE-MIB : Disabled
 HOST-RESOURCES-MIB : Disabled
 CISCO-MOBILE-WIRELESS-SERVICE-MIB : Disabled
 CISCO-ENTITY-DISPLAY-MIB : Disabled
 CISCO-PROCESS-MIB : Disabled
 CISCO-ENTITY-FRU-CONTROL-MIB : Disabled
```

**Step 2** Verify that the SNMP community(ies) were configured properly by entering the following command:

```
show snmp communities
```

The output of this command lists the configured SNMP communities and their corresponding access levels.

**Step 3** Verify that the SNMP transports are configured properly by entering the following command:

```
show snmp transports
```

The following displays a sample output:

```
Target Name: rms1
IP Address: 192.168.1.200
Port: 162
Default: Default
Security Name: public
Version: 1
Security:
View:
Notif Type: traps
```

## Controlling SNMP Trap Generation

The system uses SNMP traps (notifications) to indicate that certain events have occurred. By default, the system enables the generation of all traps. However, you can disable individual traps to allow only traps of a certain type or alarm level to be generated. This section provides instructions for disabling/enabling SNMP traps.



---

**Important**

Commands used in the configuration samples in this section provide base functionality. The most common commands and keyword options are presented. In many cases, other optional commands and keyword options are available. Refer to the *Command Line Interface Reference* for complete information regarding all commands.

---

To configure SNMP trap generation:

---

**Step 1** Set parameters by applying the following example configuration:

```
configure
 snmp trap suppress
 snmp trap suppress trap_name1 trap_name2 ... trap_nameN
```

If at a later time you wish to re-enable a trap that was previously suppressed, use the **snmp trap enable** command.

**Step 2** Save the configuration as described in *Verifying and Saving Your Configuration*.

---





## CHAPTER 6

# Verifying and Saving Your Configuration

This chapter describes how to save your system configuration.

- [Verifying the Configuration, on page 101](#)
- [Synchronizing File Systems, on page 103](#)
- [Saving the Configuration, on page 103](#)

## Verifying the Configuration

You can use a number of commands to verify the configuration of your feature, service, or system. Many are hierarchical in their implementation and some are specific to portions of or specific lines in the configuration file.

## Feature Configuration

In many configurations, you have to set and verify specific features. An example includes IP address pool configuration. Using the example below, enter the listed commands to verify proper feature configuration.

Enter the **show ip pool** command to display the IP address pool configuration. The output from this command should look similar to the sample shown below. In this example, all IP pools were configured in the *isp1* context.

```
context : isp1:
+-----Type: (P) - Public (R) - Private
| (S) - Static (E) - Resource
|
|+-----State: (G) - Good (D) - Pending Delete (R) -Resizing
||
||+---Priority: 0..10 (Highest (0) .. Lowest (10))
||||
||||+--Busyout: (B) - Busyout configured
|||||
vvvvvv Pool Name Start Address Mask/End Address Used Avail

PG00 ipsec 12.12.12.0 255.255.255.0 0 254
PG00 pool1 10.10.0.0 255.255.0.0 0 65534
SG00 vpnpool 192.168.1.250 92.168.1.254 0 5

Total Pool Count: 5
```



**Important** To configure features on the system, use the **show** commands specifically for these features. Refer to the *Exec Mode show Commands* chapter in the *Command Line Interface Reference* for complete information.

## Service Configuration

Verify that your service was created and configured properly by entering the following command:

```
show service_type service_name
```

The output is a concise listing of the service parameter settings similar to the sample displayed below. In this example, a P-GW service called *pgw* is configured.

```
Service name : pgw1
Service-Id : 1
Context : test1
Status : STARTED
Restart Counter : 8
EGTP Service : egtpl
LMA Service : Not defined
Session-Delete-Delay Timer : Enabled
Session-Delete-Delay timeout : 10000 (msecs)
PLMN ID List : MCC: 100, MNC: 99
Newcall Policy : None
```

## Context Configuration

Verify that your context was created and configured properly by entering the **show context name name** command.

The output shows the active context. Its ID is similar to the sample displayed below. In this example, a context named *test1* is configured.

```
Context Name ContextID State

test1 2 Active
```

## System Configuration

Verify that your entire configuration file was created and configured properly by entering the **show configuration** command.

This command displays the entire configuration including the context and service configurations defined above.

## Finding Configuration Errors

Identify errors in your configuration file by entering the **show configuration errors** command.

This command displays errors it finds within the configuration. For example, if you have created a service named "service1", but entered it as "srv1" in another part of the configuration, the system displays this error.

You must refine this command to specify particular sections of the configuration. Add the **section** keyword and choose a section from the help menu as shown in the examples below.

```
show configuration errors section ggsn-service
```

or

```
show configuration errors section aaa-config
```

If the configuration contains no errors, an output similar to the following is displayed:

```
#####
Displaying Global
AAA-configuration errors
#####
Total 0 error(s) in this section !
```

## Synchronizing File Systems

Whenever changes are made to a configuration or StarOS version boot order in a system with redundant management cards, the file systems must be synchronized across the management cards. This assures that the changes are identically maintained across the management cards.

Enter the following Exec mode command to synchronize the local file systems:

```
[local]host_name# filesystem synchronize all
```

The **filesystem** command supports multiple keywords that allow you to check for and repair file system corruption, as well as synchronize a file system with a specific storage device. For additional information, see the *Exec Mode Commands* chapter in the *Command Line Interface Reference*.

## Saving the Configuration

These instructions assume that you are at the root prompt for the Exec mode:

```
[local]host_name#
```

To save your current configuration, enter the following command:

```
save configuration url [obsolete-encryption | showsecrets | verbose] [
-redundant] [-noconfirm]
```

*url* specifies the location in which to store the configuration file. It may refer to a local or a remote file.



### Important

Do not use the "/" (forward slash), ":" (colon) or "@" (at sign) characters when entering a string for the following URL fields: directory, filename, username, password, host or port#.



### Important

The **-redundant** keyword is only applicable when saving a configuration file to a local device (usb1 or usb2) that is installed on both MIO/UMIO/MIO2 cards. This command does not synchronize the local file system. If you have added, modified, or deleted other files or directories to or from a local device for the active MIO/UMIO/MIO2, you must synchronize the local file system on both MIO/UMIO/MIO2s. See [Synchronizing File Systems, on page 103](#).

**Important**

The **obsolete-encryption** and **showsecrets** keywords have been removed from the **save configuration** command in StarOS 19.2 and higher. If you run a script or configuration that contains the removed keyword, a warning message is generated.

For complete information about the above command, see the *Exec Mode Commands* chapter of the *Command Line Interface Reference*.

To save a configuration file called *system.cfg* to a directory that was previously created called *cfgfiles* to the flash memory on the active MIO/UMIO/MIO2, enter the following command:

```
save configuration /flash/cfgfiles/system.cfg
```



## CHAPTER 7

# System Interfaces and Ports

This chapter describes how to create a context and configure system interfaces and ports within the context. Before beginning these procedures, refer to your product-specific administration guide for configuration information for your product.



### Important

Make sure at least one Data Processing Card (DPC/UDPC or DPC2/UDPC2) is active before you configure system interfaces and ports. Refer to *System Settings* in this guide for information and instructions on activating DPCs.

- [Contexts, on page 105](#)
- [Ethernet Interfaces and Ports, on page 106](#)
- [VLANs, on page 109](#)

## Contexts

Even though multiple contexts can be configured to perform specific functions, they are all created using the same procedure.

## Creating Contexts



### Important

Commands used in the configuration examples in this section represent the most common or likely commands and/or keyword options. In many cases, other commands and/or keyword options are available. Refer to the *Command Line Interface Reference* for complete information regarding all commands.

To create a context, apply the following example configuration:

```
configure
 context name
end
```

Repeat to configure additional contexts.

## Viewing and Verifying Contexts

**Step 1** Verify that your contexts were successfully created by entering the following command:

```
[local]host_name# show context all
```

The output is a two-column table similar to the example below. This example shows that two contexts were created: one named *source* and one named *destination*.

| Context Name | ContextID | State  |
|--------------|-----------|--------|
| -----        | -----     | ----   |
| local        | 1         | Active |
| source       | 2         | Active |
| destination  | 3         | Active |

The left column lists the contexts that are currently configured. The center column lists the corresponding context ID for each of the configured contexts. The third column lists the current state of the context.

**Step 2** Save your configuration as described in the *Verifying and Saving Your Configuration* chapter.

**Step 3** Now that the context has been created, interfaces and specific functionality can be configured within the context. Proceed to other sections for instructions on configuring specific services and options.

## Ethernet Interfaces and Ports

Regardless of the type of application interface, the procedure to create and configure it consists of the following:

**Step 1** Create an interface and assign an IP address and subnet mask to it by applying the example configuration in [Creating an Interface, on page 106](#).

**Step 2** Assign a physical port for use by the interface and bind the port to the interface by applying the example configuration in [Configuring a Port and Binding It to an Interface, on page 107](#).

**Step 3** Optionally configure a static route for the interface by applying the example configuration in [Configuring a Static Route for an Interface, on page 107](#).

**Step 4** Repeat the above steps for each interface to be configured.

This section provides the minimum instructions for configuring interfaces and ports to allow the system to communicate on the network. Commands that configure additional interface or port properties are described in the *Ethernet Port Configuration Mode Commands* and *Ethernet Interface Configuration Mode Commands* chapters of the *Command Line Interface Reference*.

To ensure that system line card and port-level redundancy mechanisms function properly, the Spanning Tree protocol must be disabled on devices connected directly to any system port. Failure to turn off the Spanning Tree protocol may result in failures in the redundancy mechanisms or service outage.

## Creating an Interface

Use the following example to create a new interface in a context:

```

configure
 context name
 interface name
 { ip | ipv6 } address address subnetmask [secondary]
 end

```

Notes:

- *Optional:* Add the **loopback** keyword option to the **interface name** command, to set the interface type as "loopback" which is always UP and not bound to any physical port.
- *Optional:* Add the **secondary** keyword to the **{ ip | ipv6 } address** command, to assign multiple IP addresses to the interface. IP addresses can be entered using IPv4 dotted-decimal or IPv6 colon-separated-hexadecimal notation.
- *Optional:* In the interface config mode, add the **port-switch-on-L3-fail address** command, to configure the interface for switchover to the port on the redundant line card if connectivity to a specified IP address is lost. This IP address can be entered using IPv4 dotted-decimal or IPv6 colon-separated-hexadecimal notation.

## Configuring a Port and Binding It to an Interface

Use the following example configuration to configure and assign a port to an interface:

```

configure
 port ethernet slot#/port#
 description description
 no shutdown
 bind interface interface_name context_name
 end

```

Notes:

- For **port ethernet slot#**, use the actual chassis slot in which the MIO/UMIO/MIO2 card is installed; this could be 5 or 6.
- For **port ethernet port#**, use ports 10 to 19 (DC1) or 20 to 29 (DC2).
- *Optional:* In the Ethernet Port configuration mode, add the preferred **slot slot#** command if you want to specify a port preference.
- Binding associates the port and all of its settings to the named interface.

## Configuring a Static Route for an Interface

Use the following example to configure a static route for an interface:

```

configure
 context name
 { ip | ipv6 } route ip_address netmask next-hop gw_address interface_name
 end

```

Notes:

- *ip\_address* and *netmask* are the IP address and subnet mask of the target network. This IP address can be entered using IPv4 dotted-decimal or IPv6 colon-separated-hexadecimal notation.
- *gw\_address* is the IP address of the default gateway or next-hop route. This IP address can be entered using IPv4 dotted-decimal or IPv6 colon-separated-hexadecimal notation.
- To configure a route to the gateway router, use 0.0.0.0 for the network and mask variables.
- Repeat as needed. Multiple static routes can be configured to the same destination to provide an alternative means of communication in case the preferred route fails.

## Viewing and Verifying Port Configuration

**Step 1** Verify that your interface configuration settings are correct by entering the following commands:

```
[local]host_name# context context_name
[context_name]host_name# show { ip | ipv6 } interface
```

*context\_name* represents the name of the context in which the interface was created. The output from these commands should be similar to the following example.

In this example an interface named *mgmt1* was configured in the local context.

### Example:

In this example an interface named *mgmt1* was configured in the local context.

```
Intf Name: mgmt1
Intf Type: Broadcast
IP State: UP (Bound to 10/11 untagged, ifIndex 285278209)
IP Address: 192.168.100.3 Subnet Mask: 255.255.255.0
Bcast Address: 192.168.100.255 MTU: 1500
Resoln Type: ARP ARP timeout: 3600 secs
Number of Secondary Addresses: 0
Total interface count: 1
```

**Step 2** Verify that your port configuration settings are correct by entering the following command:

```
[context_name]host_name# show configuration port slot#/port#
```

*slot#* is the chassis slot number of the MIO/UMIO/MIO2 on which the physical port resides. *slot#* can be 5 or 6.

This command produces an output similar to that displayed in the following example that shows the configuration for port 11 on the MIO/UMIO/MIO2 installed in chassis slot 5.

### Example:

In this example, the port is bound to an interface called *rp1* configured in a context called *source*.

```
config
 port ethernet 5/11
 description MIO5/11_RP1
 no shutdown
 bind interface rp1 source
 #end
```

**Step 3** Verify that your static route(s) was configured properly by entering the following command:

```
[context_name]host_name# show ip static-route
```



**Example:**

This command produces an output similar to that displayed in the following example that shows a static route to a gateway with an IP address of 192.168.250.1.

| Destination | Nexthop       | Protocol | Prec | Cost | Interface  |
|-------------|---------------|----------|------|------|------------|
| 0.0.0.0/0   | 192.168.250.1 | Static   | 0    | 0    | MI01       |
| 0.0.0.0/0   | 192.168.250.1 | Static   | 0    | 0    | rp1 source |

**Step 4** Save the configuration as described in the *Verifying and Saving Your Configuration* chapter.

## VLANs

Virtual LANs (VLANs) allow two logically separated networks to use the same physical medium. VLAN segmentation, also called 802.1q tagging, works by appending a tag identifying the VLAN ID to each Ethernet frame.

For information on how to create VLANs to handle specific packet types, see the *VLANs* chapter.

## Hypervisors

VLAN usage under KVM is an extension to bridge interface sharing. The difference lies in which interface participates in the bridge set. The physical interfaces (such as eth0, eth1) are bound to the bridge, which is used by each guest. These interfaces carry unmodified packets coming externally or being generated internally, with or without a VLAN ID tag.

VMware supports the use of virtual switches that allow virtual machines on one vSphere host to communicate with each other using the same protocols as physical switches. The vSwitch emulates a traditional physical Ethernet network switch by forwarding frames at the data-link layer. A vSphere host can have numerous virtual switches, each with more than 1,000 internal virtual ports for virtual machines. The vSphere platform supports the vSphere Standard Switch virtual switch configuration at the host level and the vSphere Distributed Switch, a single virtual switch that spans multiple associated hosts.

## VLANs and Management Ports

The management interface supports VLAN configuration. This support extends to the local context.

Bulkstats can be sent out an interface other than the normal management interface. This interface also supports VLANs.

You can also configure other OA&M services on separate VLANs.

You can assign separate source IP addresses for the OA&M services. OA&M services should not be bound to the same VLAN as service VLANs. Other services include SGi, Gi, Pi, eGTP or other packet core-specific interfaces and services.

This feature is implemented by adding support for the `vlan` command to the management port in the local context. See the example command sequence below.

```
configure
 port ethernet 1/1
 vlan 184
```

```
no shutdown
bind interface 19/3-UHA foo
```



## CHAPTER 8

# System Security

---

This chapter describes the StarOS security features.

This chapter explores the following topics:

- [Per-Chassis Key Identifier, on page 111](#)
- [Protection of Passwords, on page 112](#)
- [Support for ICSR Configurations, on page 114](#)
- [Encrypted SNMP Community Strings, on page 114](#)
- [Enhanced Password Security, on page 114](#)
- [Lawful Intercept Restrictions, on page 114](#)
- [Adding, Modifying and Removing Users, on page 115](#)
- [Test-Commands, on page 116](#)

## Per-Chassis Key Identifier

A user can set a unique chassis key which will work only for a chassis or for any set of chassis that will share the same configuration information.

The chassis key consists of 1 to 16 alphanumeric ASCII characters. The chassis key plain-text value is never displayed to the user; it is entered interactively and not echoed to the user.

On the ASR5500 the encrypted chassis key is stored in the midplane EEPROM and shared by both MIO/UMIO/MIO2s.

If the chassis key identifier stored in the header comment line of the configuration file does not match the chassis key, an error message is displayed to the user. The user can change the chassis key value simply by entering the chassis key again. The previous chassis key is replaced by a new chassis key. The user is not required to enter a chassis key.

If the user does not configure a chassis key, the system generates a unique value for that chassis.



---

### Important

Changing a chassis key may invalidate previously generated configurations. This is because any secret portions of the earlier generated configuration will have used a different encryption key. For this reason the configuration needs to be recreated and restored.

---

**Important**

To make password configuration easier for administrators, the chassis key should be set during the initial chassis set-up.

The configuration file contains a one-way encrypted value of the chassis key (the chassis key identifier) and the version number in a comment header line. These two pieces of data determine if the encrypted passwords stored within the configuration will be properly decrypted.

While a configuration file is being loaded, the chassis key used to generate the configuration is compared with the stored chassis key. If they do not match the configuration is not loaded.

The user can remove the chassis key identifier value and the version number header from the configuration file. Also, the user may elect to create a configuration file manually. In both of these cases, the system will assume that the same chassis key will be used to encrypt the encrypted passwords. If this is not the case, the passwords will not be decrypted due to resulting non-printable characters or memory size checks. This situation is only recoverable by setting the chassis key back to the previous value, editing the configuration to have the encrypted values which match the current chassis key, or by moving the configuration header line lower in the configuration file.

Beginning with Release 15.0, the chassis ID will be generated from an input chassis key using the SHA2-256 algorithm followed by base36 encoding. The resulting 44-character chassis ID will be stored in the same chassisid file in flash.

Release 14 and Release 15 chassis IDs will be in different formats. Release 15 will recognize a Release 14 chassis ID and consider it as valid. Upgrading from 14.x to 15.0 will not require changing the chassis ID or configuration file

However, if the chassis-key is reset in Release 15 through the setup wizard or **chassis-key** CLI command, a new chassis ID will be generated in Release 15 format (44 instead of 16 characters). Release14 builds will not recognize the 44-character chassis ID. If the chassis is subsequently downgraded to Release 14, a new 16-character chassis ID will be generated. To accommodate the old key format, you must save the configuration file in pre-v12.2 format before the downgrade. If you attempt to load a v15 configuration file on the downgraded chassis, StarOS will not be able to decrypt the password/secrets stored in the configuration file.

## MIO Synchronization

On boot up both MIO/UMIO/MIO2s automatically read the chassis key configured on the ASR 5500 midplane.

## Protection of Passwords

Users with privilege levels of Inspector and Operator cannot display decrypted passwords in the configuration file via the command line interface (CLI).

## Secure Password Encryption

By default for StarOS releases prior to 21.0 the system encrypts passwords using an MD5-based cipher (option A). These passwords also have a random 64-bit (8-byte) salt added to the password. The chassis key is used as the encryption key.

Setting a chassis key supports an encryption method where the decryption requires the knowledge of a "shared secret". Only a chassis with knowledge of this shared secret can access the passwords. To decipher passwords, a hacker who knew the chassis key would still need to identify the location of the 64-bit random salt value within the encryption.

Passwords encrypted with MD-5 will have "+A" prefixes in the configuration file to identify the methodology used for encrypting.

**Important**

For release 21.0 and higher, the default is Algorithm B.

For release 15.0 and higher, another type of encryption algorithm can be specified. The Global Configuration mode **cli-encrypt-algorithm** command allows an operator to configure the password/secret encryption algorithm. The default encryption/password algorithm for releases prior to 21.0 is MD-5 as described above (option A). A second password encryption algorithm (option B) uses AES-CTR-128 for encryption and HMAC-SHA1 for authentication. The encryption key protects the confidentiality of passwords, while the authentication key protects their integrity. For release 21.0 and higher Algorithm B is the default. Passwords encrypted with this key will have "+B" prefixes in the configuration file.

For release 19.2 and higher, a third type of encryption algorithm can be specified (option C). This algorithm specifies the use of the HMAC-SHA512 cipher algorithm for encryption and authentication. Passwords encrypted with this key will have "+C" prefixes in the configuration file.

Also for release 19.2 and higher, the encryption key is hashed from the chassis ID and a 16-byte Initialization Vector (IV) obtained from an internal random number generator. No two passwords are encrypted using the same encryption key/IV pair. The Security Administrator must set a chassis key in order to generate the chassis ID and resulting encryption key. A default chassis key based on a local MAC address is no longer supported.

The syntax for the **cli-encrypt-algorithm** command is:

```
config
 cli-encrypt-algorithm { A | B | C }
```

## Support for Non-Current Encryptions and Decryptions

The system supports previously formatted encrypted passwords. The syntax of the encrypted passwords indicates which methodology was used for encryption. If the system does not see a prefix before the encrypted password, the earlier encryption method using a fixed key will be used. If the encrypted password includes the "+A" prefix, the decryption method uses the chassis key and random salt.

If the user saves a new configuration, the generated file will always contain passwords encrypted by the most recent method. The user cannot generate the earlier DES-based encryption values. However, all future StarOS releases will continue to support plain-text password entry for all two-way encryptable passwords

The recommended process for changing the chassis key without causing a "lock-out" state is as follows:

- Load the configuration file of the last good configuration using the previous chassis key.
- Change the chassis key to the new desired value.
- Save the configuration with this new chassis key.

Refer to *Configuring a Chassis Key* in *System Settings* for additional information.

## Support for ICSR Configurations

Inter-Chassis Session Recovery (ICSR) is a redundancy configuration that employs two identically configured ASR 5500 chassis/instances as a redundant pair.

ICSR pairs share the same chassis key. If the ICSR detects that the two chassis/instances have incompatible chassis keys, an error message is logged but the ICSR system will continue to run. Without the matching chassis key, the standby ICSR peer can recover services if the active peer goes out of service; the standby peer will still have access to the passwords in their decrypted form.

ICSR peers use Service Redundancy Protocol (SRP) to periodically check to see if the redundancy configuration matches with either decrypted passwords or DES-based two-way encryption strings. Since the configuration is generated internally to the software, users are not able to access the configuration used to check ICSR compatibility.

## Encrypted SNMP Community Strings

Simple Network Management Protocol (SNMP) uses community strings as passwords for network elements. Although these community strings are sent in clear-text in the SNMP PDUs, the values can be encrypted in the configuration file.

The **snmp community encrypted name** command enables the encryption of SNMP community strings. For additional information, see the *Global Configuration Mode Commands* chapter in the *Command Line Interface Reference*.

## Enhanced Password Security

## Lawful Intercept Restrictions

This section describes some of the security features associated with the provisioning of Lawful Intercept (LI).

### LI Server Addresses

An external authenticating agent (such as RADIUS or Diameter) sends a list of LI server addresses as part of access-accept. For any intercept that was already installed or will be installed for that subscriber, a security check is performed to match the LI server address with any of the LI-addresses that were received from the authenticating agent. Only those addresses that pass this criteria will get the intercepted information for that subscriber.

While configuring a campon trigger, the user will not be required to enter the destination LI server addresses. When a matching call for that campon trigger is detected, a security check is done with the list received from the authentication agent. The LI-related information is only forwarded if a matching address is found.

When an active-only intercept is configured, if a matching call is found, a security check is made for the LI address received from the authentication agent and the intercept configuration will be rejected.

If no information related to LI server addresses is received for that subscriber, LI server addresses will not be restricted.

**Important**

A maximum of five LI server addresses are supported via an authenticating agent.

**Important**

The ability to restrict destination addresses for LI content and event delivery using RADIUS attributes is supported only for PDSN and HA gateways.

## Modifying Intercepts

One LI administrator can access and/or modify the intercepts created by another LI administrator. Whenever an intercept is added, removed or modified, an event log is displayed across LI administrators about the change. An SNMP trap is also generated.

## Adding, Modifying and Removing Users

It is considered uncommon for a user to be added or removed from the system. Likewise, it is considered uncommon for a user's privileges to be modified. However, if the system is compromised, it is common for attackers to add or remove a privileged user, raise their privileges or lower the privileges of others.

As a general rule, lower privileged users should not be allowed to increase their privileges or gain access to sensitive data, such as passwords, which were entered by higher privileged users.

**Important**

The system can only detect changes in users and user attributes, such as privilege level, when these users are configured through the system.

## Notification of Users Being Added or Deleted

Users with low level authorization should not be able to create users with high level authorization. However, if a malicious actor were to be able to create a high level authorized user, they could then delete the other high level authorized users, thereby locking them out of the system.

The following SNMP traps notify an administrator when users are added or removed:

- **starLocalUserAdded** – indicates that a new local user account has been added to the system.
- **starLocalUserRemoved** – indicates that a local user account has been removed from the system.

## Notification of Changes in Privilege Levels

Whenever a user's privilege level is increased or decreased, an SNMP notification will be sent out. A malicious actor may gain access to more privileged commands by somehow promoting their privileges. Once this is

done, they could then "demote" the privileges of all the other users, thereby locking the proper administrators out of the system.

The **starLocalUserPrivilegeChanged** trap indicates that a local user's privilege level has been changed.

## User Access to Operating System Shell

The **starOsShellAccessed** trap indicates that a user has accessed the operating system shell.

## Test-Commands

Users with Security Administrator or Administrator privilege can enable the display of previously hidden test-commands. The CLI test-commands mode displays new command keywords for existing commands, as well as new commands.



### Caution

CLI test-commands are intended for diagnostic use only. Access to these commands is not required during normal system operation. These commands are intended for use by Cisco TAC personnel only. Some of these commands can slow system performance, drop subscribers, and/or render the system inoperable.

## Enabling cli test-commands Mode

To enable access to test-commands, a Security Administrator must log into the Global Configuration mode and enter **cli hidden**.

This command sequence is shown below.

```
[local]host_name# config
[local]host_name(config)# cli hidden
[local]host_name(config)#
```

By default **cli hidden** is disabled.



### Important

Low-level diagnostic and test commands/keywords will now be visible to a user with Administrator or higher privilege. There is no visual indication on the CLI that the test-commands mode has been enabled.

## Enabling Password for Access to CLI-test commands

A Security Administrator can set a plain-text or encrypted password for access to CLI test commands. The *password* value is stored in **/flash** along with the boot configuration information. The **show configuration** and **save configuration** commands will never output this value in plain text.

The Global Configuration mode command **tech-support test-commands [encrypted] password *new\_password* [old-password *old\_password* ]** sets an encrypted or plain-text password for access to CLI test-commands.

This command sequence is shown below.



```
[local]host_name# config
[local]host_name(config)# tech-support test-commands password new_password [
old-password old_password]
[local]host_name(config)#
```

If the new password replaces an existing password, you must enter the old password for the change to be accepted.

If the old password is not entered or does not match the existing configured value, the following error message appears: "tech-support password is already configured". A prompt then appears to accept entry of the old password: "Enter old tech-support password:".

Entering **old-password** *old\_password* allows you to replace the existing password without being prompted to enter the old password. If you incorrectly enter the old password or do not enter the old password, an error message appears: "Failure: Must enter matching old tech-support password to replace existing password".

The Quick Setup Wizard (Exec mode **setup** command) also prompts for entry of a tech-support test-commands password. If you have forgotten the old tech-support password, you can run **setup** directly from the Console port to enter a new tech-support password.

When a test-commands password is configured, the Global Configuration mode command **cli test-commands** [ **encrypted** ] **password** *password* requires the entry of the password keyword. If the **encrypted** keyword is specified, the *password* argument is interpreted as an encrypted string containing the password value. If the **encrypted** keyword is not specified, the *password* argument is interpreted as the actual plain text value




---

**Important**

If **tech-support test-commands password** is never configured, StarOS will create a new password. If the **password** keyword is not entered for **cli test-commands**, the user is prompted (no-echo) to enter the password. Also, **cli hidden** must be enabled by an administrator to access the CLI test-commands.

---

## Exec Mode cli test-commands

Exec mode commands are available to a privileged user who enters the command **cli test-commands** from Exec mode.

```
[local]host_name# cli test-commands [encrypted] password password
Warning: Test commands enables internal testing and debugging commands
USE OF THIS MODE MAY CAUSE SIGNIFICANT SERVICE INTERRUPTION
```




---

**Important**

An SNMP trap (starTestModeEntered) is generated whenever a user enters CLI test-commands mode.

---

## Configuration Mode cli test-commands

Configuration commands which provided access to low-level software parameters are accessible only after a privileged user enters the command **cli test-commands** from Global Configuration mode.

```
[local]host_name# config
[local]host_name(config)# cli test-commands [encrypted] password password
Warning: Test commands enables internal testing and debugging commands
USE OF THIS MODE MAY CAUSE SIGNIFICANT SERVICE INTERRUPTION
```



---

**Important** An SNMP trap (starTestModeEntered) is generated whenever a user enters CLI test-commands mode.

---



## CHAPTER 9

# Secure System Configuration File

- [Feature Summary and Revision History, on page 119](#)
- [Feature Description, on page 120](#)
- [How System Configuration Files are Secured, on page 120](#)
- [Configuring Signature Verification, on page 121](#)

## Feature Summary and Revision History

### Summary Data

|                                          |                                                                                                                                                                                                       |
|------------------------------------------|-------------------------------------------------------------------------------------------------------------------------------------------------------------------------------------------------------|
| Applicable Product(s) or Functional Area | All                                                                                                                                                                                                   |
| Applicable Platform(s)                   | ASR 5500<br>VPC-DI<br>VPC-SI                                                                                                                                                                          |
| Feature Default                          | Disabled                                                                                                                                                                                              |
| Related Changes in This Release          | Not Applicable                                                                                                                                                                                        |
| Related Documentation                    | <ul style="list-style-type: none"><li>• <i>ASR 5500 System Administration Guide</i></li><li>• <i>VPC-DI System Administration Guide</i></li><li>• <i>VPC-SI System Administration Guide</i></li></ul> |

### Revision History

| Revision Details  | Release |
|-------------------|---------|
| First Introduced. | 21.3    |

## Feature Description

A system configuration file contains crucial configuration information used to setup and operate the operator's network. The configuration file must be properly authenticated before it is loaded to avoid unauthorized changes to the file that could harm the network.

This feature enables the system configuration file to be signed with an RSA key to ensure the integrity and authenticity of the configuration file before it is loaded. The operator can sign the configuration file with a private key, and the system uses a public key to validate the signed configuration file before loading it.

## How System Configuration Files are Secured

### Create a Digital Signature

The operator can sign the configuration file using the following steps:

1. Perform an SHA512 hash on the configuration file to create a message digest.

**Example (Linux/OpenSSL):**

```
openssl dgst -sha512 -binary -out digest cfg_file
```

2. Create a digital signature by encrypting the message digest value with the RSA private key.

**Example (Linux/OpenSSL):**

```
openssl pkeyutl -sign -in digest -inkey pri_key.pem -out sig \
-pkeyopt digest:sha512 -pkeyopt rsa_padding_mode:pss \
-pkeyopt rsa_pss_saltlen:-2
```

3. Convert the digital signature to a base64 format (A '#' is added at the beginning, and a new line at the end).

**Example (Linux/OpenSSL):**

```
echo -n "#" > sig_base64
base64 sig -w 0 >> sig_base64
echo "" >> sig_base64
```

4. Append the original configuration file with the digital signature.

**Example (Linux/OpenSSL):**

```
cat sig_base64 cfg_file > signed_cfg_file
```

### Generating the Public and Private Keys

The RSA public key is stored in PEM format (.pem file), and can be generated using one of the following OpenSSL commands in the example below:

```
openssl rsa -in pri_key.pem -pubout -out pub_key.pem
--or--
openssl rsa -in pri_key.pem -RSAPublicKey_out -out pub_key.pem
```

An RSA private key in PEM format can be generated using the OpenSSL command in the following example:

```
openssl genrsa -out pri_key.pem 2048
```

For more information on the `openssl rsa` and `openssl genrsa` commands, refer their respective OpenSSL manual pages.

## Validate the Digital Signature

When signature verification is enabled, validation of the digital signature occurs when the system boots up and loads the configuration file (or any time when the config file is loaded). The system determines if signature verification is enabled (or disabled) by looking for the `.enable_cfg_pubkey` file in the secure directory. For more information, refer [Enable or Disable Signature Verification, on page 122](#).

The system validates the signed configuration file using the following steps:

1. Extract the RSA public signing key from the flash.
2. Extract the configuration file's digital signature (the first line).
3. Convert the signature from base64 to binary format.
4. Decrypt the signature using the RSA public key.
5. Calculate the SHA512 hash for the plain config file resulting in a message digest.
6. Compare the decrypted signature value and newly calculated message digest. If they match, the configuration file is successfully validated.

## Configuring Signature Verification

### Import RSA Public Key for Verification

To verify the signed configuration file, an RSA public key (in PEM format) must be imported. Use the following command to import the RSA public key:



#### Important

This command can only be executed from the console.

```
cfg-security import public-key url url_address
```

#### Notes:

- Any existing `.pem` file will be replaced with the new `.pem` file when the command is executed.
- `url_address` may refer to a local or a remote file, and must be entered using the following format:

```
[file:]{/flash | /usb1 | /hd-raid | /sftp}{/directory}/filename
```

```
tftp://host[:port][/<directory>]/filename
```

```
ftp://[username[:password]@]host[:port][/directory]/filename
```

```
sftp://[username[:password]@]host[:port][/directory]/filename
```

```
http://[username[:password]@]host[:port][/directory]/filename
```

```
https://[username[:password]@]host[:port][/directory]/filename
```

## Enable or Disable Signature Verification

Use the following command to enable (or disable) signature verification in the configuration file:



---

**Important** This command can only be executed from the console.

---

```
[no] cfg-security sign
```

**Notes:**

- Enabling signature verification (**cfg-security sign** command) will create an empty file named *.enable\_cfg\_pubkey* in the same directory where the PEM file exists.
- Use the **no cfg-security sign** command to disable verification of signature in the configuration file. Disabling signature verification (**no cfg-security sign** command) will remove the *.enable\_cfg\_pubkey* file.
- The system looks for the *.enable\_cfg\_pubkey* file to determine if signature verification is enabled or disabled.



## CHAPTER 10

# Software Management Operations

---

This chapter provides information about software management operations on the system.

- [Understanding the Local File System, on page 123](#)
- [Maintaining the Local File System, on page 124](#)
- [Configuring the Boot Stack, on page 129](#)
- [Upgrading the Operating System Software, on page 133](#)
- [Performing Dynamic Software Updates, on page 157](#)
- [Managing License Keys, on page 158](#)
- [Managing Local-User Administrative Accounts, on page 161](#)

## Understanding the Local File System

The Management Input/Output (MIO/UMIO/MIO2) card provides control and management for the system.

The local file system is made up of files that are stored on one or more of the following:

- **/flash** - Flash memory located on the circuit board of the MIO/UMIO/MIO2, is the default storage media for the operating system software image, CLI configuration, and crash log files used by the system.
- **/usb1** - This device is available when a USB memory stick is inserted on the front panel of the active MIO/UMIO/MIO2.
- **/hd-raid** - This is the solid state hard disk array supported by the Fabric and Storage Cards (FSCs) and accessed via the active MIO/UMIO/MIO2.

## File Types Used by the Local File System

The following file types can be located in the local file system:

- **Operating System Software Image File:** This binary file type is identified by its **.bin** extension. The file is the operating system that is loaded by the system upon startup or reloading. This is an executable, read-only file that cannot be modified by end users.
- **CLI Configuration File:** This file type is identified by its **.cfg** extension. These are text files that contain CLI commands that work in conjunction with the operating system software image. These files determine services to be provided, hardware and software configurations, and other functions performed by the

system. The files are typically created by the end user. You can modify the files both on and off-line and use descriptive long filenames.

- **System File:** Only one file identified by a `.sys` extension is used by the system. The `boot.sys` file contains system-specific information, which describes how the system locates, and in what priority it loads, file groups (paired `.bin` and `.cfg` files) from its boot stack.
- **Abridged Crash Log:** The abridged crash log, identified by its `crashlog` filename, contains summary information about software or hardware failures that occur on the system. This file is located in the `/flash/crsh2/` directory on the device. You can view the contents of this file through the CLI, but you cannot modify the file.

## Understanding the boot.sys File

The system uses the `boot.sys` file to store the prioritized boot stack parameters and file groups the system uses during startup. Modify this file only through system CLI commands and not through external means. Boot parameters contain information the system needs to locate the operating system image file, including:

- **bootmode:** This setting is typically configured to normal, and identifies how the system starts.
- **network interface configuration:** Use these optional boot method settings when you configure the system to obtain its operating system image from an external network server that is using one of the management LAN interfaces on the MIO/UMIO/MIO2 card.
- **boot stack information:** The boot stack is made up of prioritized file group entries that designate the operating system image file and the CLI configuration file to load.

When a system is started for the first time, the `boot.sys` file is configured to use the normal boot mode and load the operating system software image from the `/flash` directory.

There is no CLI configuration file contained on the local file system. This causes the system to automatically start its CLI-based Quick Setup Wizard upon the first successful boot. Refer to *Getting Started* for more information on using the Quick Setup Wizard.

## Maintaining the Local File System

Use CLI commands to manage and maintain the devices that make up the local file system. Execute all the commands described in this section in the Exec Mode. Unless otherwise specified, you must have security administrator or administrator privileges to execute these commands.

### File System Management Commands

Use the commands in this section to manage and organize the local file system.



#### Important

For complete information on the commands listed below, see the *Exec Mode Commands* chapter of the *Command Line Interface Reference*.



## Synchronizing the File System

Commands are supported for mirroring the local file systems from the active MIO/UMIO/MIO2 to the standby MIO/UMIO/MIO2 in systems containing two cards. Use these commands to synchronize any or all of the local devices.



### Important

Crash log files are not synchronized when these commands are executed.

The following Exec mode command synchronizes the file systems between two MIO/UMIO/MIO2s:

```
[local]host_name# filesystem synchronize [/flash | /usb1 | all] [checkonly] [from card_num | to card_num] [-noconfirm]
```

Only filesystems on matching local devices are synchronized. For example, if the active MIO/UMIO/MIO2 contains two local devices (/flash and /usb1) and the standby MIO/UMIO/MIO2 contains only one local device (/flash), then synchronization only occurs on the matching local device (/flash).

The following command synchronizes the file systems on two MIO/UMIO/MIO2 flash devices.

```
[local]host_name# filesystem synchronize /flash
```

## Creating Directories

Use the **mkdir** command to create a new directory on the specific local device. This directory can then be incorporated as part of the path name for any file located in the local file system.

```
[local]host_name# mkdir { /flash | /usb1 | /hd-raid } /dir_name
```

Use the following command to create a directory named *configs*:

```
[local]host_name# mkdir /flash/configs
```

## Renaming Files and Directories

Use the **rename** command to change the name of a file from its original name to a different name. Remember to use the same file extension, if applicable, to ensure that the file type remains unchanged.

```
[local]host_name# rename { /flash | /usb1 | /hd-raid } /src_filename { /flash | /usb1 | /hd-raid } /dst_filename [-noconfirm]
```

Use the following command to rename a file named *iot\_test.cfg* to *iot\_accept.cfg* on the */flash* local device.

```
[local]host_name# rename /flash/iot_test.cfg /flash/iot_accept.cfg -noconfirm
```



### Important

Use the **rename** command only within the same local device. You cannot rename a file and place it onto another local device at the same time. To move a renamed file, you must use the **copy** command.

## Copying Files

These instructions assume that you are at the root prompt for the Exec mode. To save your current configuration, enter the following command:

```
[local]host_name# copy from_url to_url [-noconfirm]
```

To copy a configuration file called *system.cfg* from a directory that was called *cfgfiles* to a directory named *configs\_old*, enter the following command:

```
[local]host_name# copy /flash/cfgfiles/system.cfg
/flash/configs_old/system_2011.cfg
```

To copy a configuration file called *init\_config.cfg* to the root directory of a TFTP server with a hostname of *config\_server*, enter the following command:

```
[local]host_name# copy /flash/cfgfiles/init_config.cfg
tftp://config_server/init_config.cfg
```

## Deleting Files

The **delete** command removes a designated file from its specified location on the local file system.



### Important

This command does not support wildcard entries; each filename must be specified in its entirety.



### Caution

Do not delete the boot.sys file. If deleted, the system will not reboot on command and will be rendered inoperable.

```
[local]host_name# delete { /flash | /usb1 | /hd-raid }/filename [-noconfirm
]
```

The following command deletes a file named *test.cfg* from the */flash* directory.

```
[local]host_name# delete /flash/test.cfg
```

## Removing Directories

The **rmdir** command deletes a current directory on the specific local device. This directory can then be incorporated as part of the path name for any file located in the local file system.



### Important

The directory you want to remove (delete) must be empty before executing the **rmdir** command. If the directory is not empty, the CLI displays a "Directory not empty" message and will not execute.

```
[local]host_name# rmdir url /dir_name
```

The following command deletes an empty directory named *configs* in the */flash* directory.

```
[local]host_name# rmdir /flash/configs
```

## Formatting Local Devices

The **format** command performs a low-level format of a local device. This operation formats the device to use the FAT16 formatting method, which is required for proper read/write functionality with the operating system.

**Important**

Local devices that have been formatted using other methods such as NTFS or FAT32 may be used to store various operating system, CLI configuration, and crash log files. However, when placing a new local device into the MIO/UMIO/MIO2 for regular use, you should format the device via the system prior to use. This ensures that the proper file allocation table format is used, preventing any possible discrepancies between other formats used with other operating systems.

**Caution**

The **filesystem format** command removes all files and information stored on the device.

To format a local device for use by the local file system, enter the following command:

```
[local]host_name# filesystem format { /flash | /usb1 | /hd-raid }
```

## Applying Pre-existing CLI Configuration Files

A pre-existing CLI configuration file is any .cfg file created to provide utility functions (such as clearing all statistics during testing) or created off-line using a text editor. There may be pre-existing configuration files stored on the local file system that can be applied to a running system at any time.

**Caution**

If a configuration file is applied to a system currently running another CLI configuration, any like contexts, services, logical interfaces, physical ports, IP address pools, or other configured items will be overwritten if the same command exists in the configuration file being applied. Take caution to ensure that you are knowledgeable of the contents of the file being applied and understand what the service ramifications are if a currently running command is overwritten. Also note that changes will not be saved automatically.

A CLI configuration file, or script containing CLI commands, can be applied to a running system by entering the following command at the Exec mode prompt:

```
[local]host_name# configure url [verbose]
```

*url* specifies the location of the CLI configuration file to be applied. It may refer to a local or a remote file.

The following command applies a pre-existing CLI configuration file named *clearcmds.cfg* in the */flash* directory.

```
[local]host_name# configure /flash/clearcmds.cfg
```

## Viewing Files on the Local File System

This section describes how to view a variety of files.

### Viewing the Contents of a Local Device

The contents, usage information, and file system directory structure of any local device can be viewed by entering the following command at the Exec mode prompt:

```
directory { /flash | /usb1 | /hd-raid }
```

## Viewing CLI Configuration and boot.sys Files

The contents of CLI configuration and boot.sys files, contained on the local file system, can be viewed off-line (without loading them into the OS) by entering the following command at the Exec mode prompt:

```
[local]host_name# show file url { /flash | /usb1 | /hd-raid } filename
```

Where: *url* is the path name for the location of the file and *filename* is the name of the file, including any extension.



### Important

Operator and inspector-level users can execute the **show file** command but cannot execute the **directory** command.

## Validating an Operating System File

The operating system software image file, identified by its .bin extension, is a non-readable, non-editable file that executes on the system, creating its runtime operating system (OS).

It is important to verify a new operating system image file before attempting to load it. To accomplish this, a proprietary checksum algorithm is used to create checksum values for each portion of the application stored within the .bin file during program compilation.

This information can be used to validate the actual file against the checksum values stored within the file during its compilation. If any portion of the image file has become corrupted (for example, the file was truncated or was transferred using ASCII mode instead of binary mode), then this information is reported and the file is deemed unusable.

To validate an operating system software image file, enter the following command at the Exec mode prompt:

```
[local]host_name# show version { /flash | /usb1 | /hd-raid } /[directory]/filename
[all]
```

The output of this command displays the following information:

- Version number
- Description
- Date
- Boot Image
- Size
- Flags
- Platform

If an invalid file is found, the system displays a failure message similar to these:

```
Failure: Image /flash/image_version.bin CRC check failed!
Failure: /flash/image_version.bin, has a bad magic number
```

# Configuring the Boot Stack

The boot stack consists of a prioritized listing of operating system software image-to-CLI configuration file associations. These associations determine the software image and configuration file that gets loaded during system startup or upon a reload/reboot. Though multiple associations can be configured, the system uses the association with the highest priority. In the event that there is an error processing this association (for example, one of the files cannot be located), the system attempts to use the association with the next highest priority. Priorities range from 1 to 100, with 1 being the highest priority. The maximum number of boot stack entries that may be configured in the boot.sys file is 10.

Boot stack information is contained in the boot.sys file, described in [Understanding the boot.sys File, on page 124](#). In addition to boot stack entries, the boot.sys file contains any configuration commands required to define the system boot method as explained in the section that follows.

## System Boot Methods

The local-boot method uses software image and configuration files stored locally on the system. On system startup or reboot, the system looks on one of its local devices or **/hd-raid** for the specific software image and accompanying configuration text file. When using the local-booting method, you only need to configure boot stack parameters.

The system can also be configured to obtain its software image from a specific external network server while it is paired with a configuration text file that resides on the system. When using network booting, you need to configure the following:

- Boot stack parameters, which define the files to use and in what priority to use them
- Boot interface and network parameters defining the remote management LAN interface and the methods to use to reach the external network server
- Network booting delay time and optional name server parameters defining the delay period (in seconds) to allow for network communications to be established, and the IP address of any Domain Name Service (DNS) name server that may be used

Detailed information on how to configure the system to use the network booting method appears in [Network Booting Configuration Requirements, on page 131](#)

## Viewing the Current Boot Stack

To view the boot stack entries contained in the boot.sys file run the Exec mode **show boot** command.



### Important

Operator and inspector-level users can execute the **show boot** command.

The examples below shows the command output for a local booting configuration. Notice that in these examples both the image file (operating system software) and configuration file (CLI commands) are located on the **/flash** device.

**Important**

The StarOS image filename scheme changed with release 16.1. Pre-16.1, format = "production.*image*.bin". For 16.1 onwards, format = "asr5500-*image\_number*.bin". This change is reflected in the examples provided below.

**Example 1 – StarOS releases prior to 16.1:**

```
boot system priority 18 \
 image /flash/15-0-builds/production.45666.bin \
 config /flash/general_config.cfg

boot system priority 19 \
 image /flash/15-0-builds/production.45717.bin \
 config /flash/general_config_3819.cfg

boot system priority 20 \
 image /flash/15-0-builds/production.45069.bin \
 config /flash/general_config_3665.cfg
```

**Example 2 – StarOS release 16.1 onwards:**

```
boot system priority 18 \
 image /flash/16-1-builds/asr5500-16.1.3.bin \
 config /flash/general_config.cfg

boot system priority 19 \
 image /flash/16-1-builds/asr5500-16.1.1.bin \
 config /flash/general_config_3819.cfg

boot system priority 20 \
 image /flash/16-1-builds/asr5500-16.1.0.bin \
 config /flash/general_config_3665.cfg
```

The example below shows the output for a combination network booting and local booting configuration. Notice in this example that the first two boot stack entries (Priorities 18 and 19) load the image file (operating system software) from an external network server using the Trivial File Transfer Protocol (TFTP), while all configuration files are located on the **/flash** device.

Also notice the boot network interface and boot network configuration commands located at the top of the boot stack. These commands define what remote management LAN interface(s) to use and information about communicating with the external network server that hosts the operating system software image file.

```
boot networkconfig static ip address mio1 192.168.1.150 netmask 255.255.255.0
boot delay 15
boot system priority 18 image tftp://192.168.1.161/tftpboot/image_version.bin \config
/flash/general_config.cfg
boot system priority 19 image tftp://192.168.1.161/tftpboot/image_version.bin \config
/flash/general_config.cfg
boot system priority 20 image /flash/image_version.bin \config /flash/general_config.cfg
```

To identify the boot image priority that was loaded at the initial boot time enter:

**show boot initial-config**

The example below displays the output:

```
[local]host_name# show boot initial-config
Initial (boot time) configuration:
 image tftp://192.168.1.161/tftpboot/image_version.bin \
 config /flash/config_name.cfg
 priority 1
```

## Adding a New Boot Stack Entry

**Important**

Before performing this procedure, verify that there are less than 10 entries in the `boot.sys` file and that a higher priority entry is available (i.e. that minimally there is no priority 1 entry in the boot stack). Refer to *Viewing the Current Boot Stack* for more information.

If priority 1 is in use, then you must renumber the existing entry(ies) to ensure that at least that priority is available. The maximum number of boot stack entries that can be contained in the `boot.sys` file is 10. If there are already 10 entries in the boot stack, you must delete at least one of these entries (typically, the lowest priority) and, if necessary, renumber some or all of the other entries before proceeding. Refer to [Deleting a Boot Stack Entry, on page 131](#) for more information.

This procedure details how to add new boot stack entries to the `boot.sys` file. Make sure you are at the Exec mode prompt and enter the following commands:

```
configure
boot system priority number image image_url config cfg_url
```

The following command creates a new boot stack entry, using a boot priority of 3.

```
boot system priority 3 image /flash/image_filename.bin config
/flash/config_name.cfg
```

**Important**

Boot stack changes saved to the `boot.sys` file are not executed until the system is rebooted.

Synchronize the local file systems on the MIO/UMIO/MIO2s with the following command:

```
filesystem synchronize all
```

## Deleting a Boot Stack Entry

This procedure details how to remove an individual boot stack entry from the `boot.sys` file. Make sure you are at the Exec mode prompt and enter the following commands:

```
configure
no boot system priority number
```

Where *number* specifies the boot priority used for the boot stack entry. This command removes that specific entry from the boot stack, causing the `boot.sys` file to be overwritten.

## Network Booting Configuration Requirements

### Configuring the Boot Interface

Boot interface parameters define the MIO/UMIO/MIO2 management LAN interface that the system will use to communicate with the management network when using the network booting method.

This procedure details how to configure the boot interface for reliable communications with your network server. Make sure you are at the Exec mode prompt.

**Step 1** Enter the Global Configuration mode by entering the following command:

```
[local]host_name# configure
```

The following prompt appears:

```
[local]host_name(config)#
```

**Step 2** Enter the following command:

```
[local]host_name(config)#boot interface { local-eth1 | local-eth2 } medium { auto | speed { 10 | 100 | 1000 } duplex { full | half } } media { rj45 | sfp }
```

For complete information about the above command, see the *Global Configuration Mode Commands* chapter in the *Command Line Interface Reference*.

Use port 1 for network booting.

If the speed is manually configured, you must also configure the duplex mode. In addition, you must ensure that the network server configuration supports the speed and duplex configuration.

Network speed for MIO/UMIO/MIO2 is fixed at **1000**.

Ethernet networking rules dictate that if a device's interface is configured for auto-negotiation is communicating with a device that is manually configured to support full duplex, the first device will negotiate to the manually configured speed of the second device, but will only communicate in half duplex mode.

The media for MIO/UMIO/MIO2 port 1 is fixed at **rj45**.

**Step 3** Save the configuration as described in the *Verifying and Saving Your Configuration* chapter.

## Configuring the Boot Network

Boot network parameters define the protocols and IP address information for MIO/UMIO/MIO2 interfaces used to reach the external network server that hosts the operating system software image file. To configure boot network parameters, make sure you are at the Exec mode prompt.

**Step 1** Enter the Global Configuration mode by entering the following command:

```
[local]host_name(config)#configure
```

The following prompt appears:

```
[local]host_name(config)#
```

**Step 2** Enter the following command:

```
[local]host_name(config)# boot networkconfig { dhcp | { { dhcp-static-fallback | static } ip address mio5 ip_address5 [mio6 ip_address6] netmask subnet_mask [gateway gw_ip_address] } }
```

For complete information about the above command, see the *Global Configuration Mode Commands* chapter in the *Command Line Interface Reference*.

The following command configures the boot network to communicate using DHCP, with a static-fallback IP address for MIO/UMIO/MIO2 in slot 5 of 192.168.206.101 and a Class C netmask.



```
[local]host_name(config)# boot networkconfig dhcp-static-fallback ip address mio5
192.168.206.101 netmask 255.255.255.0
```

The next example uses static IP addresses for MIO/UMIO/MIO2 in slot 5, which can access the external network server through a gateway whose IP address is 135.212.10.2.

```
[local]host_name(config)# boot networkconfig static ip address mio5 192.168.206.101
netmask 255.255.255.0 gateway 135.212.10.2
```

**Step 3** Save the configuration as described in the *Verifying and Saving Your Configuration* chapter.

---

## Configuring Boot Network Delay Time

An optional delay period, in seconds, can be configured for systems booting from a network. The purpose of this parameter is to allow time for external devices, such as switches, that use the Spanning Tree Protocol (STP) to determine the network route to a specified IP address.

To configure a boot network delay, enter the following command from the Global Configuration mode prompt.

```
[local]host_name(config)# boot delay time
```

Where *time* is an integer from 1 to 300 seconds before attempting to contact the external network server. If your network uses STP, a typical delay time of 30 seconds should suffice.



---

**Important** Save your configuration as described in the *Verifying and Saving Your Configuration* chapter.

---

## Configuring a Boot Nameserver

To configure a boot nameserver address, enter the following command from the Global Configuration mode prompt.

```
[local]host_name(config)# boot nameserver ip_address
```

Where *ip\_address* is the IP address of the DNS server entered in IPv4 dotted-decimal notation.



---

**Important** Save the configuration as described in the *Verifying and Saving Your Configuration* chapter.

---

## Upgrading the Operating System Software

This section describes how to manually perform the StarOS binary image upgrade procedure.

Prior to initiating the StarOS software upgrade procedure, make sure the conditions described in the [Prerequisites](#), on page 134 section are met.



---

**Caution** Undeploying/redeploying VPC is not supported after the bin upgrade. Deactivating VPC removes the upgraded StarOS bin image.

---

To upgrade the StarOS software manually:

1. [Obtain VIP Addresses for AutoVNF, CF, ESC and UEM, on page 134](#)
2. [Identify OS Release Version and Build Number, on page 136](#)
3. [Download the Software Image from the Support Site, on page 137](#)
4. [Verify Zookeeper Database, on page 137](#)
5. [Verify ESC Database, on page 138](#)
6. [Verify Free Space on the /flash Device, on page 139](#)
7. [Transfer StarOS Image to /flash, on page 139](#)
8. [Save the Running Configuration, on page 144](#)
9. [Synchronize File Systems, on page 152](#)
10. [Reboot the System, on page 146](#)

## Prerequisites

Prior to performing an upgrade of StarOS software containing CF and SF VNFCs, check if the following prerequisites are met:

- You'll need the login credentials and IP address of AutoDeploy, AutoVNF, ESC, UEM, and CF VMs. You should have administrative rights to the OpenStack setup.
- Verify the OpenStack status. The Ansible output should all pass.

```
cd /home/stack/
source stackrc
cd /home/stack/ansible/
ansible-playbook -i inventory openstack_verify.yml
```

- Check if the health of AutoVNF/ESC/EM/VNF VM is normal through the UltraM health logs on AutoIT. If any of the VM(s) are not normal, then take necessary actions to recover the health of the corresponding VM(s).
- You should have the new StarOS binary image file (for manual upgrade).
- Ensure that there are no pending transactions between ESC, UEM and CF.
- Be sure to take a backup of the original StarOS bin file.

## Obtain VIP Addresses for AutoVNF, CF, ESC and UEM

This section provides instructions that are applicable only to the upgrade of CF and SF VNFCs.

To collect the VIP addresses for AutoVNF, CF, ESC and UEM VMs:

1. Log on to the AutoDeploy VM as the default user, *ubuntu*.
 

```
ssh ubuntu@<ad_vm_address>
```
2. Switch to the *root* user.

```
sudo -i
```

3. Enter the ConfD CLI.

```
confd_cli -u admin -C
```

4. Enter the *admin* user credentials when prompted.

5. Collect the VIP address of AutoVNF, ESC, UEM and CF VMs.

```
show vnfr
```

Example output:

```
vnfr autoit-f-autovnf
vnfd f-autovnf
vnf-type usp-uas
state deployed
external-connection-point avf
virtual-link-ref management
ip-address 192.168.100.26
floating-ip-address 10.225.202.94
vnfr sj-autovnf-esc
vnfd esc
vnf-type esc
state deployed
external-connection-point esc
virtual-link-ref management
ip-address 192.168.100.22
vnfr sj-autovnf-vpc
vnfd vpc
vnf-type ugp
state alive
external-connection-point cf
virtual-link-ref management
ip-address 192.168.100.38
external-connection-point em
virtual-link-ref management
```

```
ip-address 192.168.100.21
```

## Identify OS Release Version and Build Number

The operating system can be configured to provide services and perform pre-defined functions through commands issued from the CLI.

The operating system software is delivered as a single binary file (**.bin** file extension) and is loaded as a single instance for the entire system.

- For StarOS releases prior to 16.1, the image filename is identified by its release type, build number and platform type. For example: **production.build\_number.asr5500.bin**. For example, **production.54029.asr5500.bin**.
- For StarOS release 16.1 onwards, the image filename is identified by a suffix specifying its platform type and release number. For example, **asr5500-release\_number.bin**. For example, **asr5500-16.1.0.bin**.

For StarOS releases 20.0 and higher, a starfile image must be signed with an REL key before being released. A deployable image will be signed with an REL key having a ".bin.SPA" extension, where "A" identifies the revision level of the signing key. For example, **asr5500-20.0.0.bin.SPA**. If a signing key becomes compromised, a new key is created and the revision level increments to "B".

For StarOS releases 20.0 and higher Trusted images have been introduced. The difference between a Trusted build and a Normal build is the absence of unsecure programs ftpd, telnet and tcpdump, as well as the addition of a staros.conf file for security options. Trusted images are identifiable by the presence of "\_T" in the platform name. For example, **asr5500\_T-20.0.0.bin.SPA**.

To identify the StarOS software version and build information:

1. Log on to the VNF to be upgraded.
2. Enter the following Exec mode command in the StarOS command line interface:

```
show version
```

Example output:

```
Active Software:
```

```
Image Version: 21.9.0.69918
Image Build Number: 69918
Image Description: Deployment_Build
Image Date: Sun Jul 22 12:08:55 EDT 2018
Boot Image: /flash/staros.bin
Source Commit ID: 94797337b6c1691541ea0dd86f2f29b0f2c3630c
```

3. Execute the following Exec mode command to display additional information about the StarOS build release.

```
show build
```

## Download the Software Image from the Support Site

This section provides instructions that are applicable only to the upgrade of CF and SF VNFs.

Access to the Cisco support site and download facility is username and password controlled. You must have an active customer account to access the site and download the StarOS image.

Download the software image to a network location or physical device (USB stick) from which it can be uploaded to the *flash* device. Contact your Cisco representative or Cisco TAC for additional information.

For UGP-based VNF, perform the following steps to download the new bin file to AutoVNF or OSPD VM.

1. Log on to the AutoVNF of the corresponding VNF.

```
ssh ubuntu@<ad_vm_address>
```

Command example:

```
ssh ubuntu@10.225.202.94
```

2. Create a directory to download the new StarOS qvpc-di binary file to AutoVNF/OSPD.

```
cd /home/ubuntu/
```

```
mkdir StarOSBinUpgrade
```

3. Download the new StarOS qvpc-di binary file from the Cisco support site and copy the file to the *StarOSBinUpgrade* directory.

```
cd StarOSBinUpgrade
```

Then, use the following command to verify if the directory contains the new bin file.

```
ls -lrt /home/ubuntu/StarOSBinUpgrade
```

Example output:

```
total 172560
```

```
-r--r--r-- 1 ubuntu ubuntu 176698880 Jul 24 23:29 qvpc-di-21.9.0.69932.bin
```

## Verify Zookeeper Database

This section provides instructions that are applicable only to the upgrade of CF and SF VNFs.

To verify the zookeeper database:

1. Log on to the AutoVNF using the floating IP.

```
ssh ubuntu@<ad_vm_address>
```

Command example:

```
ssh ubuntu@10.225.202.94
```

2. Log on to the UEM VM using the VIP address fetched in the [Obtain VIP Addresses for AutoVNF, CF, ESC and UEM, on page 134](#).

```
ssh ubuntu@<vip-addr>
```

Command example:

```
ssh ubuntu@192.168.100.21
```

3. Become the *root* user.

```
sudo -i
```

4. Collect the UEM orchestration IP address for Zookeeper database connection.

```
#ifconfig
```

```
eth0 Link encap:Ethernet HWaddr fa:16:3e:71:1d:08
 inet addr:192.168.200.12 Bcast:192.168.200.255 Mask:255.255.255.0
```

5. Navigate to the */opt/cisco/usp/packages/zookeeper/<current>/bin* directory.

6. Execute the following script from the command line to access the UEM Zookeeper database.

```
zkCli.sh -server ip_addr:port_num
```

For example:

```
zkCli.sh -server 192.168.200.12:2181
```

7. Check the zookeeper database and ensure that there are no pending requests between UEM and CF VMs.

```
ls /request
```

Example output:

```
[]
```

<Ctrl+D to exit Zookeeper shell>

## Verify ESC Database

This section provides instructions that are applicable only to the upgrade of CF and SF VNFs.

To verify the ESC database:

1. Log on to the AutoVNF using the floating IP.

```
ssh ubuntu@<ad_vm_address>
```

Command example:

```
ssh ubuntu@10.225.202.94
```

2. Log on to the ESC VM using the VIP address fetched in the [Obtain VIP Addresses for AutoVNF, CF, ESC and UEM, on page 134](#).

```
ssh admin@<vip-addr>
```

Command example:

```
ssh admin@192.168.100.22
```

3. Check the ESC database to ensure there are no pending transactions.

```
sudo /opt/cisco/esc/pgsql/bin/psql -U esc -p 7878 -h localhost -c
'select * from esc_schema.workitem';
```

```
config_id | request_id | mo_type | config_action | config_state
```






---

**Important** Whenever transferring a operating system software image file using the file transfer protocol (FTP), the FTP client must be configured to transfer the file using binary mode. Failure to use binary transfer mode will make the transferred operating system image file unusable. In release 20.0 and higher Trusted StarOS builds, FTP is not supported.

---

- Transfer the file to the */flash* device using an SFTP client with access to the system.

For UGP-based VNF, copy the new StarOS bin to the active CF by following these steps.

1. Log on to the AutoVNF or OSPD VM where the new bin file is downloaded.

```
ssh ubuntu@<ad_vm_address>
```

Command example:

```
ssh ubuntu@10.225.202.94
```

2. Navigate to the directory where the new bin file is downloaded from the Cisco support site.

```
cd /home/ubuntu/StarOSBinUpgrade/ && ls -lrt
```

Example output:

```
total 172560
```

```
-r--r--r-- 1 ubuntu ubuntu 176698880 Jul 24 23:29 qvpc-di-21.9.0.69932.bin
```

3. SFTP to the CF VM.

For example:

```
sftp ubuntu@192.168.100.38
```

4. Navigate to the *sftp* directory.

```
#sftp>pwd
```

```
Remote working directory: /
```

```
#sftp>ls
```

```
hd-raid sftp
```

```
#sftp>cd sftp
```

5. Upload the new binary file to the *sftp* directory.

```
#sftp>put image_filename.bin
```

Example output:

```
#sftp>put qvpc-di-21.9.0.69932.bin
```

```
Uploading qvpc-di-21.9.0.69932.bin to /.auto/onboard/flash/sftp/qvpc-di-21.9.0.69932.bin
qvpc-di-21.9.0.69932.bin 100% 169MB 168.5MB/s 00:01
```

6. Log on to the CF VM using the VIP address fetched in the [Obtain VIP Addresses for AutoVNF, CF, ESC and UEM, on page 134](#).

```
ssh ubuntu@<vip-addr>
```



Command example:

```
ssh ubuntu@192.168.100.38
```

7. Copy the new bin from *sftp* to *flash* directory.

```
copy /flash/sftp/image_filename.bin /flash/updated.bin
```

Example output:

```
#copy /flash/sftp/qvpc-di-21.9.0.69932.bin /flash/updated.bin
```

```

```

```
Transferred 176698880 bytes in 2.718 seconds (63486.9 KB/sec)
```

8. Delete the new bin from *sftp* directory.

```
delete /flash/sftp/image_filename.bin
```

Example output:

```
delete /flash/sftp/qvpc-di-21.9.0.69932.bin
```

```
Are you sure? [Yes|No]: yes
```

```
File /flash/sftp/qvpc-di-21.9.0.69932.bin removed
```

9. Verify that the image file was successfully transferred to the */flash* device by running the following Exec mode command:

```
[local]host_name# directory /flash
```

The image filename should appear in the displayed output.

10. Execute the following command to verify the build information.

```
show version /flash/image_filename.bin
```

## Saving a Copy of the Current Configuration File

Prior to upgrading to a new software release, you should copy and rename the current configuration file to the */flash* device and to an off-chassis location (external memory device or network URL). This renamed copy assures that you will have a fallback, loadable configuration file should a problem be encountered during the upgrade.

## Downgrading from Release 15.0 to 14.0

Release 14 and Release 15 chassis IDs use different encryption formats. Release 15 will recognize a Release 14 chassis ID and consider it as valid. Upgrading from 14.x to 15.0 will not require changing the chassis ID or configuration file.

However, if the chassis key is reset in Release 15 through the setup wizard or **chassis-key** CLI command, a new chassis ID will be generated in Release 15 format (44 instead of 16 characters). Release 14 builds will not recognize the 44-character chassis ID. If the chassis is subsequently downgraded to Release 14, a new 16-character chassis ID will be generated. To accommodate the old key format, you must save the configuration file in pre-v12.2 format before the downgrade. If you attempt to load a v15 configuration file on the downgraded chassis, StarOS will not be able to decrypt the password/secrets stored in the configuration file.

## Downgrading from Release 20.0

Prior to release 20.0, local-user passwords were hashed with the MD5 message digest-algorithm and saved in the database. In release 20.0, PBKDF2 (Password Based Key Derivation Function - Version 2) is now used to derive a key of given length, based on entered data, salt and number of iterations. Local-user account passwords are hashed using the PBKDF2 method with a randomly generated salt coupled with a large number of iterations to make password storage more secure.

Since hash functions are one-way, it is not possible to convert PBKDF2 hashed passwords to the MD5 format. The local-user database must be downgraded prior to reverting to StarOS releases prior to 20.0.

To downgrade the local-user database to use the MD5 hash algorithm, a Security Administrator must run the Exec mode **downgrade local-user database** command. StarOS prompts for confirmation and requests the Security Administrator to reenter a password. The entered password re-authenticates the user prior to executing the downgrade command. After verification, the password is hashed using the appropriate old/weak encryption algorithm and saved in the database to allow earlier versions of StarOS to authenticate the Security Administrator.

The downgrade process does not convert PBKDF2 hashed passwords to MD5 format. The downgrade process re-reads the database (from the /flash directory), reconstructs the database in the older format, and writes it back to the disk. Since the PBKDF2 hashed passwords cannot be converted to the MD5 hash algorithm, and earlier StarOS releases cannot parse the PBKDF2 encryption algorithm, StarOS suspends all those users encrypted via the PBKDF2 algorithm. Users encrypted via the MD5 algorithm ("Weak Hash" flag) can continue to login with their credentials. After the system comes up with the earlier StarOS release, suspended users can be identified in the output of the **show local-user [verbose]** command.

To reactivate suspended users a Security Administrator can:

- Set temporary passwords for suspended users, using the Exec mode **password change local-user *username*** command.
- Reset the suspend flag for users, using the Configuration mode **no suspend local-user *username*** command.

## Off-line Software Upgrade

An off-line software upgrade can be performed for any system, upgrading from any version of operating system software to any version, regardless of version number. This process is considered off-line because while many of the steps can be performed while the system is currently supporting sessions, the last step of this process requires a reboot to actually apply the software upgrade.

This procedure assumes that you have a CLI session established and are placing the new operating system image file onto the local file system. To begin, make sure you are at the Exec mode prompt:

```
[local]host_name#
```

To perform offline software upgrade:

1. [Configure a Newcall Policy, on page 143](#)
2. [Configure a Message of the Day Banner, on page 143](#)
3. [Back up the Current CLI Configuration File , on page 143](#)
4. [Save the Running Configuration, on page 144](#)
5. [Create a New Boot Stack Entry, on page 145](#)

6. [Synchronize File Systems, on page 152](#)
7. [Reboot the System, on page 146](#)

## Configure a Newcall Policy

Configure a newcall policy from the Exec mode to meet your service requirements. When enabled the policy redirects or rejects new calls in anticipation of the system reload that completes the upgrade process. This reduces the amount of service disruption to subscribers caused by the system reload that completes the upgrade.



### Important

Newcall policies are created on a per-service basis. If you have multiple services running on the chassis, you can configure multiple newcall policies.

The syntax for newcall policies is described below:

```
[local]host_name# newcall policy { asngw-service | asnpc-service | sgsn-service
} { all | name service_name } reject
[local]host_name# newcall policy { fa-service | lns-service | mipv6ha-service
} { all | name service_name } reject
[local]host_name# newcall policy { ha-service | pdsn-service |
pdsnclosedrp-service } { all | name service_name } { redirect target_ip_address
[weight weight_num] [target_ipaddress2 [weight weight_num] ...
target_ip_address16 [weight weight_num] | reject }
[local]host_name# newcall policy ggsn-service { apn name apn_name | all | name
service_name } reject
[local]host_name# newcall policy hnbgw-service { all | name service_name } reject
[local]host_name# newcall policy { pcc-af-service | pcc-policy-service } {
all | name service_name } reject
[local]host_name# newcall policy {pcc-af-service | pcc-policy-service } { all
| name service_name } reject
[local]host_name# newcall policy mme-service { all | name service_name } reject
```

For complete information about the above commands, see the *Exec Mode Commands* chapter of the *Command Line Interface Reference*.

## Configure a Message of the Day Banner

*Optional:* Configure a "Message of the Day" banner informing other management users that the system will be rebooted by entering the following command from the Global Configuration mode prompt.

```
[local]host_name(config)# banner motd "banner_text"
```

*banner\_text* is the message that you would like to be displayed and can be up to 2048 alphanumeric characters. Note that *banner\_text* must begin with and end in quotation marks (" "). For more information in entering CLI banner information, see the *CLI Reference*. The banner is displayed when an administrative user logs onto the CLI.

## Back up the Current CLI Configuration File

Back up the current CLI configuration file by entering the following command:

```
[local]host_name# copy from_url to_url [-noconfirm]
```

This creates a mirror-image of the CLI configuration file linked to the operating system defined in the current boot stack entry.

The following command example creates a backup copy of a file called *general.cfg* located on the */flash* device to a file called *general\_3652.cfg*:

```
[local]host_name# copy /flash/general.cfg /flash/general_3652.cfg
```

## Save the Running Configuration

Save the currently running, upgraded configuration prior to rebooting the chassis.

To save the boot configuration:

1. Log on to the VNF using the VIP address fetched in the [Obtain VIP Addresses for AutoVNF, CF, ESC and UEM, on page 134](#).

```
ssh ubuntu@<vip-addr>
```

Command example:

```
ssh ubuntu@192.168.100.38
```

2. *Optional*. Execute the following command in the Exec mode.

```
chassis key value 1234
```

Save config before reload chassis, EVEN IF the same old key value is used. Old config scripts will become invalid after reload.



### Important

This step is optional, and needed only if the chassis key is not set.

3. Save the boot configuration in the flash directory.

```
save configuration /flash/system.cfg
```

```
Warning: About to overwrite boot configuration file
Are you sure? [Yes|No]: yes
```

This will update the boot configuration to use the new bin image.

Use the following command to check the boot configuration.

```
show boot
```

```
Monday May 21 20:39:57 UTC 2018
```

```
boot system priority 8 \
 image /flash/sftp/production.YYYY.qvpc-di.bin \
 config /flash/sftp/tb5_vnf1_dayN.cfg
```

```
boot system priority 9 \
 image /flash/staros.bin \
 config /flash/sftp/tb5_vnf1_dayN.cfg
```

```
boot system priority 10 \
 image /flash/staros.bin \
 config /flash/system.cfg
```

4. Enter the configuration mode to change the boot priority of new StarOS bin file.

```
#config
#boot system priority 1 image /flash/updated.bin config
/flash/system.cfg
#end
```

5. Verify the new boot priority.

```
#show boot
```

```
boot system priority 1 \
 image /flash/updated.bin \
 config /flash/system.cfg
boot system priority 10 \
 image /flash/staros.bin \
 config /flash/system.cfg
```

6. Verify whether the flash directory contains the boot configuration and new bin.

```
dir /flash
```

```
total 320376
-rw-rw-r-- 1 root root 134 May 3 10:11 boot.sys
-rw-rw-r-- 1 root root 3920672 May 11 19:49 crashlog2
drwxrwxr-x 2 root root 4096 May 11 19:49 crsh2
-rw-rw-r-- 1 root root 156 May 11 19:49 module.sys
drwxrwxr-x 3 root root 4096 May 11 19:49 patch
drwxrwxr-x 2 root root 4096 May 11 19:49 persistdump
-rw-rw-r-- 1 root root 79 May 11 19:49 restart_file_cntr.txt
drwxrwxr-x 3 root root 4096 May 11 20:07 sftp
-rw-rw-r-- 1 root root 160871936 May 3 10:11 staros.bin
-rw-rw-r-- 1 root root 5199 May 11 19:57 system.cfg
-rw-rw-r-- 1 root root 163227136 May 11 20:07 updated.bin
320476 /flash
Filesystem 1K-blocks Used Available Use% Mounted on
/var/run/storage/boot1/part2
4112620 320476 3792144 8% /mnt/user/.auto/onboard/flash
```

## Create a New Boot Stack Entry

Create a new boot stack entry for the new file group, consisting of the new operating system image file and the currently used CLI configuration file by entering the following Global Configuration command:

```
[local]host_name(config)# boot system priority number image image_url /flash filename
config cfg_url /flash/filename
```

Assign the next highest priority to this entry, by using the <N-1> method, wherein you assign a priority number that is one number less than your current highest priority.



### Important

Run the Exec mode **show boot** command to verify that there are less than 10 entries in the boot.sys file and that a higher priority entry is available (minimally there is no priority 1 entry in the boot stack).

If priority 1 is in use, you must renumber the existing entries to ensure that at least that priority is available.

The maximum number of boot stack entries that can be contained in the `boot.sys` file is 10. If there are already 10 entries in the boot stack, you must delete at least one of these entries (typically, the lowest priority) and, if necessary, renumber some or all of the other entries before proceeding. Use the `no boot system priority` command to delete a boot stack entry.

```
[local]host_name# configure
[local]host_name(config)# no boot system priority number
```

To add new boot stack entries to the `boot.sys` file enter the following commands:

```
[local]host_name# configure
[local]host_name(config)# boot system priority number image image_url config cfg_url
```

For information on using the `boot system priority` command, refer to the [Adding a New Boot Stack Entry, on page 131](#).

## Synchronize File Systems

Synchronize the local file systems on the management cards by entering the following command:

```
[local]host_name# filesystem synchronize all
```

## Reboot the System

To reboot the system (VNF):

1. Log on to the VNF using the VIP address fetched in the [Obtain VIP Addresses for AutoVNF, CF, ESC and UEM, on page 134](#).

```
ssh ubuntu@<vip-addr>
```

Command example:

```
ssh ubuntu@192.168.100.38
```

2. Enter the following Exec mode command:

```
[local]host_name# reload [-noconfirm]
```

As the system reboots, it loads the new operating system software image and its corresponding CLI configuration file using the new boot stack entry configured earlier.

3. *Optional for PDSN:* If you are using the IP Pool Sharing Protocol during your upgrade, refer to *Configuring IPSP Before the Software Upgrade* in the *PDSN Administration Guide*.
4. After the reload is complete, log on to the VNF and make sure it is loaded with the intended StarOS version and all the cards have booted up and are in active or stand-by state as expected.

```
show version
```

Example output:

```
Active Software:
 Image Version: 21.9.0.69977
 Image Build Number: 69977
 Image Description: Build
 Image Date: Mon Jul 30 06:48:34 EDT 2018
 Boot Image: /flash/updated.bin
 Source Commit ID: abde005a31c93734c89444b8aec2b6bb2d2e794d
```

```
show card table
```

Example output:

| Slot   | Card Type                            | Oper State | SPOF | Attach |
|--------|--------------------------------------|------------|------|--------|
| 1: CFC | Control Function Virtual Card        | Active     | No   |        |
| 2: CFC | Control Function Virtual Card        | Standby    | -    |        |
| 3: FC  | 4-Port Service Function Virtual Card | Standby    | -    |        |
| 4: FC  | 4-Port Service Function Virtual Card | Standby    | -    |        |
| 5: FC  | 4-Port Service Function Virtual Card | Standby    | -    |        |
| 6: FC  | 4-Port Service Function Virtual Card | Standby    | -    |        |
| 7: FC  | 4-Port Service Function Virtual Card | Standby    | -    |        |
| 8: FC  | 4-Port Service Function Virtual Card | Standby    | -    |        |
| 9: FC  | 4-Port Service Function Virtual Card | Standby    | -    |        |
| 10: FC | 4-Port Service Function Virtual Card | Standby    | -    |        |

- Run the following Exec mode command to display additional information about the running StarOS build release.

```
show build
```

- Optional.* Verify the operational state of CF and SF VNFCs.



**Note** This step is relevant only for the upgrade of CF and SF VNFCs.

- Repeat the steps in [Verify Zookeeper Database, on page 137](#) and [Verify ESC Database, on page 138](#) sections.

- Log on to the UEM using either the floating IP or from the AutoVNF using the UEM VIP.

```
ssh ubuntu@<vip-addr>
```

Command example:

```
ssh ubuntu@192.168.100.21
```

- Become the *root* user.

```
sudo -i
```

- Collect the UEM orchestration IP address for Zookeeper database connection.

```
#ifconfig
```

```
eth0 Link encap:Ethernet HWaddr fa:16:3e:71:1d:08
 inet addr:192.168.200.12 Bcast:192.168.200.255 Mask:255.255.255.0
```

- Navigate to the `/opt/cisco/usp/packages/zookeeper/<current>/bin` directory.

- Run Zookeeper tool to access the UEM Zookeeper database.

```
zkCli.sh -server <vip-addr>:port_num
```

Command example:

```
zkCli.sh -server 192.168.200.12:2181
```

Make sure there are no outstanding requests between UEM and CF.

- Verify the “state”: “alive” for each of the CFs and SFs using the following commands:

```
get /oper/vnfs/vnf_name/vdus/vdu_name/cf1
get /oper/vnfs/vnf_name/vdus/vdu_name/cf2
get /oper/vnfs/vnf_name/vdus/vdu_name/sf1
get /oper/vnfs/vnf_name/vdus/vdu_name/sf2
```

Command examples:

```
get /oper/vnfs/tb1-autovnf1_vpc-vpc-core/vdus/vdu-cf1/cf1
get /oper/vnfs/tb1-autovnf1_vpc-vpc-core/vdus/vdu-cf1/cf2
get /oper/vnfs/tb1-autovnf1_vpc-vpc-core/vdus/vdu-sf1/sf1
get /oper/vnfs/tb1-autovnf1_vpc-vpc-core/vdus/vdu-sf1/sf2
```

- h. Look for the state Alive in the console output.

```
zk: localhost:2181(CONNECTED) 2] get
/oper/vdus/control-function/BOOT_generic_di-chassis_CF1_1
{"id":"BOOT_generic_di-chassis_CF1_1","state":"alive","vnfcId":"cf-vnfc-di-chassis","uuid":"c4",
"host":"tb5-ultram-osd-compute-2.localdomain","vimId":"523b921c-7266-4fd5-90bb-5157cffc6951",
"cppts":[{"cpid":"di_intf1","state":"alive","subnet":"6102e9b5-8555-41f5-8cdc-0b47d30a6f7a",
"netmask":"255.255.255.0","dhcp":true,"vl":"vl-vnf1-DI-INTERNAL1-CAT","vnfc":"cf-vnfc-di-chassis",
"port_id":"19539aea-edbf-4acf-a57c-af5627d859ea","ip_address":"192.168.10.3",
"mac_address":"fa:16:3e:19:80:ed","network":"0d72f553-5a9c-4904-b3ea-83371a806e23"},
{"cpid":"di_intf2","state":"alive","nicid":1,"subnet":"30002d02-761d-4ccb-8a9e-d6188cdf54a3",
"netmask":"255.255.255.0","dhcp":true,"vl":"vl-vnf1-DI-INTERNAL2-CAT","vnfc":"cf-vnfc-di-chassis",
"port_id":"ff1dale1-ecf3-477d-98b7-398c3c77fc8d","ip_address":"192.168.11.13",
"mac_address":"fa:16:3e:89:88:23","network":"9f109c0a-b1e7-4d90-a746-5de4ab8ef536"},
{"cpid":"orch","state":"alive","nicid":2,"subnet":"729e9dd2-3c75-43eb-988a-769016f2f44c",
"netmask":"255.255.255.0","dhcp":true,"vl":"vl-vnf1-UAS-ORCH-CAT","vnfc":"cf-vnfc-di-chassis",
"port_id":"81370948-f686-4812-820c-20ec5d3d3cdd","ip_address":"172.168.11.17","mac_address":"fa:16:3e:1d:0b:56",
"network":"9a286170-e393-4ba5-abce-147a45fb337a"}, {"cpid":"mgmt","state":"alive","nicid":3,
"subnet":"9778a11b-1714-4e84-4bc2-86c84b111e8e","netmask":"255.255.255.0","dhcp":true,"vl":"vl-vnf1-UAS-MGMT-CAT",
"vnfc":"cf-vnfc-di-chassis","port_id":"6130cbb4-3dd8-4822-af90-50dac98f2f0d",
"ip_address":"172.168.10.17","mac_address":"fa:16:3e:42:92:47","network":"e278b524-e9a9-48c1-a45b-956a8c3ea583"}],
"monitor":true,"vduId":"control-function"}
cZxid = 0x100000051
ctime = Fri May 18 19:04:40 UTC 2018
mZxid = 0x10000024a
mtime = Mon May 21 17:48:19 UTC 2018
pZxid = 0x100000051
cversion = 0
dataVersion = 12
aclVersion = 0
ephemeralOwner = 0x0
dataLength = 1625
numChildren = 0
```



**Note** You can use use CTRL+D to exit the zookeeper CLI.

- i. From the UEM VM as a root user, log on to the `ncs_cli` and check for devices live status.

```
~$ sudo -i
ncs_cli -C -u admin
show devices device device_name live-status
```



Verify that the command output reflects the correct 'state' and 'card-state' of each card.

Example output:

```
show devices device tb1-autovnf1_vpc-vpc-core-cf-nc live-status
```

```
<snip>
```

VNFC REF	STATE	VNFC ID	VDU REF	CARD TYPE	CARD ID	NUMBER OF CORES	CPU UTILIZATION	DISK SPACE	START TIME	UPTIME	NOVA LAUNCH CMD	ID	DATE AND TIME	FROM STATE	TO STATE
----------	-------	---------	---------	-----------	---------	-----------------	-----------------	------------	------------	--------	-----------------	----	---------------	------------	----------

cf1	-	cf1	cf	cf1	1	-	-	-	-	-	-				
-----	---	-----	----	-----	---	---	---	---	---	---	---	--	--	--	--

cf2	-	cf2	cf	cf2	2	-	-	-	-	-	-				
-----	---	-----	----	-----	---	---	---	---	---	---	---	--	--	--	--

sf1	-	sf1	sf	sf1	3	-	-	-	-	-	-				
-----	---	-----	----	-----	---	---	---	---	---	---	---	--	--	--	--

sf2	-	sf2	sf	sf2	4	-	-	-	-	-	-				
-----	---	-----	----	-----	---	---	---	---	---	---	---	--	--	--	--

```
live-status vnfd sj-autovnf-vpc-abc
```

```
version 6.0
```

```
vnfm vim-tenant-name abc
```

```
vnfm tenant-name abc
```

```
vnfm ipaddr 192.168.100.22
```

```
vnfm port 830
```

```
vnfm username ubuntu
```

```
vnfm password "4+HLzhFFzHq66nqtTsc00CfiODYHq1USVmkn1tRelf84byNakWEa9sJ8sY/cwfFME3aG0UaBC\nvvNNAMkuXQI9Ksfu5IiQQ9ViWbbHw16IEFQ="
```

```
virtual-link vl-di-internal1
```

```
auto-vnf-connection-ref di-internal1
```

```
virtual-link vl-management
```

```
auto-vnf-connection-ref management
```

```
virtual-link vl-orchestration
```

```
auto-vnf-connection-ref orchestration
```

```
virtual-link vl-abc-vpc-svc
```

```
auto-vnf-connection-ref sj-autovnf-abc-vpc-svc
```

```
vdu cf
```

```
ssh-keygen false
```

```
vm-image 076c887a-a12c-4a0b-b4d6-b2d213f64b9e
```

```
lifecycle-event-initialization staros_config.txt
```

```
source-url http://192.168.100.9:5000/config/sj-autovnf-vpc-abc/cf/staros_config.txt
```

```

lifecycle-event-initialization staros_param.cfg

source-url http://192.168.100.9:5000/config/sj-autovnf-vpc-abc/cf/staros_param.cfg

ned cisco-staros-nc

user "4+HLzsE1kLJOeufWY0smBWY2LHjOi2WtJdKy/OIux7YHhsNY/
08hnA9/WwWuFD5trHrW3ZHs\nLo4TfiAKqYwxdNKqFYyoTxH2hrLJV5DgwmE="

password "4+HLzsXtCHJ2vsYZD5s0RGtBRY/dHDU1mgHJX7wCt3o1DMtQZqpBLDcNSJumC7n5rnkVxwI1s\
ncJYeCOFLrqpLHXm3xtXyMdtT7WVzvRMtdao="

netconf

port-number 830

card-type control-function

usp-auto-vnf-id sj-autovnf-vpc-abc-cf

vnfc cf-vnfc-ugp

<snip>

```

## Save the Running Configuration

Save the currently running, upgraded configuration prior to rebooting the chassis.

To save the boot configuration:

1. Log on to the VNF using the VIP address fetched in the [Obtain VIP Addresses for AutoVNF, CF, ESC and UEM, on page 134](#).

```
ssh ubuntu@<vip-addr>
```

Command example:

```
ssh ubuntu@192.168.100.38
```

2. *Optional.* Execute the following command in the Exec mode.

```
chassis key value 1234
```

Save config before reload chassis, EVEN IF the same old key value is used.  
Old config scripts will become invalid after reload.



### Important

This step is optional, and needed only if the chassis key is not set.

3. Save the boot configuration in the flash directory.

```
save configuration /flash/system.cfg
```

```
Warning: About to overwrite boot configuration file
Are you sure? [Yes|No]: yes
```

This will update the boot configuration to use the new bin image.

Use the following command to check the boot configuration.

**# show boot**

```
Monday May 21 20:39:57 UTC 2018

boot system priority 8 \
 image /flash/sftp/production.YYYYY.qvpc-di.bin \
 config /flash/sftp/tb5_vnfl_dayN.cfg

boot system priority 9 \
 image /flash/staros.bin \
 config /flash/sftp/tb5_vnfl_dayN.cfg

boot system priority 10 \
 image /flash/staros.bin \
 config /flash/system.cfg
```

4. Enter the configuration mode to change the boot priority of new StarOS bin file.

**#config**

```
#boot system priority 1 image /flash/updated.bin config
/flash/system.cfg
```

**#end**

5. Verify the new boot priority.

**#show boot**

```
boot system priority 1 \
 image /flash/updated.bin \
 config /flash/system.cfg

boot system priority 10 \
 image /flash/staros.bin \
 config /flash/system.cfg
```

6. Verify whether the flash directory contains the boot configuration and new bin.

**dir /flash**

```
total 320376
-rw-rw-r-- 1 root root 134 May 3 10:11 boot.sys
-rw-rw-r-- 1 root root 3920672 May 11 19:49 crashlog2
drwxrwxr-x 2 root root 4096 May 11 19:49 crsh2
-rw-rw-r-- 1 root root 156 May 11 19:49 module.sys
drwxrwxr-x 3 root root 4096 May 11 19:49 patch
drwxrwxr-x 2 root root 4096 May 11 19:49 persistdump
-rw-rw-r-- 1 root root 79 May 11 19:49 restart_file_cntr.txt
drwxrwxr-x 3 root root 4096 May 11 20:07 sftp
-rw-rw-r-- 1 root root 160871936 May 3 10:11 staros.bin
-rw-rw-r-- 1 root root 5199 May 11 19:57 system.cfg
-rw-rw-r-- 1 root root 163227136 May 11 20:07 updated.bin
320476 /flash
Filesystem 1K-blocks Used Available Use% Mounted on
```

```
/var/run/storage/boot1/part2
4112620 320476 3792144 8% /mnt/user/.auto/onboard/flash
```

## Synchronize File Systems

To synchronize the file systems:

1. Log on to the VNF using the VIP address fetched in the [Obtain VIP Addresses for AutoVNF, CF, ESC and UEM, on page 134](#).
2. Synchronize the local file systems on the management cards by entering the following command:

```
[local]host_name# filesystem synchronize all
```

Example output:

```
Updating /flash/system.cfg

Updating /flash/updated.bin

Updating /flash/sftp/yang/cisco-staros-bulkstats-config.yang

Updating /flash/sftp/yang/cisco-staros-bulkstats-schema-types.yang

Updating /flash/sftp/yang/cisco-staros-bulkstats.yang

Updating /flash/sftp/yang/cisco-staros-cli-config.yang

Updating /flash/sftp/yang/cisco-staros-confd-config.yang

Updating /flash/sftp/yang/cisco-staros-config.yang

Updating /flash/sftp/yang/cisco-staros-exec.yang

Updating /flash/sftp/yang/cisco-staros-kpi.yang

Updating /flash/sftp/yang/cisco-staros-notif.yang

Updating /flash/boot.sys
```

```

12 updated on card 2

 /flash/system.cfg

 /flash/updated.bin

 /flash/sftp/yang/cisco-staros-bulkstats-config.yang
 /flash/sftp/yang/cisco-staros-bulkstats-schema-types.yang
 /flash/sftp/yang/cisco-staros-bulkstats.yang
 /flash/sftp/yang/cisco-staros-cli-config.yang
 /flash/sftp/yang/cisco-staros-confd-config.yang
 /flash/sftp/yang/cisco-staros-config.yang
 /flash/sftp/yang/cisco-staros-exec.yang
 /flash/sftp/yang/cisco-staros-kpi.yang
 /flash/sftp/yang/cisco-staros-notif.yang

 /flash/boot.sys

```

## Reboot the System

To reboot the system (VNF):

1. Log on to the VNF using the VIP address fetched in the [Obtain VIP Addresses for AutoVNF, CF, ESC and UEM, on page 134](#).

```
ssh ubuntu@<vip-addr>
```

Command example:

```
ssh ubuntu@192.168.100.38
```

2. Enter the following Exec mode command:

```
[local]host_name# reload [-noconfirm]
```

As the system reboots, it loads the new operating system software image and its corresponding CLI configuration file using the new boot stack entry configured earlier.

3. *Optional for PDSN:* If you are using the IP Pool Sharing Protocol during your upgrade, refer to *Configuring IPSP Before the Software Upgrade* in the *PDSN Administration Guide*.
4. After the reload is complete, log on to the VNF and make sure it is loaded with the intended StarOS version and all the cards have booted up and are in active or stand-by state as expected.

```
show version
```

Example output:

```
Active Software:
 Image Version: 21.9.0.69977
 Image Build Number: 69977
 Image Description: Build
```

```
Image Date: Mon Jul 30 06:48:34 EDT 2018
Boot Image: /flash/updated.bin
Source Commit ID: abde005a31c93734c89444b8aec2b6bb2d2e794d
```

**show card table**

Example output:

Slot	Card Type	Oper State	SPOF	Attach
1: CFC	Control Function Virtual Card	Active	No	
2: CFC	Control Function Virtual Card	Standby	-	
3: FC	4-Port Service Function Virtual Card	Standby	-	
4: FC	4-Port Service Function Virtual Card	Standby	-	
5: FC	4-Port Service Function Virtual Card	Standby	-	
6: FC	4-Port Service Function Virtual Card	Standby	-	
7: FC	4-Port Service Function Virtual Card	Standby	-	
8: FC	4-Port Service Function Virtual Card	Standby	-	
9: FC	4-Port Service Function Virtual Card	Standby	-	
10: FC	4-Port Service Function Virtual Card	Standby	-	

- Run the following Exec mode command to display additional information about the running StarOS build release.

**show build**

- Optional.* Verify the operational state of CF and SF VNFCs.



**Note** This step is relevant only for the upgrade of CF and SF VNFCs.

- Repeat the steps in [Verify Zookeeper Database, on page 137](#) and [Verify ESC Database, on page 138](#) sections.

- Log on to the UEM using either the floating IP or from the AutoVNF using the UEM VIP.

```
ssh ubuntu@<vip-addr>
```

Command example:

```
ssh ubuntu@192.168.100.21
```

- Become the *root* user.

```
sudo -i
```

- Collect the UEM orchestration IP address for Zookeeper database connection.

```
#ifconfig
```

```
eth0 Link encap:Ethernet HWaddr fa:16:3e:71:1d:08
```

```
 inet addr:192.168.200.12 Bcast:192.168.200.255 Mask:255.255.255.0
```

- Navigate to the `/opt/cisco/usp/packages/zookeeper/<current>/bin` directory.

- Run Zookeeper tool to access the UEM Zookeeper database.

```
zkCli.sh -server <vip-addr>:port_num
```

Command example:

```
zkCli.sh -server 192.168.200.12:2181
```

Make sure there are no outstanding requests between UEM and CF.

- g. Verify the “state”: “alive” for each of the CFs and SFs using the following commands:

```
get /oper/vnfs/vnf_name/vdus/vdu_name/cf1
```

```
get /oper/vnfs/vnf_name/vdus/vdu_name/cf2
```

```
get /oper/vnfs/vnf_name/vdus/vdu_name/sf1
```

```
get /oper/vnfs/vnf_name/vdus/vdu_name/sf2
```

Command examples:

```
get /oper/vnfs/tb1-autovnf1_vpc-vpc-core/vdus/vdu-cf1/cf1
```

```
get /oper/vnfs/tb1-autovnf1_vpc-vpc-core/vdus/vdu-cf1/cf2
```

```
get /oper/vnfs/tb1-autovnf1_vpc-vpc-core/vdus/vdu-sf1/sf1
```

```
get /oper/vnfs/tb1-autovnf1_vpc-vpc-core/vdus/vdu-sf1/sf2
```

- h. Look for the state Alive in the console output.

```
zk: localhost:2181 (CONNECTED) 2] get
/oper/vdus/control-function/BOOT_generic_di-chassis_CF1_1
{"id":"BOOT_generic_di-chassis_CF1_1","state":"alive","vnfcId":"cf-vnfc-di-chassis","uuid":"c4",
"host":"tb5-ultram-osd-compute-2.localdomain","vimId":"523b921c-7266-4fd5-90bb-5157cffc6951",
"cpnts":[{"cpid":"di_intf1","state":"alive","subnet":"6102e9b5-8555-41f5-8cdc-0b47d30a6f7a",
"netmask":"255.255.255.0","dhcp":true,"vl":"vl-vnf1-DI-INTERNAL1-CAT","vnfc":"cf-vnfc-di-chassis",
"port_id":"19539aea-edbf-4acf-a57c-af5627d859ea","ip_address":"192.168.10.3",
"mac_address":"fa:16:3e:19:80:ed","network":"0d72f553-5a9c-4904-b3ea-83371a806e23"},
{"cpid":"di_intf2","state":"alive","nicid":1,"subnet":"30002d02-761d-4ccb-8a9e-d6188cdf54a3",
"netmask":"255.255.255.0","dhcp":true,"vl":"vl-vnf1-DI-INTERNAL2-CAT","vnfc":"cf-vnfc-di-chassis",
"port_id":"ff1dale1-ecf3-477d-98b7-398c3c77fc8d","ip_address":"192.168.11.13",
"mac_address":"fa:16:3e:89:88:23","network":"9f109c0a-b1e7-4d90-a746-5de4ab8ef536"},
{"cpid":"orch","state":"alive","nicid":2,"subnet":"729e9dd2-3c75-43eb-988a-769016f2f44c",
"netmask":"255.255.255.0","dhcp":true,"vl":"vl-vnf1-UAS-ORCH-CAT","vnfc":"cf-vnfc-di-chassis",
"port_id":"81370948-f686-4812-820c-20ec5d3d3cdd","ip_address":"172.168.11.17","mac_address":"fa:16:3e:1d:0b:56",
"network":"9a286170-e393-4ba5-abce-147a45fb337a"}, {"cpid":"mgmt","state":"alive","nicid":3,
"subnet":"9778a11b-1714-4e84-bbc2-86c84b111e8e","netmask":"255.255.255.0","dhcp":true,"vl":"vl-vnf1-UAS-MGMT-CAT",
"vnfc":"cf-vnfc-di-chassis","port_id":"6130cbb4-3dd8-4822-af90-50dac98f2f0d",
"ip_address":"172.168.10.17","mac_address":"fa:16:3e:42:92:47","network":"e278b524-e9a9-48c1-a45b-956a8c3ea583"}],
"monitor":true,"vduId":"Control-function"}
cZxid = 0x100000051
ctime = Fri May 18 19:04:40 UTC 2018
mZxid = 0x10000024a
mtime = Mon May 21 17:48:19 UTC 2018
pZxid = 0x100000051
cversion = 0
dataVersion = 12
aclVersion = 0
ephemeralOwner = 0x0
dataLength = 1625
numChildren = 0
```



**Note** You can use use **CTRL+D** to exit the zookeeper CLI.

- i. From the UEM VM as a root user, log on to the *ncs\_cli* and check for devices live status.

```
~$ sudo -i
ncs_cli -C -u admin
show devices device device_name live-status
```

Verify that the command output reflects the correct 'state' and 'card-state' of each card.

Example output:

```
show devices device tb1-autovnf1_vpc-vpc-core-cf-nc live-status
```

<snip>

REF	STATE	NAME	VDU REF	CARD TYPE	CARD SLOT	CARD NUMBER OF CORES	CPU UTILIZATION	DISK SPACE	START TIME	UPTIME	NOVA LAUNCH CMD	ID	DATE AND TIME	FROM AND STATE	TO STATE
cf1	-	cf1	cf	cf1	1	-	-	-	-	-	-	-	-	-	-
cf2	-	cf2	cf	cf1	2	-	-	-	-	-	-	-	-	-	-
sf1	-	sf1	sf	sf1	3	-	-	-	-	-	-	-	-	-	-
sf2	-	sf2	sf	sf1	4	-	-	-	-	-	-	-	-	-	-

```
live-status vnf sj-autovnf-vpc-abc
```

```
version 6.0
vnfm vim-tenant-name abc
vnfm tenant-name abc
vnfm ipaddr 192.168.100.22
vnfm port 830
vnfm username ubuntu
vnfm password "4+HLzhFFzHq66nqtTsc00CfiODYHq1USVmknltRelf84byNakWEa9sJ8sY/cwFME3aG0UaBC\nvvNNAMkuXQI9Ksfu5IiQQ9ViWbbHw16IEFQ="
virtual-link vl-di-internall
 auto-vnf-connection-ref di-internall
virtual-link vl-management
 auto-vnf-connection-ref management
virtual-link vl-orchestration
 auto-vnf-connection-ref orchestration
virtual-link vl-abc-vpc-svc
 auto-vnf-connection-ref sj-autovnf-abc-vpc-svc
vdu cf
ssh-keygen false
```



```

vm-image 076c887a-a12c-4a0b-b4d6-b2d213f64b9e

lifecycle-event-initialization staros_config.txt

source-url http://192.168.100.9:5000/config/sj-autovnf-vpc-abc/cf/staros_config.txt

lifecycle-event-initialization staros_param.cfg

source-url http://192.168.100.9:5000/config/sj-autovnf-vpc-abc/cf/staros_param.cfg

ned cisco-staros-nc

user "4+HLzsElkLJOeufWyoSmBwY2LHjOi2WtJdKy/OIux7YHhsNY/
O8hnA9/WwWuFD5trHrW3ZHs\nLo4TfiAKqYwxdNKqFYyoTxH2hrLJV5DgwmE="

password
"4+HLzsXtCHJ2vsYZD5s0RGtBRY/dHDU1mgHJX7wCt3o1DMtQZqpBLDcNSJumC7n5rnkVxwI1s\
ncJYeCOFLrqpLHXm3xtXyMdtT7WVzvRMtdao="

netconf

port-number 830

card-type control-function

usp-auto-vnf-id sj-autovnf-vpc-abc-cf

vnfc cf-vnfc-ugp

<snip>

```

## Restoring the Previous Software Image

If for some reason you need to undo the upgrade, perform the upgrade again except:

- Specify the locations of the upgrade software image and configuration files.

then

- Specify the locations of the original software image and configuration files.

## Upgrading ICSR Chassis

The procedure for upgrading primary and backup ICSR chassis is described in *Interchassis Session Recovery*. Essentially the procedure requires upgrading the primary and standby chassis using the off-line method while each is in standby mode.

## Performing Dynamic Software Updates

StarOS allows the runtime loading of plugins. All StarOS builds include a "default" baseline plugin.

This feature is currently used to dynamically update the detection logic used to filter P2P applications via the Application Detection and Control (ADC) feature.

Patching is the process used to install a plugin as an incremental update to a StarOS release. One plugin can be provided to multiple, compatible, concurrent product releases. A plugin is distributed in the form of a compressed distribution kit via the internet or by other means (USB stick, CD, etc.).

A plugin is a functional software entity that provides incremental updates to a pre-existing StarOS software component. Plugins have the characteristic of being dynamically loadable at runtime and do not require a system restart. A plugin has a name and one or more versions. All plugin names are known to the system at product release.

For complete information on the Dynamic Software Update process, refer to the *ADC Administration Guide*.

## Managing License Keys

License keys define capacity limits (number of allowed subscriber sessions) and available features on your system. Adding new license keys allows you to increase capacity and add new features as your subscriber base grows.

### New System License Keys

New systems are delivered with no license keys installed. In most cases, you receive the license key in electronic format (usually through e-mail).

When a system boots with no license key installed a default set of restricted session use and feature licenses is installed. The following Exec Mode command lists the license information:

```
[local]host_name# show license information
```



#### Important

With no license key installed, the session use licenses for PDSN, HA, GGSN, and L2TP LNS are limited to 10,000 sessions.

The license keys on the ASR 5500 are stored in EEPROM on the chassis midplane. Both MIO/UMIO/MIO2s access this EEPROM when booting.

### Session Use and Feature Use Licenses

Session use and feature use licenses are software mechanisms that provide session limit controls and enable special features within the system. These electronic licenses are stored in the system's configuration file that is loaded as part of the system software each time the system is powered on or restarted.

- Session use licenses limit the number of concurrent sessions that a system is capable of supporting per service type and are acquired on an as-needed basis. This allows carriers to pay only for what they are using and easily increase capacity as their subscriber base grows.
- Feature use licenses enable specific features/functionality within the system and are distributed based on the total number of sessions supported by the system.

### Installing New License Keys

Use the instructions below to install a new license key.

## Cutting and Pasting the Key

If you have a copy of the license, use the following configuration to cut and paste just the license key part:

**Step 1** From the Exec mode, enter the following:

```
configure
license key license
exit
```

*license* is the license key string. The license can be an alphanumeric string of 1 through 1023 characters that is case sensitive. Copy the license key as shown in the example below, including the \" (double-quote slash). Please note: this is not a functional license.

```
"\
VER=1|C1M=000-0000-00|C1S=03290231803|C2M=11-1111-11-1|C2S=\
STCB21M82003R80411A4|DOI=0000000000|DOE=00000000|ISS=1|NUM=13459|00000000000000|
LSP=000000|LSH=000000|LSG=500000|LSL=500000\|FIS=Y|FR4=Y|FPP=Y|FCS=Y|FTC=Y|FMG=Y|
FCR=Y|FSR=Y|FPM=Y|FID=Y|SIG=MCwCF\Esnq6Bs/
XdmyfLe7rHcD4sVP2bzAhQ3IeHDoyyd6388jHsHD99sg36SG267gshssja77
end
```

**Step 2** Verify that the license key just entered was accepted by entering the following command at the Exec mode prompt:

```
[local]host_name# show license key
```

The new license key should be displayed. If it is not, return to the Global configuration mode and re-enter the key using the **license key** command.

**Important** An invalid license will not be accepted. A Failure error will appear in the output of the **license key** command when you attempt to configure an invalid license key. If you use the **-force** option to install an invalid license key, the license will be placed into a 30-day grace period. StarOS will generate daily syslog error messages and SNMP traps during the grace period. The output of the **show license information** command will indicate "License State" as "Not Valid".

**Step 3** Verify that the license key enabled the correct functionality by entering the following command:

```
[local]host_name# show license information
```

All license keys and the new session capacity or functionality enabled should be listed. If the functionality or session capacity enabled by the new key is incorrect, please contact your service representative.

**Step 4** Save your configuration as described in the *Verifying and Saving Your Configuration* chapter.

**Caution** Failure to save the new license key configuration in the current CLI configuration file will result in the loss of any of the new features enabled by the license key once the system is reloaded.

## Adding License Keys to Configuration Files

License keys can be added to a new or existing configuration file.



**Important** License key information is maintained as part of the CLI configuration. Each time a key is installed or updated, you must re-save the configuration file.

- Step 1** Open the configuration file to which the new license key commands are to be copied.
- Step 2** Copy the license as shown in the example, including the "\" (double-quote slash). Please note: this is not a functional license.

```
"\
VER=1|C1M=000-0000-00|C1S=03290231803|C2M=11-1111-11-1|C2S=\STCB21M82003R80411A4|
DOI=0000000000|DOE=00000000|ISS=1|NUM=13459|0000000000000|LSP=000000|LSH=000000|
LSG=500000|LSL=500000\FIS=Y|FR4=Y|FPP=Y|FCS=Y|FTC=Y|FMG=Y|FCR=Y|FSR=Y|FPM=Y|FID=Y|
SIG=MCwCF\Esnq6Bs/XdmyfLe7rHcD4sVP2bzAhQ3IeHDoyyd6388jHsHD99sg36SG267gshssja77
end
```

- Step 3** Paste the license key into the configuration
- Important** Paste the license key information at the beginning of the configuration file to ensure the system has the expected capacity and features before it configures contexts.
- Step 4** Save your configuration as described in the *Verifying and Saving Your Configuration* chapter.

## License Expiration Behavior

When a license expires, there is a built-in grace period of 30 days that allows normal use of the licensed session use and feature use licenses. This allows you to obtain a new license without any interruption of service.

The following Exec mode command lists the license information including the date the grace period is set to expire:

```
show license information
```

## Requesting License Keys

License keys for the system can be obtained through your Cisco account representative. Specific information is required before a license key may be generated:

- Sales Order or Purchase Order information
- Desired session capacity
- Desired functionality
- Midplane (chassis) serial number

To obtain the ASR 5500 chassis serial number, at the Exec mode prompt enter the **show card hardware 5** command. Look under the "MEC" heading for the "UDI Serial Number" as shown in the example below:

```
MEC:
Description : MEC
Cisco Part Number : 73-14501-01 A0
UDI Serial Number : FLM154300D8
UDI Product ID : ASR55-MEC
UDI Version ID : V01
```

The ICSR license key for Active and Standby chassis are uniquely coded to each chassis. Two separate license keys are required.

## Viewing License Information

To see the license detail, enter the following command from the Exec mode:

```
[local]host_name# show license information [full | key [full]]
```

## Deleting a License Key

Use the procedure below to delete the session and feature use license key from a configuration. You must be a security administrator or administrator.

```
configure
 no license key
 exit
show license key
```

The output of this command should display: "No license key installed".

## Management Card Replacement and License Keys

License keys are stored on a midplane EEPROM in the ASR 5500 chassis. The MIO/UMIO/MIO2s share these license keys. There is no need to swap memory cards into replacement MIO/UMIO/MIO2s.

## Managing Local-User Administrative Accounts

Unlike context-level administrative accounts which are configured via a configuration file, information for local-user administrative accounts is maintained in a separate file in flash memory and managed through the software's Shared Configuration Task (SCT). Because local-user accounts were designed to be compliant with ANSI T1.276-2003, the system provides a number of mechanisms for managing these types of administrative user accounts.

For additional information, see [Disable AAA-based Authentication for Console, on page 68](#) and [Limit local-user Login on Console/vty Lines, on page 69](#).

## Configuring Local-User Password Properties

Local-user account password properties are configured globally and apply to all local-user accounts. The system supports the configuration of the following password properties:

- **Complexity:** Password complexity can be forced to be compliant with ANSI T1.276-2003.
- **History length:** How many previous password versions should be tracked by the system.
- **Maximum age:** How long a user can use the same password.
- **Minimum number of characters to change:** How many characters must be changed in the password during a reset.
- **Minimum change interval:** How often a user can change their password.
- **Minimum length:** The minimum number of characters a valid password must contain.
- **Expiry warning:** Password expiry warning interval in days.

- **Auto-generate:** Automatically generates password with option to specify length of password.

Refer to the **local-user password** command in the *Global Configuration Mode Commands* chapter of the *Command Line Interface Reference* for details on each of the above parameters.

## Configuring Local-User Account Management Properties

Local-user account management includes configuring account lockouts and user suspensions.

### Local-User Account Lockouts

Local-user accounts can be administratively locked for the following reasons:

- **Login failures:** The configured maximum login failure threshold has been reached. Refer to the **local-user max-failed-logins** command in the *Global Configuration Mode Commands* chapter of the *Command Line Interface Reference* for details
- **Password Aging:** The configured maximum password age has been reached. Refer to the **local-user password** command in the *Global Configuration Mode Commands* chapter of the *Command Line Interface Reference* for details.

Accounts that are locked out are inaccessible to the user until either the configured lockout time is reached (refer to the **local-user lockout-time** command in the *Global Configuration Mode Commands* chapter of the *Command Line Interface Reference*) or a security administrator clears the lockout (refer to the **clear local-user** command in the *Exec Mode Commands* chapter of the *Command Line Interface Reference*).



#### Important

Local-user administrative user accounts could be configured to enforce or reject lockouts. Refer to the **local-user username** command in the *Global Configuration Mode Commands* chapter of the *Command Line Interface Reference* for details.

### Local-User Account Suspensions

Local-user accounts can be suspended as follows:

```
configure
suspend local-user name
```

A suspension can be removed by entering:

```
configure
no suspend local-user name
```

## Changing Local-User Passwords

Local-user administrative users can change their passwords using the **password change** command in the Exec mode. Users are prompted to enter their current and new passwords.

Security administrators can reset passwords for local-users by entering the following command from the root prompt in the Exec mode:

```
[local]host_name# password change username name
```

*name* is the name of the local-user account for which the password is to be changed. When a security administrator resets a local-user's password, the system prompts the user to change their password the next time they login.

All new passwords must adhere to the password properties configured for the system.







# CHAPTER 11

## Smart Licensing

- [Feature Summary and Revision History, on page 165](#)
- [Smart Software Licensing, on page 166](#)
- [Configuring Smart Licensing, on page 170](#)
- [Monitoring and Troubleshooting Smart Licensing, on page 171](#)

### Feature Summary and Revision History

#### Summary Data

Applicable Product(s) or Functional Area	All
Applicable Platform(s)	ASR 5500 VPC-SI VPC-DI
Feature Default	Disabled - Configuration Required
Related Changes in This Release	Not Applicable
Related Documentation	<ul style="list-style-type: none"><li>• <i>ASR 5500 System Administration Guide</i></li><li>• <i>Command Line Interface Reference</i></li><li>• <i>VPC-DI System Administration Guide</i></li><li>• <i>VPC-SI System Administration Guide</i></li></ul>

#### Revision History

Revision Details	Release
Added Smart Licensing support for On/Off feature licenses.	21.6
First introduced.	21.3

# Smart Software Licensing

## Overview

StarOS 21.3 and higher releases support Smart Licensing. Smart Licensing is a cloud-based approach to licensing that simplifies the purchase, deployment, and management of Cisco software assets. Entitlements are purchased through your Cisco account via Cisco Commerce Workspace (CCW) and immediately deposited into your Virtual Account for usage. This eliminates the need to install license files on every device. Products that are smart enabled communicate directly to Cisco to report consumption. A single location is available to customers to manage Cisco software licenses—the Cisco Smart Software Manager (CSSM). License ownership and consumption are readily available to help make better purchase decision based on consumption or business need.

See <https://www.cisco.com/c/en/us/buy/smart-accounts/software-licensing.html> for more information about Cisco Smart Licensing.

## Comparison Between Legacy Licensing and Smart Licensing

Cisco employs two types of license models - Legacy Licensing and Smart Software Licensing. **Legacy Licensing** consists of software activation by installing Product Activation Keys (PAK) on to the Cisco product. A Product Activation Key is a purchasable item, ordered in the same manner as other Cisco equipment and used to obtain license files for feature set on Cisco Products. **Smart Software Licensing** is a cloud based licensing of the end-to-end platform through the use of a few tools that authorize and deliver license reporting. Smart Software Licensing functionality incorporated into StarOS complete the product registration, authorization resulting in reporting services available to the end customer.

## Evaluation Period

A 90 day evaluation period is granted for all licenses in use. During this period feature licenses can be used without limitation, and up to one counting license each can be used. The evaluation period ends when the system registers successfully with the CSSM or Cisco.com. Licensed functionality is blocked when this 90 day period expires.

## Smart Licensing in Release 21.6

In Release 21.6 and higher, Smart Licensing supports on/off feature licenses. In previous releases Smart Licensing only supported counting licenses.

StarOS performs license enforcement for on/off feature licenses. Each on/off feature license is tied to service licenses, which potentially use those on/off features. When an Out of Compliance (OOC) is detected for an on/off license, new calls for the corresponding services will be dropped, subject to the following conditions:

- Each on/off feature license is given a 90 day grace (evaluation) period. During this period, the system generates SNMP traps to inform of the unavailability of valid licenses. To resolve the OOC, corrective action is needed such as purchasing and registering licenses for this feature, or disabling the feature.
- If the feature is still OOC after the 90 day grace period, StarOS enforces the OOC state based on a predefined policy for each license. If enforcement is required, new calls for the services corresponding to the on/off licenses are dropped.

Two new commands have been introduced to display details about the enforcement of Smart Licenses in use:

```
show license enforcement policy
show license enforcement status [allowed | blocked] [feature | service
]
```

### Smart Licensing in Release 21.3

When Smart Licensing is enabled in Release 21.3, it operates in mixed mode where both Legacy and Smart Licensing is used.

- Legacy (PAK-based) licenses continue to be used for On/Off features.
- Smart licensing is used for counting each service. In Release 21.3 only the counting licenses listed below in "Entitlement Tags" are controlled by Smart Licensing. All other counting licenses use Legacy (PAK-based) licenses.

## Cisco Smart Software Manager

Cisco Smart Software Manager (CSSM) enables the management of software licenses and Smart Account from a single portal. The interface allows you to activate your product, manage entitlements, and renew and upgrade software. A functioning Smart Account is required to complete the registration process. To access the Cisco Smart Software Manager, see <https://software.cisco.com>.

## Smart Accounts/Virtual Accounts

A Smart Account provides a single location for all Smart-enabled products and entitlements. It helps speed procurement, deployment, and maintenance of Cisco Software. When creating a Smart Account, you must have the authority to represent the requesting organization. After submitting, the request goes through a brief approval process.

A Virtual Account exists as a sub-account within the Smart Account. Virtual Accounts are a customer-defined structure based on organizational layout, business function, geography or any defined hierarchy. They are created and maintained by the Smart Account administrator.

See <https://software.cisco.com> to learn about, set up, or manage Smart Accounts.

## Request a Cisco Smart Account

A Cisco Smart Account is an account where all products enabled for Smart Licensing are deposited. A Cisco Smart Account allows you to manage and activate your licenses to devices, monitor license use, and track Cisco license purchases. Through transparent access, you have a real-time view into your Smart Licensing products. IT administrators can manage licenses and account users within your organization's Smart Account through the Smart Software Manager.

---

**Step 1** In a browser window, enter the following URL:

```
https://software.cisco.com
```

**Step 2** Log in using your credentials, and then click **Request a Smart Account** in the **Administration** area. The **Smart Account Request** window is displayed.

**Step 3** Under **Create Account**, select one of the following options:

- **Yes, I have authority to represent my company and want to create the Smart Account** – If you select this option, you agree to authorization to create and manage product and service entitlements, users, and roles on behalf of your organization.
- **No, the person specified below will create the account** – If you select this option, you must enter the email address of the person who will create the Smart Account.

**Step 4** Under **Account Information**:

- Click **Edit** beside **Account Domain Identifier**.
- In the **Edit Account Identifier** dialog box, enter the domain, and click **OK**. By default, the domain is based on the email address of the person creating the account and must belong to the company that will own this account.
- Enter the **Account Name** (typically, the company name).

**Step 5** Click **Continue**.

The Smart Account request will be in pending status until it has been approved by the Account Domain Identifier. After approval, you will receive an email confirmation with instructions for completing the setup process.

## Software Tags and Entitlement Tags

Tags for the following software and entitlements have been created to identify, report, and enforce licenses.

### Software Tags

Software tags uniquely identify each licenseable software product or product suite on a device. The following software tags exist for the StarOS.

Product Type / Description	Software Tag
ASR5500 ASR-5500 Multimedia Core Platform	regid.2017-02.com.cisco.ASR5500,1.0_401f2e9e-67fd-4131-b61d-6e229d13a338
VPC_SI Virtualized Packet Core (Single instance)	regid.2017-02.com.cisco.VPC_SI,1.0_dcb12293-10c0-4e90-b35e-b10a9f8bfac1
VPC_DI Virtualized Packet Core (Distributed instance)	regid.2017-02.com.cisco.VPC_DI,1.0_5cb68f91-c1d6-48d6-9482-e9750203f5e6

### Entitlement Service Tags

The following entitlement tags identify licenses in use for each service type:

TagId	Service Type / Description	Entitlement Tag
0	ASR5K-00-PW10GTWY PDN GW Bundle, 10K Sessions	regid.2017-02.com.cisco.ASR5K-00-PW10GTWY, 1.0_85a577a1-017d-4dc6-8bf7-4fac7c4d465a
1	ASR5K-00-SG10 SAE GW Bundle, 10K Sessions	regid.2017-02.com.cisco.ASR5K-00-SG10, 1.0_e87d1e76-e34c-4699-94ad-68eafa2da8b2

TagId	Service Type / Description	Entitlement Tag
2	ASR5K-00-GN10SESS GGSN Software License, 10K sessions	regid.2017-02.com.cisco. ASR5K-00-GN10SESS, 1.0_bf7eb1d7-35bf-40c6-8763-a4770f5ebf64
3	ASR5K-00-SW10LIC Serving GW Bundle, 10K Sessions	regid.2017-02.com.cisco. ASR5K-00-SW10LIC, 1.0_ca9d09ee-5e72-4695-97ef-d5117037cfb4
4	ASR5K-00-ME10LIC MME Bundle, 10K sessions	regid.2017-02.com.cisco. ASR5K-00-ME10LIC, 1.0_37a452c9-ff23-41fc-b96c-c8b2eb09254b
5	ASR5K-00-EG10S-K9 EPDG, 10k Sessions	regid.2017-02.com.cisco. ASR5K-00-EG10S-K9, 1.0_5c625d0f-8b2c-4c44-970b-9668a072890f
6	ASR5K-00-SM10S-K9 SaMOG GW 10k Sessions	regid.2017-02.com.cisco. ASR5K-00-SM10S-K9, 1.0_289f4807-fb6e-4750-b047-a9d57e7b045f

### Entitlement Feature Tags

The following entitlement tags identify licenses in use for each feature type:

TagId	Feature / Description	Entitlement Tag
0	ASR5K-00-CS01GRET GRE Interface Tunnelling	regid.2017-11.com.cisco. ASR5K-00-CS01GRET, 1.0_284ba242-a2ef-4ad0-b445-b62ed3887d3b
1	ASR5K-00-CS01MPLS MPLS on StarOS	regid.2017-11.com.cisco. ASR5K-00-CS01MPLS, 1.0_1b1221cd-39de-4113-8709-dad022c0a063
2	ASR5K-00-GN01REC Session Recovery	regid.2017-11.com.cisco. ASR5K-00-GN01REC, 1.0_88542f00-077b-4ed0-9698-a3cec699a047
3	ASR5K-00-GN01ICSR Inter-Chassis Session Recovery	regid.2017-11.com.cisco. ASR5K-00-GN01ICSR, 1.0_d0bca3e3-1218-4e91-98f6-207a20a5401a
4	ASR5K-00-EP01VLE EPC Gw VoLTE enhancements	regid.2017-11.com.cisco. ASR5K-00-EP01VLE, 1.0_a6c3d615-0b37-4f4a-8c34-3090ed5e265c
5	ASR5K-00-EP01ICSE ICSR Enhanced Recovery for Data and Control Plane	regid.2017-11.com.cisco. ASR5K-00-EP01ICSE, 1.0_bf87e837-003e-4832-b29f-ce0416699b01
6	ASR5K-00-PWXICSRP ICSR/SR Performance Improvements	regid.2017-11.com.cisco. ASR5K-00-PWXICSRP, 1.0_079a8bd2-a97d-4d12-bc5a-b0f70eec6c26

TagId	Feature / Description	Entitlement Tag
7	ASR5K-00-CS01I-K9 IPSec on StarOS	regid.2017-11.com.cisco. ASR5K-00-CS01I-K9, 1.0_a6e5539c-ab69-4303-b2a8-e71c03ac2a08
8	ASR5K-00-EG01RS ePDG Reselection	regid.2017-11.com.cisco. ASR5K-00-EG01RS, 1.0_b7f0b7d1-0d68-4223-abb1-381c3ac968ec

## Configuring Smart Licensing

Before you begin, ensure you have:

- Created a Smart Licensing account on <https://software.cisco.com>.
- Registered your products on <https://software.cisco.com> using the Product Instance Registration tokens created as part of Smart Account/Virtual Account.
- Enabled a communication path between the StarOS system to the CSSM server or Cisco.com.

### Enable Smart Licensing

By default, Smart Licensing is disabled in StarOS. To enable Smart Licensing, enter the following Config mode commands:

```
config
 license smart enable
end
```

Enter the following command to verify the configuration:

```
show configuration | grep license
```

### Register the Device with Cisco

Using the id Product Instance Registration token provided when you registered the products on <https://software.cisco.com>, register the system using the following Exec mode command:

```
license smart register idtoken token
```

The system now automatically report entitlement usage count to the CSSM server and receive a compliance status. This also removes the system from "Evaluation Mode".

To show the compliance status, enter any of the following Exec mode commands:

```
show license status
show license summary
show license statistics
```

The registration for the system is renewed automatically every 180 days. If needed, use the following Exec mode command to renew the registration information manually:

```
license smart renew id
```

The license authorization for the system is renewed automatically every 30 days. If needed, use the following Exec mode command to renew the license authorization manually:

```
license smart renew auth
```

To unregister a device, enter the following Exec mode command:

```
license smart deregister
```

### Handling Out of Compliance

If there are not enough licenses in the virtual account for a given SKU, CSSM sends an Out Of Compliance (OOC) message to the device. The system stops allowing additional sessions until the OOC state is cleared. The OOC state is cleared when the device receives an authorized response.

## Monitoring and Troubleshooting Smart Licensing

Enter the following Exec mode command to verify the Smart Licensing configuration:

```
show configuration | grep license
```

The following Exec mode commands display information about Smart Licensing:

```
show license { all | enforcement | eval-period | smart-tags | statistics
| status | summary | tech-support | udi | usage } [| { grep grep_options
| more }]
```

Notes:

- **all** - Shows a superset of information that includes show status, show usage, show UDI, as well as the Smart Licensing agent version.
- **enforcement { policy | status [ allowed | blocked ] [ feature | service ] }** - Shows the enforcement policy applied or current enforcement status of Smart Licenses. Status information can be filtered to show only the licenses which are currently allowed or blocked, or by type (feature license or service license).
- **eval-period** - Shows information about the evaluation period. Licenses are granted a 90 day evaluation period until they are registered.
- **smart-tags [ feature | service ]** - Shows the features and services that are currently supported and the corresponding Smart Entitlement Tag.
- **statistics** - Shows individual feature license status.
- **status** - Shows overall Smart Licensing status information.
- **summary** - Shows summary of Smart Licensing status.
- **tech-support** - Shows information useful for debugging issues with Smart Licensing.
- **udi** - Shows details for all Unique Device Identifiers (UDI).
- **usage** - Shows the usage information for all entitlements that are currently in use.

The following SNMP alarms (traps) are produced to track issues with Smart Licensing.

- 1349: starSmartLicenseServiceOOC / starSmartLicenseServiceOOCclear
- 1350: starSmartLicenseEvalMode / starSmartLicenseEvalModeClear
- 1351: starSmartLicenseEvalModeExpire / starSmartLicenseEvalModeExpireClear

- 1352: starSmartLicenseCSSMConntectionFail / starSmartLicenseCSSMConnectionFailClear



---

**Note** For more information regarding these SNMP MIB alarms, see the *SNMP MIB Reference*.

---

## Smart Licensing Bulk Statistics

The following statistics are provided in support of Smart Licensing

- `current_sl_state` – Current state of Smart Licensing, either enabled or disabled.
- `current_sl_mode` – Current mode of Smart Licensing, either Evaluation or Registered.
- `total_sl_enabled` – Total number of times Smart Licensing has been enabled.
- `total_sl_disabled` – Total number of times Smart Licensing has been disabled.
- `mode` – Counters for each service type when product in Evaluation and Registered mode.
- `tagid` – Tagid for each service type.
- `cur_call_policy` – Current call policy for new sessions of each service type, either ALLOW or BLOCK.
- `cur_call_count` – Current number of sessions/calls counted for the entire product for a particular service type.
- `max_call_count` – Maximum number of sessions/calls counted for the entire product for a particular service type.
- `last_lic_count` – License count last reported to Cisco licensing (CSSM) for particular service type.
- `max_lic_count` – Maximum license count reported to Cisco licensing (CSSM) for particular service type up to this point in time.
- `policy_change_block_calls` – Number of times particular service type blocked new sessions as a result of insufficient licenses available.





# CHAPTER 12

## Monitoring the System

This chapter provides information for monitoring system status and performance using the **show** commands found in the Command Line Interface (CLI). These commands have many related keywords that allow them to provide useful information on all aspects of the system ranging from current software configuration through call activity and status.

The selection of keywords described in this chapter is intended to provide the most useful and in-depth information for monitoring the system. For additional information on these and other **show** command keywords, refer to the *Exec Mode show Commands* chapter of the *Command Line Interface Reference*.



### Important

In Release 21.1 and forward, use the **do show** command to run all Exec Mode **show** commands while in Global Configuration Mode. It is not necessary to exit the Config mode to run a **show** command. The pipe character | is only available if the command is valid in the Exec mode.

- [SNMP Notifications, on page 173](#)
- [Monitoring System Status and Performance, on page 173](#)
- [Monitoring ASR 5500 Hardware Status, on page 175](#)
- [Clearing Statistics and Counters, on page 177](#)

## SNMP Notifications

In addition to the CLI, the system supports Simple Network Management Protocol (SNMP) notifications that indicate status and alarm conditions. Refer to the *SNMP MIB Reference* for a detailed listing of these notifications.

## Monitoring System Status and Performance

This section contains commands used to monitor the status of tasks, managers, applications and other software components in the system. Output descriptions for most of the commands are located in the *Statistics and Counters Reference*.

Table 7: System Status and Performance Monitoring Commands

To do this:	Enter this command:
<b>View Administrative Information</b>	
Display Current Administrative User Access	
View a list of all administrative users currently logged on the system	<b>show administrators</b>
View the context in which the administrative user is working, the IP address from which the administrative user is accessing the CLI, and a system generated ID number	<b>show administrators session id</b>
View information pertaining to local-user administrative accounts configured for the system	<b>show local-user verbose</b>
View statistics for local-user administrative accounts	<b>show local-user statistics verbose</b>
View information pertaining to your CLI session	<b>show cli</b>
<b>Determining System Uptime</b>	
View system uptime (time since last reboot)	<b>show system uptime</b>
<b>View NTP Server Status</b>	
View NTP servers status	<b>show ntp status</b>
<b>View System Resources</b>	
View all system resources such as CPU resources and number of managers created	<b>show resources [ cpu ]</b>
<b>View System Alarms</b>	
View information about all currently outstanding alarms	<b>show alarm outstanding all verbose</b>
View system alarm statistics	<b>show alarm statistics</b>
<b>View Congestion-Control Statistics</b>	
View Congestion-Control Statistics	<b>show congestion-control statistics</b>
<b>View Remote Management Statistics</b>	
View SNMP notification statistics	<b>show snmp notifies</b>
View SNMP access statistics	<b>show snmp accesses</b>
View SNMP trap history	<b>show snmp trap history</b>
View SNMP Trap Statistics	<b>show snmp trap statistics</b>
<b>View Port Counters</b>	
View datalink counters for a specific port	<b>show port datalink counters slot#/port#</b>
View Port Network Processor Unit (NPU) counters for a specific port	<b>show port npu counters slot#/port#</b>
<b>View System Information and Network Interfaces</b>	

To do this:	Enter this command:
View information about system components, storage devices and network interfaces	<b>show hardware</b>
<b>View Card Information and Statistics</b>	
View diagnostics for all cards or for a card in a specific slot/port; (for VPC, slot = VM)	<b>show card diag</b> <i>slot/port</i>
View detailed information for all cards or a card in a specific slot/port (for VPC, slot = VM)	<b>show card info</b> <i>slot/port</i>
View operating status for all cards or VMs	<b>show card table</b>
View the contents of the boot configuration (param.cfg) file [VPC-DI]	<b>show cloud configuration</b>
View information about installed hardware and whether it is optimal or not for a specific card or all cards in the system [VPC-DI]	<b>show cloud hardware</b>
View monitored statistics about the VPC-DI network relative to a specific card [VPC-DI]	<b>show cloud monitor di-network</b>

**Important**

The commands or keywords/variables that are available are dependent on platform type, product version, and installed license(s).

**Important**

Some commands have different outputs depending on the platform type.

## Monitoring ASR 5500 Hardware Status

Use the commands contained in this section to monitor the status of the hardware components in the chassis. For output descriptions for most of the commands, refer to the *Statistics and Counters Reference*.

**Important**

The commands or keywords and variables are dependent on platform type, product version, and installed license(s). Some commands produce different outputs, depending on the platform type.

Table 8: Hardware Monitoring Commands

To do this:	Enter this command:
<b>View the Status of the Power System</b>	
View the status of the PFUs	<b>show power chassis</b>
View the power status of the individual chassis slots	<b>show power all</b>
<b>View the Status of the Fan Trays</b>	
View the status of the fan trays, including current relative speeds and temperatures.	<b>show fans</b>
<b>Determine the Status of Installed Cards</b>	
View a listing of installed application cards	<b>show card table</b>
<b>Perform a Hardware Inventory</b>	
View all cards installed in the chassis and their hardware revision, part, serial, assembly, and fabrication numbers	<b>show hardware inventory</b>
View details of a specific card. Output contains same information as output of both show hardware inventory and show hardware version board	<b>show hardware card</b> <i>slot_number</i>
<b>View Card Diagnostics</b>	
View boot, power and temperature diagnostics	<b>show card diag</b> <i>slot_number</i>
View runtime, or real time, information	<b>show card info</b> <i>slot_number</i>
<b>View the LED Status of All Installed Cards</b>	
<b>Note</b> Refer to the descriptions of card-level and system-level LEDs in the <i>ASR 5500 Installation Guide</i> for detailed information.	
View the LED status for all installed cards	<b>show leds all</b>
<b>View Available Physical Ports</b>	
View ports that are available to the system	<b>show port table</b>
View detailed information for a specific port	<b>show port info</b> <i>slot_number/port_number</i>
<b>View CPU Resource Information</b>	
View CPU resources	<b>show resources { cpu   session }</b>
View CPU usage information	<b>show cpu table; show cpu info</b>
<b>View Component Temperature Information</b>	
View current component temperatures	<b>show temperature</b>
View maximum temperatures reached since last timestamp.	<b>show maximum-temperatures</b>

## Clearing Statistics and Counters

It may be necessary to periodically clear statistics and counters in order to gather new information. The system provides the ability to clear statistics and counters based on their grouping (PPP, MIPHA, MIPFA, etc.).

Statistics and counters can be cleared using the CLI **clear** command. Refer to the *Exec Mode Commands* chapter of the *Command Line Interface Reference* for detailed information on using this command.





# CHAPTER 13

## Monitor Process Listing

- [Feature Summary and Revision History, on page 179](#)
- [Feature Description, on page 180](#)
- [Monitoring and Troubleshooting, on page 180](#)

## Feature Summary and Revision History

### Summary Data

Applicable Product(s) or Functional Area	All
Applicable Platform(s)	<ul style="list-style-type: none"><li>• ASR 5500</li><li>• VPC-DI</li><li>• VPC-SI</li></ul>
Feature Default	Enabled - Always-on
Related Changes in This Release	Not applicable
Related Documentation	<ul style="list-style-type: none"><li>• <i>ASR 5500 System Administration Guide</i></li><li>• <i>Command Line Interface Reference</i></li><li>• <i>Statistics and Counters Reference</i></li><li>• <i>VPC-DI System Administration Guide</i></li><li>• <i>VPC-SI System Administration Guide</i></li></ul>

### Revision History



#### Important

Revision history details are not provided for features introduced before releases 21.2 and N5.1.

Revision Details	Release
First introduced.	21.11

## Feature Description

The Monitor Process Listing feature supports the following functionalities:

- Viewing the running processes to check and detect intrusion.
- Checking the software to detect if it is tamper-proof.
- Enabling security decisions.

The newly introduced CLI command, **show process status**, supports this feature.

## Monitoring and Troubleshooting

This section provides information regarding the CLI command available in support of monitoring and troubleshooting the feature.

### Show Command(s) and/or Outputs

This section provides information regarding the show command and/or its output in support of this feature.

#### show process status

The output of this CLI command now includes the following fields in support of this feature:

- card - cpu
  - USER
  - PID
  - PPID
  - STARTED
  - %CPU
  - %MEM
  - COMMAND




---

**Note** Only the Security Administrator can run this command.

---





# CHAPTER 14

## Bulk Statistics

This chapter provides configuration information for:

- [Feature Summary and Revision History](#), on page 181
- [Configuring Communication with the Collection Server](#), on page 182
- [Viewing Collected Bulk Statistics Data](#), on page 186
- [Collecting Bulk Statistics Samples in SSD](#), on page 186
- [Manually Gathering and Transferring Bulk Statistics](#), on page 186
- [Clearing Bulk Statistics Counters and Information](#), on page 187
- [Bulkstats Schema Nomenclature](#), on page 187
- [Bulk Statistics Event Log Messages](#), on page 190

## Feature Summary and Revision History

### Summary Data

Applicable Product(s) or Functional Area	All
Applicable Platform(s)	ASR 5500 VPC-DI VPC-SI
Feature Default	Disabled - Configuration Required
Related Changes in This Release	Not Applicable
Related Documentation	<ul style="list-style-type: none"> <li>• <i>ASR 5500 System Administration Guide</i></li> <li>• <i>Command Line Interface Reference</i></li> <li>• <i>VPC-DI System Administration Guide</i></li> <li>• <i>VPC-SI System Administration Guide</i></li> </ul>

## Revision History



**Note** Revision history details are not provided for features introduced before releases 21.2 and N5.5.

Revision Details	Release
<p>New functionality was added to replace or supplement the configured bulkstats schema with the option of preserving bulkstats configuration parameters.</p> <p>New functionality was added to collect bulkstats samples in the SSD. Refer to <a href="#">Collecting Bulk Statistics Samples in SSD, on page 186</a> for more information.</p> <p>The <b>bulkstat</b> Global Configuration Mode command added the <b>config [ schema   supplement ]</b> keywords to enable this functionality. Refer to <a href="#">Configuring a Separate Bulkstats Config File, on page 183</a> for more information.</p> <p><b>show configuration bulkstats brief</b> command output was expanded to include all bulkstats configuration details except for schema.</p>	21.3
First introduced.	Pre 21.2

# Configuring Communication with the Collection Server

Two configuration methods are available for defining how bulk statistics are collected and managed. A "standard" configuration allows the system to automatically assign a number to the bulk statistics file. Optionally, a number can be specified by an administrator in the optional configuration method. Command details and descriptions of keywords and variables for commands in this chapter are located in the *Bulk Statistics Configuration Mode Commands* and *Bulk Statistics File Configuration Mode Commands* chapters in the *Command Line Interface Reference*.

## Configuring Standard Settings

The configuration example in this section defines basic operation of the bulk statistics feature. Use the following example configuration to set up the system to communicate with the statistic collection server:

```
configure
 bulkstats mode
 schema name format format_string
 sample-interval time_interval
 transfer-interval xmit_time_interval
 limit mem_limit
 exit
 bulkstats collection
end
```

## Configuring Optional Settings

This section describes optional commands that can be used within the Bulk Statistics Configuration mode. Specifically, you can configure bulk statistic "files" under which to group the bulk statistics. "Files" are used to group bulk statistic schema, delivery options, and receiver configuration. Because multiple "files" can be configured, this functionality provides greater flexibility because it allows you to configure different schemas to go to different receivers.

```

configure
 bulkstats mode
 file number
 receiver ip_address { primary | secondary }
 [mechanism { { { ftp | sftp } login user_name
 [encrypted] password pwd } | tftp } }] }
 receiver mode { redundant | secondary-on-failure }
 remotefile format naming_convention [both-receivers | primary-receiver
| secondary-receiver]
 header format header_format
 footer format footer_format
 exit
 schema_type schema format format_string
 sample-interval time_interval
 transfer-interval xmit_time_interval
 limit mem_limit
 exit
 bulkstats collection
 end

```



### Important

In release 20.0 and higher Trusted StarOS builds, FTP is not supported. SFTP is the recommended transfer protocol.

## Configuring Bulk Statistic Schemas

In each configuration example described in [Configuring Standard Settings, on page 182](#) and [Configuring Optional Settings, on page 183](#), the following is the primary command used to configure the type of schema and the statistics collected:

```

configure
 bulkstats mode
 schema_type schema format format_string

```

Refer to the *Bulk Statistics Configuration Mode Commands* and *Bulk Statistics File Configuration Mode Commands* chapters in the *Command Line Interface Reference* for more information regarding supported schemas, available statistics, and proper command syntax.

## Configuring a Separate Bulkstats Config File

You can configure a separate destination file for storing the bulk statistics sub-mode configuration. Run the **show configuration bulkstats** command to confirm the configuration.

The bulkstats configuration file stores the configuration that was previously stored in the system configuration file under the bulk statistics sub-mode.

The Global Configuration mode **bulkstats config** command creates the separate configuration file in the system configuration.

#### configure

```
[no] bulkstats config [schema | supplement] url
```

```
end
```

The optional **schema** keyword allows you to replace only the schema using the file provided and preserve the server configuration. The optional **supplement** keyword allows you to supplement the running bulkstats configuration with the contents of the configuration file provided. These keywords only work on existing files.

*url* specifies the location of the bulkstats configuration file. If the destination file already exists, it is replaced with the new file (except when the **schema** or **supplement** keywords are used). The new file will only be created if you save the configuration after completing changes. The Exec mode **show configuration bulkstats** command displays the URL for the bulkstats configuration mode destination file if it has been configured.

You can copy the bulkstats configuration file from the *url*, edit it and copy it back to /flash. Changes can be applied by using the **no** form of the **bulkstats config** command followed by reconfiguring the **bulkstats config** command.

When the **bulkstats config** command is enabled, StarOS removes the existing bulk statistics sub-mode configuration from the system configuration file. You must save the system configuration to retain the configuration change.

If **no bulkstats config** is used to disable the new destination file after it has been enabled. StarOS does not remove the file. You must save the system configuration to retain the configuration change.



#### Important

---

After completing changes to the bulk statistics configuration, you must save the system configuration to save the changes. If the **bulkstats config** command is enabled, the bulkstats configuration file will be updated.

---

## Using show bulkstats Commands

There are several Exec mode **show bulkstats** commands that display information about defined parameters.

- **show bulkstats data** – displays criteria contained in the statistics gathering scheme for up to four files. See [Viewing Collected Bulk Statistics Data, on page 186](#).
- **show bulkstats schemas** – displays the scheme used to gather statistics including collection and transmission statistics. See [Verifying Your Configuration, on page 185](#).
- **show bulkstats variables** – displays available bulkstat variables (*%variable%*) by schema type that can be incorporated into a schema format.

In addition, **show configuration bulkstats brief** displays the bulkstats configuration at a global scope, as well as all server configuration. It does not display the schema configuration.

## Verifying Your Configuration

After configuring support for bulk statistics on the system, you can check your settings prior to saving them.

Follow the instructions in this section to verify your bulk statistic settings. These instructions assume that you are at the root prompt for the Exec mode.

Check your collection server communication and schema settings by entering the following Exec mode command:

```
show bulkstats schemas
```

The following is an example command output:

```
Bulk Statistics Server Configuration:
 Server State: Enabled
 File Limit: 6000 KB
 Sample Interval: 15 minutes (0D 0H 15M)
 Transfer Interval: 480 minutes (0D 0H 15M)
 Collection Mode: Cumulative
 Receiver Mode: Secondary-on-failure
 Local File Storage: None

Bulk Statistics Server Statistics:
 Records awaiting transmission: 114
 Bytes awaiting transmission: 8092
 Total records collected: 59926
 Total bytes collected: 4190178
 Total records transmitted: 59812
 Total bytes transmitted: 4188512
 Total records discarded: 0
 Total bytes discarded: 0
 Last collection time required: 2 second(s)
 Last transfer time required: 0 second(s)
 Last successful transfer: Wednesday December 7 12:14:30 EDT 2011
 Last successful tx recs: 190
 Last successful tx bytes: 13507
 Last attempted transfer: Wednesday December 7 12:14:30 EDT 2011

File 1
 Remote File Format: /users/ems/server/data/chicago/bulkstat%date%%time%.txt
 File Header: "CHI_test %time%"
 File Footer: ""

Bulkstats Receivers:
 Primary: 192.168.0.100 using FTP with username administrator
 Records awaiting transmission: 0
 Bytes awaiting transmission: 0
 Total records collected: 0
 Total bytes collected: 0
 Total records transmitted: 0
 Total bytes transmitted: 0
 Total records discarded: 0
 Total bytes discarded: 0
 Last transfer time required: 0 second(s)
 No successful data transfers
 No attempted data transfe

File 2 not configured

File 3 not configured

File 4 not configured
```

## Saving Your Configuration

Save the configuration as described in the *Verifying and Saving Your Configuration* chapter.

## Viewing Collected Bulk Statistics Data

The system provides a mechanism for viewing data that has been collected but has not been transferred. This data is referred to as "pending data".

View pending bulk statistics data per schema by entering the following Exec mode command:

```
show bulkstats data
```

The above command also shows the statistics of remote files, if configured as described in [Configuring Optional Settings](#), on page 183.

## Collecting Bulk Statistics Samples in SSD

The output of the show support details (SSD) command is collected and provided to the Technical Assistance Center (TAC) for troubleshooting purposes. Bulkstats information in the SSD enables customers to provide readily available bulk statistics records for analysis, and faster resolution to issues.

By default, the system does not include bulkstats samples in the SSD. This functionality can be enabled using the **bulkstats ssd-samples** command under the Global Configuration Mode.

```
config
 bulkstats ssd-samples { 1 | 2 }
end
```

If previously enabled, the { **no** | **default** } **bulkstats ssd-samples** command disables collection of bulkstats samples in the SSD archive. Each bulkstats sample contains bulkstats from one transfer history. Currently, a maximum of two bulkstats sample can be included in the SSD archive. The sample files are collected in a temporary storage location at `/var/tmp/bulkstats` under the file name `ssd_bulkstats_file<bulkstat_file_number>_sample1.txt` (and `ssd_bulkstats_file<bulkstat_file_number>_sample2.txt`).

While the SSD archive is being created in the temporary storage, the bulk statistics samples might occupy a large amount of the storage space. As a result, the SSD archive creation might fail. During such scenarios, the **no-bulkstats** keyword in the **show support details** command can exclude the bulkstats samples from the SSD archive.

## Manually Gathering and Transferring Bulk Statistics

There may be times where it is necessary to gather and transfer bulk statistics outside of the scheduled intervals. The system provides commands that allow you to manually initiate the gathering and transferring of bulk statistics.

To manually initiate the gathering of bulk statistics outside of the configured sampling interval, enter the following Exec mode command:

```
bulkstats force gather
```

To manually initiate the transferring of bulk statistics prior to reaching the of the maximum configured storage limit, enter the following Exec mode command:

```
bulkstats force transfer
```

## Clearing Bulk Statistics Counters and Information

It may be necessary to periodically clear counters pertaining to bulk statistics in order to gather new information or to remove bulk statistics information that has already been collected. The following Exec mode command can be used to perform either of these functions:

```
clear bulkstats { counters | data }
```

The **clear bulkstats data** command clears any accumulated data that has not been transferred. This includes any "completed" files that have not been successfully transferred.

## Bulkstats Schema Nomenclature

This section describes the nomenclature associated with configuring and viewing bulkstats.

### Statistic Types

The following statistic types are defined in the *Statistics and Counters Reference* user document (published prior to Release 20.0) and displayed in the output of the Exec mode **show bulkstats variables** command"

- **Counter:** A counter records incremental data cumulatively and rolls over when the counter limit is reached.
  - All counter statistics are cumulative and reset only by one of the following methods: roll-over when the limit is reached, after a system restart, or after a clear command is performed.
  - The limit depends upon the data type.
- **Gauge:** A gauge statistic indicates a single value; a snapshot representation of a single point in time within a defined time frame. The gauge changes to a new value with each snapshot though a value may repeat from one period to the next. The limit depends upon the data type.
- **Information:** This type of statistic provides information, often intended to differentiate sets of statistics; for example, a VPN name or IP address. The type of information provided depends upon the data type.

The following statistic types are included in the *Statistics and Counters Reference* spreadsheet published after release 20.0 to replace the original user document:

- **Incremental:** An incremental data type records incremental data cumulatively and rolls over when the counter limit is reached.
  - All incremental statistics are cumulative and reset only by one of the following methods: roll-over when the limit is reached, after a system restart, or after a clear command is performed.
  - The limit depends upon the data type.

- **Gauge:** A gauge statistic indicates a single value; a snapshot representation of a single point in time within a defined time frame. The gauge changes to a new value with each snapshot though a value may repeat from one period to the next. The limit depends upon the data type.
- **Primary-key:** This type of statistic provides information, often intended to differentiate sets of statistics; for example, a VPN name or IP address. The type of information provided depends upon the data type.

## Data Types

The data type defines the format of the data for the value provided by the statistic. The following data types appear in the *Statistics and Counters Reference* and the output of the Exec mode **show bulkstats variables** command:

- **Int32:** A 32-bit integer; the roll-over to zero limit is 4,294,967,295.
- **Int64:** A 64-bit integer; the roll-over to zero limit is 18,446,744,073,709,551,615.
- **Float:** A numeric value that includes decimal points; for example, 1.345.
- **String:** A series of ASCII alphanumeric characters in a single grouping, usually pre-configured.

## Key Variables

Every schema has some variables which are typically referred to as "key variables". These key variables provide index markers to identify to which object the statistics apply. For example, in the card schema the card number (variable %card%) uniquely identifies a card. For an HA service, the keys would be "%vpnname%" plus "%servname%", as the combination uniquely identifies an HA service. So, in a given measurement interval, one row of statistics will be generated per unique key.

There are also a number of common variables shared across schema that identify time, date, place, etc. These common variables are identified in the table below.

**Table 9: Common Variables Across Schema**

Variables	Description	Statistic Type	Data Type
version-no	Contains complete version information that can be used in the header of the bulkstats file	Information	String
uptime	The total uptime (in seconds) of the system that created the file.	Information	Int32
host	The system hostname that created the file.	Information	String
ipaddr	The default management (local context) IP address in dPv4 dotted-decimal format. An empty string is inserted if no address is available.	Information	String



Variables	Description	Statistic Type	Data Type
date	The UTC date that the collection file was created in YYYYMMDD format where YYYY represents the year, MM represents the month and DD represents the day.	Information	String
date3	The UTC date that the collection file was created in YYMMDD format where YY represents the year, MM represents the month and DD represents the day.	Information	String
time	The UTC time that the collection file was created in HHMMSS format where HH represents the hours, MM represents the minutes, and SS represents the seconds.	Information	String
time2	The UTC time that the collection file was created in HH:MM:SS format where HH represents the hours, MM represents the minutes, and SS represents the seconds.	Information	String
time3	The UTC time that the collection file was created in HH:MM format where HH represents the hours, MM represents the minutes.	Information	String
epochtime	The number of seconds since Jan 1, 1970, 00:00:00 GMT.	Information	In32
schemas	Lists all bulkstat schemas available on this platform.	Information	String
schemas-delta	Lists all bulkstats schemas that have changed the schema list was last output.	Information	String
localdate	The date (adjusted for the local timezone) that the collection file was created in YYYYMMDD format where YYYY represents the year, MM represents the month and DD represents the day.	Information	String

Variables	Description	Statistic Type	Data Type
localdate3	The date that the collection file was created in YYYYMMDD format where YYYY represents the year, MM represents the month and DD represents the day. The date displays in local time, not UTC.	Information	String
localtime	The time (adjusted for the local timezone) that the collection file was created in HHMMSS format where HH represents the hours, MM represents the minutes, and SS represents the seconds.	Information	String
localtime2	The time (adjusted for the local timezone) that the collection file was created in HH:MM:SS format where HH represents the hours, MM represents the minutes, and SS represents the seconds.	Information	String
localtime3	The time that the collection file was created in HH:MM:SS format where HH represents the hours, MM represents the minutes, and SS represents the seconds. The time displays in local time, not UTC.	Information	String
localtz	The local timezone set for this platform.	Information	String
localzoffset	The offset from UTC/GMT for the local timezone. Format = "+" or "-" HHMM.	Information	String
swbuild	The build number of the StarOS version.	Information	String

## Bulk Statistics Event Log Messages

The stat logging facility captures several events that can be useful for diagnosing errors that could occur with either the creation or writing of a bulk statistic data set to a particular location.

The following table displays information pertaining to these events.

**Table 10: Logging Events Pertaining to Bulk Statistics**

<b>Event</b>	<b>Event ID</b>	<b>Severity</b>	<b>Additional Information</b>
Local File Open Error	31002	Warning	"Unable to open local file <i>filename</i> for storing bulkstats data"
Receiver Open Error	31018	Warning	"Unable to open url <i>filename</i> for storing bulkstats data"
Receiver Write Error	31019	Warning	"Unable to write to url <i>filename</i> while storing bulkstats data"
Receiver Close Error	31020	Warning	"Unable to close url <i>filename</i> while storing bulkstats data"





# CHAPTER 15

## System Logs

This chapter describes how to configure parameters related to the various types of logging and how to viewing their content. It includes the following sections:

- [Feature Summary and Revision History, on page 193](#)
- [System Log Types, on page 194](#)
- [Configuring Event Logging Parameters, on page 195](#)
- [Configuring Active Logs, on page 200](#)
- [Specifying Facilities, on page 201](#)
- [Configuring Trace Logging, on page 210](#)
- [Configuring Monitor Logs, on page 210](#)
- [Viewing Logging Configuration and Statistics, on page 211](#)
- [Viewing Event Logs Using the CLI, on page 212](#)
- [Configuring and Viewing Crash Logs, on page 212](#)
- [Reducing Excessive Event Logging, on page 215](#)
- [Checkpointing Logs, on page 216](#)
- [Saving Log Files, on page 217](#)
- [Event ID Overview, on page 217](#)

## Feature Summary and Revision History

### Summary Data

Applicable Product(s) or Functional Area	All
Applicable Platform(s)	<ul style="list-style-type: none"><li>• ASR 5500</li><li>• UGP</li><li>• VPC-DI</li><li>• VPC-SI</li></ul>
Feature Default	Enabled
Related Changes in This Release:	Not Applicable

Related Documentation	<ul style="list-style-type: none"> <li>• <i>ASR 5500 System Administration Guide</i></li> <li>• <i>Command Line Interface Reference</i></li> <li>• <i>VPC-DI System Administration Guide</i></li> <li>• <i>VPC-SI System Administration Guide</i></li> </ul>
-----------------------	--------------------------------------------------------------------------------------------------------------------------------------------------------------------------------------------------------------------------------------------------------------

### Revision History



**Note** Revision history details are not provided for features introduced before releases 21.2 and N5.5.

Revision Details	Release
<p>The Syslog client within StarOS has been updated in this release to support RFC5424 and the syslog messaging standards defined within this standard. StarOS continues to support the previous RFC3164 message formats. In this release, you can also configure multiple syslog server IP addresses with multiple ports.</p> <p><b>Note</b> Release 21.6 supports transport layer messaging with UDP only. TLS and TCP are not supported in this release.</p>	21.6
<p>Two new critical CLI event logs and two new SNMP Traps are added to provide notification if an administrator disables logging entirely for an Event ID or Event ID range, or changes the logging level below default logging level (error level). These event logs and traps are enabled by default in this release, and cannot be disabled. Refer to <a href="#">Global Configuration Mode Filtering, on page 198</a> for more information.</p> <p>No commands have been added or modified as a result of this feature.</p> <p>The <b>show snmp trap statistics</b> command output was expanded to show details in the event that logging events have been disabled or logging level has been changed below the default (error) logging level.</p>	21.3
First introduced.	Pre 21.2

## System Log Types

There are five types of logs that can be configured and viewed on the system:



### Important

Not all Event Logs can be configured on all products. Configurability depends on the hardware platform and licenses in use.

- **Event:** Event logging can be used to determine system status and capture important information pertaining to protocols and tasks in use by the system. This is a global function that will be applied to all contexts, sessions, and processes.

- **Active:** Active logs are operator configurable on a CLI instance-by-CLI instance basis. Active logs configured by an administrative user in one CLI instance cannot be viewed by an administrative user in a different CLI instance. Each active log can be configured with filter and display properties that are independent of those configured globally for the system. Active logs are displayed in real time as events are generated.
- **Trace:** Trace logging can be used to quickly isolate issues that may arise for a particular connected subscriber session. Traces can be taken for a specific call identification (callid) number, IP address, mobile station identification (MSID) number, or username.
- **Monitor:** Monitor logging records all activity associated with a particular session. This functionality is available in order to comply with law enforcement agency requirements for monitoring capabilities of particular subscribers. Monitors can be performed based on a subscriber's MSID or username.
- **Crash:** Crash logging stores useful information pertaining to system software crashes. This information is useful in determining the cause of the crash.

**Important**

---

Stateful Firewall and NAT supports logging of various messages on screen if logging is enabled for firewall. These logs provide detailed messages at various levels, like critical, error, warning, and debug. Stateful Firewall and NAT attack logs also provide information on the source IP address, destination IP address, protocol, or attack type for any packet dropped due to an attack and are also sent to a syslog server if configured in the system. For more information on logging support for Stateful Firewall and NAT, see the *Logging Support* chapter of *PSF Administration Guide* or *NAT Administration Guide*.

---

## Configuring Event Logging Parameters

The system can be configured to generate logs based on user-defined filters. The filters specify the facilities (system tasks or protocols) that the system is to monitor and severity levels at which to trigger the generation of the event entries.

Event logs are stored in system memory and can be viewed via the CLI. There are two memory buffers that store event logging information. The first buffer stores the active log information. The second buffer stores inactive logging information. The inactive buffer is used as a temporary repository to allow you to view logs without having data be overwritten. Logs are copied to the inactive buffer only through manual intervention.

Each buffer can store up to 50,000 events. Once these buffers reach their capacity, the oldest information is removed to make room for the newest.

To prevent the loss of log data, the system can be configured to transmit logs to a syslog server over a network interface.

**Important**

---

For releases after 15.0 MR4, TACACS+ accounting (CLI event logging) will not be generated for Lawful Intercept users (priv-level 15 and 13).

---

## Configuring Event Log Filters

You can filter the contents of event logs at the Exec mode and Global Configuration mode levels. For additional information, see the *Command Line Interface Reference*.

### Exec Mode Filtering

These commands allow you to limit the amount of data contained in logs without changing global logging parameters.

Follow the examples below to filter logs via Exec mode commands.

#### Active Filtering

```
logging active [copy runtime filters] [event-verbosity event_level] [
pdu-data format] [pdu-verbosity pdu_level]
```

Notes:

- **copy runtime filters** – Copies the runtime filters and uses that copy to filter the current logging session.
- **event-verbosity event\_level** – Specifies the level of verbosity to use in logging of events as one of:
  - *min* – Displays minimal information about the event. Information includes event name, facility, event ID, severity level, date, and time.
  - *concise* – Displays detailed information about the event, but does not provide the event source within the system.
  - *full* – Displays detailed information about event, including source information, identifying where within the system the event was generated.
- **pdu-data format** – Specifies output format for packet data units when logged as one of:
  - *none* – raw format (unformatted).
  - *hex* – hexadecimal format
  - *hex-ascii* – hexadecimal and ASCII similar to a main-frame dump
- **pdu-verbosity pdu\_level** – Specifies the level of verbosity to use in logging of packet data units as an integer from 1 through 5, where 5 is the most detailed.

Save the configuration as described in the *Verifying and Saving Your Configuration* chapter.

#### Disable or Enable Filtering by Instance(s)

```
logging filter active facility facility_level severity_level [critical-info |
no-critical-info]
```

```
logging filter { disable | enable } facility facility { all | instance
instance_number }
```

Notes:

- **active** – Indicates that only active processes are to have logging options set.



- **disable** – Disables logging for a specific instance or all instances. This keyword is only supported for aaamgr, hamgr and sessmgr facilities.
- **enable** – Enables logging for a specific instance or all instances. This keyword is only supported for aaamgr, hamgr and sessmgr facilities. By default logging is enabled for all instances of aaamgr, hamgr and sessmgr.
- **facility** *facility* and **level** *severity\_level* – Configure the logging filter that determines which system facilities should be logged and at what levels. For detailed information, see [Specifying Facilities, on page 201](#) and [Event Severities, on page 227](#).
- **all** | **instance** *instance\_number* – Specifies whether logging will be disabled or enabled for all instances or a specific instance of aaamgr, hamgr or sessmgr. Run the **show session subsystem facility** *facility* command to identify specific instance numbers.




---

**Note** These keywords are only supported with the **disable** and **enable** keywords.

---

- **level** *severity\_level* – Specifies the level of information to be logged from the following list which is ordered from highest to lowest:
  - critical - display critical events
  - error - display error events and all events with a higher severity level
  - warning - display warning events and all events with a higher severity level
  - unusual - display unusual events and all events with a higher severity level
  - info - display info events and all events with a higher severity level
  - trace - display trace events and all events with a higher severity level
  - debug - display all events




---

**Note** This keyword is only supported in conjunction with the **active** keyword.

---

- **critical-info** – Specifies that events with a category attribute of critical information are to be displayed. Examples of these types of events can be seen at bootup when system processes and tasks are being initiated. This is the default setting.
- **no-critical-info** – Specifies that events with a category attribute of critical information are not to be displayed.




---

**Note** These keywords are only supported in conjunction with the **active** keyword.

---

**Important**

To enable logging of a single instance of a facility, you must first disable all instances of the facility (**logging filter disable facility *facility* all**) and then enable logging of the specific instance (**logging filter enable facility *facility* instance *instance\_number***). To restore default behavior you must re-enable logging of all instances (**logging filter enable facility *facility* all**).

You can display the instance numbers for enabled instances per facility using the Exec mode **show instance-logging** command.

## Global Configuration Mode Filtering

You can filter the contents of event logs at the Exec mode and Global Configuration mode levels.

Follow the example below to configure run time event logging parameters for the system:

```
configure
logging filter runtime facility facility level report_level
logging display { event-verbosity | pdu-data | pdu-verbosity }
end
```

Notes:

- **facility *facility*** and **level *severity\_level*** – Configure the logging filter that determines which system facilities should be logged and at what levels. For detailed information, see [Specifying Facilities, on page 201](#) and [Event Severities, on page 227](#).
- Repeat for every facility that you would like to log.
- *Optional*: Configure event ID restrictions by adding the **logging disable eventid** command. The system provides the ability to restrict the sending of a specific event ID or a range of event IDs to minimize the amount of data logged to that which is most useful. Repeat to disable logging for additional event IDs or event ID ranges.
- If an administrator restricts event logging for an Event ID or Event ID range using the above command (**logging disable eventid**), the system will generate a Critical Event log "cli 30999 critical" as well as an SNMP trap "1361 (DisabledEventIDs)" with the specific Event IDs or Event ID range that was disabled.

These event logs and traps are enabled by default in this release, and cannot be disabled.

- If an administrator lowers the logging level (using the **logging filter runtime facility *facility* level *report\_level*** command below the default level of "error", the system will generate a Critical Event log "cli 30998 critical" as well as an SNMP trap "1362 (LogLevelChanged)" with the specific Event IDs or Event ID range that was disabled.

These event logs and traps are enabled by default in this release, and cannot be disabled.

The following examples show the CLI output of the traps generated when event logging or logging levels are changed.

```
[local]host# show snmp trap statistics
SNMP Notification Statistics:
...
Trap Name #Gen #Disc Disable Last Generated

...
DisabledEventIDs 1 0 0 2017:05:11:15:35:25
LogLevelChanged 2 0 0 2017:05:11:15:28:03
```

```
[local]host# show snmp trap history
There are x historical trap records (5000 maximum)

Timestamp Trap Information

...
Thu May 11 15:28:03 2017 Internal trap notification 1362 (LogLevelChanged) Logging level
of facility resmgr is changed to critical by user #initial-config# context local privilege
level Security Administrator ttyname /dev/pts/0 address type IPV4 remote ip address 0.0.0.0
...
Thu May 11 15:35:25 2017 Internal trap notification 1361 (DisabledEventIDs) Event IDs from
100 to 1000 have been disabled by user adminuser context context privilege level security
administrator ttyname tty address type IPV4 remote ip address 1.2.3.4
...
Mon May 15 10:14:56 2017 Internal trap notification 1362 (LogLevelChanged) Logging level
of facility sitmain is changed to critical by user staradmin context local privilege level
Security Administrator ttyname /dev/pts/1 address type IPV4 remote ip address 161.44.190.27
```

Save the configuration as described in the *Verifying and Saving Your Configuration* chapter.

## Configuring Syslog Servers

### Syslog Architecture

System Logging (syslog) is the architecture which produces and sends event information from StarOS over the UDP transport layer to a centralized Event Message Collector. Syslog uses a client-server architecture:

- **Syslog Client:** A set of processes running on StarOS products which operate as the sending device for event messages.
- **Syslog Server:** An external server configured to receive the event messages sent from StarOS products.

StarOS products transport event messages using the Syslog Protocol without expecting acknowledgement of receipt. The system forwards event messages regardless if a Syslog Server is available to receive the messages.

### Configuring the System to Sent Event Messages to an External Syslog Server

Information generated by the run time event logging filters can be transmitted to a syslog server for permanent storage.



#### Important

The data transmitted to the Syslog server is meant to be used for informational purposes. Functions such as billing and performance monitoring should not be based on syslogs.



#### Important

Although the system provides the flexibility to configure syslog servers on a context-by-context basis, it is recommended that all servers be configured in the *local* context in order to isolate the log traffic from the network traffic.

Use the following example to configure syslog servers:

```
configure
 context local
 logging syslog ip_address
 end
```

Notes:

- *ip\_address* specifies the IP address of a system log server on the network in IPv4 dotted-decimal or IPv6 colon-separated-hexadecimal notation.
- Several optional keywords are available for the **logging syslog** command. Refer to the *Context Configuration Mode Commands* chapter in the *Command Line Interface Reference* for more information.
- Repeat as necessary to configure additional syslog servers. There is no limit to the number of syslog servers that can be configured.

Refer to the **logging** command in the *Command Line Reference, Modes C-D* for more information.

Save the configuration as described in the *Verifying and Saving Your Configuration* chapter.

## Configuring Active Logs

Active logs are event logs that are operator configurable on a CLI instance-by-CLI instance basis. Active logs configured by an administrative user in one CLI instance are not displayed to an administrative user in a different CLI instance. Each active log can be configured with filter and display properties that are independent of those configured globally for the system. Active logs are displayed in real time as they are generated.

Active logs are not written to the active memory buffer by default. To write active logs to the active memory buffer execute the following command in the Global Configuration mode:

```
[local]host_name(config)# logging runtime buffer store all-events
```

When active logs are written to the active memory buffer, they are available to all users in all CLI instances.

Use the following example to configure active logging in Global Configuration mode:

```
[local]host_name(config)# logging filter runtime facility facility level report_level
```

Notes:

- Configure the logging filter that determines which system facilities should be logged and at what levels. For detailed information, see [Specifying Facilities, on page 201](#) and [Event Severities, on page 227](#).
- Repeat for every facility that you would like to log.
- *Optional:* Configure event ID restrictions by adding the **logging disable eventid** command. The system provides the ability to restrict the sending of a specific event ID or a range of event IDs to minimize the amount of data logged to that which is most useful. Repeat to disable logging for additional event IDs or event ID ranges.
- A number of keyword options/variables are available for the Exec mode **logging active** command. Refer to the *Exec Mode Commands* chapter in the *Command Line Interface Reference* for more information.

Once all of the necessary information has been gathered, the Active log display can be stopped by entering the following command in the Exec mode:

```
no logging active
```

# Specifying Facilities

**Important**

The actual facilities available for logging vary by platform type, StarOS version and installed product licenses.

The following facilities can be configured for logging event data:

- **a10**: A10 interface facility
- **a11**: A11 interface facility
- **a11mgr**: A11 Manager facility
- **aaa-client**: Authentication, Authorization and Accounting (AAA) client facility
- **aaamgr**: AAA manager logging facility
- **aaaproxy**: AAA Proxy facility
- **aal2**: ATM Adaptation Layer 2 (AAL2) protocol logging facility
- **acl-log**: Access Control List (ACL) logging facility
- **acsctrl**: Active Charging Service (ACS) Controller facility
- **acsmgr**: ACS Manager facility
- **afctrl**: Fabric Controller facility [ASR 5500 only]
- **afmgr**: Fabric Manager logging facility [ASR 5500 only]
- **alarmctrl**: Alarm Controller facility
- **alcap**: Access Link Control Application Part (ALCAP) protocol logging facility
- **alcapmgr**: ALCAP manager logging facility
- **all**: All facilities
- **bfd**: Bidirectional Forwarding Detection (BFD) protocol logging facility
- **bgp**: Border Gateway Protocol (BGP) facility
- **bindmux**: IPCF BindMux-Demux Manager logging facility
- **bngmgr**: Broadband Network Gateway (BNG) Demux Manager logging facility
- **bssap+**: Base Station Sub-system Application Part+ protocol facility for the login interface between the SGSN and the MSC/VLR (2.5G and 3G)
- **bssgp**: Base Station Sub-system GPRS Protocol logging facility handles exchange information between the SGSN and the BSS (2.5G only)
- **callhome**: Call Home application logging facility
- **cap**: CAMEL Application Part (CAP) logging facility for protocol used in prepaid applications (2.5G and 3G)

- **cbsmgr**: Cell Broadcasting Service (CBS) logging facility [HNBGW]
- **cdf**: Charging Data Function (CDF) logging facility
- **cfctrl**: Content filtering controller logging facility
- **cfmgr**: Content filtering manager logging facility
- **cgw**: Converged Access Gateway (CGW) logging facility
- **cli**: Command Line Interface (CLI) logging facility
- **cmp**: Certificate Management Protocol (IPSec) logging facility
- **confdmgr**: ConfD Manager proctlet (NETCONF) logging facility
- **connectedapps**: SecGW ASR 9000 oneP communication proctlet
- **connproxy**: Controller Proxy logging facility
- **credit-control**: Credit Control (CC) facility
- **csp**: Card/Slot/Port controller facility
- **css**: Content Service Selection (CSS) facility
- **css-sig**: CSS RADIUS Signaling facility
- **cx-diameter**: Cx Diameter Messages facility [CSCF <--> HSS]
- **data-mgr**: Data Manager Framework logging facility
- **dcardctrl**: IPSec Daughter Card Controller logging facility
- **dcardmgr**: IPSec Daughter Card Manager logging facility
- **demuxmgr**: Demux Manager API facility
- **dgmbmgr**: Diameter Gmb Application Manager logging facility
- **dhcp**: Dynamic Host Configuration Protocol (DHCP) logging facility
- **dhcpv6**: DHCPv6
- **dhost**: Distributed Host logging facility
- **diabase**: Diabase messages facility
- **diactrl**: Diameter Controller proctlet logging facility
- **diameter**: Diameter endpoint logging facility
- **diameter-acct**: Diameter Accounting
- **diameter-auth**: Diameter Authentication
- **diameter-dns**: Diameter DNS subsystem
- **diameter-ecs**: ACS Diameter signaling facility
- **diameter-engine**: Diameter version2 engine logging facility
- **diameter-hdd**: Diameter Horizontal Directional Drilling (HDD) Interface facility

- **diameter-svc**: Diameter Service
- **diamproxy**: DiamProxy logging facility
- **doulosuemgr**: Doulos (IMS-IPSec-Tool) user equipment manager
- **dpath**: IPSec Data Path logging facility
- **drvctrl**: Driver Controller logging facility
- **eap-diameter**: Extensible Authentication Protocol (EAP) IP Security facility
- **eap-ipsec**: Extensible Authentication Protocol (EAP) IPSec facility
- **eap-sta-s6a-s13-s6b-diameter**: EAP/STA/S6A/S13/S6B Diameter messages facility
- **ecs-css**: ACSMGR <-> Session Manager Signalling Interface facility
- **egtpc**: eGTP-C logging facility
- **egtpmgr**: enhanced GPRS Tunneling Protocol (eGTP) manager logging facility
- **egtpu**: eGTP-U logging facility
- **embms**: evolved Multimedia Broadcast Multicast Services Gateway facility
- **embms**: eMBMS Gateway Demux facility
- **epdg**: evolved Packet Data (ePDG) gateway logging facility
- **event-notif**: Event Notification Interface logging facility
- **evlog**: Event log facility
- **famgr**: Foreign Agent manager logging facility
- **firewall**: Firewall logging facility
- **fng**: Femto Network Gateway (FNG) logging facility
- **gbmgr**: SGSN Gb Interface Manager facility
- **gmm**:
  - For 2.5G: Logs the GPRS Mobility Management (GMM) layer (above LLC layer)
  - For 3G: Logs the access application layer (above the RANAP layer)
- **gprs-app**: GPRS Application logging facility
- **gprs-ns**: GPRS Network Service Protocol (layer between SGSN and the BSS) logging facility
- **gq-rx-tx-diameter**: Gq/Rx/Tx Diameter messages facility
- **gss-gcdr**: GTP Storage Server GCDR facility
- **gtpc**: GTP-C protocol logging facility
- **gtpcmgr**: GTP-C protocol manager logging facility
- **gtpp**: GTP-prime protocol logging facility

- **gtpu**: GTP-U protocol logging facility
- **gtpumgr**: GTP-U Demux manager
- **gx-ty-diameter**: Gx/Ty Diameter messages facility
- **gy-diameter**: Gy Diameter messages facility
- **h248prt**: H.248 port manager facility
- **hamgr**: Home Agent manager logging facility
- **hat**: High Availability Task (HAT) process facility
- **hdctrl**: HD Controller logging facility
- **henbapp**: Home Evolved NodeB (HENB) App facility (Do not use this keyword for HENB-GW in Release 20)
- **henbgw**: HENB-GW facility (Do not use this keyword for HENB-GW in Release 20)
- **henbgw-pws**: HENB-GW Public Warning System logging facility (Do not use this keyword for HENB-GW in Release 20)
- **henbgw-sctp-acs**: HENB-GW access Stream Control Transmission Protocol (SCTP) facility (Do not use this keyword for HENB-GW in Release 20)
- **henbgw-sctp-nw**: HENBGW network SCTP facility (Do not use this keyword for HENB-GW in Release 20)
- **henbgwdemux**: HENB-GW Demux facility (Do not use this keyword for HENB-GW in Release 20)
- **henbgwmgr**: HENB-GW Manager facility (Do not use this keyword for HENB-GW in Release 20)
- **hnb-gw**: HNB-GW (3G Femto GW) logging facility (Do not use this keyword for HNB-GW in Release 20)
- **hnbmgr**: HNB-GW Demux Manager logging facility (Do not use this keyword for HNB-GW in Release 20)
- **hss-peer-service**: Home Subscriber Server (HSS) Peer Service facility
- **iftask**: Internal Forwarder Task (Intel DPDK) used on VPC-SI and VPC-DI platforms
- **igmp**: Internet Group Management Protocol (IGMP)
- **ikev2**: Internet Key Exchange version 2 (IKEv2)
- **ims-authorizatn**: IP Multimedia Subsystem (IMS) Authorization Service facility
- **ims-sh**: HSS Diameter Sh Interface Service facility
- **imsimgr**: SGSN IMSI Manager facility
- **imsue**: IMS User Equipment (IMSUE) facility
- **ip-arp**: IP Address Resolution Protocol facility
- **ip-interface**: IP interface facility
- **ip-route**: IP route facility



- **ipms**: Intelligent Packet Monitoring System (IPMS) logging facility
- **ipne**: IP Network Enabler (IPNE) facility
- **ipsec**: IP Security logging facility
- **ipsecdemux**: IPSec demux logging facility
- **ipsg**: IP Service Gateway interface logging facility
- **ipsgmgr**: IP Services Gateway facility
- **ipsp**: IP Pool Sharing Protocol logging facility
- **kvstore**: Key/Value Store (KVSTORE) Store facility
- **l2tp-control**: Layer 2 Tunneling Protocol (L2TP) control logging facility
- **l2tp-data**: L2TP data logging facility
- **l2tpdemux**: L2TP Demux Manager logging facility
- **l2tpmgr**: L2TP Manager logging facility
- **lagmgr**: Link Aggregation Group (LAG) manager logging facility
- **lcs**: Location Services (LCS) logging facility
- **ldap**: Lightweight Directory Access Protocol (LDAP) messages logging facility
- **li**: Refer to the *Lawful Intercept Configuration Guide* for a description of this command.
- **linkmgr**: SGSN/BSS SS7 Link Manager logging facility (2.5G only)
- **llc**: Logical Link Control (LLC) Protocol logging facility; for SGSN: logs the LLC layer between the GMM and the BSSGP layers for logical links between the MS and the SGSN
- **local-policy**: Local Policy Service facility
- **location-service**: Location Services facility
- **m3ap**: M3 Application Protocol facility
- **m3ua**: M3UA Protocol logging facility
- **magmgr**: Mobile Access Gateway manager logging facility
- **map**: Mobile Application Part (MAP) protocol logging facility
- **megadiammgr**: MegaDiameter Manager (SLF Service) logging facility
- **mme-app**: Mobility Management Entity (MME) Application logging facility
- **mme-embms**: MME evolved Multimedia Broadcast Multicast Service facility
- **mme-misc**: MME miscellaneous logging facility
- **mmedemux**: MME Demux Manager logging facility
- **mmemgr**: MME Manager facility
- **mmgr**: Master Manager logging facility

- **mobile-ip**: Mobile IP processes
- **mobile-ip-data**: Mobile IP data facility
- **mobile-ipv6**: Mobile IPv6 logging facility
- **mpls**: Multiprotocol Label Switching (MPLS) protocol logging facility
- **mrme**: Multi Radio Mobility Entity (MRME) logging facility
- **mseg-app**: Mobile Services Edge Gateway (MSEG) application logging facility (This option is not supported in this release.)
- **mseg-gtpc**: MSEG GTP-C application logging facility (This option is not supported in this release.)
- **mseg-gtpu**: MSEG GTP-U application logging facility (This option is not supported in this release.)
- **msegmgr**: MSEG Demux Manager logging facility (This option is not supported in this release.)
- **mtp2**: Message Transfer Part 2 (MTP2) Service logging facility
- **mtp3**: Message Transfer Part 3 (MTP3) Protocol logging facility
- **multicast-proxy**: Multicast Proxy logging facility
- **nas**: Non-Access Stratum (NAS) protocol logging facility [MME 4G]
- **netwstrg**: Network Storage facility
- **npuctrl**: Network Processor Unit Control facility
- **npudrv**: Network Processor Unit Driver facility [ASR 5500 only]
- **npumgr**: Network Processor Unit Manager facility
- **npumgr-acl**: NPUMGR ACL logging facility
- **npumgr-drv**: NPUMGR DRV logging facility
- **npumgr-flow**: NPUMGR FLOW logging facility
- **npumgr-fwd**: NPUMGR FWD logging facility
- **npumgr-init**: NPUMGR INIT logging facility
- **npumgr-lc**: NPUMGR LC logging facility
- **npumgr-port**: NPUMGR PORT logging facility
- **npumgr-recovery**: NPUMGR RECOVERY logging facility
- **npumgr-rri**: NPUMGR RRI (Reverse Route Injection) logging facility
- **npumgr-vpn**: NPUMGR VPN logging facility
- **npusim**: NPUSIM logging facility [ASR 5500 only]
- **ntfy-intf**: Notification Interface logging facility [Release 12.0 and earlier versions only]
- **ocsp**: Online Certificate Status Protocol logging facility.
- **orbs**: Object Request Broker System logging facility

- **ospf**: OSPF protocol logging facility
- **ospfv3**: OSPFv3 protocol logging facility
- **p2p**: Peer-to-Peer Detection logging facility
- **pagingmgr**: PAGINGMGR logging facility
- **pccmgr**: Intelligent Policy Control Function (IPCF) Policy Charging and Control (PCC) Manager library
- **pdg**: Packet Data Gateway (PDG) logging facility
- **pdgdmgr**: PDG Demux Manager logging facility
- **pdif**: Packet Data Interworking Function (PDIF) logging facility
- **pgw**: Packet Data Network Gateway (PGW) logging facility
- **pmm-app**: Packet Mobility Management (PMM) application logging facility
- **ppp**: Point-To-Point Protocol (PPP) link and packet facilities
- **pppoe**: PPP over Ethernet logging facility
- **proclat-map-frwk**: Proclat mapping framework logging facility
- **push**: VPNMGR CDR push logging facility
- **radius-acct**: RADIUS accounting logging facility
- **radius-auth**: RADIUS authentication logging facility
- **radius-coa**: RADIUS change of authorization and radius disconnect
- **ranap**: Radio Access Network Application Part (RANAP) Protocol facility logging info flow between SGSN and RNS (3G)
- **rcr**: Recovery Control Task logging facility
- **rdt**: Redirect Task logging facility
- **resmgr**: Resource Manager logging facility
- **rf-diameter**: Diameter Rf interface messages facility
- **rip**: Routing Information Protocol (RIP) logging facility [RIP is not supported at this time.]
- **rlf**: Rate Limiting Function (RLF) logging facility
- **rohc**: Robust Header Compression (RoHC) facility
- **rsvp**: Reservation Protocol logging facility
- **rua**: RANAP User Adaptation (RUA) [3G Femto GW - RUA messages] logging facility
- **s102**: S102 protocol logging facility
- **s102mgr**: S102Mgr logging facility
- **s1ap**: S1 Application Protocol (S1AP) Protocol logging facility
- **sabp**: Service Area Broadcast Protocol (SABP) logging facility

- **saegw**: System Architecture Evolution (SAE) Gateway facility
- **sbc**: SBc protocol logging facility
- **sccp**: Signalling Connection Control Part (SCCP) Protocol logging (connection-oriented messages between RANAP and TCAP layers).
- **sct**: Shared Configuration Task logging facility
- **setp**: Stream Control Transmission Protocol (SCTP) Protocol logging facility
- **sef\_ecs**: Severely Errored Frames (SEF) APIs printing facility
- **sess-gr**: SM GR facility
- **sessctrl**: Session Controller logging facility
- **sessmgr**: Session Manager logging facility
- **sesstrc**: session trace logging facility
- **sft**: Switch Fabric Task logging facility
- **sgs**: SGs interface protocol logging facility
- **sgsn-app**: SGSN-APP logging various SGSN "glue" interfaces (for example, between PMM, MAP, GPRS-FSM, SMS).
- **sgsn-failures**: SGSN call failures (attach/activate rejects) logging facility (2.5G)
- **sgsn-gtpc**: SGSN GTP-C Protocol logging control messages between the SGSN and the GGSN
- **sgsn-gtpu**: SGSN GTP-U Protocol logging user data messages between the SGSN and GGSN
- **sgsn-mbms-bearer**: SGSN Multimedia Broadcast/Multicast Service (MBMS) Bearer app (SMGR) logging facility
- **sgsn-misc**: Used by stack manager to log binding and removing between layers
- **sgsn-system**: SGSN System Components logging facility (used infrequently)
- **sgsn-test**: SGSN Tests logging facility; used infrequently
- **sgtpcmgr**: SGSN GTP-C Manager logging information exchange through SGTPC and the GGSN
- **sgw**: Serving Gateway facility
- **sh-diameter**: Sh Diameter messages facility
- **sitmain**: System Initialization Task main logging facility
- **slmgr**: Smart Licensing manager logging facility
- **sls**: Service Level Specification (SLS) protocol logging facility
- **sm-app**: SM Protocol logging facility
- **sms**: Short Message Service (SMS) logging messages between the MS and the SMSC
- **sndcp**: Sub Network Dependent Convergence Protocol (SNDTCP) logging facility
- **snmp**: SNMP logging facility

- **sprmgr**: IPCF Subscriber Policy Register (SPR) manager logging facility
- **srdb**: Static Rating Database
- **srp**: Service Redundancy Protocol (SRP) logging facility
- **sscfnni**: Service-Specific Coordination Function for Signaling at the Network Node Interface (SSCF-NNI) logging facility
- **sscop**: Service-Specific Connection-Oriented Protocol (SSCOP) logging facility
- **ssh-ipsec**: Secure Shell (SSH) IP Security logging facility
- **ssl**: Secure Socket Layer (SSL) message logging facility
- **stat**: Statistics logging facility
- **supserv**: Supplementary Services logging facility [H.323]
- **system**: System logging facility
- **tacacsplus**: TACACS+ Protocol logging facility
- **tcap**: TCAP Protocol logging facility
- **testctrl**: Test Controller logging facility
- **testmgr**: Test Manager logging facility
- **threshold**: threshold logging facility
- **ttg**: Tunnel Termination Gateway (TTG) logging facility
- **tucl**: TCP/UDP Convergence Layer (TUCL) logging facility
- **udr**: User Data Record (UDR) facility (used with the Charging Service)
- **user-data**: User data logging facility
- **user-l3tunnel**: User Layer 3 tunnel logging facility
- **usertcp-stack**: User TCP Stack
- **vim**: Voice Instant Messaging (VIM) logging facility
- **vinfo**: VINFO logging facility
- **vmgctrl**: Virtual Media Gateway (VMG) controller facility
- **vmgctrl**: VMG Content Manager facility
- **vpn**: Virtual Private Network logging facility
- **vpp**: Vector Packet Processing (VPP) logging facility
- **wimax-data**: WiMAX DATA
- **wimax-r6**: WiMAX R6
- **wsg**: Wireless Security Gateway (ASR 9000 Security Gateway)
- **x2gw-app**: X2GW (X2 proxy Gateway, eNodeB) application logging facility

- **x2gw-demux**: X2GW demux task logging facility

## Configuring Trace Logging

Trace logging is useful for quickly resolving issues for specific sessions that are currently active. They are temporary filters that are generated based on a qualifier that is independent of the global event log filter configured using the **logging filter** command in the Exec mode. Like event logs, however, the information generated by the logs is stored in the active memory buffer.

All debug level events associated with the selected call are stored.



### Important

Trace logs impact session processing. They should be implemented for debug purposes only.

Use the following example to configure trace logs in the Exec mode:

```
[local]host_name# logging trace { callid call_id | ipaddr ip_address | msid ms_id
| username username }
```

Once all of the necessary information has been gathered, the trace log can be deleted by entering the following command:

```
[local]host_name# no logging trace { callid call_id | ipaddr ip_address | msid
ms_id | username username }
```

## Configuring Monitor Logs

Monitor logging records all activity associated with all of a particular subscriber's sessions. This functionality is available in compliance with law enforcement agency requirements for monitoring capabilities of particular subscribers.

Monitors can be performed based on a subscriber's MSID or username, and are only intended to be used for finite periods of time as dictated by the law enforcement agency. Therefore, they should be terminated immediately after the required monitoring period.

This section provides instructions for enabling and disabling monitor logs.

### Enabling Monitor Logs

Use the following example to configure monitor log targets:

```
configure
 logging monitor { ip_addr | ipv6_addr | msid id | username name }
end
```

Repeat to configure additional monitor log targets.

### Disabling Monitor Logs

Use the following example to disable monitor logs:

```
configure
 no logging monitor { ip_addr | ipv6_addr | msid id | username name }
end
```

## Viewing Logging Configuration and Statistics

Logging configuration and statistics can be verified by entering the following command from the Exec mode:

```
[local]host_name# show logging [active | verbose]
```

When no keyword is specified, the global filter configuration is displayed as well as information about any other type of logging that is enabled.

The following table provides information and descriptions of the statistics that are displayed when the **verbose** keyword is used.

**Table 11: Logging Configuration and Statistics Commands**

Field	Description
<b>General Logging Statistics</b>	
Total events received	Displays the total number of events generated by the system.
Number of applications receiving events	Displays the number of applications receiving the events.
<b>Logging Source Statistics</b>	
Event sequence ids by process	Displays a list of system processes that have generated events and the reference identification number of the event that was generated.
Msg backlog stat with total cnt	Displays the number of event messages that have been back logged in comparison to the total number of events generated.
LS L2 filter drop rate	Displays the percentage of logging source (LS) layer 2 (L2) event drops.
Abnormal Log Source Statistics	Displays abnormal logging source (LS) statistics, if any.
<b>Runtime Logging Buffer Statistics</b>	
Active buffer	Displays the number of events currently logged in the active memory buffer and a timestamp for the oldest and most recent entries in the buffer.
Inactive buffer	Displays the number of events currently logged in the inactive memory buffer.

## Viewing Event Logs Using the CLI

Event logs generated by the system can be viewed in one of the following ways:

- **From the syslog server:** If the system is configured to send logs to a syslog server, the logs can be viewed directly on the syslog server.
- **From the system CLI:** Logs stored in the system memory buffers can be viewed directly from the CLI.
- **From the console port:** By default, the system automatically displays events over the console interface to a terminal provided that there is no CLI session active.

This section provides instructions for viewing event logs using the CLI. These instructions assume that you are at the root prompt for the Exec mode.

---

**Step 1** Copy the active log memory buffer to the inactive log memory buffer.

When the active log memory buffer is copied to the inactive log memory buffer existing information in the inactive log memory buffer is deleted.

Both active and inactive event log memory buffers can be viewed using the CLI in Exec mode. However, it is preferable to view the inactive log in order to prevent any data from being over-written. The information from the active log buffer can be copied to the inactive log buffer by entering the following command:

```
[local]host_name# logs checkpoint
```

**Step 2** View the logs by entering the following command:

```
[local]host_name# show logs
```

A number of optional keywords/variables are available for the **show logs** command. Refer to the *Exec Mode Show Commands* chapter in the *Command Line Interface Reference* for more information.

---

## Configuring and Viewing Crash Logs

In the unlikely even of a software crash, the system stores information that could be useful in determining the reason for the crash. This information can be maintained in system memory or it can be transferred and stored on a network server.

The system supports the generation of the following two types of logs:

- **Crash log:** Crash logs record all possible information pertaining to a software crash (full core dump). Due to their size, they can not be stored in system memory. Therefore, these logs are only generated if the system is configured with a Universal Resource Locator (URL) pointing to a local device or a network server where the log can be stored.
- **Abridged crash log:** Crash event records are automatically generated when a software crash occurs and are stored in flash memory on management cards. The abridged crash log contains a list crash event records along with associated dump files. This log allows you to view event records and dump files via CLI commands.



## Crash Logging Architecture

The crash log is a persistent repository of crash event information. Each event is numbered and contains text associated with a CPU (minicore), NPU or kernel crash. The logged events are recorded into fixed length records and stored in `/flash/crashlog2`.

Whenever a crash occurs, the following crash information is stored:

1. The event record is stored in `/flash/crashlog2` file (the crash log).
2. The associated minicore, NPU or kernel dump file is stored in the `/flash/crsh2` directory.
3. A full core dump is stored in a user configured directory.



### Important

The `crashlog2` file along with associated minicore, NPU and kernel dumps are automatically synchronized across redundant management cards (SMC, MIO/UMIO). Full core dumps are not synchronized across management cards.

The following behaviors apply to the crash logging process.

- When a crash event arrives on an active management card, the event record is stored in its `crashlog2` file along with the minicore, NPU, or kernel dump file in `/flash/crsh2`. The crash event and dump file are also automatically stored in the same locations on the standby management card.
- When a crash log entry is deleted via CLI command, it is deleted on both the active and standby management cards.
- When a management card is added or replaced, active and standby cards will automatically synchronize crash logs and dump files.
- When a crash event is received and the crash log file is full, the oldest entry in the crash log and its related dump file will be replaced with the latest arrived event and dump file on both management cards. Information for a maximum of 120 crash events can be stored on management cards.
- Duplicate crash events bump the count of hits in the existing record and update the new record with the old crash record. Additions to the count use the timestamp for the first time the event happened.

## Configuring Software Crash Log Destinations

The system can be configured to store software crash log information to any of the following locations:

- On the ASR 5500:
  - **Flash memory:** Installed on the active MIO/UMIO [abridged crash log and associated dump files only]
  - **USB memory stick:** Installed in the USB slot on the active MIO/UMIO
- On VPC
  - **Flash memory:** Accessible by the virtual machine
  - **USB memory stick:** Installed in the USB slot of the platform (USB slot has been enabled via the hypervisor)

- **Network Server:** Any workstation or server on the network that the system can access using the Trivial File Transfer Protocol (TFTP), the File Transfer Protocol (FTP), the Secure File Transfer Protocol (SFTP), or the Hyper-Text Transfer Protocol (HTTP); this is recommended for large network deployments in which multiple systems require the same configuration




---

**Important** In release 20.0 and higher Trusted StarOS builds, FTP is not supported.

---

Crash log files (full core dumps) are written with unique names as they occur to the specified location. The name format is *crash-card-cpu-time-core*. Where *card* is the card slot, *cpu* is the number of the CPU on the card, and *time* is the Portable Operating System Interface (POSIX) timestamp in hexadecimal notation.

Use the following example to configure a software crash log destination in the Global Configuration mode:

**configure**

```
crash enable [encrypted] url crash_url
end
```

Notes:

- Refer to the *Global Configuration Mode Commands* chapter in the *Command Line Interface Reference* for more information on this command.
- Repeat to configure additional software crash log destinations. There is no limit to the number of destinations that can be configured.

Save the configuration as described in the *Verifying and Saving Your Configuration* chapter.

## Viewing Abridged Crash Log Information Using the CLI

You can view abridged crash information that is stored as a set of event records in flash memory on management cards (**/flash/crashlog2**). Each crash event record has an associated dump file (minicore, NPU or kernel) that can also be displayed (**/flash/crsh2**)

Follow the instructions in this section to view software crash events that have occurred on the system. These instructions assume that you are at the root prompt for the Exec mode.

---

**Step 1** View a list of software crash events by entering the following Exec mode command:

```
[local]host_name# show crash { all | list | number crash_num }
```

Notes:

- Run **show crash list** to obtain the number for a specific crash event.
- Run **show crash number crash\_num** to display the output for the target crash event.

The resulting output may not be the same for all platforms:

Information about similar crash events is suppressed in the output of this command.

**Step 2** View the dump file associated with a specific crash event.

The information contained in the dump file helps identify and diagnose any internal or external factors causing the software to crash.

- Crash # – unique number assigned by StarOS when logging the crash event

- SW Version – StarOS build release in format: RR.n(bbbbb)
- Similar Crash Count – number of similar crashes
- Time of first crash – timestamp when first crash occurred in format: YYYY-MMM-DD+hh:mm:ss
- Failure message – text of event message
- Function – code identifier
- Process – where the crash occurred (Card, CPU, PID, etc.)
- Crash time – timestamp for when the crash occurred in the format: YYYY-MMM-DD+hh:mm:ss time zone
- Recent errno – text of most recent error number.
- Stack – memory stack information
- Last Bounce – information about the messaging received prior to the crash
- Registers – memory register contents
- Current inbound message – hexadecimal information for the current inbound message
- Address Map
- Recent heap activity (oldest first)
- Recent events (oldest first)
- Profile depth

The informational content of each crash log entry varies based on the type of crash and the StarOS release.

## Reducing Excessive Event Logging

Event logging (evlogd) is a shared medium that captures event messages sent by StarOS facilities. When one or more facilities continuously and overwhelmingly keep sending a high volume of event messages, the remaining non-offender facilities are impacted. This scenario degrades system performance, especially as the number of facilities generating logs increases.

Rate-control of event message logging is handled in the Log Source path. Essentially, every second a counter is set to zero and is incremented for each log event that is sent to evlogd. If the count reaches a threshold before the second is up, the event is sent, queued or dropped (if the evlogd messenger queue is full).

When any facility exceeds the upper threshold set with this command for the rate of message logging and remains in the same state for prolonged interval, StarOS notifies the user via an SNMP trap or alarm.

A new threshold command allows a user to specify the percentage of facility event queue full. When this threshold is exceeded, an SNMP trap and alarm are generated that specifies the offending facility.

The formats for the SNMP traps associated with this command are as follows:

- **ThreshLSLogsVolume**

```
<timestamp> Internal trap notification <trap_id> (ThreshLSLogsVolume) threshold
<upper_percent>%
measured value <actual_percent>% for facility <facility_name> instance <instance_id>
```

- **ThreshClearLSLogsVolume**

```
<timestamp> Internal trap notification <trap_id> (ThreshClearLSLogsVolume) threshold
<upper_percent>%
measured value <actual_percent>% for facility <facility_name> instance <instance_id>
```

If a trigger condition occurs within the polling interval, the alert or alarm will not be generated until the end of the polling interval.

Both traps can be enabled or suppressed via the Global Configuration mode **snmp trap** command.

## Configuring Log Source Thresholds

There are three Global Configuration mode commands associated with configuring and implementing Log Source thresholds.

1. **threshold ls-logs-volume** – sets the parameters for the upper and lower thresholds for generating and clearing traps/alarms respectively.
2. **threshold poll ls-logs-volume interval** – establishes the polling interval for this threshold.
3. **threshold monitoring ls-logs-volume** – turns monitoring of this threshold on and off.

Use the following example to configure syslog servers:

```
configure
[default] threshold ls-logs-volume upper_percent [clear lower_percent]
[default] threshold poll ls-logs-volume interval duration
[no] threshold monitoring ls-logs-volume
end
```

Notes:

- *upper\_percent* and *lower\_percent* are expressed as integers from 0 to 100. Default value for *upper\_percent* is 90%. If *lower\_percent* is not specified, the default clear value is *upper\_percent*.
- **threshold poll ls-logs-volume interval** sets the polling interval in seconds. The default interval is 300 seconds (5 minutes).
- **threshold monitoring ls-logs-volume** enables or disables this feature.

You can verify the configuration of this threshold by running the Exec mode **show threshold** command.

Save the configuration as described in the *Verifying and Saving Your Configuration* chapter.

## Checkpointing Logs

Checkpointing identifies logged data as previously viewed or marked. Checkpointing allows you to only display log information since the last checkpoint.

Individual logs may have up to 50,000 events in the active log. Checkpointing the logs results in at most 50,000 events being in the inactive log files. This gives a maximum of 100,000 events in total which are available for each facility logged.

You check point log data via the Exec mode logs checkpoint command to set the log contents to a well-known point prior to special activities taking place. This command may also be a part of periodic regular maintenance to manage log data.

Checkpointing logs moves the current log data to the inactive logs. Only the most recently check pointed data is retained in the inactive logs. A subsequent check pointing of the logs results in the prior check pointed inactive log data being cleared and replaced with the newly check pointed data. Checkpointed log data is not available for viewing.



**Important** Checkpointing logs should be done periodically to prevent the log files becoming full. Logs which have 50,000 events logged will discard the oldest events first as new events are logged.



**Important** An Inspector-level administrative user cannot execute this command.

## Saving Log Files

Log files can be saved to a file in a local or remote location specified by a URL. Use the following Exec mode command to save log files:

```
save logs { url } [active] [inactive] [callid call_id]
[event-verbosity evt_verbosity] [facility facility] [level severity_level]
[pdu-data pdu_format] [pdu-verbosity pdu_verbosity] [since from_date_time
[until to_date_time]] [| { grep grep_options | more }]
```

For detailed information on the **save logs** command, see the *Exec Mode Commands* chapter in the *Command Line Interface Reference*.

## Event ID Overview



**Important** The use of event IDs depends on the platform type and the licenses running on the platform.

Identification numbers (IDs) are used to reference events as they occur when logging is enabled on the system. As described previously, logs are collected on a per facility basis. Each facility possesses its own range of event IDs as indicated in the following table.

**Table 12: System Facilities and Event ID Ranges**

Facility	Description	Event ID Range
a10	A10 Protocol Facility	28000-28999
a11	A11 Protocol Facility	29000-29999
a11mgr	A11 Manager Facility	9000-9999
aaa-client	AAA Client Facility	6000-6999
aaamgr	AAA Manager Facility	36000-36999
aaaproxy	AAA Proxy Facility	64000-64999
aal2	AAL2 Protocol Facility	173200-173299
acl-log	IP Access Control List (ACL) Facility	21000-21999

Facility	Description	Event ID Range
acsctrl	Active Charging Service Controller (ACSCTRL) Facility	90000-90999
acsmgr	Active Charging Service Manager (ACSMGR) Facility	91000-91999
afctrl	Ares Fabric Controller (ASR 5500 only)	186000-186999
afmgr	Ares Fabric Manager (ASR 5500 only)	187000-187999
alarmctrl	Alarm Controller Facility	65000-65999
alcap	Access Link Control Application Part (ALCAP) Protocol Facility	160900-161399
alcapmgr	ALCAP Manager Facility	160500-160899
asf	ASF Facility	73000-73999
asfprt	ASFPRT Facility	59000-59999
asngwmgr	Access Service Network (ASN) Gateway Manager Facility	100000-100499
asnpcmgr	ASN Paging/Location-Registry Manager Facility	100500-100999
bcmcs	Broadcast/Multicast Service (BCMCS) Facility	109000-109999
bfd	Bidirectional Forwarding Detection (BFD) Protocol Facility	170500-170999
bgp	Border Gateway Protocol (BGP) Facility	85000-85999
bindmux	BindMux Manager Facility [Intelligent Policy Control Function (IPCF)]	158200-158999
bngmgr	Broadband Network Gateway (BNG) Manager Facility	182000-182999
bssap	Base Station System Application Part+ (BSSAP+) Service Facilities	131000-131199
bssgp	Base Station System GPRS Protocol (BSSGP) Facility	115050-115099
callhome	Call Home Facility	173600-173999
cap	CAMEL Application Part (CAP) Facility	87900-88099
chatconf	CHATCONF Facility	74000-74999

Facility	Description	Event ID Range
cli	Command Line Interface (CLI) Facility	30000-30999
connproxy	Connection Proxy Facility	190000-190999
crdt-ctl	Credit Control Facility	127000-127999
csg	Closed Subscriber Groups (CSG) Facility	188000-188999
csg-acl	CSG Access Control List (ACL) Facility	189000-189999
csp	Card/Slot/Port (CSP) Facility	7000-7999
css	Content Steering Service (CSS) Facility [ESC]	77000-77499
css-sig	Content Service Selection (CSS) RADIUS Signaling Facility	77500-77599
cx-diameter	Cx Diameter Message Facility	92840-92849
dcardctrl	Daughter Card Controller Facility	62000-62999
dcardmgr	Daughter Card Manager Facility	57000-57999
demuxmgr	Demux Manager Facility	110000-110999
dgmbmgr	Diameter Gmb (DGMB) Application Manager Facility	126000-126999
dhcp	DHCP Facility	53000-53999
dhcpv6	DHCPv6 Protocol Facility	123000-123999
dhost	Distributed Host Manager Facility	83000-83999
diameter	Diameter Endpoint Facility	92000-92599
diabase	Diabase Message Facility	92800-92809
diameter-acct	Diameter Accounting Protocol Facility	112000-112999
diameter-auth	Diameter Authentication Protocol Facility	111000-111999
diameter-dns	Diameter DNS Subsystem Facility	92600-92699
diameter-ecs	ECS Diameter Signaling Facility	81990-81999
diameter-hdd	Diameter Horizontal Directional Drilling (HDD) Interface Facility	92700-92799
diameter-svc	Diameter Service Facility	121200-121999
diamproxy	Diameter Proxy Facility	119000-119999
dpath	Data Path for IPSec Facility	54000-54999

Facility	Description	Event ID Range
drvctrl	Driver Controller Facility	39000-39999
ds3mgr	DS3 and DS3/E Line Card Manager Facility (part of NPU Manager Controller Facility)	40000-40999
eap-diameter	Extensible Authentication Protocol (EAP) Diameter Facility	92870-92879
eap-ipsec	EAP IPSec Facility	118000-118999
ecs-css	ACS Session Manager (ACSMgr) Signalling Interface Facility	97000-97099
edr	Event Data Record (EDR) Facility	80000-80999
egtpc	eGTP-C Facility	141000-141999
egtpmgr	eGTP Manager Facility	143000-143999
egtpu	eGTP-U Facility	142000-142999
epdg	Evolved Packet Data Gateway (ePDG) Facility	178000-178999
evlog	Event Log Facility	2000-2999
famgr	Foreign Agent (FA) Manager Facility	33000-33999
firewall	Firewall Facility	96000-96999
fng	Femto Network Gateway (FNG) Facility	149000-149999
gbrmgr	Gb-Manager Facility	201900-202699
gcdr	GGSN-Charging Data Record (G-CDR) Facility	66000-66999
gmm	GPRS Mobility Management (GMM) Facility	88100-88299
gprs-app	General Packet Radio Service (GPRS) Application Facility	115100-115399
gprs-ns	GPRS-NS Protocol Facility	115000-115049
gq-rx-tx-diameter	Gq/Rx/Tx Diameter Messages Facility	92830-92839
gss-gcdr	GTPP Storage Server GCDR Facility	98000-98099
gtpc	GTPC Protocol Facility	47000-47999
gtpcmgr	GTPC Signaling Demultiplexer Manager Facility	46000-46999
gtp	GTP-PRIME Protocol Facility	52000-52999



Facility	Description	Event ID Range
gtpu	GTPU Protocol Facility	45000-45999
gtpumgr	GTPU Manager Facility	157200-157999
gx-ty-diameter	Gx/Ty Diameter Messages Facility	92820-92829
gy-diameter	Gy Diameter Messages Facility	92810-92819
h248prt	H.248 Protocol Facility	42000-42999
hamgr	Home Agent (HA) Manager Facility	34000-34999
hat	High Availability Task (HAT) Facility	3000-3999
hdctrl	Hard Disk (HD) Controller Facility	132000-132999
hddshare	HDD Share Facility	184000-184999
henb-gw	Home eNodeB-GW Facility	195000-195999
henbapp	Home eNodeB Application Facility	196000-196999
henbgwdemux	Home eNodeB-GW Demux Facility	194000-194999
henbgwmgr	Home eNodeB-GW Manager Facility	193000, 193999
hnb-gw	Home NodeB (HNB) Gateway Facility	151000-151999
hnbmgr	HNB Manager Facility	158000-158199
hss-peer-service	Home Subscriber Server (HSS) Facility [MME]	138000-138999
igmp	Internet Group Management Protocol (IGMP) Facility	113000-113999
ikev2	IKEv2 Facility	122000-122999
ims-authorizatn	IMS Authorization Service Library Facility	98100-98999
ims-sh	IMS SH Library Facility	124000-124999
imsimgr	International Mobile Subscriber Identity (IMSI) Manager Facility	114000-114999
imsue	IMS User Equipment (IMSUE) Facility	144000-145999
ip-arp	IP Address Resolution Protocol (ARP) Facility	19000-19999
ip-interface	IP Interface Facility	18000-18999
ip-route	IP Route Facility	20000-20999

Facility	Description	Event ID Range
ipms	Intelligent Packet Monitoring System (IPMS) Facility	134000-134999
ipne	IP Network Enabler (IPNE) Facility	192000-192999
ipsec	IPSec Protocol Facility	55000-56998
ipsg	IP Services Gateway (IPSG) Facility	128000-128999
ipsgmgr	IPSG Manager (IPSGMgr) Facility	99000-99999
ipsp	IP Pool Sharing Protocol (IPSP) Facility	68000-68999
kvstore	Key/Value Store (KVSTORE) Facility	125000-125999
l2tp-control	L2TP Control PDU Protocol Facility	50000-50999
l2tp-data	L2TP Data PDU Protocol Facility	49000-49999
l2tpdemux	L2TP Demux Facility	63000-63999
l2tpmgr	L2TP Manager Facility	48000-48999
lagmgr	Link Aggregation Group (LAG) Manager Facility	179000-179999
ldap	Lightweight Directory Access Protocol (LDAP) Request Facility	160000-160499
li	Lawful Intercept (LI) Log Facility	69000-69999
linkmgr	Link Manager Facility	89500-89999
llc	Logical Link-Control (LLC) Layer Facility (GPRS)	115700-115799
local-policy	Local Policy Configuration Facility	161400-162399
m3ap	M3 Application Protocol (M3AP) Facility	211500-211999
m3ua	MTP Level 3 (M3UA) Protocol Facility [SIGTRAN]	87500-87699
magmgr	Mobile Access Gateway (MAG) Manager Facility	137500-137999
map	Mobile Application Part (MAP) Protocol Facility [SS7]	87100-87299
megadiammgr	MegaDiameter Manager Facility	121000-121199
mme-app	Mobility Management Entity (MME) Application Facility	147000-147999

Facility	Description	Event ID Range
mme-embms	MME evolved Multimedia Broadcast Multicast Service (eMBMS) Facility	212000-212499
mme-misc	MME Miscellaneous Facility	155800-156199
mmedemux	MME Demux Manager Facility	154000-154999
mmemgr	MME Manager Facility	137000-137499
mmgr	Master Manager (MMGR) Facility	86000-86399
mobile-ip	Mobile IP (MIP) Protocol Facility	26000-26999
mobile-ip-data	MIP Tunneled Data Facility	27000-27999
mobile-ipv6	Mobile IPv6 Facility	129000-129999
mpls	Multiprotocol Label Switching (MPLS) Facility	163500-163999
mseg-app	Mobile Services Edge Gateway (MSEG) Application Facility Not supported in this release.	172300-172999
mseg-gtpc	MSEG GTPC Application Facility Not supported in this release.	172000-172199
mseg-gtpu	MSEG GTPU Application Facility Not supported in this release.	172200-172299
msegmgr	MSEG Manager Facility Not supported in this release.	171000-171999
mtp2	Message Transfer Part 2 (MTP2) Service Facility [SS7]	116900-116999
mtp3	Message Transfer Part 3 (MTP3) Service Facility [SS7]	115600-115699
multicast-proxy	Multicast Proxy Facility	94000-94999
nas	Network Access Signaling (NAS) Facility	153000-153999
netwstrg	Network Storage Facility	78000-78999
npuctrl	Network Processing Unit (NPU) Control Facility	16000-16999
npudrv	NPU Driver Facility	191000-191999
npumgr	NPU Manager (NPUMGR) Facility	17000-17999
npumgr-acl	NPUMGR ACL Facility	169000-169999
npumgr-drv	NPUMGR Driver Facility	185000-185999

Facility	Description	Event ID Range
npumgr-flow	NPUMGR Flow Facility	167000-167999
npumgr-fwd	NPUMGR Forwarding Facility	168000-168999
npumgr-init	NPUMGR Initialization Facility	164000-164999
npumgr-lc	NPUMGR LC Facility	180000-180999
npumgr-port	NPUMGR Port Facility	166000-166999
npumgr-recovery	NPUMGR Recovery Facility	165000-165999
npumgr-vpn	NPUMGR VPN Facility	181000-181999
npusim	NPUSIM Facility	176000-176999
ntfy-intf	Event Notification Interface Facility	170000-170499
orbs	Object Request Broker (ORB) System Facility	15000-15999
ospf	Open Shortest Path First (OSPF) Protocol Facility	38000-38999
ospfv3	OSPFv3 Protocol Facility [IPv6]	150000-150999
p2p	Peer-to-Peer (P2P) Facility	146000-146999
pccmgr	Policy Charging and Control (PCC) Manager Facility	159000-159499
pdg	Packet Data Gateway (PDG) Facility	152010-152999
pdgdmgr	PDG TCP Demux Manager (pdgdmgr) Facility (this is a customer-specific facility)	162400-162999
pdif	Packet Data Interworking Function (PDIF) Facility	120000-120999
pgw	Packet Data Network Gateway (PGW) Facility	139000-139999
pmm-app	Packet Mobility Management (PMM) Application Facility [SGSN]	89200-89499
ppp	Point-To-Point Protocol (PPP) Facility	25000-25999
pppoe	Point-to-Point Protocol over Ethernet (PPPoE) Facility	183000-183999
ptt	PTT Facility	76000-76999
push	PUSH (VPNMgr CDR Push) Facility	133000-133999

Facility	Description	Event ID Range
radius-acct	RADIUS Accounting Protocol Facility	24000-24999
radius-auth	RADIUS Authentication Protocol Facility	23000-23999
radius-coa	RADIUS Change of Authorization (CoA) and Disconnect Facility	70000-70999
ranap	Radio Access Network Application Part (RANAP) Facility	87700-87899
rct	Recovery Control Task (RCT) Facility	13000-13999
rdt	Redirector Task (RDT) Facility	67000-67999
resmgr	Resource Manager (RM) Facility	14000-14999
rf-diameter	Rf Diameter Messages Facility	92860-92869
rip	Routing Information Protocol (RIP) Facility	35000-35999
rohc	Robust Header Compression (ROHC) Protocol Facility	103000-103999
rsvp	RSVP Protocol Facility	93000-93999
rua	RANAP User Adaptation (RUA) Protocol Facility	152000-152009
slap	S1 Application Protocol (SIAP) Facility	155200-155799
saegw	System Architecture Evolution Gateway Facility	191000-191999
sccp	Signalling Connection Control Part (SCCP) Protocol Facility [SS7]	86700-86899
sct	Shared Configuration Task (SCT) Facility	32000-32099
sctp	Stream Control Transmission Protocol (SCTP) Protocol Facility	87300-87499
sess-gr	SESS-GR Facility	77600-77999
sessctrl	Session Controller Facility	8000-8999
sessmgr	Session Manager Facility	10000-12999
sesstrc	Session Trace Facility	155000-155199
sft	Switch Fabric Task (SFT) Facility	58000-58999
sgs	SGs Interface Protocol Facility [MME]	173000-173199

Facility	Description	Event ID Range
sgsn-app	SGSN Application Interface Facility	115900-115999
sgsn-failures	SGSN Call Failures Facility	89100-89199
sgsn-gtpc	SGSN GTP-C Protocol Facility	116000-116599
sgsn-gtpu	SGSN GTP-U Protocol Facility	86900-87099
sgsn-mbms-bearer	SGSN MBMS Bearer Application (SMGR) Facility	116600-116799
sgsn-misc	SGSN Miscellaneous Facility	88800-89099
sgsn-system	SGSN System Components Facility	86400-86499
sgsn-test	SGSN Tests Facility	88700-88799
sgsn2	SGSN2 Facility	114000-117999
sgtpcmgr	SGSN GTP-C (SGTPC) Manager Facility	117000-117999
sgw	Serving Gateway (SGW) Facility	140000-140999
sh-diameter	Sh Diameter Messages Facility	92850-92859
sipcdprt	SIPCDPRT Facility	95000-95999
sitmain	System Initiation Task (SIT) Main Facility	4000-4999
sm-app	Short Message Service (SMS) Facility	88300-88499
sms	SMS Service Facility	116800-116899
sndcp	Sub Network Dependent Convergence Protocol (SNDCP) Facility	115800-115899
snmp	Simple Network Management Protocol (SNMP) Facility	22000-22999
sprmgr	Subscriber Policy Register (SPR) Manager Facility	159500-159999
srdb	Static Rating Database Facility	102000-102999
srp	Service Redundancy Protocol (SRP) Facility	84000-84999
sscfnni	SSCFNNI Protocol Facility [ATM]	115500-115599
sscop	SSCOP Protocol Facility [ATM]	115400-115499
ssh-ipsec	SSH IP Security Facility	56999-56999
ssl	SSL Facility (this is a customer-specific facility)	156200-157199

Facility	Description	Event ID Range
stat	Statistics Facility	31000-31999
system	System Facility	1000-1999
tacacs+	TACACS+ Protocol Facility	37000-37999
taclep	TACLCP Facility	44000-44999
tcap	Transaction Capabilities Application Part (TCAP) Protocol Logging Facility [SS7]	86500-86699
testctrl	Test Controller Facility	174000-174999
testmgr	Test Manager Facility	175000-175999
threshold	Threshold Facility	61000-61999
ttg	Tunnel Termination Gateway (TTG) Facility	130000-130999
tucl	TCP/UDP Convergence Layer (TUCL) Facility [SS7]	88500-88699
udr	User Data Record (UDR) Facility	79000-79999
user-data	User-Data Facility	51000-51999
user-l3tunnel	User L3 Tunnel Facility	75000-75999
usertcp-stack	User TCP Stack Facility	173300-173499
vim	Voice Instant Message (VIM) Facility	60000, 60999
vinfo	VINFO Facility	82000, 82999
vmgctrl	Virtual Media Gateway (VMG) Controller Facility	41000, 41999
vmgctxmgr	VMG Context Manager Facility	43000, 43999
vpn	Virtual Private Network (VPN) Facility	5000-5999
wimax-data	WiMAX DATA Facility	104900-104999
wimax-r6	WiMAX R6 Protocol (Signaling) Facility	104000-104899

## Event Severities

The system provides the flexibility to configure the level of information that is displayed when logging is enabled. The following levels are supported:

- **critical:** Logs only those events indicating a serious error has occurred that is causing the system for a system component to cease functioning. This is the highest severity level.

- **error:** Logs events that indicate an error has occurred that is causing the system or a system component to operate in a degraded state. This level also logs events with a higher severity level.
- **warning:** Logs events that may indicate a potential problem. This level also logs events with a higher severity level.
- **unusual:** Logs events that are very unusual and may need to be investigated. This level also logs events with a higher severity level.
- **info:** Logs informational events and events with a higher severity level.
- **trace:** Logs events useful for tracing and events with a higher severity level.
- **debug:** Logs all events regardless of the severity.

Each of the above levels correspond to the "severity" level of the event ID. Therefore, only those event IDs with a "severity" level equal to the logging level are displayed.

## Understanding Event ID Information in Logged Output

This section explains the event information that is displayed when logging is enabled.

The following displays a sample output for an event that was logged.

```
2011-Dec-11+5:18:41.993 [cli 30005 info] [8/0/609 cli:8000609 _commands_cli.c:1290] [software
internal system] CLI session ended for Security Administrator admin on device /dev/pts/2
```

The following table describes the elements of contained in the sample output.

**Table 13: Event Element Descriptions**

Element	Description
2011-Dec-11+5:18:41.993	Date/Timestamp indicating when the event was generated
[cli 30005 info]	Information about the event including: <ul style="list-style-type: none"> <li>• The facility the event belongs to</li> <li>• The event ID</li> <li>• The event's severity level</li> </ul> In this example, the event belongs to the CLI facility, has an ID of 3005, and a severity level of "info".
[8/0/609 cli:8000609 _commands_cli.c:1290]	Information about the specific CLI instance.
[software internal system]	Indicates that the event was generated because of system operation.
CLI session ended for Security Administrator admin on device /dev/pts/2	The event's details. Event details may, or may not include variables that are specific to the occurrence of the event.





# CHAPTER 16

## Troubleshooting

---

This chapter provides information and instructions for using the system command line interface (CLI) for troubleshooting any issues that may arise during system operation.

Refer to the *ASR 5500 Installation Guide* for comprehensive descriptions of the hardware components addressed by these troubleshooting procedures.

- [Detecting Faulty Hardware, on page 229](#)
- [Taking Corrective Action, on page 248](#)
- [Verifying Network Connectivity, on page 251](#)
- [Using the System Diagnostic Utilities, on page 254](#)
- [Generating an SSD, on page 257](#)
- [Configuring and Using the Support Data Collector, on page 257](#)

## Detecting Faulty Hardware

When power is applied to the chassis, power is sequentially applied to the Management I/O (MIO/UMIO/MIO2) cards, Data Processing Cards (DPC/UDPC/DPC2/UDPC2s), Fabric and Storage Cards (FSCs), and System Status Cards (SSCs).

Each PFU and card installed in the system incorporates light emitting diodes (LEDs) that indicate its operating status. This section describes how to use these status LEDs to verify that all of the installed components are functioning properly.



---

### Important

As the system progresses through its boot process, some cards will not exhibit immediate LED activity. Allow several minutes to elapse after a reboot is initiated before checking the LEDs on the various cards to verify that the boot process has successfully completed.

---

## Licensing Issues

The system boot process is governed by StarOS licenses. During the startup process, each card performs a series of Power-On Self Tests (POSTs) to ensure that the hardware is operational. These tests also verify that the card meets all license requirements to operate in this chassis.

Refer to *Chassis Universal License Requirements* in the *ASR 5500 Installation Guide* for additional information on the effect licenses and card types have on the boot process.

## Using the CLI to View Status LEDs

Status LEDs for all cards can be viewed via the CLI by entering the Exec mode **show leds all** command.

```
[local]host_name# show leds all
```

The following displays a sample of this command's output.

```
Slot 01: Run/Fail: Green | Active: Off | Redundant: Green
Slot 02: Run/Fail: Green | Active: Off | Redundant: Green
Slot 03: Run/Fail: Green | Active: Off | Redundant: Green
Slot 05: Run/Fail: Green | Active: Green | Redundant: Green Master: Green
Slot 06: Run/Fail: Green | Active: Off | Redundant: Green Master:Off
Slot 08: Run/Fail: Green | Active: Off | Redundant: Green
Slot 11: Run/Fail: Green | Active: Green | Redundant: Green Status: Green |
Service: Off
Slot 12: Run/Fail: Green | Active: Green | Redundant: Green Status: Green |
Service: Off
Slot 13: Run/Fail: Green | Active: Green | Redundant: Green
Slot 14: Run/Fail: Green | Active: Green | Redundant: Green
Slot 15: Run/Fail: Green | Active: Green | Redundant: Green
Slot 16: Run/Fail: Green | Active: Green | Redundant: Green
Slot 17: Run/Fail: Green | Active: Green | Redundant: Green
```

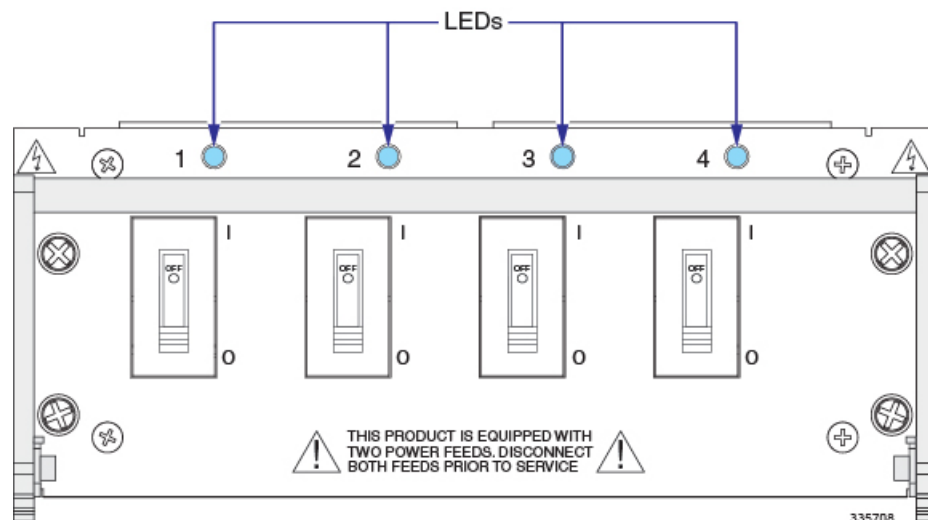
The status of the two Power Filter Units (PFUs) can be viewed by entering the Exec mode **show power chassis** command.

## Checking the LEDs on the PFU

Each PFU has four LEDs along the top edge of its front panel. You must unsnap the top front cover from the chassis to view these LEDs. Each LED is associated with one of the four -48 VDC power feeds connected to the PFU.

Each LED on the PFU should illuminate blue for normal operating conditions.

Figure 13: PFU LEDs



The possible states for these LEDs are described in the following table. If the LED is not blue, use the troubleshooting information below to diagnose the problem.

Table 14: PFU LED States

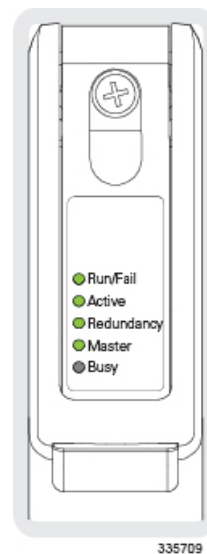
Color	Description	Troubleshooting
Blue	Power feed is supplying -48VDC to this power plane	None needed.
None	PFU is not receiving power to one or more of its power planes.	<p>Verify that each circuit breaker is in the ON position.</p> <p>Verify that the RTN and -48VDC lugs are attached properly to the posts on the upper rear of the chassis.</p> <p>Verify that the ground lug is attached properly.</p> <p>Use a voltmeter to verify that the power distribution panel is supplying the correct voltage and sufficient current to the terminals at the rear of the PFU.</p> <p>Check the cables from the power source to the rack for continuity.</p> <p>If a power distribution panel (PDP) is installed between the power distribution frame (PDF) and the chassis, verify that its circuit breakers are set to ON.</p> <p>If a PDP is installed between the PDF and the chassis, check the cables from the PDP to the chassis for continuity.</p> <p>If all of the above suggestions have been verified, then it is likely that the PFU is not functional. Please contact your service representative.</p>

## Checking the LEDs on the MIO Card

Each MIO/UMIO/MIO2 is equipped with the following LEDs:

- Run/Fail
- Active
- Redundancy
- Master
- Busy

Figure 14: MIO Card Status LEDs



The possible states for all MIO/UMIO/MIO2 LEDs are described in the sections that follow.

### MIO Run/Fail LED States

The MIO/UMIO/MIO2 *Run/Fail* LED indicates the overall status of the card. This LED should be steady green for normal operation.

The possible states for this LED are described in the following table. If the LED is not green, use the troubleshooting information in the table to diagnose the problem.

Table 15: MIO Run/Fail LED States

Color	Description	Troubleshooting
Green	Card powered with no errors detected	None needed.
Blinking Green	Card is initializing and/or loading software	This is normal operation during boot-up.
Red	Card powered with error(s) detected	Errors were detected during the Power On Self Tests (POSTs). It is likely that the errors were logged to the system's command line interface during boot.

Color	Description	Troubleshooting
None	Card is not receiving power	<p>Verify that the LEDs on the PFUs are blue. If they are not, refer to <a href="#">Checking the LEDs on the PFU, on page 230</a> for troubleshooting information.</p> <p>Verify that the power source is supplying ample voltage and current to the chassis.</p> <p>Verify that the card is properly installed per the instructions in the <i>ASR 5500 Installation Guide</i>.</p> <p>If all of the above suggestions have been verified, it is possible that the MIO is not functional. Please contact your service representative.</p>

## MIO Active LED States

The *Active* LED on the MIO/UMIO/MIO2 indicates that the software is loaded on the card and it is ready for operation. For the MIO installed in chassis slot 5, this LED should be green for normal operation. For the MIO installed in slot 6, this LED should be off for normal operation.

The possible states for this LED are described in the following table. If the LED is not green, use the troubleshooting information in the table to diagnose the problem.

**Table 16: Active LED States**

Color	Description	Troubleshooting
Green	Card is active	None needed for the MIO/UMIO/MIO2 in slot 5. If green for the MIO/UMIO/MIO2 in slot 6, verify that the MIO/UMIO/MIO2 in slot 5 is installed and licensed properly according to the instructions in the <i>ASR 5500 Installation Guide</i> .
Blinking Green	Tasks or processes being migrated from the active MIO to the standby MIO.	Refer to <i>Monitoring the System</i> for information on determining the status of the MIO/UMIO/MIO2 and system software processes.
None	Card is not receiving power. <b>OR</b> Card has failed.	Verify that the <i>Run/Fail</i> LED is green. If so, the card is receiving power and POST results are positive. If it is off, refer to <a href="#">MIO Run/Fail LED States, on page 232</a> for troubleshooting information.

## MIO Redundancy LED States

The *Redundancy* LED on the MIO/UMIO/MIO2 indicates that software is loaded on the card, but it is serving as a redundant component. For the MIO/UMIO/MIO2 installed in slot 6, this LED should be green for normal operation. For the MIO/UMIO installed in slot 8, this LED should be off for normal operation.

The possible states for this LED are described in the following table. If the LED is not green, use the troubleshooting information in the table to diagnose the problem.

Table 17: MIO Redundancy LED States

Color	Description	Troubleshooting
Green	Card is in redundant mode	None needed. If green for the MIO/UMIO/MIO2s in slot 5 and slot 6, the cards and ports are fully backed up.
Amber	Card or port on this card is not backed up by other MIO.	Check the status of the other MIO/UMIO/MIO2. If it has failed or one or more of its ports are no longer active, the system can continue to function but redundancy is compromised.
		Refer to <i>Monitoring the System</i> for information on determining the status of the MIO/UMIO/MIO2 and system software processes.
Blinking Amber	Tasks or processes being migrated from the active MIO to the standby MIO.	Refer to <i>Monitoring the System</i> for information on determining the status of the MIO/UMIO/MIO2 and system software processes.
None	Card is not receiving power. <b>OR</b> Card has failed.	Verify that the <i>Run/Fail</i> LED is green. If so, the card is receiving power and POST results are positive. If it is off, refer to <a href="#">MIO Run/Fail LED States, on page 232</a> for troubleshooting information on.

## MIO Master LED States

The *Master* LED on the MIO/UMIO/MIO2 indicates whether the card is in Active or Standby mode.

The possible states for this LED are described in the following table. If the LED is not green, use the troubleshooting information also provided to diagnose the problem.

Table 18: MIO Master LED States

Color	Description	Troubleshooting
Green	This card is the Active MIO.	None needed.

Color	Description	Troubleshooting
Blinking Green	Tasks or processes being migrated from the active MIO to the standby MIO.	Refer to <i>Monitoring the System</i> for information on determining the status of the MIO/UMIO/MIO2 and system software processes.
None	This card is the Standby MIO. <b>OR</b> Card has failed.	Verify that the <i>Run/Fail</i> LED is green. If so, the card is receiving power and POST results are positive. If it is off, refer to <a href="#">MIO Run/Fail LED States, on page 232</a> for troubleshooting information.
		Refer to <i>Monitoring the System</i> for information on determining the status of the MIO/UMIO/MIO2 and system software processes.

## MIO Busy LED States

The *Busy* LED on the MIO/UMIO/MIO2 indicates that the card is accessing the RAID solid state drives on the FSCs.

This LED is off when no file storage activity is occurring.

The possible states for this LED are described in the following table. If the LED is not green, use the troubleshooting information in the table to diagnose the problem.

Table 19: MIO Busy LED States

Color	Description	Troubleshooting
Green	Files are being transferred to or accessed from the RAID configuration on the FSCs.	None required.
None	No RAID activity.	<a href="#">Checking the LEDs on the FSC, on page 240</a>
	<b>OR</b> RAID configuration is unavailable.	

## MIO – Interface Link LED States

The *Link* LED associated with a 1000Base-T (management) or 10 Gigabit Ethernet port on an MIO/UMIO daughter card (subscriber traffic) indicates the status of the network link. This LED should be green for normal operation.

The possible states for this LED are described in the following table. If the LED is not green, use the troubleshooting information in the table to diagnose the problem.

Table 20: MIO – Interface Link LED States

Color	Description	Troubleshooting
Green	Link is up	None needed.  <b>NOTE:</b> This LED will not indicate the presence of a network link until the interface parameters are set during the software configuration process.
None	No power to card.  <b>OR</b>  Link is down.	Verify that the <i>Run/Fail</i> LED is green. If so, the card is receiving power. If it is off, refer to <a href="#">MIO Run/Fail LED States, on page 232</a> for troubleshooting information.
		Verify that the interface is cabled properly.
		Verify that the device on which the interface is located is cabled and powered properly.

## MIO – Interface Activity LED States

The *Activity* LED associated with a 1000Base-T (management) or 10 Gigabit Ethernet port on an MIO/UMIO/MIO2 daughter card (subscriber traffic) indicates the presence of traffic on the network link. This LED should be green when data is being transmitted or received over the interface.

The possible states for this LED are described in the following table. If the LED is not green, use the troubleshooting information in the table to diagnose the problem.

Table 21: MIO – Interface Activity LED States

Color	Description	Troubleshooting
Flashing Green	Traffic is present on the link	None needed.
None	No traffic is present on the link	None needed if there is no activity on the link. Prior to interface configuration, this is normal operation.

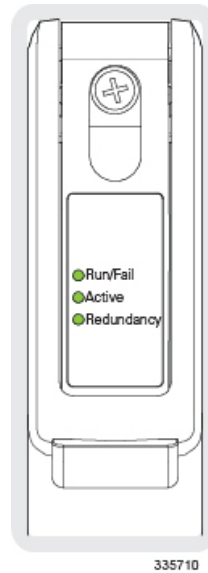
## Checking the LEDs on the DPC

Each DPC/UDPC or /DPC2/UDPC2 is equipped with status LEDs as listed below:

- Run/Fail
- Active
- Redundancy



Figure 15: DPC Status LEDs



The possible states for all of the DPC/UDPC or /DPC2/UDPC2 LEDs are described in the sections that follow.

### DPC Run/Fail LED States

The DPC/UDPC or /DPC2/UDPC2 *Run/Fail* LED indicates the overall status of the card. This LED should be green for normal operation.

The possible states for this LED are described in the following table. If the LED is not green, use the troubleshooting information in the table to diagnose the problem.

Table 22: DPC Run/Fail LED States

Color	Description	Troubleshooting
Green	Card powered up with no errors detected.	None needed.
Blinking Green	Card is initializing and/or loading software.	This is normal operation during boot-up.
Red	Card powered up with error(s) detected.	Errors were detected during the Power On Self Tests (POSTs). It is likely that the errors were logged to the system's command line interface during boot.

Color	Description	Troubleshooting
None	Card is not receiving power.	Verify that the LEDs on the PFUs are blue. If they are not, refer to <a href="#">Checking the LEDs on the PFU, on page 230</a> for troubleshooting information.
		Verify that the power source is supplying ample voltage and current to the chassis.
		Verify that the card is properly installed and licensed per the instructions in the <i>ASR 5500 Installation Guide</i> .
		If all of the above suggestions have been verified, it is possible that the DPC/UDPC or /DPC2/UDPC2 is not functional. Please contact your service representative.

## DPC Active LED States

The *Active* LED on the DDPC/UDPCPC or /DPC2/UDPC2 indicates that the software is loaded on the card and that the card is ready for operation. When the system first boots up, all installed DPC/UDPCs or /DPC2/UDPC2s are booted into standby mode. The system must then be configured as to which DPC/UDPCs or /DPC2/UDPC2s should serve as redundant components (remain in standby mode) and which should function as active components.

The possible states for this LED are described in the following table. If the LED is not green, use the troubleshooting information in the table to diagnose the problem.

Table 23: DPC Active LED States

Color	Description	Troubleshooting
Green	Card is active.	The first time power is applied to the system, all of the DPC/UDPCs or /DPC2/UDPC2s should be booted into the standby mode. Therefore, this LED should be off.
Blinking Green	Tasks or processes are being migrated from an active DPC to a standby DPC.	Verify that the <i>Redundancy</i> LED on a standby DPC/UDPC or /DPC2/UDPC2 is also blinking green. If so, there is an issue with the active DPC/UDPC or /DPC2/UDPC2 and it is transferring its processes.
		Refer to <i>Monitoring the System</i> for information on determining the status of the DPC/UDPC or /DPC2/UDPC2 and system software processes and functionality.

Color	Description	Troubleshooting
None	Card is not receiving power. <b>OR</b> Card is in Standby Mode.	Verify that the <i>Run/Fail</i> LED is green. If so, the card is receiving power and POST results are positive. If it is off, refer to <a href="#">DPC Run/Fail LED States, on page 237</a> for troubleshooting information.  Check the state of the <i>Redundancy</i> LED. If it is green, the card is in standby mode. This is normal operation for the initial power-up. If needed, refer to the <i>Configuring DPC Availability</i> section of <i>System Settings</i> for information on making the card active.

## DPC Redundancy LED States

The *Redundancy* LED on the DPC/UDPC or /DPC2/UDPC2 indicates that software is loaded on the card, but it is serving as a standby component. DPC/UDPCs or /DPC2/UDPC2s support n:1 redundancy; the Redundancy LED should be green on only one DPC/UDPC or /DPC2/UDPC2 for normal system operation.

The possible states for this LED are described in the following table. If the LED is not green, use the troubleshooting information in the table to diagnose the problem.

**Table 24: DPC Redundancy LED States**

Color	Description	Troubleshooting
Green	Card is in standby mode.	None needed. There is at least one DPC/UDPC or /DPC2/UDPC2 in Standby mode.
Amber	Card is not backed up by a standby DPC.	Check the status of the other DPC/UDPCs or /DPC2/UDPC2s. If one DPC/UDPC or /DPC2/UDPC2 has failed or has been removed from the chassis, the system can continue to function but redundancy is compromised.  Refer to <i>Monitoring the System</i> for information on determining the status of the DPC/UDPC or /DPC2/UDPC2 and system software processes.
Blinking Amber	Tasks or processes being migrated from an active DPC to the standby DPC.	Refer to <i>Monitoring the System</i> for information on determining the status of the DPC/UDPC or /DPC2/UDPC2 and system software processes.
None	Card is not receiving power. <b>OR</b> Card has failed.	Verify that the <i>Run/Fail</i> LED is green. If so, the card is receiving power and POST results are positive. If it is off, refer to <a href="#">DPC Run/Fail LED States, on page 237</a> for troubleshooting information.

## Checking the LEDs on the FSC

Each FSC is equipped with the following LEDs as shown in the accompanying figure:

- Run/Fail
- Active
- Redundancy
- Drive 1 Activity
- Drive 2 Activity

**Figure 16: FSC Status LEDs**



The possible states for all FSC LEDs are described in the sections that follow.

### FSC Run/Fail LED States

The FSC *Run/Fail* LED indicates the overall status of the card. This LED should be green for normal operation.

The possible states for this LED are described in the following table. If the LED is not green, use the troubleshooting information in the table to diagnose the problem.

**Table 25: FSC Run/Fail LED States**

Color	Description	Troubleshooting
Green	Card powered with no errors detected	None needed.

Color	Description	Troubleshooting
Blinking Green	Card is initializing and/or loading software	This is normal operation during boot-up.
Red	Card powered with error(s) detected	Errors were detected during the Power On Self Tests (POSTs). It is likely that the errors were logged to the system's command line interface during boot.
None	Card is not receiving power	Verify that the LEDs on the PFUs are blue. If they are not, refer to <a href="#">Checking the LEDs on the PFU, on page 230</a> for troubleshooting information.
		Verify that the power source is supplying ample voltage and current to the chassis.
		Verify that the card is properly installed per the instructions in the <i>ASR 5500 Installation Guide</i> .
		If all of the above suggestions have been verified, it is possible that the FSC is not functional. Please contact your service representative.

## FSC Active LED States

The *Active* LED on the FSC indicates that the software is loaded on the card and that the card is ready for operation. When the system first boots up, all installed FSCs are booted into ready mode.

The possible states for this LED are described in the following table. If the LED is not green, use the troubleshooting information in the table to diagnose the problem.

Table 26: FSC Active LED States

Color	Description	Troubleshooting
Green	Card is active.	The first time power is applied to the system, all of the FSCs should be booted into the ready mode. Therefore, this LED should be on.
Blinking Green	Tasks or processes being migrated from an active FSC to a standby FSC.	Verify that the <i>Redundancy</i> LED on a standby FSC is also blinking green. If so, there is an issue with the active FSC and it is transferring its processes.
		Refer to <i>Monitoring the System</i> for information on determining the status of the FSC and system software processes and functionality.

Color	Description	Troubleshooting
None	Card is not receiving power. <b>OR</b> Card is in Standby Mode.	Verify that the <i>Run/Fail</i> LED is green. If so, the card is receiving power and POST results are positive. If it is off, refer to <a href="#">FSC Run/Fail LED States, on page 240</a> for troubleshooting information.
		Check the state of the <i>Redundancy</i> LED. If it is green, the card is in standby mode.

## FSC Redundancy LED States

The *Redundancy* LED on the FSC indicates that software is loaded on the card, but it is serving as a redundant component. FSC support n+1 redundancy; the Redundancy LED should be green on only one FSC for normal system operation.

The possible states for this LED are described in the following table. If the LED is not green, use the troubleshooting information in the table to diagnose the problem.

Table 27: FSC Redundancy LED States

Color	Description	Troubleshooting
Green	Card is in redundant mode	None needed. There is at least one FSC in Standby mode.
Amber	Card is not backed up by a standby FSC.	Check the status of the other FSCs. If one FSC has failed or has been removed from the chassis, the system can continue to function but redundancy is compromised.
		Refer to <i>Monitoring the System</i> for information on determining the status of the FSC and system software processes.
Blinking Amber	Tasks or processes being migrated from an active FSC to the standby FSC.	Refer to <i>Monitoring the System</i> for information on determining the status of the FSC and system software processes.
None	Card is not receiving power. <b>OR</b> Card has failed.	Verify that the <i>Run/Fail</i> LED is green. If so, the card is receiving power and POST results are positive. If it is off, refer to <a href="#">FSC Run/Fail LED States, on page 240</a> for troubleshooting information.

## FSC Drive n Activity LED States

The *Drive 1 Activity* and *Drive 2 Activity* LEDs on the FSC indicate that the RAID solid state drives (SSDs) are being accessed by the MIO. Drive 1 and Drive 2 on each FSC form a RAID 0 configuration.



**Important** The FSC-400GB is equipped with a single 400 GB drive. Only the *Drive 1 Activity* LED will be active; the *Drive 2 Activity* LED will always be off (None).

The possible states for this LED are described in the following table. If the LED is not green, use the troubleshooting information also provided to diagnose the problem.

**Table 28: FSC Driven Activity LED States**

Color	Description	Troubleshooting
Green	Files are being transferred to or accessed from the RAID configuration by the MIO.	None required.
None	There is no RAID activity. <b>OR</b> RAID configuration is unavailable.	<a href="#">Checking the LEDs on the MIO Card, on page 231</a> FSC-400GB is not equipped with a second SDD. Only the <i>Drive 1 Activity</i> LED will be active.
None	Card is not receiving power	Verify that the <i>Run/Fail</i> LED is green. If so, the card is receiving power and POST results are positive. If it is off, refer to <a href="#">FSC Run/Fail LED States, on page 240</a> for troubleshooting information.

## Checking the LEDs on the SSC

Each SSC is equipped with the following LEDs as shown in the accompanying figure:

- Run/Fail
- Active
- Redundancy
- System Status
- System Service

Figure 17: SSC Status LEDs



The possible states for all SSC LEDs are described in the sections that follow.

## SSC Run/Fail LED States

The SSC *Run/Fail* LED indicates the overall status of the card. This LED should be green for normal operation.

The possible states for this LED are described in the following table. If the LED is not green, use the troubleshooting information in the table to diagnose the problem.

Table 29: SSC Run/Fail LED States

Color	Description	Troubleshooting
Green	Card powered with no errors detected	None needed.
Blinking Green	Card is initializing and/or loading software	This is normal operation during boot-up.
Red	Card powered with error(s) detected	Errors were detected during the Power On Self Tests (POSTs). It is likely that the errors were logged to the system's command line interface during boot.



Color	Description	Troubleshooting
None	Card is not receiving power	Verify that the LEDs on the PFUs are blue. If they are not, refer to <a href="#">Checking the LEDs on the PFU, on page 230</a> for troubleshooting information.
		Verify that the power source is supplying ample voltage and current to the chassis.
		Verify that the card is properly installed per the instructions in the <i>ASR 5500 Installation Guide</i> .
		If all of the above suggestions have been verified, it is possible that the SSC is not functional. Please contact your service representative.

## SSC Active LED States

The *Active* LED on the SSC indicates that the software is loaded on the card and that the card is ready for operation. When the system first boots up, both SSCs are booted into ready mode.

The possible states for this LED are described in the following table. If the LED is not green, use the troubleshooting information in the table to diagnose the problem.

Table 30: SSC Active LED States

Color	Description	Troubleshooting
Green	Card is active.	The first time power is applied to the system, both SSCs should be booted into the ready mode. Therefore, this LED should be on.
Blinking Green	Tasks or processes being migrated from an active FSC to a standby FSC.	Verify that the <i>Redundancy</i> LED on a Standby SSC is also blinking green. If so, there is an issue with the active SSC and it is transferring its processes.
		Refer to <i>Monitoring the System</i> for information on determining the status of the SSC and system software processes and functionality.
None	Card is not receiving power. <b>OR</b> Card is in Standby Mode.	Verify that the <i>Run/Fail</i> LED is green. If so, the card is receiving power and POST results are positive. If it is off, refer to the <i>SSC Run/Fail LED States</i> section for troubleshooting information.
		Check the state of the <i>Redundancy</i> LED. If it is green, the card is in standby mode.

## SSC Redundancy LED States

The *Redundancy* LED on the SSC indicates that software is loaded on the card, but it is serving as a standby component. SSC support 1:1 redundancy; the *Redundancy* LED should be green on the other SSC for normal system operation.

The possible states for this LED are described in the following table. If the LED is not green, use the troubleshooting information in the table to diagnose the problem.

Table 31: SSC Redundancy LED States

Color	Description	Troubleshooting
Green	Card is in standby mode	None needed. The other SSC should be in Standby mode.
Amber	Card is not backed up by the standby SSC.	Check the status of the other SSC. If one it has failed or has been removed from the chassis, the system can continue to function but redundancy is compromised.
		Refer to <i>Monitoring the System</i> for information on determining the status of the SSC and system software processes.
Blinking Amber	Tasks or processes being migrated from the active SSC to the standby SSC.	Refer to <i>Monitoring the System</i> for information on determining the status of the SSC and system software processes.
None	Card is not receiving power. <b>OR</b> Card has failed.	Verify that the <i>Run/Fail</i> LED is green. If so, the card is receiving power and POST results are positive. If it is off, refer to the <i>SSC Run/Fail LED States</i> section for troubleshooting information.

## SSC System Status LED States

The *System Status* LED on the SSC indicates the that there is a loss of service somewhere in the system. If this LED is red, the system requires maintenance or service (for example, the system could not locate a a valid software image at boot-up, or a high temperature condition exists).

The possible states for this LED are described in the following table. If the LED is not green, use the troubleshooting information also provided to diagnose the problem.

Table 32: SSC System Status LED States 11

Color	Description	Troubleshooting
Green	System is operating normally	None required.
Red	The system has experienced a loss of service.	Refer to <i>Monitoring the System</i> for information on determining the status of system hardware and software processes.

Color	Description	Troubleshooting
None	Card is not receiving power	Verify that the <i>Run/Fail</i> LED is green. If so, the card is receiving power and POST results are positive. If it is off, refer to the <i>SSC Run/Fail LED States</i> section for troubleshooting information.

## SSC System Service LED States

The *System Service* LED on the SSC illuminates amber to indicate that the system has experienced a hardware component failure.

This LED is off during normal operation.

The possible states for this LED are described in the following table. If the LED is not green, use the troubleshooting information in the table to diagnose the problem.

Table 33: SSC System Service LED States 12

Color	Description	Troubleshooting
Amber	System requires maintenance (fan filter, temperature warning, PFU outage etc.).	<i>Monitoring the System</i> for <b>show</b> commands, the outputs of which will assist in further determining the problem.
		Refer to <i>System Logs</i> for information on how to view logs.
None	No component failures have been detected. <b>OR</b> Card is not receiving power.	No maintenance needed.

## Testing System Alarm Outputs

The system provides the following two physical alarm mechanisms:

- **System Audible Alarm:** Located on the SSC, the speaker is used to provide an audible indicator that a minor, major, or critical alarm has occurred.
- **CO Alarms Interface:** Located on the SSC, this interface provides a DB-15 connector that enables three dry-contact relays (Form C) for the triggering of external audio and/or visual indicators. These indicators can be used to alert that either a minor, major, or critical alarm has occurred.

The operation of these alarms can be tested by issuing the following command:

```
[local]host_name# test alarm { audible | central-office [critical | major | minor] }
```

When this command is executed, the specified alarm is activated for a period of 10 seconds. After this time, the alarm will return to its previous condition.

## Taking Corrective Action

In the event that an issue was discovered with an installed application or line card, depending on the severity, it may be necessary to take corrective action.

The system provides several redundancy and fail-over mechanisms to address issues with application and line cards in order to minimize system downtime and data loss. These mechanisms are described in the sections that follow.

## Switching MIOs

When the system boots up, the MIO/UMIO/MIO2 installed in chassis slot 5 will boot into the Active mode and begin booting other system components. The MIO/UMIO/MIO2 installed in chassis slot 6 will automatically be booted into Standby mode dictating that it will serve as a redundant component. The active MIO/UMIO/MIO2 automatically synchronizes currently running tasks or processes with the standby MIO/UMIO/MIO2.

In the event of a critical failure on the MIO/UMIO/MIO2 in slot 5, system control will be automatically switched to the standby MIO/UMIO/MIO2 in slot 6. This is a relatively seamless transition because the two are synchronized. The formerly active MIO will then enter the standby mode allowing it to be safely replaced or restored.

In the event that an issue arises that is not severe enough for the system to perform an automatic switchover, a manual switchover can be invoked by executing the following commands from the Exec mode prompt.

---

**Step 1** Initiate a manual MIO/UMIO/MIO2 switch over by entering the following command:

```
[local]host_name# card switch from <5 or 6> to <6 or 5>
```

You will receive the following prompt:

```
Are You Sure? [Yes|No]:
```

**Step 2** Press **Y** to start the switchover.

**Step 3** Verify that the switchover was successful by entering the **show card table** command at the Exec mode prompt:

Check the entry in the *Oper State* column next to the MIO/UMIO/MIO2 just switched. Its state should be *Standby*.

---

## Busying Out a DPC

This **busy-out** command moves processes from the source DPC/UDPC or DPC2/UDPC2 to the destination DPC/UDPC or DPC2/UDPC2, or disables the DPC/UDPC or DPC2/UDPC2 from accepting any new calls. When busy-out is enabled, the DPC/UDPC or DPC2/UDPC2 stops receiving new calls but continues to process calls until they are completed. The command prompt is returned once the command is initiated. The busy-out procedure is completed in background.

---

**Step 1** Initiate a busy-out by entering the following command:

```
[local]host_name# card busy-out slot_number
```

You will receive the following prompt:

```
Are You Sure? [Yes|No]:
```

**Step 2** Press **Y** to start the switchover.

**Step 3** Verify that the busy-out was successful by entering the **show card table** command at the Exec mode prompt:

Check the entry in the *Oper State* column next to the DPC/UDPC or DPC2/UDPC2 just busied-out. Its state should be *Standby*.

---

## Migrating a DPC

When the system boots up, all DPC/UDPCs or DPC2/UDPC2s enter the "standby" mode. The standby mode indicates that the card is available for use but is not configured for operation. Installed components can be made active through the software configuration process. Cards that are not configured to enter the "active" mode will remain in standby mode for use as redundant components.

In the event of the critical failure of a DPC/UDPC or DPC2/UDPC2, tasks will be automatically be migrated from the active card to a redundant card in standby mode.

In the event that an issue arises that is not severe enough for the system to perform an automatic migration, a manual migration can be initiated. Follow the instructions below to manually initiate a DPC/UDPC or DPC2/UDPC2 migration. These instructions assume you are at the root prompt for the Exec mode.

---

**Step 1** Initiate a DPC/UDPC or DPC2/UDPC2 migration by entering the following command:

```
[local]host_name# card migration from original_slot# to final_slot#
```

You will receive the following prompt:

```
Are You Sure? [Yes|No]:
```

**Step 2** Press **Y** to start the migration.

**Step 3** Verify that the migration was successful by entering the **show card table** command at the Exec mode prompt.

Check the entry in the *Oper State* column next to the packet processing card that was just migrated from. Its state should be *Standby*. The state of the packet processing card migrated to should be *Active*.

Use the **show rct stats verbose** command to review planned recovery (migration) statistics.

---

## Halting Cards

Cards other than MIO/UMIOMIO2s that are in either the Active or Standby modes can be halted. Halting these cards places them into the "offline" mode. In this mode, the card is unusable for session processing as either an active or redundant component.

If a card in the active mode is halted, its tasks, processes, or network connections will be migrated or switched to a redundant component prior to entering the offline mode.

This section describes how to initiate a card halt and restore halted components.

## Initiate a Card Halt




---

**Important** Do not initiate a **card halt** for an active FSC if there are less than two active FSCs in the system. The system returns an error message if there are less than two active FSCs. There are similar restrictions when executing the **card reboot** or **card upgrade** commands on active FSCs. Refer to the *Command Line Interface Reference* for detailed information.

---

Follow the instructions below to manually initiate a card halt. These instructions assume you are at the root prompt for the Exec mode.

---

**Step 1** Initiate a manual card migration by entering the following command:

```
[local]host_name# card halt slot#
```

*slot#* is the chassis slot number in which the card to be halted is installed. It can be any integer from 1 through 4, and 7 through 18. You will receive the following prompt:

```
Are You Sure? [Yes|No]:
```

**Step 2** Press **Y** to initiate the halt operation.

**Step 3** Verify that the migration was successful by entering the **show card table** command at the Exec mode prompt.

Check the entry in the *Oper State* column next to the card that was just halted. Its state should be *Offline*. If the card was in active mode prior to the execution of this command, the state of the redundant component associated with it should now be *Active*.

---

## Restore a Previously Halted Card

Follow the instructions below to restore a card that was previously halted. These instructions assume you are at the root prompt for the Exec mode.

---

**Step 1** Reboot the card to be restored by entering the following command.

```
[local]host_name# card reboot slot# -force
```

You will receive the following prompt:

```
Are You Sure? [Yes|No]:
```

**Step 2** Press **Y** to start the reboot of the card.

**Step 3** Verify that the migration was successful by entering the **show card table** command at the prompt.

Check the entry in the *Oper State* column next to the card that was just restored. Its state should be the state of that it was in before it was halted.

---

## Verifying Network Connectivity

There are multiple commands supported by the system to verify and/or troubleshoot network connectivity. Note that network connectivity can only be tested once system interfaces and ports have been configured and bound.

The commands specified in this section should be issued on a context-by-context basis. Contexts act like virtual private networks (VPNs) that operate independently of other contexts. Ports, interfaces, and routes configured in one context cannot be tested from another context without additional configuration.

To switch between contexts enter the following command at the root prompt for the Exec mode:

```
[local]host_name# context context_name
```

*context\_name* is the name of the context to which you wish to switch. The following prompt appears:

```
[context_name]host_name#
```

## Using the ping or ping6 Command

The **ping** or **ping6** command verifies the system's ability to communicate with a remote node in the network by passing data packets between and measuring the response. This command is useful in verifying network routing and if a remote node is able to respond at the IP layer.

### Syntax

The **ping** command has the following syntax:

```
ping host_ipv4_address [count num_packets] [flood] [pattern packet_pattern]
[size octet_count] [src { src_host_name | src_host_ipv4_address }] [vrf vrf_name
]
```

```
ping6 host_ipv6_address [count num_packets] [flood] [pattern packet_pattern]
[size octet_count] [src { src_host_name | src_host_ipv6_address }] [vrf vrf_name
]
```

For complete information on the above commands, see the *Exec Mode Commands* chapter of the *Command Line Interface Reference*.

The following displays a sample of a successful **ping** (IPV4) response.

```
PING 192.168.250.1 (192.168.250.1): 56 data bytes
64 bytes from 192.168.250.1: icmp_seq=0 ttl=255 time=0.4 ms
64 bytes from 192.168.250.1: icmp_seq=1 ttl=255 time=0.2 ms
64 bytes from 192.168.250.1: icmp_seq=2 ttl=255 time=0.2 ms
64 bytes from 192.168.250.1: icmp_seq=3 ttl=255 time=0.2 ms
64 bytes from 192.168.250.1: icmp_seq=4 ttl=255 time=0.2 ms
--- 192.168.250.1 ping statistics ---
5 packets transmitted, 5 packets received, 0% packet loss
round-trip min/avg/max = 0.2/0.2/0.4 ms
```

### Troubleshooting

If no response is received from the target follow these troubleshooting procedures:

- Verify that the correct IP address was entered.

- Attempt to ping a different device on the same network. If the ping was successful then it is likely that your system configuration is correct. Verify that the device you are attempting to ping is powered and functioning properly.
- Verify the port is operational.
- Verify that the configuration of the ports and interfaces within the context are correct.
- If the configuration is correct and you have access to the device that you're attempting to ping, ping the system from that device.
- If there is still no response, it is likely that the packets are getting discarded by a network device. Use the **traceroute** or **traceroute6** and **show ip static-route** commands discussed in this chapter to further troubleshoot the issue.

## Using the traceroute or traceroute6 Command

The **traceroute** or **traceroute6** command collects information on the route data will take to a specified host. This is a useful troubleshooting command that can be used to identify the source of significant packet delays or packet loss on the network. This command can also be used to identify bottle necks in the routing of data over the network.

### traceroute – IPv4

The **traceroute** command has the following syntax:

```
traceroute { host_name | host_ipv4_address } [count packets] [df] [maxttl max_ttl] [minttl min_ttl] [port port_number] [size octet_count] [src { src_host_name | src_host_ipv4_address }] [timeout seconds] [vrf vrf_nam]
```

For complete information on the above command, see the *Exec Mode Commands* chapter of the *Command Line Interface Reference*.

The following displays a sample output.

```
traceroute to 192.168.250.1 (192.168.250.1), 30 hops max, 40 byte packets
 1 192.168.250.1 (192.168.250.1) 0.446 ms 0.235 ms 0.178 ms
```

### traceroute6 – IPv6

The **traceroute6** command has the following syntax:

```
traceroute6 { host_name | host_ipv6_address } [count packets] [maxttl max_ttl] [port port_number] [size octet_count] [src { src_host_name | src_host_ipv6_address }] [timeout seconds] [vrf vrf_nam]
```

For complete information on the above commands, see the *Exec Mode Commands* chapter of the *Command Line Interface Reference*.

The following displays a sample output.

```
traceroute6 to 2001:4A2B::1f3F (2001:4A2B::1f3F), 30 hops max, 40 byte packets
 1 2001:4A2B::1f3F (2001:4A2B::1f3F) 0.446 ms 0.235 ms 0.178 ms
```



## Viewing IP Routes

The system provides a mechanism for viewing route information to a specific node or for an entire context. This information can be used to verify network connectivity and to ensure the efficiency of the network connection. The command has the following syntax:

```
show ip route [route_ip_address]
show ipv6 route [route_ipv6_address]
```

For complete information on the above commands, see the *Exec Mode show Commands* chapter of the *Command Line Interface Reference*.

If no keywords are specified, all IP routes within the context's routing table are displayed.

The following displays a sample of this command's output showing a context IPv4 routing table.

```
"" indicates the Best or Used route.
 Destination Nexthop Protocol Prec Cost Interface
*0.0.0.0/0 10.0.4.1 static 0 0 SPIO1
*10.0.4.0/24 0.0.0.0 kernel 0 0 SPIO1
*10.0.4.0/32 0.0.0.0 kernel 0 0 SPIO1
*10.0.4.3/32 0.0.0.0 kernel 0 0 SPIO1
*10.0.4.255/32 0.0.0.0 kernel 0 0 SPIO1
```

## Viewing the Address Resolution Protocol Table

The system provides a mechanism for viewing Address Resolution Protocol (ARP) table information to a specific node or for an entire context. This information can be used to verify that when the system sends an ARP packet, it receives valid responses from other network nodes.

```
[local]host_name# show ip arp [arp_ip_address]
```

*arp\_ip\_address* specifies a specific network node for which to display ARP information. The address can be entered in IPv4 dotted-decimal or IPv6 colon-separated-hexadecimal notation. If this keyword is not specified, all entries within the context's ARP table are displayed.



### Important

Restarting the VPN Manager removes all interfaces from the kernel which in turn removes all ARP entries. However, the NPU still retains all of the ARP entries so that there is no traffic disruption. From a user point of view, **show ip arp** is broken since this command gathers information from the kernel and not the NPU.

The following displays a sample of this command's output showing a context's ARP table.

```
Flags codes:
C - Completed, M - Permanent, P - Published, ! - Not answered
T - has requested trailers
Address Link Type Link Address Flags Mask Interface
10.0.4.240 ether 00:05:47:02:20:20 C MIO1
10.0.4.7 ether 00:05:47:02:03:36 C MIO1
10.0.4.1 ether 00:01:30:F2:7F:00 C MIO1
```

## Using the System Diagnostic Utilities

The system provides protocol monitor and test utilities that are useful when troubleshooting or verifying configurations. The information generated by these utilities can help identify the root cause of a software or network configuration issue.

This section describes how to use these utilities.




---

**Important** Only an administrator with Operator or higher privilege can run the diagnostic utilities described in this section.

---

## Using the Monitor Utility

For troubleshooting purposes, the system provides a protocol monitoring utility. This tool displays protocol information for a particular subscriber session or for every session being processed.




---

**Caution** The monitor tool may cause session processing delays and/or data loss. Therefore, it should be used only when troubleshooting.

---

## Using the Protocol Monitor

The protocol monitor displays information for every session that is currently being processed. Depending on the number of protocols monitored, and the number of sessions in progress, a significant amount of data is generated. It is highly recommended that logging be enabled on your terminal client in order to capture all of the information that is generated.

Refer also to [Packet Capture \(PCAP\) Trace, on page 259](#) to enable PCAP functionality for the **monitor protocol** and **monitor subscriber** commands.

Follow the instructions below to invoke and configure the protocol monitoring tool.

---

**Step 1** Invoke the protocol monitor from the Exec mode by entering the **monitor protocol** command.

```
[local]host_name# monitor protocol
```

An output listing all the currently available protocols, each with an assigned number, is displayed.

**Step 2** Choose the protocol that you wish to monitor by entering the associated number at the *Select:* prompt. A right arrow (>) appears next to the protocol you selected.

**Step 3** Repeat *step 2* as needed to choose multiple protocols.

**Step 4** Press **B** to begin the protocol monitor.

```
WARNING!!! You have selected options that can DISRUPT USER SERVICE
Existing CALLS MAY BE DROPPED and/or new CALLS MAY FAIL!!!
(Under heavy call load, some debugging output may not be displayed)
Proceed? - Select (Y)es or (N)o
```

**Step 5** Enter **Y** to proceed with the monitor or **N** to go back to the previous menu.

```

C - Control Events (ON)
D - Data Events (ON)
E - EventID Info (ON)
H - Display ethernet (ON)
I - Inbound Events (ON)
O - Outbound Events (ON)
S - Sender Info (OFF)
T - Timestamps (ON)
X - PDU Hexdump (OFF)
A - PDU Hex/Ascii (OFF)
+/- Verbosity Level (1)
L - Limit Context (OFF)
M - Match Newcalls (ON)
R - RADIUS Dict (no-override)
G - GTPP Dict (no-override)
Y - Multi-Call Trace ((OFF))
(Q)uit, <ESC> Prev Menu, <SPACE> Pause, <ENTER> Re-Display Options

```

**Step 6** Configure the amount of information that is displayed by the monitor. To enable or disable options, enter the letter associated with that option (C, D, E, etc.). To increase or decrease the verbosity, use the plus (+) or minus (-) keys. The current state, ON (enabled) or OFF (disabled), is shown to the right of each option.

**Step 7** Press the **Enter** key to refresh the screen and begin monitoring.

---

The monitor remains active until disabled. To quit the protocol monitor and return to the prompt, press **q**.

## Using the Protocol Monitor for a Specific Subscriber

The protocol monitor can be used to display information for a specific subscriber session that is currently being processed. Depending on the number of protocols monitored, and the number of sessions in progress, a significant amount of data is generated. It is highly recommended that logging be enabled on your terminal client in order to capture all of the information that is generated.

Follow the instructions in this section to invoke and configure the protocol monitoring tool for a specific subscriber session.

**Step 1** To invoke the session-specific protocol monitor from the Exec mode enter the **monitor subscriber** command.

```

[local]host_name# monitor subscriber { callid | imei | imsi | ipaddr | ipv6addr |
msid | msisdn | next-call | pcf | peer-fa | peer-lac | sgsn-address | type |
username }

```

**Step 2** Specify the method the monitor should use by entering the appropriate keyword.

**Step 3** Select other options and/or enter the appropriate information for the selected keyword.

If no session matching the specified criteria was being processed when the monitor was invoked, a screen of available monitoring options appears.

**Step 4** Configure the amount of information that is displayed by the monitor. To enable or disable options, enter the letter or 2-digit number associated with that option (C, D, E, 11, 12, etc.). To increase or decrease the verbosity, use the plus (+) or minus (-) keys.

The current state, ON (enabled) or OFF (disabled), is shown to the right of each option.

Option **Y** for performing multi-call traces is only supported for use with the GGSN.

**Step 5** Repeat *step 6* as needed to enable or disable multiple protocols.

**Step 6** Press **Enter** to refresh the screen and begin monitoring.

The following displays a portion of a sample of the monitor's output for a subscriber named *user2@aaa*. The default protocols were monitored.

```

Incoming Call:

MSID: 0000012345 Callid: 002dc6c2
Username: user2@aaa SessionType: unknown
Status: Active Service Name: xxxl
Src Context: source Dest Context:

<<<<OUTBOUND 10:02:35:415 Eventid:25001(0)
PPP Tx PDU (9)
PAP 9: Auth-Ack(1), Msg=

<<<<OUTBOUND 10:02:35:416 Eventid:25001(0)
PPP Tx PDU (14)
IPCP 14: Conf-Req(1), IP-Addr=192.168.250.70

<<<<OUTBOUND 10:02:35:416 Eventid:25001(0)
PPP Tx PDU (27)
CCP 27: Conf-Req(1), MPPC, Stac-LZS, Deflate, MVRCA

INBOUND>>>> 10:02:35:517 Eventid:25000(0)
PPP Rx PDU (30)
IPCP 30: Conf-Req(1), IP-Comp VJ-Comp, IP-Addr=0.0.0.0, Pri-DNS=0.0.0.0,
Sec-DNS=0.0.0.0

<<<<OUTBOUND 10:02:35:517 Eventid:25001(0)
PPP Tx PDU (26)
IPCP 26: Conf-Rej(1), IP-Comp VJ-Comp, Pri-DNS=0.0.0.0, Sec-DNS=0.0.0.0

INBOUND>>>> 10:02:35:517 Eventid:25000(0)
PPP Rx PDU (12)
IPCP 12: Conf-Ack(1), IP-Addr=192.168.250.70

INBOUND>>>> 10:02:35:518 Eventid:25000(0)
PPP Rx PDU (31)
LCP 31: Prot-Rej(1), Rejected-Protocol=CCP (0x80fd)

INBOUND>>>> 10:02:35:518 Eventid:25000(0)
PPP Rx PDU (12)
IPCP 12: Conf-Req(2), IP-Addr=0.0.0.0

<<<<OUTBOUND 10:02:35:518 Eventid:25001(0)
PPP Tx PDU (14)
IPCP 14: Conf-Nak(2), IP-Addr=192.168.250.87

INBOUND>>>> 10:02:35:519 Eventid:25000(0)
PPP Rx PDU (12)
IPCP 12: Conf-Req(3), IP-Addr=192.168.250.87
```

The monitor remains active until disabled. To quit the protocol monitor and return to the prompt, press **q**.

## Generating an SSD

An SSD is an instance of the output when the Exec mode **show support details** command is run. It displays a comprehensive list of system information that is useful for troubleshooting purposes. In most cases, the output of this command is requested by the Technical Assistance Center (TAC).

An SSD output .tar file can be redirected to a local or remote location (URL).

The .tar file includes:

- **support\_summary** - An ASCII text file that contains the support detail information.
- **information.minicores.tar** - A .tar file that contains any minicore files found on the system. Minicore files contain memory core dumps that are captured during some events. These core dumps provide specific memory locations and other information about the event. This information is useful to the technical support team in identifying where and when an event occurred along with its probable cause.

The **show support details** command includes information that is not otherwise accessible to users but that is helpful in the swift resolution of issues by TAC.



### Important

Platforms with large configuration files can take up to 30 minutes to complete an SSD. Executing the **show support details** command consumes system resources and may reduce traffic throughput.

*For releases prior to 20.0*, an operator could initiate another SSD while an SSD was already running. In a large configuration, the SSD request often timed out while waiting for the first one to complete. The operator was not aware of the failure until the entire timeout expired. An operator could have more than one SSD running simultaneously.

*For release 20.0 and higher*, if an SSD is in progress when the operator enters the **show support details** command, StarOS responds with a warning message stating that an SSD is already in progress and the user should try again later. The operator is restricted to running only one SSD instance at a time.

There are optional keywords to the **show support details** command that can target the SSD to only report specific type of information. These keywords can reduce the amount of time required to generate the SSD/

For additional information about the **show support details** command, see the *Exec Mode show Commands (Q-S)* chapter in the *Command Line Interface Reference*.

## Configuring and Using the Support Data Collector

The task of collecting the support data is performed by a background CLI task called the record collector. The administrator configures the Support Data Collector (SDC) via the CLI with the commands to be executed on a periodic basis. The record collector always runs in the background and checks if there are records to be collected.

When it is time to collect support data, the scheduler executes the configured sequence of CLI commands and stores the results in a gunzipped (.gz) file on the hard-disk. This file is called an SDR (Support Data Record), and represents a snapshot of the overall state of the system at that time.

Technical Assistance Center (TAC) personnel and local administrators can review the SDRs on-line or by transferring them off the system. They may also wish to investigate the collector state information.

Refer to the *Support Data Collector* chapter for a complete description of SDC functionality.



# CHAPTER 17

## Packet Capture (PCAP) Trace

- [Feature Information, on page 259](#)
- [Feature Description, on page 260](#)
- [Configuring PCAP Trace, on page 260](#)
- [Monitoring and Troubleshooting PCAP Trace, on page 267](#)

### Feature Information

#### Summary Data

Applicable Product(s) or Functional Area	<ul style="list-style-type: none"><li>• ePDG</li><li>• IPSec</li><li>• MME</li><li>• SaMOG</li></ul>
Applicable Platform(s)	ASR 5500 vPC-SI vPC-DI
Feature Default	Disabled
Related Changes in This Release	Not Applicable
Related Documentation	<ul style="list-style-type: none"><li>• <i>ASR 5000 System Administration Guide</i></li><li>• <i>ASR 5500 System Administration Guide</i></li><li>• <i>Command Line Interface Reference Guide</i></li><li>• <i>ePDG Administration Guide</i></li><li>• <i>IPSec Reference Guide</i></li><li>• <i>SaMOG Administration Guide</i></li><li>• <i>VPC-SI System Administration Guide</i></li></ul>

## Revision History



**Important** Revision history details are not provided for features introduced before release 21.2.

Revision Details	Release
PCAP Tracing support for MME S1-AP interface is added in this release.	21.4
First introduced.	21.2

## Feature Description

This feature enables the output of the **monitor subscriber** and **monitor protocol** commands to be captured using the packet capture (PCAP) functionality. The output can be stored in a text file in a hard disk, and later transferred to an external server through SFTP using a PUSH or PULL method. The text file can then be converted to a pcap file using external tools such as text2pcap, or imported directly as PCAP using packet analyzer tools such as wireshark.

PCAP trace and hexdump file collection can be enabled or disabled under the **monitor protocol** and **monitor subscriber** commands. For more information, refer *Enabling or Disabling Hexdump* section of this chapter.

## Configuring PCAP Trace

### Enabling Multiple Instances of CDRMOD

Use the following configuration to enable multiple instances of CDRMOD (one per packet processing card):

```
config
 cdr-multi-mode
end
```

#### Notes:

- Although hexdump record generation is supported on both single-mode and multi-mode, it is recommended to enable the CDR multi-mode.



**Important** After you configure the **cdr-multi-mode** CLI command, you must save the configuration and then reload the chassis for the command to take effect. For information on saving the configuration file and reloading the chassis, refer to the *System Administration Guide* for your deployment.

- Use the **default cdr-multi-mode** command to configure this command with its default setting.





**Important** After you configure the **default cdr-multi-mode** CLI command, you must save the configuration and then reload the chassis for the command to take effect. For information on saving the configuration file and reloading the chassis, refer to the *System Administration Guide* for your deployment.

- **Default:** Single CDRMOD mode

## Configuring the Hexdump Module

Use the following configuration to specify the handling characteristics of the hexdump files:

```
config
 context context_name
 hexdump-module
 hexdump { purge { storage-limit megabytes | time-limit seconds } [
max-files max_records] | push-interval interval | push-trigger
space-usage-percent trigger_percent | remove-file-after-transfer |
transfer-mode { pull [module-only] | push primary { encrypted-url | url
} url [secondary { encrypted-secondary-url | secondary-url } secondary_url
] [via local-context] [max-files files] [max-tasks max_tasks] [
module-only] } | use-harddisk }
 end
```

### Notes:

- Use the **default hexdump [ purge | push-interval | push-trigger | space-usage-percent ] | remove-file-after-transfer | transfer-mode [ module-only ] | use-harddisk** + command to configure the keywords to its the default setting.
  - **purge:** Not enabled
  - **push-interval:** 60 seconds
  - **push-trigger:** 80 percent
  - **remove-file-after-transfer:** Disabled
  - **transfer mode:** PUSH
  - **use-harddisk:** Disabled
- Use the **no hexdump [ purge | remove-file-after-transfer | use-harddisk ]** + command to disable the configured hexdump file storage and processing.
  - **purge:** Disables the deleting of record files on the hard disk based on a storage limit or a time limit.
  - **remove-file-after-transfer:** Retains a copy of the file even after it has been pushed or pulled to another server.
  - **use-harddisk:** Disables data storage on the system's hard disk.

- Use the **purge** { **storage-limit** *megabytes* | **time-limit** *seconds* } [ **max-files** *max\_records* ] keywords to configure parameters for deleting hexdump records from the hard drive. This command is not enabled by default.
  - **storage-limit** *megabytes*: Specifies that hexdump records are to be deleted from the hard drive upon reaching a storage limit defined in megabytes.  
*bytes* must be an integer from 10 through 143360.
  - **time-limit** *seconds*: Specifies that hexdump records are to be deleted from the hard drive upon reaching a time limit defined in seconds.  
*seconds* must be an integer from 600 through 2592000.
  - **max-files** *max\_records*: Specifies the maximum number of files to purge. If configured to 0, all records will be purged until the limit is reached.  
*max\_records* must be an integer that is of value 0, or from 1000 through 10000.
- Use the **push-interval** *interval* keyword to specify the transfer interval (in seconds) when hexdump files will be pushed to an external file server.
  - *interval* must be an integer from 30 through 3600.
  - **Default**: 60
- Use the **push-trigger space-usage-percent** *trigger\_percent* to specify the disk space utilization percentage threshold at which an automatic push is triggered and files are transferred to the external server.
  - *trigger\_percent* must be an integer from 10 through 80.
  - **Default**: 80
- Use the **remove-file-after-transfer** keyword to specify that the system must delete hexdump files after they have been transferred to the external file server.

Default: Disabled.




---

**Important** This keyword must be enabled for hexdump records.

---

- Use the **transfer-mode** { **pull** [ **module-only** ] | **push** **primary** { **encrypted-url** | *url* } *url* [ **secondary** { **encrypted-secondary-url** | **secondary-url** } *secondary\_url* ] [ **via local-context** ] [ **max-files** *files* ] [ **max-tasks** *max\_tasks* ] [ **module-only** ] } keywords to specify the transfer mode to be used when transferring hexdump files to an external file server
  - **pull**: Specifies that the destination server (external storage) will pull the hexdump files.
  - **push**: Specifies that the system will push hexdump files to the destination server. This is the default mode.
  - **primary encrypted-url** *url*: Specifies the primary URL location to which the system pushes the files in encrypted format.  
*url* must be an alphanumeric string of 1 through 8192 characters.
  - **primary url** *url*: Specifies the primary URL location to which the system pushes the hexdump files.

**url** must be an alphanumeric string of 1 through 1024 characters in the format:  
*//user:password@host:[port]/direct.*

- **secondary encrypted-secondary-url** *secondary\_url*: Specifies the secondary URL location to which the system pushes the files in encrypted format.

*secondary\_url* must be an alphanumeric string of 1 through 8192 characters.

- **secondary secondary-url** *secondary\_url*: Specifies the secondary URL location to which the system pushes the hexdump files.

*secondary\_url* must be an alphanumeric string of 1 through 1024 characters in the format:  
*//user:password@host:[port]/direct.*

- **via local-context**: Specifies that the local context, and, subsequently, the SPIO management ports, will be used to pull or push hexdump files.

- **max-files** *files*: Specifies the maximum number of files that can be transferred per push.

*files* must be an integer from 4 to 4000.

- **max-tasks** *max\_tasks*: Specifies the maximum number of files per push.

*max\_tasks* must be an integer from 4 through 8.

- **module-only**: Specifies that the transfer of hexdump records is to be applied only to the module type for which the configuration was originally created. If this option is not enabled, the transfer will occur for all record types.

- Use the **use-harddisk** keyword to specify that the hard disk drive on the SMC is to be used to store hexdump records.

**Default:** Disabled.




---

**Important** This keyword must be enabled for hexdump records.

---

## Configuring the Hexdump File Parameters

Use the following configuration to specify the format of the hexdump files:

```
config
 context context_name
 hexdump-module
 file [compression { gzip | none } | current-prefix prefix |
delete-timeout seconds | directory directory_name | exclude-checksum-record |
 field-separator { hyphen | omit | underscore } | headers | name file_name
 | reset-indicator | rotation { num-records number | tariff-time minute
minutes hour hours | time seconds | volume bytes } | sequence-number { length
length | omit | padded | padded-six-length | unpadded } | storage-limit
limit | time-stamp { expanded-format | rotated-format | unix-format } |
trailing-text string | trap-on-file-delete | xor-final-record] +
 end
```

**Notes:**

- Use the **default file** [ **compression** | **current-prefix** | **delete-timeout** | **directory** | **field-separator** | **headers** | **name** | **reset-indicator** | **rotation** { **num-records** | **tariff-time** | **time** | **volume** } | **sequence-number** | **storage-limit** | **time-stamp** | **trailing-text** | **trap-on-file-delete** ] + command to configure the default setting for the specified keyword(s).
- Use the **compression** { **gzip** | **none** } keyword to specify the compressions of hexdump files.
  - **gzip**: Enables GNU zip compression of the hexdump file at approximately 10:1 ratio.
  - **none**: Disables Gzip compression.
- Use the **current-prefix** *prefix* keyword to specify a string to add at the beginning of the hexdump file that is currently being used to store records.
  - *prefix* must be an alphanumeric string of 1 through 31 characters.
  - **Default**: curr
- Use the **delete-timeout** *seconds* keyword to specify a time period, in seconds, after which the hexdump files are deleted. By default, files are never deleted.
  - *seconds* must be an integer from 3600 through 31536000.
  - **Default**: Disabled
- Use the **directory** *directory\_name* keyword to specify a subdirectory in the default directory in which to store hexdump files.
  - *directory\_name* must be an alphanumeric string of 0 through 191 characters.
  - **Default**: */records/hexdump*
- Use the **exclude-checksum-record** keyword to exclude the final record containing #CHECKSUM followed by the 32-bit Cyclic Redundancy Check (CRC) of all preceding records from the hexdump file.
 

**Default**: Disabled (a checksum record is included in the hexdump file header)
- Use the **field-separator** { **hyphen** | **omit** | **underscore** } to specify the type of separators between two fields of a hexdump file name:
  - **hyphen**: Specifies the field separator as a "-" (hyphen) symbol between two fields.
  - **omit**: Omits the field separator between two fields.
  - **underscore**: Specifies the field separator as an "\_" (underscore) symbol between two fields.
- Use the **headers** keyword to include a file header summarizing the record layout.
- Use the **name** *file\_name* to specify a string to be used as the base file name for hexdump files.
 

*file\_name* must be an alphanumeric string from 1 through 31 characters.
- Use the **reset-indicator** to specify the inclusion of the reset indicator counter (value from 0 through 255) in the hexdump file name.
 

The counter is incremented whenever any of the following conditions occur:

  - A peer chassis has taken over in compliance with Interchassis Session Recovery (ICSR).

- The sequence number (see **sequence-number** keyword) has rolled over to zero.
- Use the **rotation** { **num-records** *number* | **tariff-time** *minute* *minutes* **hour** *hours* | **time** *seconds* | **volume** *bytes* } keyword to specify when to close a hexdump file and create a new one.
  - **num-records** *number*: Specifies the maximum number of records that should be added to a hexdump file. When the number of records in the file reaches this value, the file is complete.  
*number* must be an integer from 100 through 10240. **Default**: 1024
  - **tariff-time** *minute* *minutes* **hour** *hours*: Specifies to close the current hexdump file and create a new one based on the tariff time (in minutes and hours).  
*minutes* must be an integer from 0 through 59.  
*hours* must be an integer from 0 through 23.
  - **time** *seconds*: Specifies the period of time to wait (in seconds) before closing the current hexdump file and creating a new one.  
*seconds* must be an integer from 30 through 86400. **Default**: 3600




---

**Important** It is recommended to set the rotation time to 30 seconds.

---

- **volume** *bytes*: Specifies the maximum size of the hexdump file (in bytes) before closing it and creating a new one.  
*bytes* must be an integer from 51200 through 62914560. Note that a higher setting may improve the compression ratio when the compression keyword is set to **gzip**. **Default**: 102400
- Use the **sequence-number** { **length** *length* | **omit** | **padded** | **padded-six-length** | **unpadded** } keyword to exclude or include the sequence number with a specified format in the file name.
  - **length** *length*: Includes the sequence number with the specified length.  
*length* must be the file sequence number length with preceding zeroes in the file name, and must be an integer from 1 through 9.
  - **omit**: Excludes the sequence number from the file name.
  - **padded**: Includes the padded sequence number with preceding zeros in the file name. This is the default setting.
  - **padded-six-length**: Includes the padded sequence number with six preceding zeros in the file name.
  - **unpadded**: Includes the unpadded sequence number in the file name.
- Use the **storage-limit** *limit* keyword to set the storage limit. Files will be deleted when the specified amount of space (in bytes) is reached.  
*limit* must be an integer from 10485760 through 268435456.
- Use the **time-stamp** { **expanded-format** | **rotated-format** | **unix-format** } keyword to specify the format of the file creation timestamp to be included in the file name.
  - **expanded-format**: Specifies the UTC (Universal Time Coordinated) MMDDYYYYHHMMSS format.

- **rotated-format**: Specifies the time stamp format to YYYYMMDDHHMMSS format.
- **unix-format**: Specifies the UNIX format of x.y, where x is the number of seconds since 1/1/1970 and y is the fractional portion of the current second that has elapsed.
- Use the **trailing-text** *string* keyword to specify the inclusion of an arbitrary text string in the file name as an alphanumeric string of 1 through 30 characters.  
*string* must be an alphanumeric string from 1 through 30 characters.
- Use the **trap-on-file-delete** keyword to instruct the system to send an SNMP notification (trap) when a hexdump file is deleted due to lack of space.  
**Default:** Disabled
- Use the **xor-final-record** keyword to insert an exclusive OR (XOR) checksum (instead of a CRC checksum) into the hexdump file header, if the exclude-checksum-record is left at its default setting.  
**Default:** Disabled
- The + symbol indicates that more than one of the previous keywords can be entered within a single command.

## Enabling or Disabling Hexdump

Hexdump captures can be enabled for protocols in the **monitor subscriber** and **monitor protocol** commands in the Exec Mode. Subscriber information for PCAP trace can be specified using the filters in the **monitor subscriber** command. For protocols and filters supported for a specific product, refer the respective product Administration and Reference guides.

When the **monitor subscriber** or **monitor protocol** command is running, use the **U** or **V** option to enable hexdump capturing:

- **U - Mon Display (ON)**: Use this option to display message captures on the terminal.
  - **Default:** ON
  - When this option is turned off, monitoring will still run in the background.
- **V - PCAP Hexdump (NONE)**: Use this option to enable or disable capturing hexdump packets globally.
  - **Default:** None
  - **V - PCAP Hexdump (ON)**: Hexdump capture is enabled with the prompt:  
*Warning :Turning ON/OFF will impact other cli logging terminals, You will interrupt others already using hexdump.*
  - **V - PCAP Hexdump (OFF)**: Hexdump capture is disabled (paused).

## Enabling PCAP Trace for MME

This section describes how to enable PCAP trace for MME S1-AP interface and SGsAP interface.

- Under monitor protocol (monpro), enable S1-AP and SGS, or Sctp protocol option along with V - PCAP Hexdump (ON), to capture all S1-AP messages in PCAP hexdump.
- Monitor subscriber (monsub) supports PCAP tracing on S1-AP and SGS filter options.
- When S1-AP or SGS filter option is selected in monpro/monsub, PCAP Hexdump will have dummy Sctp header. The following fields are set as dummy in the Sctp header:
  - Verification tag
  - Checksum
  - Chunk flags
  - Transmission Sequence Numbers (TSN)
  - Stream identifier
  - Stream sequence number
- When the Sctp protocol option is selected in monpro, PCAP hexdump will have the original Sctp header.

# Monitoring and Troubleshooting PCAP Trace

## Show Command(s) and/or Outputs

The show command(s) in this section are available in support of PCAP trace.

### show cdr statistics

The following fields are available in the output of the **show cdr statistics** command in support of this feature:

```
EDR-UDR file Statistics:

CDRMOD Instance Id: 2
Hexdump-module Record Specific Statistics:
Hexdump-module files rotated: 0
Hexdump-module files rotated due to volume limit: 0
Hexdump-module files rotated due to time limit: 0
Hexdump-module files rotated due to tariff-time: 0
Hexdump-module files rotated due to records limit: 0
Hexdump-module file rotation failures: 0
Hexdump-module files deleted: 0
Hexdump-module records deleted: 0
Hexdump-module records received: 0
Current open Hexdump-module files: 0
Time of last Hexdump-module file deletion: 0
```

**Table 34: show cdr statistics Command Output Descriptions**

Field	Description
<b>EDR-UDR file Statistics:</b>	

```
show { hexdump-module | cdr } file-space-usage
```

Field	Description
CDRMOD Instance Id	Indicates the CDRMOD instance id for which the statistics are collected.
<b>Hexdump-module Record Specific Statistics:</b>	
Hexdump-module files rotated	Total number of times a hexdump file was closed and a new hexdump file was created.
Hexdump-module files rotated due to volume limit	Total number of times a hexdump file was closed and a new hexdump file was created since the volume limit was reached.
Hexdump-module files rotated due to time limit	Total number of times a hexdump file was closed and a new hexdump file was created since the time limit was reached.
Hexdump-module files rotated due to tariff-time	Total number of times a hexdump file was closed and a new hexdump file was created since the tariff time was reached.
Hexdump-module files rotated due to records limit	Total number of times a hexdump file was closed and a new hexdump file was created since the records limit was reached.
Hexdump-module file rotation failures	Total number of times hexdump file rotation failed.
Hexdump-module files deleted	Total number of times hexdump files were deleted.
Hexdump-module records deleted	Total number of times hexdump records were deleted.
Hexdump-module records received	Total number of times hexdump records were received.
Current open Hexdump-module files	Total number of hexdump files currently open.
Time of last Hexdump-module file deletion	Time of the last deleted hexdump file.

## show { hexdump-module | cdr } file-space-usage

The following fields are available in the output of the `show { hexdump-module | cdr } file-space-usage` command in support of this feature:

```
CDRMOD Instance Id: 2
 Hexdump-module File Storage LIMIT : 33554432 bytes
 Hexdump-module File Storage USAGE : 196608 bytes
 Percentage of Hexdump-module file store usage : 0.585938
```

**Table 35: show { hexdump-module | cdr } file-space-usage Command Output Descriptions**

Field	Description
CDRMOD Instance Id	Indicates the CDRMOD instance id for which the statistics are collected.
Hexdump-module File Storage LIMIT	Indicates the maximum storage space (in bytes) that can be used for hexdump files.



Field	Description
Hexdump-module File Storage USAGE	Indicates the total storage space (in bytes) used for hexdump files.
Percentage of Hexdump-module file store usage	Indicates the total percentage of storage used for hexdump files.

## show hexdump-module statistics

The following fields are available in the output of the **show hexdump-module statistics** command in support of this feature.

Hexdump-module-Record file Statistics:

```

CDRMOD Instance Id: 2
Hexdump-module files rotated: 0
Hexdump-module files rotated due to volume limit: 0
Hexdump-module files rotated due to time limit: 0
Hexdump-module files rotated due to tariff-time: 0
Hexdump-module files rotated due to records limit: 0
Hexdump-module file rotation failures: 0
Hexdump-module files deleted: 0
Hexdump-module records deleted: 0
Hexdump-module records received: 0
Current open Hexdump-module files: 0
Time of last Hexdump-module file deletion: 0
```

Hexdump-module PUSH Statistics:

```

Successful File Transfers : 0
Failed File Transfers : 0
Num of times PUSH initiated : 0
Num of times PUSH Failed : 0
Num of times PUSH cancelled
 due to HD failure : 0
Num of periodic PUSH : 0
Num of manual PUSH : 0
Current status of PUSH : Not Running
Last completed PUSH time : N/A
```

Primary Server Statistics:

```
Successful File Transfers : 0
Failed File Transfers : 0
Num of times PUSH initiated : 0
Num of times PUSH Failed : 0
Num of periodic PUSH : 0
Num of manual PUSH : 0
Current status of PUSH : Not Running
Last completed PUSH time : N/A
```

Secondary Server Statistics:

```
Successful File Transfers : 0
Failed File Transfers : 0
Num of times PUSH initiated : 0
Num of times PUSH Failed : 0
Num of periodic PUSH : 0
Num of manual PUSH : 0
Current status of PUSH : Not Running
Last completed PUSH time : N/A
```

**Important**

Use the **clear hexdump-module statistics** command under the Exec Mode to clear and reset the hexdump module statistics.

**Table 36: show hexdump-module statistics Command Output Descriptions**

Field	Description
<b>Hexdump-module-Record file Statistics:</b>	
CDRMOD Instance Id	Indicates the CDRMOD instance id for which the statistics are collected.
Hexdump-module files rotated	Total number of times a hexdump file was closed and a new hexdump file was created.
Hexdump-module files rotated due to volume limit	Total number of times a hexdump file was closed and a new hexdump file was created since the volume limit was reached.
Hexdump-module files rotated due to time limit	Total number of times a hexdump file was closed and a new hexdump file was created since the time limit was reached.
Hexdump-module files rotated due to tariff-time	Total number of times a hexdump file was closed and a new hexdump file was created since the tariff time was reached.
Hexdump-module files rotated due to records limit	Total number of times a hexdump file was closed and a new hexdump file was created since the records limit was reached.
Hexdump-module file rotation failures	Total number of times hexdump file rotation failed.
Hexdump-module files deleted	Total number of times hexdump files were deleted.
Hexdump-module records deleted	Total number of times hexdump records were deleted.
Hexdump-module records received	Total number of times hexdump records were received.
Current open Hexdump-module files	Total number of hexdump files currently open.
Time of last Hexdump-module file deletion	Time of the last deleted hexdump file.
<b>Hexdump-module PUSH Statistics:</b>	
Successful File Transfers	Total number of hexdump files that were successfully transferred.
Failed File Transfers	Total number of hexdump files that failed to transfer.
Num of times PUSH initiated	Total number of times the PUSH operation was initiated.
Num of times PUSH Failed	Total number of times PUSH operation failed.
Num of times PUSH cancelled due to HD failure	Total number of times PUSH operation failed due to hard disk failure.

Field	Description
Num of periodic PUSH	Total number of periodic times PUSH operation was performed.
Num of manual PUSH	Total number of times the PUSH operation was performed manually.
Current status of PUSH	Indicates if the PUSH operation is currently running.
Last completed PUSH time	Indicates the time when the last PUSH operation was completed.
<b>Primary Server Statistics:</b>	
Successful File Transfers	Total number of hexdump files successfully transferred to the primary storage server.
Failed File Transfers	Total number of hexdump files that failed transfer to the primary storage server.
Num of times PUSH initiated	Total number of times PUSH operation was initiated to transfer hexdump files to the primary storage server.
Num of times PUSH Failed	Total number of times PUSH operation failed to transfer hexdump files to the primary storage server.
Num of periodic PUSH	Total number of periodic times PUSH operation was performed to the primary storage server.
Num of manual PUSH	Total number of times the PUSH operation to the primary storage server was performed manually.
Current status of PUSH	Indicates if the PUSH operation to the primary storage server is currently running.
Last completed PUSH time	Indicates the time when the last PUSH operation to the primary storage server was completed.
<b>Secondary Server Statistics:</b>	
Successful File Transfers	Total number of hexdump files successfully transferred to the secondary storage server.
Failed File Transfers	Total number of hexdump files that failed transfer to the secondary storage server.
Num of times PUSH initiated	Total number of times PUSH operation was initiated to transfer hexdump files to the secondary storage server.
Num of times PUSH Failed	Total number of times PUSH operation failed to transfer hexdump files to the secondary storage server.
Num of periodic PUSH	Total number of periodic times PUSH operation was performed to the secondary storage server.

show hexdump-module statistics

Field	Description
Num of manual PUSH	Total number of times the PUSH operation to the secondary storage server was performed manually.
Current status of PUSH	Indicates if the PUSH operation to the secondary storage server is currently running.
Last completed PUSH time	Indicates the time when the last PUSH operation to the secondary storage server was completed.



## CHAPTER 18

# System Recovery

This chapter describes how to recover a system after it has failed to complete a reboot following a power off cycle or interruption of the normal boot sequence following a **reload** command.



**Caution** This system recovery process interrupts subscriber service by dropping any existing flows and preventing traffic from being processed during the boot interval. It should only be initiated as an emergency measure.

This chapter includes the following sections:

- [Prerequisites, on page 273](#)
- [Accessing the boot CLI, on page 274](#)
- [Booting from a Selected Image, on page 275](#)

## Prerequisites

Recovery from a failed reboot requires that you have access to the system via a console port, and have an uncorrupted copy of the StarOS boot image file stored in flash memory on the management card, or accessible from an external memory device.

## Console Access

Boot recovery can only be executed via a terminal connected to the serial console port on the active management card. This connection can be through a terminal server that is accessible via a LAN interface. Boot recovery can only be viewed via the console port.

## Boot Image

The boot recovery command line interface enables you to specify from which boot image you would like to boot the system. If the system failed to reload following a software update, you can initiate a boot from a previously stored image.

The system recovery process will prompt you to enter the path name for the location of the StarOS boot image from which the system will boot. By default the boot command will timeout and attempt to reload the highest priority image from flash memory using the default configuration file.

The StarOS software is delivered as a single binary file (**.bin** file extension) and is loaded as a single instance for the entire system.

- For StarOS releases prior to 16.1, the image filename is identified by its release version and corresponding build number. Format = **production.build\_number.platform.bin**.
- For StarOS release 16.1 onwards, the image filename is identified by its platform type and release number. Format = **platform-release\_number.bin**.

Refer to the *Configuring the Boot Stack* section in the *Software Management Operations* chapter for additional information on boot stack entries and prioritization.

## Accessing the boot CLI

To access the boot CLI you must interrupt an in-progress reload (reboot) sequence.



### Caution

This system recovery process interrupts subscriber service by dropping any existing flows and preventing traffic from being processed during the boot interval. It should only be initiated as an emergency measure.

## Initiate a Reboot

A reload can be initiated in one of two ways:

- Power cycle the chassis – Turn the circuit breakers on the power filter units (PFUs) Off (O) and then On (I).
- Execute a **reload** command

```
[local]host_name# reload -noconfirm
```

The boot sequence displays messages on the terminal as it steps through its processes.

## Interrupt the Boot Sequence

When the "Booting priority" message line appears (and not before), press CTRL+C to break out of the boot process as shown in the example below:

```
Booting priority 8
 image : /flash/image_filename.bin
 config: /flash/system.cfg
Entry at 0x00000000cba45e0
```

Press CTRL+C at this point in the sequence.

A message similar to the following appears after the boot process has been interrupted:

```
*****9/0 Ctrl-C Pressed-----
Failed.
 aborted by user
8/0:boot>
```

## Enter CLI Mode

With the boot prompt displayed, enter **cli** to access the boot recovery CLI. The CLI prompt changes as shown below:

```
8/0:boot>cli
8/0:cli>
```

## boot Command Syntax

The boot recovery command has the following syntax:

```
boot [-show | -priority=* | -config=* | -noconfig] { bootfile_URL }
```

The options for this command include:

- **-show**: displays the current boot configuration
- **-priority=\***: selects the desired boot stack priority (\*)
- **-config=\***: enters the desired configuration filename (\*), if not the default file
- **-noconfig**: boots using no configuration file

**bootfile\_URL** is the URL for the location of the StarOS boot image file. It specifies the path and file name of the StarOS .bin file from which the system will be booted.

The URL may refer to a local file (flash) or an external file on a memory device attached to the management card. The URL must be entered in the following format:

```
{ /flash | /pcmcia1 | /usb1 }/filename
```

## Booting from a Selected Image

You will issue a **boot** command via the boot CLI to initiate the system recovery process.

## Boot Using No Configuration File

This procedure boots the system using the specified boot image without also loading a configuration file. A sample command string appears below:

```
8/0:cli>boot -noconfig /flash/image_filename.bin
```

The boot sequence ends with a prompt to enter the Quick Setup Wizard for creating a configuration file.

```
Launching StarOS
Starting program at 0x0000000000100000
Starent Networks ASR5500 Intelligent Mobile Gateway
management_card is starting up.....
Starting software image_version_number...
No configuration found, press enter to continue.
1. Do you wish to continue with the Quick Setup Wizard[yes/no]:
```

You can exit the Quick Setup Wizard by entering **no** in response to the above prompt. Load a desired configuration file using the Exec mode **configure** command followed by the URL for the configuration file as shown in the example below:

```
[local]host_name# configure /flash/system.cfg
```

## Boot Using A Specified Configuration File

This procedure boots the system using the specified boot image and configuration file. A sample command string appears below:

```
8/0:cli>boot -config=/flash/system.cfg /flash/image_filename.bin
```

The boot sequence ends with the appearance of the CLI prompt.

```
[local]host_name#
```

Confirm that the desired configuration has loaded by running the Exec mode **show configuration** command.





# CHAPTER 19

## Access Control Lists

This chapter describes system support for access control lists and explains how they are configured. The product administration guides provide examples and procedures for configuration of basic services on the system. You should select the configuration example that best meets your service model before using the procedures described below.



---

**Important**

You do not require a license to configure ACLs. However, the number of ACLs configured may impact performance significantly.

---



---

**Important**

Not all commands and keywords/variables may be available. Availability depends on the platform type.

---

This chapter contains the following sections:

- [Overview, on page 277](#)
- [Understanding ACLs, on page 278](#)
- [Configuring ACLs on the System, on page 280](#)
- [Applying IP ACLs, on page 282](#)

## Overview

IP access lists, commonly known as access control lists (ACLs), control the flow of packets into and out of the system. They are configured on a per-context basis and consist of "rules" (ACL rules) or filters that control the action taken on packets that match the filter criteria. Once configured, an ACL can be applied to any of the following:

- An individual interface
- All traffic facilitated by a context (known as a policy ACL)
- An individual subscriber
- All subscriber sessions facilitated by a specific context

Separate ACLs may be created for IPv4 and IPv6 access routes.

# Understanding ACLs

This section discusses the two main aspects to ACLs on the system:

- [Rule\(s\), on page 278](#)
- [Rule Order, on page 279](#)



## Important

Refer to *ACL Configuration Mode Commands* and the *IPv6 ACL Configuration Mode Commands* chapter in the *Command Line Interface Reference* for the full command syntax.

## Rule(s)

A single ACL consists of one or more ACL rules. Each rule is a filter configured to take a specific action when packets matching specific criteria. Up to 256 rules can be configured per ACL.



## Important

Configured ACLs consisting of no rules imply a "deny any" rule. The **deny** action and **any** criteria are discussed later in this section. This is the default behavior for an empty ACL.

Each rule specifies the action to take when a packet matches the specifies criteria. This section discusses the rule actions and criteria supported by the system.

## Actions

ACLs specify that one of the following actions can be taken on a packet that matches the specified criteria:

- **Permit:** The packet is accepted and processed.
- **Deny:** The packet is rejected.
- **Redirect:** The packet is forwarded to the specified next-hop address through a specific system interface or to the specified context for processing.



## Important

Redirect rules are ignored for ACLs applied to specific subscribers or all subscribers facilitated by a specific context, or APN for UMTS subscribers.

## Criteria

Each ACL consists of one or more rules specifying the criteria that packets will be compared against.

The following criteria are supported:

- **Any:** Filters all packets
- **Host:** Filters packets based on the source host IP address
- **ICMP:** Filters Internet Control Message Protocol (ICMP) packets

- **IP:** Filters Internet Protocol (IP) packets
- **Source IP Address:** Filter packets based on one or more source IP addresses
- **TCP:** Filters Transport Control Protocol (TCP) packets
- **UDP:** Filters User Datagram Protocol (UDP) packets

Each of the above criteria are described in detail in the sections that follow.

**Important**

The following sections contain basic ACL rule syntax information. Refer to the *ACL Configuration Mode Commands* and *IPv6 ACL Configuration Mode Commands* chapters in the *Command Line Interface Reference* for the full command syntax.

- **Any:** The rule applies to all packets.
- **Host:** The rule applies to a specific host as determined by its IP address.
- **ICMP:** The rule applies to specific Internet Control Message Protocol (ICMP) packets, Types, or Codes. ICMP type and code definitions can be found at [www.iana.org](http://www.iana.org) (RFC 3232).
- **IP:** The rule applies to specific Internet Protocol (IP) packets or fragments.
- **IP Packet Size Identification Algorithm:** The rule applies to specific Internet Protocol (IP) packets identification for fragmentation during forwarding.

This configuration is related to the "IP Identification field" assignment algorithm used by the system, when subscriber packets are being encapsulated (such as Mobile IP and other tunneling encapsulation). Within the system, subscriber packet encapsulation is done in a distributed way and a 16-bit IP identification space is divided and distributed to each entity which does the encapsulation, so that unique IP identification value can be assigned for IP headers during encapsulation.

Since this distributed IP Identification space is small, a non-zero unique identification will be assigned only for those packets which may potentially be fragmented during forwarding (since the IP identification field is only used for reassembly of the fragmented packet). The total size of the IP packet is used to determine the possibility of that packet getting fragmented.

- **Source IP Address:** The rule applies to specific packets originating from a specific source address or a group of source addresses.
- **TCP:** The rule applies to any Transport Control Protocol (TCP) traffic and could be filtered on any combination of source/destination IP addresses, a specific port number, or a group of port numbers. TCP port numbers definitions can be found at [www.iana.org](http://www.iana.org)
- **UDP:** The rule applies to any User Datagram Protocol (UDP) traffic and could be filtered on any combination of source/destination IP addresses, a specific port number, or a group of port numbers. UDP port numbers definitions can be found at [www.iana.org](http://www.iana.org).

## Rule Order

A single ACL can consist of multiple rules. Each packet is compared against each of the ACL rules, in the order in which they were entered, until a match is found. Once a match is identified, all subsequent rules are ignored.

Additional rules can be added to an existing ACL and properly ordered using either of the following options:

- Before
- After

Using these placement options requires the specification of an existing rule in the ACL and the configuration of the new rule as demonstrated by the following flow:

```
[before | after] { existing_rule }
```

## Configuring ACLs on the System

This section describes how to configure ACLs.




---

**Important** This section provides the minimum instruction set for configuring access control list on the system. For more information on commands that configure additional parameters and options, refer to the *ACL Configuration Mode Commands* and *IPv6 ACL Configuration Mode Commands* chapters in the *Command Line Interface Reference*.

---

To configure the system to provide an access control list facility to subscribers:

- 
- Step 1** Create the access control list by following the example configuration in [Creating ACLs, on page 280](#)
  - Step 2** Specify the rules and criteria for action in the ACL list by following the example configuration in [Configuring Action and Criteria for Subscriber Traffic, on page 281](#)
  - Step 3** *Optional.* The system provides an "undefined" ACL that acts as a default filter for all packets into the context. The default action is to "permit all". Modify the default configuration for "unidentified" ACLs for by following the example configuration in [Configuring an Undefined ACL, on page 281](#)
  - Step 4** Verify your ACL configuration by following the steps in [Verifying the ACL Configuration, on page 281](#)
  - Step 5** Save your configuration to flash memory, an external memory device, and/or a network location using the Exec mode **save configuration** command. For additional information refer to the *Verifying and Saving Your Configuration* chapter.
- 

## Creating ACLs

To create an ACL, enter the following command sequence from the Exec mode of the system CLI:

```
configure
 context acl_ctxt_name [-noconfirm]
 { ip | ipv6 } access-list acl_list_name
 end
```

Notes:

- The maximum number of ACLs that can be configured per context is limited by the amount of available memory in the VPN Manager software task. Typically, the maximum is less than 200.

## Configuring Action and Criteria for Subscriber Traffic

To create rules to deny/permit the subscriber traffic and apply the rules after or before action, enter the following command sequence from the Exec mode of the system CLI:

```
configure
context acl_ctxt_name [-noconfirm]
 { ip | ipv6 } access-list acl_list_name
 deny { ip_address | any | host | icmp | ip | log | tcp | udp }
 permit { ip_address | any | host | icmp | ip | log | tcp | udp }
 after { deny | permit | readdress | redirect }
 before { deny | permit | readdress | redirect }
 end
```

Notes:



### Caution

The system does not apply a "deny any" rule, unless it is specified in the ACL. This behavior can be changed by adding a "deny any" rule at the end of the ACL.

- The maximum number of rules that can be configured per ACL varies depending on how the ACL is to be used. For more information, refer to the *Engineering Rules* chapter.
- Use the information provided in the [Actions](#) and [Criteria](#) to configure the rules that comprise the ACL. For more information, refer to the *ACL Configuration Mode Commands* and *IPv6 ACL Configuration Mode Commands* chapters in the *Command Line Interface Reference*.

## Configuring an Undefined ACL

As discussed previously the system uses an "undefined" ACL mechanism for filtering the packet(s) in the event that an ACL that has been applied is not present. This scenario is likely the result of a mis-configuration such as the ACL name being mis-typed during the configuration process.

For these scenarios, the system provides an "undefined" ACL that acts as a default filter for all packets into the context. The default action is to "permit all".

To modify the default behavior for unidentified ACLs, use the following configuration:

```
configure
context acl_ctxt_name [-noconfirm]
 access-list undefined { deny-all | permit-all }
end
```

Notes:

- Context name is the name of the context containing the "undefined" ACL to be modified. For more information, refer to the *Context Configuration Mode Commands* chapter in the *Command Line Interface Reference*.

## Verifying the ACL Configuration

To verify the ACL configuration, enter the Exec mode `show { ip | ipv6 } access-list` command.

The following is a sample output of this command. In this example, an ACL named *acl\_1* was configured.

```
ip access list acl_1
 deny host 10.2.3.4
 deny ip any host 10.2.3.4
 permit any 10.2.4.4
1 ip access-lists are configured.
```

## Applying IP ACLs

Once an ACL is configured, it must be applied to take effect.



**Important**

All ACLs should be configured and verified according to the instructions in the [Configuring ACLs on the System, on page 280](#) prior to beginning these procedures. The procedures described below also assume that the subscribers have been previously configured.

As discussed earlier, you can apply an ACL to any of the following:

- [Applying an ACL to an Individual Interface, on page 284](#)
- [Applying an ACL to All Traffic Within a Context, on page 285](#) (known as a policy ACL)
- [Applying an ACL to an Individual Subscriber, on page 287](#)
- [Applying a Single ACL to Multiple Subscribers, on page 291](#)
- [Applying a Single ACL to Multiple Subscribers, on page 291](#) (for 3GPP subscribers only)

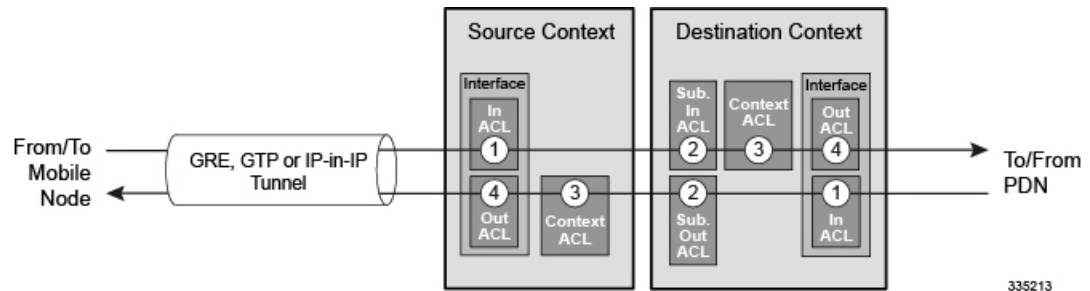


**Important**

ACLs must be configured in the same context in which the subscribers and/or interfaces to which they are to be applied. Similarly, ACLs to be applied to a context must be configured in that context.

If ACLs are applied at multiple levels within a single context (such as an ACL is applied to an interface within the context and another ACL is applied to the entire context), they will be processed as shown in the following figure and table.

**Figure 18: ACL Processing Order**



**Table 37: ACL Processing Order Descriptions**

Packet coming from the mobile node to the packet data network (left to right)	
Order	Description

1	An inbound ACL configured for the receiving interface in the Source Context is applied to the tunneled data (such as the outer IP header). The packet is then forwarded to the Destination Context.
2	An inbound ACL configured for the subscriber (either the specific subscriber or for any subscriber facilitated by the context) is applied.
3	A context ACL (policy ACL) configured in the Destination Context is applied prior to forwarding.
4	An outbound ACL configured on the interface in the Destination Context through which the packet is being forwarded, is applied.
Packet coming from the packet data network to the mobile node (right to left)	
Order	Description
1	An inbound ACL configured for the receiving interface configured in the Destination Context is applied.
2	An outbound ACL configured for the subscriber (either the specific subscriber or for any subscriber facilitated by the context) is applied. The packet is then forwarded to the Source Context.
3	A context ACL (policy ACL) configured in the Source Context is applied prior to forwarding.
4	An outbound ACL configured on the interface in the Source Context through which the packet is being forwarded, is applied to the tunneled data (such as the outer IP header).

In the event that an IP ACL is applied that has not been configured (for example, the name of the applied ACL was configured incorrectly), the system uses an "undefined" ACL mechanism for filtering the packet(s).

This section provides information and instructions for applying ACLs and for configuring an "undefined" ACL.

## Applying the ACL to an Interface

To apply the ACL to an interface, use the following configuration:

```
configure
 context acl_ctxt_name [-noconfirm]
 interface interface_name
 { ip | ipv6 } access-group acl_list_name { in | out } [preference]
 end
```

Notes:

- The context name is the name of the ACL context containing the interface to which the ACL is to be applied.
- The ACL to be applied must be configured in the context specified by this command.
- Up to 16 ACLs can be applied to a group provided that the number of rules configured within the ACL(s) does not exceed the 128-rule limit for the interface.

## Applying an ACL to an Individual Interface

This section provides information and instructions for applying one or more ACLs to an individual interface configured on the system.




---

**Important** This section provides the minimum instruction set for applying the ACL list to an interface on the system. For more information on commands that configure additional parameters and options, refer to the *Ethernet Interface Configuration Mode Commands* chapter in the *Command Line Interface Reference*.

---

To configure the system to provide ACL facility to subscribers:

- 
- Step 1** Apply the configured access control list by following the example configuration in [Applying the ACL to an Interface, on page 283](#)
  - Step 2** Verify that ACL is applied properly on interface by following the steps in [Verifying the ACL Configuration on an Interface, on page 284](#)
  - Step 3** Save your configuration to flash memory, an external memory device, and/or a network location using the Exec mode **save configuration** command. For additional information refer to the *Verifying and Saving Your Configuration* chapter.
- 

## Verifying the ACL Configuration on an Interface

This section describes how to verify the ACL configuration.

In the Exec Mode, enter the following command:

```
[local]host_name# show configuration context context_name
```

*context\_name* is the name of the context containing the interface to which the ACL(s) was/were applied.

The output of this command displays the configuration of the entire context. Examine the output for the commands pertaining to interface configuration. The commands display the ACL(s) applied using this procedure.

```
configure
context context_name
 ip access-list acl_name
 deny host ip_address
 deny ip any host ip_address
 exit
 ip access-group access_group_name
 service-redundancy-protocol
 exit
interface interface_name
 ip address ip_address/mask
 exit
```



```
subscriber default
exit
aaa group default
exit
gtp group default
end
```

---

## Applying the ACL to a Context

To apply the ACLs to a context, use the following configuration:

### configure

```
context acl_ctxt_name [-noconfirm]
 { ip | ipv6 } access-group acl_list_name [in | out] [preference]
end
```

Notes:

- The context name is the name of the ACL context containing the interface to which the ACL is to be applied.
- The context-level ACL is applied to outgoing packets. This applies to incoming packets also if the flow match criteria fails and forwarded again.

The **in** and **out** keywords are deprecated and are only present for backward compatibility.

Context ACL will be applied in the following cases:

- Outgoing packets to an external source.
- Incoming packets that fail flow match and are forwarded again. In this case, the context ACL applies first and only if it passes are packets forwarded.

During forwarding, if an ACL rule is added with a destination address as a loopback address, the context ACL is also applied. This is because StarOS handles packets destined to the kernel by going through a forwarding lookup for them. To apply ACL rules to incoming packets, the interface ACL must be used instead of the context ACL.

- The ACL to be applied must be configured in the context specified by this command.
- Up to 16 ACLs can be applied to a group provided that the number of rules configured within the ACL(s) does not exceed the 256-rule limit for the interface.

## Applying an ACL to All Traffic Within a Context

This section provides information and instructions for applying one or more ACLs to a context configured within a specific context on the system. The applied ACLs, known as policy ACLs, contain rules that apply to all traffic facilitated by the context.



### Important

This section provides the minimum instruction set for applying the ACL list to all traffic within a context. For more information on commands that configure additional parameters and options, refer to the *Context Configuration Mode Commands* chapter in the *Command Line Interface Reference*.

To configure the system to provide access control list facility to subscribers:

- 
- Step 1** Apply the configured ACL as described in [Applying the ACL to a Context, on page 285](#)
  - Step 2** Verify that ACL is applied properly on interface as described in [Verifying the ACL Configuration in a Context, on page 286](#)
  - Step 3** Save your configuration to flash memory, an external memory device, and/or a network location using the Exec mode **save configuration** command. For additional information refer to the *Verifying and Saving Your Configuration* chapter.
- 

## Verifying the ACL Configuration in a Context

To verify the ACL configuration:

Verify that your ACL lists were applied properly by entering the following command in Exec Mode:

```
[local]host_name# show configuration context context_name
```

*context\_name* is the name of the context to which the ACL(s) was/were applied.

The output of this command displays the configuration of the entire context. Examine the output for the commands pertaining to interface configuration. The commands display the ACL(s) applied using this procedure.

```
configure
context context_name
 ip access-list acl_name
 deny host ip_address
 deny ip any host ip_address
 exit
 ip access-group access_group_name
 service-redundancy-protocol
 exit
 interface interface_name
 ip address ip_address/mask
 exit
 subscriber default
 exit
 aaa group default
 exit
 gtpv group default
 end
```

## Applying an ACL to a RADIUS-based Subscriber

IP ACLs are applied to subscribers via attributes in their profile. The subscriber profile could be configured locally on the system or remotely on a RADIUS server.

To apply an ACL to a RADIUS-based subscriber, use the **Filter-Id** attribute.

For more details on this attribute, if you are using StarOS 12.3 or an earlier release, refer to the *AAA and GTPV Interface Administration and Reference*. If you are using StarOS 14.0 or a later release, refer to the *AAA Interface Administration and Reference*.

This section provides information and instructions for applying an ACL to an individual subscriber whose profile is configured locally on the system.



**Important** This section provides the minimum instruction set for applying the ACL list to all traffic within a context. For more information on commands that configure additional parameters and options, refer to the *Subscriber Configuration Mode Commands* chapter in the *Command Line Interface Reference*.

To configure the system to provide access control list facility to subscribers:

- Step 1** Apply the configured access control list by following the example configuration in [Applying an ACL to an Individual Subscriber, on page 287](#)
- Step 2** Verify that ACL is applied properly on interface by following the steps in [Verifying the ACL Configuration to an Individual Subscriber, on page 287](#)
- Step 3** Save your configuration to flash memory, an external memory device, and/or a network location using the Exec mode **save configuration** command. For additional information refer to the *Verifying and Saving Your Configuration* chapter.

## Applying an ACL to an Individual Subscriber

To apply the ACL to an individual subscriber, use the following configuration:

```
configure
context acl_ctxt_name [-noconfirm]
subscriber name subs_name
 { ip | ipv6 } access-group acl_list_name [in | out]
end
```

Notes:

- The context name is the name of the ACL context containing the interface to which the ACL is to be applied.
- If neither the **in** nor the **out** keyword is specified, the ACL will be applied to all inbound and outbound packets.
- The ACL to be applied must be configured in the context specified by this command.
- Up to eight ACLs can be applied to a group provided that the number of rules configured within the ACL(s) does not exceed the 128-rule limit for the interface.

## Verifying the ACL Configuration to an Individual Subscriber

These instructions are used to verify the ACL configuration.

Verify that your ACL lists were applied properly by entering the following command in Exec Mode:

```
[local]host_name# show configuration context context_name
```

*context\_name* is the name of the context containing the subscriber *subs1* to which the ACL(s) was/were applied.

The output of this command displays the configuration of the entire context. Examine the output for the commands pertaining to interface configuration. The commands display the ACL(s) applied using this procedure.

```
configure
 context context_name
 ip access-list acl_name
 deny host ip_address
 deny ip any host ip_address
 exit
 ip access-group access_group_name
 service-redundancy-protocol
 exit
 interface interface
 ip address ip_address/mask
 exit
 subscriber default
 exit
 subscriber name subscriber_name
 ip access-group access_group_name in
 ip access-group access_group_name out
 exit
 aaa group default
 exit
 gtpv group default
 exit
 content-filtering server-group cfsg_name
 response-timeout response_timeout
 connection retry-timeout retry_timeout
 end
```

## Applying an ACL to the Subscriber Named default

This section provides information and instructions for applying an ACL to the subscriber named *default*.



**Important** This section provides the minimum instruction set for applying the ACL list to all traffic within a context. For more information on commands that configure additional parameters and options, refer to *Subscriber Configuration Mode Commands* in the *Command Line Interface Reference*.

To configure the system to provide access control list facility to subscribers:

- Step 1** Apply the configured access control list by following the example configuration in [Applying an ACL to the Subscriber Named default, on page 288](#)
- Step 2** Verify that ACL is applied properly on interface by following the steps in [Verifying the ACL Configuration to the Subscriber Named default, on page 289](#)
- Step 3** Save your configuration to flash memory, an external memory device, and/or a network location using the Exec mode **save configuration** command. For additional information refer to the *Verifying and Saving Your Configuration* chapter.

## Applying an ACL to the Subscriber Named default

To apply the ACL to the subscriber named *default*, use the following configuration:

```

configure
 context acl_ctxt_name [-noconfirm]
 subscriber name subs_name
 { ip | ipv6 } access-group acl_list_name [in | out]
 end

```

Notes:

- The context name is the name of the ACL context containing the interface to which the ACL is to be applied.
- If neither the **in** nor the **out** keyword is specified, the ACL will be applied to all inbound and outbound packets.
- The ACL to be applied must be configured in the context specified by this command.
- Up to 16 ACLs can be applied to a group provided that the number of rules configured within the ACL(s) does not exceed the 256-rule limit for the interface.

## Verifying the ACL Configuration to the Subscriber Named default

These instructions are used to verify the ACL configuration.

---

Verify that your ACL lists were applied properly by entering the following command in Exec Mode:

```
[local]host_name# show configuration context context_name
```

*context\_name* is the name of the context containing the subscriber default to which the ACL(s) was/were applied.

The output of this command displays the configuration of the entire context. Examine the output for the commands pertaining to interface configuration. The commands display the ACL(s) applied using this procedure.

```

configure
 context context_name
 ip access-list acl_name
 deny host ip_address
 deny ip any host ip_address
 exit
 ip access-group access_group_name
 service-redundancy-protocol
 exit
 interface interface
 ip address ip_address/mask
 exit
 subscriber name default
 ip access-group access_group_name in
 ip access-group access_group_name out
 exit
 aaa group default
 exit
 gtp group default
 exit
 content-filtering server-group cfsg_name
 response-timeout response_timeout
 connection retry-timeout retry_timeout
 end

```

---

## Applying an ACL to Service-specified Default Subscriber

This section provides information and instructions for applying an ACL to the subscriber to be used as the "default" profile by various system services.



**Important** This section provides the minimum instruction set for applying the ACL list to all traffic within a context. For more information on commands that configure additional parameters and options, refer to the *Subscriber Configuration Mode Commands* chapter in the *Command Line Interface Reference*.

To configure the system to provide access control list facility to subscribers:

- 
- Step 1** Apply the configured access control list by following the example configuration in [Applying an ACL to the Subscriber Named default, on page 288](#).
- Step 2** Verify that the ACL is applied properly on interface by following the steps in [Verifying the ACL Configuration to Service-specified Default Subscriber, on page 290](#).
- Step 3** Save your configuration to flash memory, an external memory device, and/or a network location using the Exec mode **save configuration** command. For additional information refer to the *Verifying and Saving Your Configuration* chapter.
- 

## Applying an ACL to Service-specified Default Subscriber

To apply the ACL to a service-specified Default subscriber, use the following configuration:

```
configure
 context acl_ctxt_name [-noconfirm]
 { pdsn-service | fa-service | ha-service } service_name
 default subscriber svc_default_subs_name
 exit
 subscriber name svc_default_subs_name
 { ip | ipv6 } access-group acl_list_name [in | out]
 end
```

Notes:

- The context name is the name of the ACL context containing the interface to which the ACL is to be applied.
- If neither the **in** nor the **out** keyword is specified, the ACL will be applied to all inbound and outbound packets.
- The ACL to be applied must be configured in the context specified by this command.
- Up to eight ACLs can be applied to a group provided that the number of rules configured within the ACL(s) does not exceed the 128-rule limit for the interface.

## Verifying the ACL Configuration to Service-specified Default Subscriber

To verify the ACL configuration.

Verify that your ACL lists were applied properly by entering the following command in Exec Mode:

```
[local]host_name# show configuration context context_name
```

*context\_name* is the name of the context containing the service with the default subscriber to which the ACL(s) was/were applied.

The output of this command displays the configuration of the entire context. Examine the output for the commands pertaining to interface configuration. The commands display the ACL(s) applied using this procedure.

```
configure
 context context_name
 ip access-list acl_name
 deny host ip_address
 deny ip any host ip_address
 exit
 ip access-group access_group_name
 interface interface
 ip address ip_address/mask
 exit
 subscriber default
 exit
 subscriber name subscriber_name
 ip access-group access_group_name in
 ip access-group access_group_name out
 exit
 pdsn-service service_name
 default subscriber subscriber_name
 end
```

## Applying a Single ACL to Multiple Subscribers

As mentioned in the previous section, IP ACLs are applied to subscribers via attributes in their profile. The subscriber profile could be configured locally on the system or remotely on a RADIUS server.

The system provides for the configuration of subscriber functions that serve as default values when specific attributes are not contained in the individual subscriber's profile. The following table describes these functions.

**Table 38: Functions Used to Provide "Default" Subscriber Attributes**

Function	Description
Subscriber named <i>default</i>	<p>Within each context, the system creates a subscriber called <i>default</i>. The profile for the subscriber named <i>default</i> provides a configuration template of attribute values for subscribers authenticated in that context.</p> <p>Any subscriber attributes that are not included in a RADIUS-based subscriber profile is configured according to the values for those attributes as defined for the subscriber named <i>default</i>.</p> <p><b>NOTE:</b> The profile for the subscriber named <i>default</i> is <u>not</u> used to provide missing information for subscribers configured locally.</p>

Function	Description
<b>default subscriber</b>	This command allows multiple services to draw "default" subscriber information from multiple profiles.

When configured properly, the functions described in the table above could be used to apply an ACL to:

- All subscribers facilitated within a specific context by applying the ACL to the profile of the subscriber named *default*.
- All subscribers facilitated by specific services by applying the ACL to a subscriber profile and then using the **default subscriber** command to configure the service to use that subscriber as the "default" profile.

## Applying an ACL to Multiple Subscriber via APNs

To apply the ACL to multiple subscribers via APN, use the following configuration:

```
configure
context dest_context_name [-noconfirm]
 apn apn_name
 { ip | ipv6 } access-group acl_list_name [in | out]
 end
```

Notes:

- The ACL to be applied must be in the destination context of the APN (which can be different from the context where the APN is configured).
- If neither the **in** nor the **out** keyword is specified, the ACL will be applied to all inbound and outbound packets.
- This command supports only one ACL. However, the ACL can have up to 256 rules.
- Four access-groups can be applied for each APN, for example:

```
ip access-group acl_list_name_1 in
ip access-group acl_list_name_2 out
ipv6 access-group acl_list_name_3 in
ipv6 access-group acl_list_name_4 out
```

## Applying an ACL to Multiple Subscriber via APNs

If IP ACLs are applied to subscribers via attributes in their profile, the subscriber profile could be configured locally on the system or remotely on a RADIUS server.

To reduce configuration time, ACLs can alternatively be applied to APN templates for GGSN subscribers. When configured, any subscriber packets facilitated by the APN template would then have the associated ACL applied.

This section provides information and instructions for applying an ACL to an APN template.






---

**Important** This section provides the minimum instruction set for applying the ACL list to all traffic within a context. For more information on commands that configure additional parameters and options, refer to the *Subscriber Configuration Mode Commands* chapter in the *Command Line Interface Reference*.

---

To configure the system to provide access control list facility to subscribers:

---

- Step 1** Apply the configured access control list by following the example configuration in [Applying an ACL to Multiple Subscriber via APNs, on page 292](#).
  - Step 2** Verify that ACL is applied properly on interface by following the steps in [Verifying the ACL Configuration to APNs, on page 293](#).
  - Step 3** Save your configuration to flash memory, an external memory device, and/or a network location using the Exec mode **save configuration** command. For additional information refer to the *Verifying and Saving Your Configuration* chapter.
- 

### Verifying the ACL Configuration to APNs

To verify the ACL configuration:

---

Verify that your ACL lists were applied properly by entering the following command in Exec Mode:

```
show configuration context context_name
```

*context\_name* is the name of the context containing the APN *apn1* having *default* subscriber to which the ACL(s) was/were applied.

The output of this command displays the configuration of the entire context. Examine the output for the commands pertaining to interface configuration. The commands display the ACL(s) applied using this procedure.

```
configure
 context context_name
 ip access-list acl_name
 deny host ip_address
 deny ip any host ip_address
 exit
 ip access-group access_group_name
 interface interface
 ip address ip_address/mask
 exit
 subscriber default
 exit
 apn apn_name
 ip access-group access_group_name in
 ip access-group access_group_name out
 end
```

---





## CHAPTER 20

# Congestion Control

---

This chapter describes the Congestion Control feature. It covers the following topics:

- [Overview, on page 295](#)
- [Configuring Congestion Control, on page 296](#)

## Overview

Congestion Control monitors the system for conditions that could potentially degrade performance when the system is under heavy load. Typically, these conditions are temporary (for example, high CPU or memory utilization) and are quickly resolved. However, continuous or large numbers of these conditions within a specific time interval may impact the system's ability to service subscriber sessions. Congestion control helps identify such conditions and invokes policies for addressing the situation.

Congestion control operation is based on configuring the following:

- **Congestion Condition Thresholds:** Thresholds dictate the conditions for which congestion control is enabled and establishes limits for defining the state of the system (congested or clear). These thresholds function in a way similar to operation thresholds that are configured for the system as described in the *Thresholding Configuration Guide*. The primary difference is that when congestion thresholds are reached, a service congestion policy and an SNMP trap (starCongestion) are generated.

A threshold tolerance dictates the percentage under the configured threshold that must be reached in order for the condition to be cleared. An SNMP trap, starCongestionClear, is then triggered.

- **Port Utilization Thresholds:** If you set a port utilization threshold, when the average utilization of all ports in the system reaches the specified threshold, congestion control is enabled.
- **Port-specific Thresholds:** If you set port-specific thresholds, when any individual port-specific threshold is reached, congestion control is enabled system-wide.
- **Service Congestion Policies:** Congestion policies are configurable for each service. These policies dictate how services respond when the system detects that a congestion condition threshold has been crossed.

**Important**

This section provides the minimum instruction set for configuring congestion control. Commands that configure additional interface or port properties are provided in *Subscriber Configuration Mode* in the *Command Line Interface Reference*. Always refer to the Administration Guides for all of the licensed products running on this platform for additional configuration information with respect to congestion control. Congestion control functionality varies based on product and StarOS version.

For the MME three levels of congestion control thresholds are supported – critical, major and minor. By default only the critical threshold is supported for other products. SNMP traps also support major and minor congestion control thresholds. A set of **congestion-action-profile** commands allows an operator to establish additional actions to be taken for specific thresholds and threshold levels.

## Configuring Congestion Control

To configure Congestion Control functionality:

- 
- Step 1** Configure congestion control thresholds as described in [Configuring the Congestion Control Threshold, on page 296](#)
  - Step 2** Configure service congestion policies as described in [Configuring Service Congestion Policies, on page 297](#)
  - Step 3** Enable redirect overload policies as described in [Enabling Congestion Control Redirect Overload Policy, on page 298](#)
  - Step 4** Configure disconnecting subscribers based on call or inactivity time as described in [Disconnecting Subscribers Based on Call or Inactivity Time, on page 298](#)
  - Step 5** Save your configuration as described in the *Verifying and Saving Your Configuration* chapter.
- 

## Configuring the Congestion Control Threshold

To configure congestion control threshold, apply the following example configuration in the Global Configuration mode of the CLI:

```
configure
 congestion-control threshold max-sessions-per-service-utilization percent
 congestion-control threshold tolerance percent
end
```

Notes:

- There are numerous threshold parameters. See *Global Configuration Mode Commands* in the *Command Line Interface Reference* for more information.
- The tolerance is the percentage under a configured threshold that dictates the point at which the condition is cleared.
- Multiple levels of congestion thresholds – critical, major and minor – are supported for various types of congestion control thresholds. If a threshold level is not specified, the default is critical. Currently, major and minor thresholds are only supported for the MME. The **congestion-action-profile** command under **lte-policy** defines the action to be taken when thresholds are exceeded. See *Global Configuration*

*Mode Commands, LTE Policy Configuration Mode Commands and Congestion Action Profile Configuration Mode Commands in the Command Line Interface Reference for more information.*

- Repeat this configuration as needed for additional thresholds.

## Configuring Service Congestion Policies

To create a congestion control policy, apply the following example configuration in the Global Configuration mode of the CLI:

```
configure
 congestion-control policy service action { drop | none | redirect |
reject }
 end
```

Notes:

- When the redirect action occurs for PDSN services, the PDSN responds to the PCF with a reply code of 136, "unknown PDSN address" along with the IP address of an alternate PDSN.
- **redirect** is not available for PDIF. The default action for PDIF is "none."
- When the redirect action occurs for HA services, the system responds to the FA with a reply code of 136, "unknown home agent address".
- **redirect** cannot be used in conjunction with GGSN services.
- **redirect** is not available for the Local Mobility Anchor (LMA) service.
- When setting the action to **reject**, the reply code is 130, "insufficient resources".
- For the GGSN, the reply code is 199, "no resources available".
- For the SaMOG, MME, **redirect** is not available.
- For the MME, create action profiles for optional major and minor thresholds using the **congestion-action-profile** command under **lte-policy** in the Global Configuration mode.
- For the MME, you can specify *service* as **critical**, **major** or **minor** to set a policy and associate an action-profile for the respective threshold. See *Global Configuration Mode Commands* in the *Command Line Interface Reference* for more information.

## Configuring Overload Reporting on the MME

When an overload condition is detected on an MME and the report-overload keyword is enabled in the **congestion-control policy** command, the system reports the condition to a specified percentage of eNodeBs and proceeds to take the configured action on incoming sessions. To create a congestion control policy with overload reporting, apply the following example configuration:

```
configure
 congestion-control policy mme-service action report-overload
reject-new-sessions enodeb-percentage percentage
 end
```

Notes:

- Other overload actions include **permit-emergency-sessions** and **reject-non-emergency-sessions**.

## Enabling Congestion Control Redirect Overload Policy

To create a congestion control policy and configure a redirect overload policy for the service, apply the following example configuration:

```
configure
 congestion-control
 context context_name
 {service_configuration_mode}
 policy overload redirect address
 end
```

Notes:

- *Optional:* If the congestion control policy action was configured to **redirect**, then a redirect overload policy must be configured for the service(s) that are affected.
- There are several service configuration modes that you can configure. See the *Command Line Interface Reference* for a complete list of modes.
- You can set various options for redirection. See the *Command Line Interface Reference* for more information.
- Repeat this configuration example to configure overload policies for additional services configured in the same context.

## Verify the Service Overload Policies

To verify that the service overload policies were properly configured enter the following command in the Exec Mode:

```
[local]host_name# show service_type name service_name
```

This command lists the entire service configuration. Verify that the information displayed for the "Overload Policy" is accurate.

Repeat this configuration example to configure additional services in other contexts.

## Verify the Congestion Control Configuration

### Verify MME Congestion Action Profiles

To verify MME multilevel congestion action profiles, run the following Exec mode command:

```
[local]host_name# show lte-policy congestion-action-profile { name profile_name
| summary }
```

## Disconnecting Subscribers Based on Call or Inactivity Time

During periods of heavy system load, it may be necessary to disconnect subscribers in order to maintain an acceptable level of system performance. You can establish thresholds to select subscribers to disconnect based on the length of time that a call has been connected or inactive.

To enable overload disconnect for the currently selected subscriber, use the following configuration example:

```
configure
 context context_name
 subscriber name subscriber_name
 default overload-disconnect threshold inactivity-time dur_thresh
 default overload-disconnect threshold connect-time dur_thresh
 end
```

To disable the overload disconnect feature for this subscriber, use the following configuration example:

```
configure
 context context_name
 subscriber subscriber_name
 no overload-disconnect { [threshold inactivity-time] | [threshold
connect-time] }
 end
```







# CHAPTER 21

## Routing

---

This chapter provides information on configuring an enhanced, or extended, service. The product administration guides provide examples and procedures for configuring basic services on the system. You should select the configuration example that best meets your service model, and configure the required elements for that model before using the procedures described below.

This chapter includes the following sections:

- [Routing Policies, on page 301](#)
- [Static Routing, on page 303](#)
- [OSPF Routing, on page 304](#)
- [OSPFv3 Routing, on page 307](#)
- [Equal Cost Multiple Path \(ECMP\), on page 308](#)
- [BGP-4 Routing, on page 308](#)
- [Bidirectional Forwarding Detection, on page 318](#)
- [Viewing Routing Information, on page 327](#)

## Routing Policies

This section describes how to configure the elements needed to define routing policies. Routing policies modify and redirect routes to and from the system to satisfy specific network deployment requirements.

Use the following building blocks to configure routing policies:

- **Route Access Lists** – The basic building block of a routing policy. Route access lists filter routes based on a range of IP addresses.
- **IP Prefix Lists** – A more advanced element of a routing policy. An IP Prefix list filters routes based on IP prefixes.
- **AS Path Access Lists** – A basic building block used for Border Gateway Protocol (BGP) routing. These lists filter Autonomous System (AS) paths.
- **Route Maps** – Route-maps provide detailed control over routes during route selection or route advertisement by a routing protocol, and in route redistribution between routing protocols. For this level of control you use IP Prefix Lists, Route Access Lists and AS Path Access Lists to specify IP addresses, address ranges, and Autonomous System paths.

## Creating IP Prefix Lists

Use the following configuration example to create IP Prefix Lists:

```
config
 context context_name
 ip prefix-list name list_name { deny | permit } network_address/net_mask
```

Notes:

- Set the IP prefix list to deny, permit or match any prefix.
- IPv4 dotted-decimal and IPv6 colon-separated-hexadecimal addresses are supported.
- Save your configuration as described in the *Verifying and Saving Your Configuration* chapter.

## Creating Route Access Lists

Use the following procedure to create a Route Access List:

```
config
 context context_name
 route-access-list { extended identifier } { deny | permit } [ip
address ip_address]
 route-access-list named list_name { deny | permit } { ip_address/mask |
any } [exact-match]
 route-access-list
 standard identifier { permit | deny } { ip_address
wildcard_mask | any | network_address }
```

Notes:

- A maximum of 64 access lists are supported per context.
- A maximum of 16 entries can be defined for each route-access-list.
- Save your configuration as described in the *Verifying and Saving Your Configuration* chapter.

## Creating AS Path Access Lists

Use the following procedure to create an AS Path Access List:

```
config
 context context_name
 ip as-path access-list list_name [{ deny | permit } reg_expr]
```

Notes:

- Save your configuration as described in the *Verifying and Saving Your Configuration* chapter.

## Creating Route Maps

Use the following configuration example to create a Route Map:

```

config
 context context_name
 route-map map_name { deny | permit } seq_number

```

Notes:

- Use the **match** and **set** commands in Route Map Configuration mode to configure the route map. Refer to the *Command Line Interface Reference* for more information on these commands.
- Save your configuration as described in the *Verifying and Saving Your Configuration* chapter.

## Sample Configuration

The example below shows a configuration that creates two route access lists, applies them to a route map, and uses that route map for a BGP router neighbor.

The example below shows a configuration that creates two route access lists, applies them to a route map, and uses that route map for a BGP router neighbor.

```

config
 context ispl
 route-access-list named RACLin1a permit 88.151.1.0/30
 route-access-list named RACLin1a permit 88.151.1.4/30
 route-access-list named RACLany permit any
 route-map RMnet1 deny 100
 match ip address route-access-list RACLin 1 a
 #exit
 route-map RMnet1 deny 200
 match ip address route-access-list RACLin 1 b
 #exit
 route-map RMnet1 permit 1000
 match ip address route-access-list RACLany
 #exit
 router bgp 1
 neighbor 152.20.1.99 as-path 101
 neighbor 152.20.1.99 route-map RMnet1

```

## Static Routing

The system supports static network route configuration on a per context basis. Define network routes by specifying the:

- IP address and mask for the route
- Name of the interface in the current context that the route must use
- Next hop IP address



### Important

On the ASR 5500, static routes with IPv6 prefix lengths less than /12 and between the range of /64 and /128 are not supported.

## Adding Static Routes to a Context

To add static routes to a context configuration, you must know the names of the interfaces that are configured in the current context. Use the **show ip interface** command to list the interfaces in the current context (Exec mode).

Information for all interfaces configured in the current context is displayed as shown in the following example.

```
[local]host_name# show ip interface
Intf Name: Egress 1
Description:
IP State: Up (Bound to slot/port untagged ifIndex 402718721)
IP Address: 192.168.231.5
Subnet Mask: 255.255.255.0
Bcast Address: 192.168.231.255
MTU: 1500
Resoln Type: ARP ARP timeout: 3600 secs
L3 monitor LC-port switchover: Disabled
Number of Secondary Addresses: 0
Total interface count: 1
```

The first line of information for each interface lists the interface name for the current context as shown in the example output. In this example, there is one interface with the name *Egress 1*.

```
config
 context context_name
 ip route { ip_address [ip_mask] | ip_addr_mask_combo } { next-hop
next_hop_address | egress_name [precedence precedence [cost cost]
```

Notes:

- You can configure a maximum of 1,200 static routes per context. Save your configuration as described in the *Verifying and Saving Your Configuration* chapter.

## Deleting Static Routes From a Context

Use the following configuration example to remove static routes from a context's configuration:

```
config
 context context_name
 no ip route { ip_address ip_mask | ip_addr_mask_combo } next_hop_address
egress_name [precedence precedence] [cost cost]
```

Notes

- Save your configuration as described in the *Verifying and Saving Your Configuration* chapter.

## OSPF Routing

This section gives an overview of Open Shortest Path First (OSPF) routing and its implementation in the system. It also describes how to enable the base OSPF functionality and lists the commands that are available for more complex configurations.

You must purchase and install a license key before you can use this feature. Contact your Cisco account representative for more information on licenses.

**Important**

During system task recovery, it is possible for a dynamically-learned forwarding entry to incorrectly remain in the system forwarding table if that forwarding entry has been removed from the dynamic routing protocol during the recovery.

**Important**

On the ASR 5500, OSPF routes with IPv6 prefix lengths less than /12 and between the range of /64 and /128 are not supported.

## OSPF Version 2 Overview

OSPF is a link-state routing protocol that employs an interior gateway protocol (IGP) to route IP packets using the shortest path first based solely on the destination IP address in the IP packet header. OSPF routed IP packets are not encapsulated in any additional protocol headers as they transit the network.

An Autonomous System (AS), or Domain, is defined as a group of networks within a common routing infrastructure.

OSPF is a dynamic routing protocol that quickly detects topological changes in the AS (such as router interface failures) and calculates new loop-free routes after a period of convergence. This period of convergence is short and involves a minimum of routing traffic.

In a link-state routing protocol, each router maintains a database, referred to as the link-state database, that describes the Autonomous System's topology. Each participating router has an identical database. Each entry in this database is a particular router's local state (for example, the router's usable interfaces and reachable neighbors). The router distributes its local state throughout the AS by flooding.

All routers run the same algorithm in parallel. From the link-state database, each router constructs a tree of shortest paths with itself as root to each destination in the AS. Externally derived routing information appears on the tree as leaves. The cost of a route is described by a single dimensionless metric.

OSPF allows sets of networks to be grouped together. Such a grouping is called an area. The topology of this area is hidden from the rest of the AS, which enables a significant reduction in routing traffic. Also, routing within the area is determined only by the area's own topology, lending the area protection from bad routing data. An area is a generalization of an IP subnetted network.

OSPF enables the flexible configuration of IP subnets so that each route distributed by OSPF has a destination and mask. Two different subnets of the same IP network number may have different sizes (that is, different masks). This is commonly referred to as variable-length subnetting. A packet is routed to the best (longest or most specific) match. Host routes are considered to be subnets whose masks are "all ones" (0xffffffff).

OSPF traffic can be authenticated or non-authenticated, or can use no authentication, simple/clear text passwords, or MD5-based passwords. This means that only trusted routers can participate in the AS routing. You can specify a variety of authentication schemes and, in fact, you can configure separate authentication schemes for each IP subnet.

Externally derived routing data (for example, routes learned from an exterior protocol such as BGP) is advertised throughout the AS. This externally derived data is kept separate from the OSPF link state data.

Each external route can also be tagged by the advertising router, enabling the passing of additional information between routers on the boundary of the AS.

OSPF uses a link-state algorithm to build and calculate the shortest path to all known destinations.

## Basic OSPFv2 Configuration

This section describes how to implement basic OSPF routing.

### Enabling OSPF Routing For a Specific Context

Use the following configuration example to enable OSPF Routing for a specific context:

```
config
 context context_name
 router ospf
 end
```

Notes:

- Save your configuration as described in the *Verifying and Saving Your Configuration* chapter.

### Enabling OSPF Over a Specific Interface

After you enable OSPF, specify the networks on which it will run. Use the following command to enable OSPF:

```
network network_ip_address/network_mask area { area_id | area_ip_address }
```



#### Important

The default cost for OSPF on the system is 10. To change the cost, refer to the **ip ospf cost** command in the *Ethernet Interface Configuration Mode Commands* chapter of the *Command Line Interface Reference*.

Notes:

- Save your configuration as described in the *Verifying and Saving Your Configuration* chapter.

### Redistributing Routes Into OSPF (Optional)

Redistributing routes into OSPF means any routes from another protocol that meet specified a specified criterion, such as route type, metric, or rule within a route-map, are redistributed using the OSPFv2 protocol to all OSPF areas. This is an optional configuration.

```
config
 context context_name
 router ospf
 redistribute { connected | static }
 end
```

Notes:

- Save your configuration as described in the *Verifying and Saving Your Configuration* chapter.

### Confirming OSPF Configuration Parameters

To confirm the OSPF router configuration, use the following command and look for the section labeled **router ospf** in the screen output:

```
show config context ctxt_name [verbose]
```

# OSPFv3 Routing

This section gives an overview of Open Shortest Path First Version 3 (OSPFv3) routing and its implementation in the system. It also describes how to enable the base OSPFv3 functionality and lists the commands that are available for more complex configurations.

**Important**

On the ASR 5500, OSPFv3 routes with IPv6 prefix lengths less than /12 and between the range of /64 and /128 are not supported.

## OSPFv3 Overview

Much of OSPF version 3 is the same as OSPF version 2. OSPFv3 expands on OSPF version 2 to provide support for IPv6 routing prefixes and the larger size of IPv6 addresses. OSPFv3 dynamically learns and advertises (redistributes) IPv6 routes within an OSPFv3 routing domain.

In OSPFv3, a routing process does not need to be explicitly created. Enabling OSPFv3 on an interface will cause a routing process and its associated configuration to be created.

## Basic OSPFv3 Configuration

This section describes how to implement basic OSPF routing.

### Enabling OSPFv3 Routing For a Specific Context

Use the following configuration example to enable OSPF Routing for a specific context:

```
config
 context context_name
 router ospfv3
 end
```

Notes:

- Save your configuration as described in the *Verifying and Saving Your Configuration* chapter.

### Enabling OSPFv3 Over a Specific Interface

After you enable OSPFv3 specify the area in which it will run. Use the following command to enable OSPFv3:

```
area { area_id | area_ip_address } [default-cost dflt-cost] [stub stub-area]
[virtual-link vl-neighbor-ipv4address]
```

**Important**

The default cost for OSPFv3 on the system is 10. To change the cost, refer to the **ipv6 ospf cost** command in the *Ethernet Interface Configuration Mode Commands* chapter of the *Command Line Interface Reference*.

Notes:

- Save your configuration as described in the *Verifying and Saving Your Configuration* chapter.

## Redistributing Routes Into OSPFv3 (Optional)

Redistributing routes into OSPFv3 means any routes from another protocol that meet specified a specified criterion, such as route type, metric, or rule within a route-map, are redistributed using the OSPFv3 protocol to all OSPF areas. This is an optional configuration.

```
config
 context context_name
 router ospf3
 redistribute { connected | static }
 end
```

Notes:

- Save your configuration as described in the *Verifying and Saving Your Configuration* chapter.

## Confirming OSPFv3 Configuration Parameters

To confirm the OSPF router configuration, use the following command and look for the section labeled **router ipv6 ospf** in the screen output:

```
show config context ctxt_name [verbose]
```

## Equal Cost Multiple Path (ECMP)

The system supports ECMP for routing protocols. ECMP distributes traffic across multiple routes that have the same cost to lessen the burden on any one route.

ECMP can be used in conjunction with most routing protocols, since it is a per-hop decision that is limited to a single router. It potentially offers substantial increases in bandwidth by load-balancing traffic over multiple paths

The following command configures the maximum number of equal cost paths that can be submitted by a routing protocol:

```
config
 context context_name
 ip routing maximum-paths [max_num]
```

Notes:

- *max\_num* is an integer from 1 through 10 (*releases prior to 18.2*) or 1 through 32 (*release 18.2+*).
- Save your configuration as described in the *Verifying and Saving Your Configuration* chapter.

## BGP-4 Routing

The Border Gateway Protocol 4 (BGP-4) routing protocol is supported through a BGP router process that is implemented at the context level.



Border Gateway Protocol (BGP) is an inter-AS routing protocol. An Autonomous System (AS) is a set of routers under a single technical administration that use an interior gateway protocol and common metrics to route packets within the AS. The set of routers uses an exterior gateway protocol to route packets to other autonomous systems.

BGP runs over TCP. This eliminates the need for the BGP protocol to implement explicit update fragmentation, retransmission, acknowledgement, and sequencing information. Any authentication scheme used by TCP may be used in addition to BGP's own authentication mechanisms.

BGP routers exchange network reachability information with other BGP routers. This information builds a picture of AS connectivity from which routes are filtered and AS-level policy decisions are enforced.

BGP-4 provides classless inter-domain routing. This includes support for advertising an IP prefix and eliminates the concept of network class within BGP. BGP-4 also allows the aggregation of routes, including the aggregation of AS paths.

**Important**

On the ASR 5500, BGP routes with IPv6 prefix lengths less than /12 and between the range of /64 and /128 are not supported.

## Overview of BGP Support

Mobile devices communicate to the Internet through Home Agents (HAs). HAs assign IP addresses to the mobile node from a configured pool of addresses. These addresses are also advertised to Internet routers through an IP routing protocol to ensure dynamic routing. The BGP-4 protocol is used as a monitoring mechanism between an HA and Internet router with routing to support Interchassis Session Recovery (ICSR). (Refer to *Interchassis Session Recovery* for more information.)

The objective of BGP-4 protocol support is to satisfy routing requirements and monitor communications with Internet routers. BGP-4 may trigger an active to standby switchover to keep subscriber services from being interrupted.

The following BGP-4 features are supported:

- Exterior Border Gateway Protocol (EBGP) multi-hop
- Route Filtering for inbound and outbound routes
- Route redistribution and route-maps
- Support for BGP communities and extended communities in route maps
- Local preference for IPv4 and IPv6 (IBGP peers)

IP pool routes and loopback routes are advertised in the BGP domain in the following ways:

- Through BGP Configuration Mode **redistribution** commands, all or some of the connected routes are redistributed into the BGP domain. (IP pool and loopback routes are present in the IP routing table as connected routes.) The **network routemap** command provides the flexibility to change many BGP attributes.
- Through the BGP Configuration Mode **network** commands, connected routes are explicitly configured for advertisement into the BGP domain. The **network routemap** command provides the flexibility to change many BGP attributes. Refer to the *BGP Configuration Mode Commands* chapter of the *Command Line Interface Reference* for details on these commands.




---

**Important** If a BGP task restarts because of a processing card failure, a migration, a crash, or the removal of a processing card, all peering session and route information is lost.

---

## Configuring BGP

This section describes how to configure and enable basic BGP routing support in the system.

```
config
 context context_name
 router bgp AS_number
 neighbor ip_address remote-as AS_num
```

Notes:

- A maximum of 64 BGP peers are supported per context.
- Save your configuration as described in the *Verifying and Saving Your Configuration* chapter.

## Redistributing Routes Into BGP (Optional)

Redistributing routes into BGP simply means that any routes from another protocol that meet a specified criterion, such as a route type, or a rule within a route-map, are redistributed through the BGP protocol to all BGP areas. This is an optional configuration.

```
config
 context context_name
 router bgp as_number
 redistribute bgp { bgp | connected | static } [metric metric_value
] [metric-type { 1 | 2 }] [route-map route_map_name]
```

Notes:

- The redistribution options are connected, ospf, rip, or static. Refer to the *Border Gateway Protocol Configuration Mode Commands* chapter of the *Command Line Interface Reference* for details on the **redistribute** command.
- A maximum of 64 route-maps are supported per context.
- Save your configuration as described in the *Verifying and Saving Your Configuration* chapter.

## BGP Communities and Extended Communities

Route filtering based on a BGP community or extended community (route target) is configured via CLI Route Map Configuration mode commands.

## BGP Communities

### Configuring a BGP Community

A BGP community is a group of destinations that share some common attribute. Each destination can belong to multiple communities. Autonomous system administrators define to which communities a destination belongs.

You configure a BGP community via a Context Configuration mode command.

```

config
 context context_name
 ip community-list { named named_list | standard identifier } { deny |
permit } { internet | local-AS | no-advertise | no-export | value
AS-community_number AS-community_number AS-community_number ... }
 { internet | local-AS | no-advertise | no-export | value
AS-community_number AS-community_number AS-community_number ... }
 { internet | local-AS | no-advertise | no-export | value
AS-community_number AS-community_number AS-community_number ... }

```

You can permit or deny the following BGP community destinations.

- **internet** – Advertise this route to the internet community, and any router that belongs to it.
- **local-AS** – Use in confederation scenarios to prevent sending packets outside the local autonomous system (AS).
- **no-advertise** – Do not advertise this route to any BGP peer, internal or external.
- **no-export** – Do not advertise to external BGP (eBGP) peers. Keep this route within an AS.
- **value** *AS-community\_number* – Specifies a community string in AS:NN format, where AS = 2-byte AS-community hexadecimal number and NN = 2-byte hexadecimal number (1 to 11 characters).

You can enter multiple destinations and AS community numbers for each community. For additional information, see the *Command Line Interface Reference*.

Multiple community-list entries can be attached to a community-list by adding multiple permit or deny clauses for various community strings. Up to 64 community-lists can be configured in a context.

### Setting the Community Attribute

You set the BGP community attribute via a **set community** command in a route map.

```

config
 context context_name
 route-map map_name { deny | permit } sequence_number
 set community [additive]{ internet | local-AS | no-advertise |
no-export | none | value AS-community_number AS-community_number AS-community_number
... }
 { internet | local-AS | no-advertise | no-export | none | value
AS-community_number AS-community_number AS-community_number ... }
 { internet | local-AS | no-advertise | no-export | none | value
AS-community_number AS-community_number AS-community_number ... }

```

The **additive** option allows you to enter multiple destinations and AS community numbers. For additional information, see the *Command Line Interface Reference*.

## Filtering via a BGP Community

To filter routes based on a BGP community, you configure a **match** clause in a route map. The command sequence follows below.

```
config
 context context_name
 route-map map_name { deny | permit } sequence_number
 match community { named named_list | standard identifier }
```

## BGP Extended Communities

### Configuring a BGP Extended Community (Route Target)

A BGP extended community defines a route target. MPLS VPNs use a 64-bit Extended Community attribute called a Route Target (RT). An RT enables distribution of reachability information to the correct information table.

You configure a BGP extended community via a Context Configuration mode command.

```
config
 context context_name
 ip extcommunity-list { named named_list | standard identifier } { deny
 | permit } rt rt_number rt_number rt_number ...
```

*rt\_number* specifies a Route Target as a string in AS:NN format, where AS = 2-byte AS-community hexadecimal number and NN = 2-byte hexadecimal number (1 to 11 characters). You can add multiple route numbers to an IP extcommunity list.

Multiple extended community-list entries can be attached to an extended community-list by adding multiple permit or deny clauses for various extended community strings. Up to 64 extended community-lists can be configured in a context.

### Setting the Extended Community Attribute

You set the BGP extended community attribute via a **set extcommunity** command in a route map.

```
config
 context context_name
 route-map map_name { deny | permit } sequence_number
 set extcommunity rt rt_number rt_number rt_number ...
```

*rt\_number* specifies a Route Target as a string in AS:NN format, where AS = 2-byte AS-community hexadecimal number and NN = 2-byte hexadecimal number (1 to 11 characters). You can add multiple route numbers to an IP extcommunity list.

### Filtering via a BGP Extended Community

To filter routes based on a BGP extended community (route target), you configure a **match** clause in a route map. The command sequence follows below.

```
config
 context context_name
 route-map map_name { deny | permit }
 [no] match extcommunity { named named_list | standard identifier }
```

## BGP Local Preference

The BGP local preference attribute is sent by a BGP speaker only to IBGP peers. It is set in a route map via the following command sequence:

```
config
 context context_name
 route-map map_name { deny | permit }
 set local-preference pref_number
```

There is no **match** clause corresponding to local preference in the route-map because local-preference is directly used in the route selection algorithm.

## ICSR and SRP Groups

BGP is employed with Interchassis Session Recovery (ICSR) configurations linked via Service Redundancy Protocol (SRP). By default an ICSR failover is triggered when all BGP peers within a context are down.

Optionally, you can configure SRP peer groups within a context. ICSR failover would then occur if all peers within a group fail. This option is useful in deployments in which a combination of IPv4 and IPv6 peers are spread across multiple paired VLANs, and IPv4 or IPv6 connectivity is lost by all members of a peer group.

For additional information refer to *Interchassis Session Recovery* in this guide and the description of the **monitor bgp**, **monitor diameter** and **monitor authentication-probe** commands in the *Service Redundancy Protocol Configuration Mode Commands* chapter of the *Command Line Interface Reference*.

## Advertising BGP Routes from a Standby ICSR Chassis

An SRP Configuration mode command enables advertising BGP routes from an ICSR chassis in standby state. This command and its keywords allow an operator to take advantage of faster network convergence accrued from deploying BGP Prefix Independent Convergence (PIC) in the Optical Transport Network Generation Next (OTNGN).

BGP PIC is intended to improve network convergence which will safely allow for setting aggressive ICSR failure detection timers.

```
configure
 context context_name
 service-redundancy-protocol
 advertise-routes-in-standby-state [hold-off-time hold-off-time] [
reset-bfd-nbrs bfd-down-time]
 end
```

Notes:

- **hold-off-time** *hold-off-time* delays advertising the BGP routes until the timer expires. Specify *hold-off-time* in seconds as an integer from 1 to 300.
- After resetting BFD, **reset-bfd-nbrs** *bfd-down-time* keeps the BFD sessions down for the configured number of milliseconds to improve network convergence. Specify *bfd-down-time* as an integer from 50 to 120000.

## Configurable BGP Route Advertisement Interval for ICSR

By default, the MinRtAdvInterval is set for each peer with a value of 5 seconds for an iBGP peer and 30 seconds for an eBGP peer. An operator can use the **neighbor identifier advertisement-interval** command to globally change the default interval.

The BGP advertisement-interval can also be separately set for each address family. If configured, this value over-rides the peer's default advertisement-interval for that address-family only. BGP will send route update-message for each AFI/SAFI based on the advertisement-interval configured for that AFI/SAFI. If no AFI/SAFI advertisement-interval is configured, the peer-based default advertisement-interval is used.

In ICSR configurations, this feature can be used to speed route advertisements and improve network convergence times.

The **timers bgp icshr-aggr-advertisement-interval** command is available in both the BGP Address-Family (VPNv4/VPNv6) Configuration and BGP Address-Family (VRF) Configuration modes.

```
configure
 context context_name
 router bgp as_number
 address-family { ipv4 | ipv6 | vpnv4 | vpnv6 }
 timers bgp icshr-aggr-advertisement-interval seconds
```

Notes:

- *seconds* – sets the number of seconds as an integer from 0 to 30. Default: 0.

## BGP CLI Configuration Commands

The following table lists the BGP Configuration mode CLI commands that support the configuration of various BGP parameters. For additional information, refer to the *BGP Configuration Mode Commands* chapter of the *Command Line Interface Reference*

```
configure
 context context_name
 router bgp as_number
```

**Table 39: BGP Configuration Mode CLI Commands**

bgp Command	Description
<b>accept-zero-as-rd</b>	Configures to accept VPN prefixes with Route Distinguisher (RD) value having Administrator Subfield, which is an AS number 0.
<b>address-family { ipv4   ipv6 }</b>	Enters the IPv4 or IPv6 Address Family configuration mode.
<b>address-family { vpnv4   vpnv6 }</b>	Enters the VPNv4 or VPNv6 Address Family configuration mode.
<b>bgp graceful-restart { restart-time rest_time   stalepath-time stale_time   update-delay delay</b>	Defines the BGP-specific parameters regarding graceful restarts.

<b>bgp Command</b>	<b>Description</b>
<b>description</b> <i>text</i>	Allows you to enter descriptive text for this configuration.
<b>distance</b> { <b>admin</b> <i>distance</i> <b>prefix</b> <i>prefix_addr</i> [ <b>route-access-list</b> <i>list_name</i> ]   <b>bgp external</b> <i>ebgp_dist</i> <b>internal</b> <i>ibgp_dist</i> local <i>local_dist</i> }	Defines the administrative distance for routes. The administrative distance is the default priority for a specific route or type route.
<b>enforce-first-as</b>	Enforces the first AS for Exterior Border Gateway Protocol (eBGP) routes.
<b>ip vrf</b> <i>vrf_name</i>	Adds a preconfigured IP VRF context instance to the BGP ASN and configures the BGP attributes and related parameters to the VRF.
<b>maximum-paths</b> { <b>ebgp</b> <i>max_num</i>   <b>ibgp</b> <i>max_num</i> }	Enables forwarding packets over multiple paths and specifies the maximum number of external BGP (eBGP) or internal BGP (iBGP) paths between neighbors.
<b>neighbor</b> <i>ip_address</i> { <b>activate</b>   <b>advertisement-interval</b> <i>adv_time</i>   <b>capability graceful-restart</b>   <b>default-originate</b> [ <b>route-map</b> <i>map_name</i> ]   <b>distribute-list</b> <i>dist_list</i> { <b>in</b>   <b>out</b> }   <b>ebgp-multihop</b> [ <b>max-hop</b> <i>number</i> ]   <b>encrypted password</b> <i>encrypted_password</i>   <b>fall-over bfd</b>   <b>multihop</b> ]   <b>filter-list</b> <i>filt_list</i> { <b>in</b>   <b>out</b> }   <b>max-prefix</b> <i>max_num</i> [ <b>threshold</b> <i>thresh_percent</i> ] [ <b>warning-only</b> ]   <b>next-hop-self</b>   <b>password</b> <i>password</i>   <b>remoteas</b> <i>AS_num</i>   <b>remove-private-AS</b>   <b>restart-time</b> <i>rest_time</i>   <b>route-map</b> <i>map_name</i> { <b>in</b>   <b>out</b> }   <b>send-community</b> { <b>both</b>   <b>extended</b>   <b>standard</b> }   <b>shutdown</b>   <b>srp-activated-soft-clear</b>   <b>timers</b> { [ <b>connect-interval</b> <i>conn_time</i> ]   [ <b>keepalive-interval</b> <i>keep_time</i> <b>holdtimeinterval</b> <i>hold_time</i> ] }   <b>update-source</b> <i>ip_address</i>   <b>weight value</b> }	Configures BGP routers that interconnect to non-broadcast networks. Note that a remote AS number must be specified for a neighbor before other parameters can be configured.  <b>Note:</b> The <b>advertisement-interval</b> must be explicitly configured for an address-family so that it can take effect for that address-family. By default it will be applicable only for the IPv4 address-family. Specify the address family via the <b>address-family</b> command. You can then set the neighbor advertisement-interval in the address family configuration mode.
<b>network</b> <i>ip_address/mask</i> [ <b>route-map</b> <i>map_name</i> ]	Specifies a network to announce via BGP.
<b>redistribute</b> { <b>connected</b>   <b>ospf</b>   <b>rip</b>   <b>static</b> } [ <b>route-map</b> <i>map_name</i> ]	Redistributes routes via BGP from another protocol to BGP neighbors.
<b>router-id</b> <i>ip_address</i>	Overrides the configured router identifier and causes BGP peers to reset.
<b>scan-time</b> <i>time</i>	Configures the BGP background scanner interval in seconds. BGP monitors the next hop of the installed routes to verify next-hop reachability and to select, install, and validate the BGP best path. loops.
<b>timers</b> <b>bgp</b> <b>keepalive-interval</b> <i>interval</i> <b>holdtime-interval</b> <i>time</i> [ <b>min-peer-holdtimeinterval</b> <i>time</i> ]	Configures BGP routing timers.

## Confirming BGP Configuration Parameters

To confirm the BGP router configuration, use the following command and look for the section labeled **router bgp** in the screen output:

```
show config context ctxt_name [verbose]
```

## BGP Peer Limit

### Feature Summary and Revision History

#### Summary Data

Applicable Product(s) or Functional Area	All
Applicable Platform(s)	VPC - DI
Feature Default	Disabled - Configuration Required
Related Changes in This Release	Not Applicable
Related Documentation	<ul style="list-style-type: none"> <li>• <i>Command Line Interface Reference</i></li> <li>• <i>Statistics and Counters Reference</i></li> <li>• <i>VPC-DI System Administration Guide</i></li> </ul>

#### Revision History

Revision Details	Release
First introduced.	21.8

### Feature Description

In the architecture, the flexibility of BGP peering is provided across packet processing cards namely, Session Function (SF) cards, including the demux SF cards.

In deployment setups based on “contrail” model of the SDN , each packet processing card has a vRouter within the compute node. In this model, with the current flexible BGP peering scheme, the BGP configurations needs to be implemented on each of those vRouters. This poses a challenge to service providers when there are large number of SF cards in their network. The number of lines of configuration required, poses a scaling challenge.

To overcome this challenge, the BGP Peer Limit feature is introduced that restricts BGP peering to only **two** SF cards in the VPC-DI architecture. This feature mandates that the routing table has only two routes corresponding to the two SF cards, with a third route being a “blackhole” or a “null” route. To ensure that the new routes are longest-prefix-match routes, provisioning of only host-addresses only (/32 bitmask) is enforced. This drastically reduces the amount of configuration and the routing table size.



## How It Works

This feature is implemented using the **ip route kernel** command. When configured, BGP peering is restricted to only the two SF cards with the special route.

When the **blackhole** keyword is configured, it enables the kernel routing engine to block or drop packets going out of the node. This is not limited to any interface and defaults to a wildcard interface.

For information on configuring the BGP Peer Limit feature, see the "Configuring BGP Peer Limit" section.

### Limitations

- This feature support is limited only to the context level.
- There is no support provided at the VRF level.
- This feature is supported only for IPv4.

## Configuring BGP Peer Limit

The following section provides the configuration command to enable or disable the functionality.

### Configuring Packet Processing Card Routes

Use the following CLI commands to add the special (static) route to any two packet processing interfaces (SF cards) defined in the context configuration.

```
configure
 context context_name
 [no] ip route kernel ip_address/ip_address_mask_combo egress_intrfc_name
 cost number
 end
```

#### NOTES:

- **no**: Deletes the added routes.
- **kernel**: Allows static route in the kernel routing table options.
- **ip\_address/ip\_address\_mask\_combo**: Specifies a combined IP address subnet mask bits to indicate what IP addresses the route applies to. *ip\_address\_mask\_combo* must be specified using CIDR notation where the IP address is specified using IPv4 dotted-decimal notation and the mask bits are a numeric value, which is the number of bits in the subnet mask.
- **egress\_intrfc\_name** : Specifies the name of an existing egress interface as an alphanumeric string of 1 through 79 characters.
- **cost number** : Defines the number of hops to the next gateway. The cost must be an integer from 0 through 255 where 255 is the most expensive. Default is 0.
- This functionality is disabled by default.

### Configuring Blackhole Route

Use the following CLI commands to block or drop packets going out of the node.

```
configure
 context context_name
```

```
[no] ip route kernel ip_address/ip_address_mask_combo egress_intrfc_name
cost number blackhole
end
```

**NOTES:**

- **no**: Deletes the added routes.
- **kernel**: Allows static route in the kernel routing table options.
- **ip\_address/ip\_address\_mask\_combo**: Specifies a combined IP address subnet mask bits to indicate what IP addresses the route applies to. *ip\_address\_mask\_combo* must be specified using CIDR notation where the IP address is specified using IPv4 dotted-decimal notation and the mask bits are a numeric value, which is the number of bits in the subnet mask.
- **egress\_intrfc\_name** : Specifies the name of an existing egress interface as an alphanumeric string of 1 through 79 characters. The default is “\*”, that is, a wildcard interface.
- **cost number** : Defines the number of hops to the next gateway. The cost must be an integer from 0 through 255 where 255 is the most expensive. The default is 0.
- **blackhole**: Defines the blackhole route to install in the kernel to to block or drop packets.
- This functionality is disabled by default.

## Monitoring and Troubleshooting

This section provides information regarding the CLI command available in support of monitoring and troubleshooting the feature.

### Show Command(s) and/or Outputs

This section provides information regarding the show command and/or its output in support of this feature.

*show ip route*

This show command CLI now includes the value for the following new field when a static route is added to any two packet processing interfaces (SF cards).

kernel-only

## Bidirectional Forwarding Detection

Bidirectional Forwarding Detection (BFD) is a network protocol used to detect faults between two forwarding engines connected by a link. BFD establishes a session between two endpoints over a particular link. If more than one link exists between two systems, multiple BFD sessions may be established to monitor each one of them. The session is established with a three-way handshake, and is torn down the same way. Authentication may be enabled on the session. A choice of simple password, MD5 or SHA1 authentication is available.



### Important

On the ASR 5500, BFD routes with IPv6 prefix lengths less than /12 and between the range of /64 and /128 are not supported.

## Overview of BFD Support

BFD does not have a discovery mechanism; sessions must be explicitly configured between endpoints. BFD may be used on many different underlying transport mechanisms and layers, and operates independently of all of these. Therefore, it needs to be encapsulated by whatever transport it uses.

Protocols that support some form of adjacency setup, such as OSPF or IS-IS, may also be used to bootstrap a BFD session. These protocols may then use BFD to receive faster notification of failing links than would normally be possible using the protocol's own keepalive mechanism.

In asynchronous mode, both endpoints periodically send Hello packets to each other. If a number of those packets are not received, the session is considered down.

When Echo is active, a stream of Echo packets is sent to the other endpoint which then forwards these back to the sender. Echo can be globally enabled via the **bfd-protocol** command, and/or individually enabled/disabled per interface. This function is used to test the forwarding path on the remote system.

The system supports BFD in asynchronous mode with optional Echo capability via static or BGP routing.



### Important

On an ASR 5500 one of the packet processing cards must be configured as a demux card in order for BFD to function. See the *Configuring a Demux Card* section in the *System Settings* chapter for additional information.

## Configuring BFD

This section describes how to configure and enable basic BFD routing protocol support in the system.

There are several factors affecting the configuration of BFD protocol:

- [Configuring a BFD Context, on page 319](#)
- [Configuring IPv4 BFD for Static Routes, on page 320](#)
- [Configuring IPv6 BFD for Static Routes, on page 320](#)
- [Configuring BFD for Single Hop, on page 320](#)
- [Configuring Multihop BFD, on page 321](#)
- [Scaling of BFD, on page 321](#)
- [Associating BGP Neighbors with the Context, on page 321](#)
- [Associating OSPF Neighbors with the Context, on page 322](#)
- [Associating BFD Neighbor Groups with the BFD Protocol, on page 322](#)
- [Enabling BFD on OSPF Interfaces, on page 322](#)
- [Monitoring BFD Connection for ICSR, on page 322](#)

## Configuring a BFD Context

```
config
 context context_name
 bfd-protocol
 [bfd echo]
 exit
```

Notes:

- Echo function can be optionally enabled for all interfaces in this context.

- 16 BFD sessions per context and 64 per chassis.

## Configuring IPv4 BFD for Static Routes

Enable BFD on an interface.

```
config
 context bfd_context_name
 interface if_name
 ip address ipv4_address ipv4_mask
 bfd interval interval_value min_rx rx_value multiplier multiplier_value
 [bfd echo]
 exit
```

Configure BFD static route.

```
ip route static bfd if_name ipv4_gw_address
```

Add static routes.

```
ip route ipv4_address ipv4_mask
ip route ipv4_address ipv4_mask
```

## Configuring IPv6 BFD for Static Routes

Enable BFD on an Interface

```
config
 context bfd_context_name
 interface if_name
 ipv6 address ipv6_address ipv6_mask
 bfd interval interval_value min_rx rx_value multiplier multiplier_value
 [bfd echo]
 exit
```

Configure BFD static route.

```
ipv6 route static bfd if_name ipv6_gw_address
```

Add static routes.

```
ipv6 route ipv6_address ipv6_mask
ipv6 route ipv6_address ipv6_mask
```



### Important

On the ASR 5500, static routes with IPv6 prefix lengths less than /12 and between the range of /64 and /128 are not supported.

## Configuring BFD for Single Hop

Enable BFD on an interface.

```
config
 context bfd_context_name
 interface if_name
 ip address ipv4_address ipv4_mask
```

```

ipv6 address ipv6_address ipv6_mask
bfd interval interval_value min_rx rx_value multiplier multiplier_value
[bfd echo]
exit

```

Enable BFD on a BGP Neighbor. For additional information, see [Associating BGP Neighbors with the Context, on page 321](#).

Enable BFD on an OSPF Neighbor. For additional information, see [Associating OSPF Neighbors with the Context, on page 322](#).



#### Important

On the ASR 5500, routes with IPv6 prefix lengths less than /12 and between the range of /64 and /128 are not supported.

## Configuring Multihop BFD

Enable BFD on an interface.

```

config
 context bfd_context_name
 interface if_name
 ip address ipv4_address ipv4_mask
 ipv6 address ipv6_address ipv6_mask
 bfd interval interval_value min_rx rx_value multiplier multiplier_value
 [bfd echo]
 exit

```

Configure a Multihop BFD session.

```

bfd-protocol
 bfd multihop peer destination-address interval interval-value multiplier
multiplier-value

```

Enable BFD on a BGP Neighbor. For additional information, see [Associating BGP Neighbors with the Context, on page 321](#).

## Scaling of BFD

Configure an active BFD session using one of the above methods and use same BFD neighbor while configuring the active interface. For additional information, see [Associating BFD Neighbor Groups with the BFD Protocol, on page 322](#).

```

bfd-protocol
 bfd nbr-group-name grp_name active-if-name if_name nexthop_address

```

Apply the same BFD results to one or more passive interfaces.

```

bfd nbr-group-name grp_name passive-if-name if_name nexthop_address
bfd nbr-group-name grp_name passive-if-name if_name nexthop_address

```

## Associating BGP Neighbors with the Context

```

config
 context context_name

```

```

router bgp AS_number
 neighbor neighbor_ip-address remote-as rem_AS_number
 neighbor neighbor_ip-address ebgp-multihop max-hop max_hops
 neighbor neighbor_ip-address update-source update_src_ip-address
 neighbor neighbor_ip-address failover bfd [multihop]

```

Notes:

- Repeat the sequence to add neighbors.

## Associating OSPF Neighbors with the Context

```

config
 context context_name
 router ospf
 neighbor neighbor_ip-address

```

Notes:

- Repeat the sequence to add neighbors.

## Associating BFD Neighbor Groups with the BFD Protocol

```

config
 context context_name
 bfd-protocol
 bfd nbr-group-name grp_name active-if-name if_name nexthop_address
 bfd nbr-group-name grp_name passive-if-name if_name nexthop_address

```

## Enabling BFD on OSPF Interfaces

### All OSPF Interfaces

```

config
 context context_name
 router ospf
 bfd-all-interfaces

```

### Specific OSPF Interface

```

config
 context context_name
 interface interface_name
 broadcast
 ip ospf bfd

```

## Monitoring BFD Connection for ICSR

For ICSR configurations, the following command sequence initiates monitoring of the connection between the primary chassis and the BFD neighbor in the specified context. If the connection drops, the standby chassis becomes active.

```

config
 context context_name

```

```

service-redundancy-protocol
 monitor bfd context context_name { ipv4_address | ipv6_address } {
chassis-to-chassis | chassis-to-router }

```

Notes:

- `ipv4_address | ipv6_address` defines the IP address of the BFD neighbor to be monitored, entered using IPv4 dotted-decimal or IPv6 colon-separated-hexadecimal notation
- **chassis-to-chassis** enables BFD to run between primary and backup chassis on non-SRP links.
- **chassis-to-router** enables BFD to run between chassis and router.

## Saving the Configuration

Save your configuration as described in the *Verifying and Saving Your Configuration* chapter.

## Chassis-to-Chassis BFD Monitoring for ICSR

An operator can configure BFD to more quickly advertise routes during an ICSR switchover. This solution complements the feature that allows the advertising of BGP routes from a Standby ICSR chassis. The overall goal is to support more aggressive failure detection and recovery in an ICSR configuration when implementing of VoLTE.

You must configure the following features for chassis-to-chassis BFD monitoring in ICSR configurations:

- [Enable Primary Chassis BFD Monitoring, on page 323.](#)
- [Set BFD to Ignore ICSR Dead Interval, on page 323.](#)
- [Configure ICSR Switchover Guard Timer, on page 324.](#)
- [Enable BFD Multihop Fall-over, on page 324.](#)
- [Enable Advertising BGP Routes from Standby ICSR Chassis, on page 326.](#)

### Enable Primary Chassis BFD Monitoring

You must enable monitoring of the connection between the primary chassis and specified BFD neighbors. If the connection drops, the standby chassis becomes active. For more information, see [Monitoring BFD Connection for ICSR, on page 322.](#)

### Set BFD to Ignore ICSR Dead Interval

The SRP Configuration mode **bfd-mon-ignore-dead-interval** command causes the standby ICSR chassis to ignore the dead interval and remain in the standby state until all the BFD chassis-to-chassis monitors fail.

Enable this feature in association with BFD chassis-to-chassis monitoring to support more aggressive ICSR failure detection times.

```

configure
 context context_name
 service-redundancy-protocol variable
 bfd-mon-ignore-dead-interval
 end

```

## Configure ICSR Switchover Guard Timer

The SRP Configuration mode **guard timer** command configures the redundancy-guard-period and monitor-damping-period for SRP service monitoring.

Use these guard timers to ensure that local failures, such as card reboots and task restarts, do not result in ICSR events which can be disruptive.

```
configure
 context context_name
 service-redundancy-protocol variable
 guard-timer { aaa-switchover-timers { damping-period seconds |
guard-period seconds } | diameter-switchover-timers { damping-period seconds
| guard-period seconds } | srp-redundancy-timers { aaa { damping-period
seconds | guard-period seconds } | bgp { damping-period seconds | guard-period
seconds } | diam { damping-period seconds | guard-period seconds } }
 end
```

Notes:

- **aaa-switchover-timers** – sets timers that prevent back-to-back ICSR switchovers due to an AAA failure (post ICSR switchover) while the network is still converging.
  - **damping-period** – configures a delay time to trigger an ICSR switchover due to a monitoring failure within the guard-period.
  - **guard-period** – configures the local-failure-recovery network-convergence timer.
- **diameter-switchover-timers** – sets timers that prevent a back-to-back ICSR switchover due to a Diameter failure (post ICSR switchover) while the network is still converging.
  - **damping-period** – configures a delay time to trigger an ICSR switchover due to a monitoring failure within the guard-period.
  - **guard-period** – configures the local-failure-recovery network-convergence timer.
- **srp-redundancy-timers** – sets timers that prevent an ICSR switchover while the system is recovering from a local card-reboot/critical-task-restart failure.
  - **aaa** – local failure followed by AAA monitoring failure
  - **bgp** – local failure followed by BGP monitoring failure
  - **diam** – local failure followed by Diameter monitoring failure

## Enable BFD Multihop Fall-over

A **fall-over bfd multihop mhsess\_name** keyword in the Context Configuration mode ip route and ipv6 route commands enables fall-over BFD functionality for the specified multihop session. The **fall-over bfd** option uses BFD to monitor neighbor reachability and liveness. When enabled it will tear down the session if BFD signals a failure.

```
configure
 context context_name
 ip route { ip_address/ip_mask | ip_address ip_mask } { gateway_ip_address |
next-hop next_hop_ip_address | point-to-point | tunnel } egress intrfc_name [
cost cost] [fall-over bfd multihop mhsess_name] [precedence precedence] [
vrf vrf_name [cost value] [fall-over bfd multihop mhsess_name] [precedence
```



```
precedence] +
end
```

The **ip route** command now also allows you to add a static multihop BFD route.

```
ip route static multihop bfd mhbfd_sess_name local_endpt_ipaddr
remote_endpt_ipaddr
```



### Important

SNMP traps are generated when BFD sessions go up and down (BFDSessUp and BFDSessDown).

## ip route Command

### configure

```
context context_name
ip route { ip_address/ip_mask | ip_address ip_mask } { gateway_ip_address |
next-hop next_hop_ip_address | point-to-point | tunnel } egress_intrfc_name [
cost cost] [fall-over bfd multihop mhsess_name] [precedence precedence] [
vrf vrf_name [cost value] [fall-over bfd multihop mhsess_name] [precedence
precedence] +
end
```

The **ip route** command now also allows you to add a static multihop BFD route.

```
ip route static multihop bfd mhbfd_sess_name local_endpt_ipaddr
remote_endpt_ipaddr
```

## ip routev6 Command

### configure

```
context context_name
ipv6 route ipv6_address/prefix_length { interface name | next-hop ipv6_address
interface name } [cost cost] [fall-over bfd multihop mhsess_name] [
precedence precedence] [vrf vrf_name [cost value] [fall-over bfd multihop
mhsess_name] [precedence precedence]
end
```

The **ipv6 route** command now also allows you to add a static multihop BFD route.

```
ipv6 route static multihop bfd mhbfd_sess_name local_endpt_ipv6addr
remote_endpt_ipv6addr
```

## Adjust BFD Interval

Set the transmit interval (in milliseconds) between BFD packets to meet the convergence requirements of your network deployment.

### configure

```
context context_name
interface interface_name broadcast
bfd interval interval_num min_rx milliseconds multiplier value
end
```

Notes:

- *milliseconds* is an integer from 50 through 10000. (Default 50)

## Enable Advertising BGP Routes from Standby ICSR Chassis

For information on configuring the feature, see [Advertising BGP Routes from a Standby ICSR Chassis](#), on page 313.

## Saving the Configuration

Save your configuration as described in the *Verifying and Saving Your Configuration* chapter.

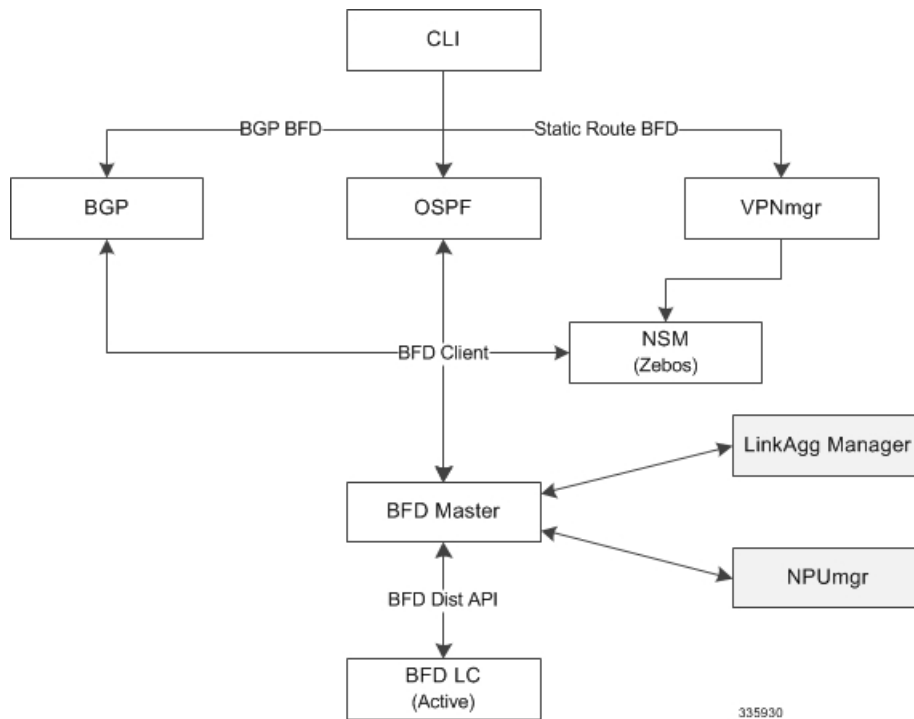
## BFD Support for Link Aggregation Member Links

Member-link based BFD detects individual link failures faster than LACP and reduces the overall session/traffic down period as a result of single member link failure.

## Overview

A BFD Configuration mode CLI command configures BFD interactions with the linkagg task. Once a session is configured, BFD creates per member link BFD sessions and starts sending packets on each of the linkagg member links. If a member link BFD session fails, StarOS notifies failures to the linkagg task.

**Figure 19: BFD Interactions**



If you define a linkagg-peer using a slot number, you may configure a linkagg-peer for a redundant LC (Line Card) slot which must also specify a slot in its member-link configuration. Likewise, if you configure a linkagg-peer without a slot, you must delete it before configuring a peer with a slot specified.

**Important**

Only one IPv4 or IPv6 BFD session-based configuration is allowed per linkagg interface for compliance with RFC 7130.

## Configuring Support for BFD Linkagg Member-links

The **bfd linkagg-peer** command enables member-link BFD and configures the BFD link aggregation (linkagg) session values [RFC 7130].

```

configure
 context context_name
 bfd-protocol
 bfd linkagg-peer linkagg_group_id local-endpt-addr local-endpt_ipaddress
remote-endpt-addr remote_endpt_ipaddress interval tx_interval min_rx rx_interval
multiplier multiplier_value [slot slot_number]
 no bfd linkagg-peer linkagg_group_id [slot slot_number]
 end

```

Notes:

- **linkagg\_group\_id** specifies the LAG number as an integer from 1 through 255.
- **local-endpt-addr** local-endpt\_ipaddress specifies the source address of the multihop BFD session in IPv4 or IPv6 notation.
- **remote-endpt-addr** remote-endpt\_ipaddress specifies the remote address of the multihop BFD session in IPv4 or IPv6 notation.
- **interval** tx\_interval specifies the transmit interval of control packets in milliseconds as an integer from 50 through 10000.
- **min\_rx** rx\_interval specifies the receive interval of control packets in milliseconds as an integer from 50 through 10000.
- **multiplier** multiplier\_value specifies the value used to compute hold-down time as an integer from 3 through 50.
- **slot** slot\_number for redundant active-standby link aggregation, this option specifies the card for which this configuration is intended.

## Saving the Configuration

Save your configuration as described in the *Verifying and Saving Your Configuration* chapter.

## Viewing Routing Information

To view routing information for the current context, run one of the following Exec mode commands;

- **show ip route**: Displays information for IPv4 routes in the current context.
- **show ipv6 route**: Displays information for ipv6 routes in the current context.
- **show ip static-route**: Displays information only for IPv4 static routes in the current contextospf.
- **show ip ospf**: Displays IPv4 OSPF process summary information in the current context.
- **show ipv6 ospf**: Displays IPv6 OSPFv3 process summary information in the current context.

- **show ip bgp**: Displays IPv4 BGP information.

This example shows sample output of the command, **show ip route**.

```
[local]host_name# show ip route
"*" indicates the Best or Used route.

 Destination Nexthop Protocol Prec Cost Interface
*44.44.44.0/24 208.230.231.50 static 1 0 local1
*192.168.82.0/24 0.0.0.0 connected 0 0
*192.168.83.0/24 0.0.0.0 connected 0 0
 208.230.231.0/24 0.0.0.0 ospf 110 10 local1
*208.230.231.0/24 0.0.0.0 connected 0 0 local1
Total route count: 5
```



# CHAPTER 22

## VLANs

---

This chapter provides information on configuring virtual local area networks (VLANs) in support of enhanced or extended services. Product-specific and feature-specific *Administration Guides* provide examples and procedures for configuration of services on the system that may utilize VLANs. You should select the configuration example that best meets your service model before using the procedures described below.



---

**Important**

VLAN – Layer 2 Traffic Management is a Cisco feature that requires a separate license. Contact your Cisco account representative for detailed information on specific licensing requirements. For information on installing and verifying licenses, refer to the *Managing License Keys* section of *Software Management Operations*.

---

- [Overview, on page 329](#)
- [Creating VLAN Tags, on page 331](#)
- [Verifying the Port Configuration, on page 331](#)
- [Configuring Subscriber VLAN Associations, on page 332](#)
- [VLAN-Related CLI Commands , on page 333](#)

## Overview

Virtual LANs (VLANs) provide greater flexibility in the configuration and use of contexts and services.

They are configured as "tags" on a per-port basis and allow more complex configurations to be implemented. The VLAN tag allows a single physical port to be bound to multiple logical interfaces that can be configured in different contexts. Therefore, each Ethernet port can be viewed as containing many logical ports when VLAN tags are employed.



---

**Important**

VLANs are supported in conjunction with subscriber traffic ports on Management I/O (MIO/UMIO/MIO2) cards. The system supports the configuration limits for VLANs as described in *Engineering Rules*.

---

## Overlapping IP Address Pool Support – GGSN

Overlapping IP Address pools allow operators to more flexibly support multiple corporate VPN customers with the same private IP address space without expensive investments in physically separate routers or virtual routers.

The system supports two types of overlapping pools:

- *Resource* pools are designed for dynamic assignment only, and use a VPN tunnel (such as a GRE tunnel) to forward and receive the private IP addresses to and from the VPN.
- *Overlap* pools can be used for both dynamic and static addressing, and use VLANs and a next hop forwarding address to connect to the VPN customer.

To forward downstream traffic to the correct PDP context, the GGSN uses either the GRE tunnel ID or the VLAN ID to match the packet. When forwarding traffic upstream, the GGSN uses the tunnel and forwarding information in the IP pool configuration; overlapping pools must be configured in the APN in such instances.

When a PDP context is created, the IP address is assigned from the IP pool. In this case the forwarding rules are also configured into the GGSN. If the address is assigned statically, when the GGSN confirms the IP address from the pool configured in the APN, the forwarding rules are also applied.

The GGSN can scale to as many actual overlapping pools as there are VLAN interfaces per context, and there can be multiple contexts per GGSN. The limit is the number of IP pools. This scalability allows operators who wish to provide VPN services to customers using the customer's private IP address space, not to be concerned about escalating hardware costs or complex configurations.

## RADIUS VLAN Support – Enhanced Charging Services

VPN customers often use private address space which can easily overlap with other customers. The subscriber addresses are supported with overlapping pools which can be configured in the same virtual routing context.

RADIUS Server and NAS IP addresses do not need to be in separate contexts, thereby simplifying APN and RADIUS configuration and network design. This feature allows the following scenarios to be defined in the same context:

- Overlapping RADIUS NAS-IP addresses for various RADIUS server groups representing different APNs.
- Overlapping RADIUS server IP addresses for various RADIUS servers groups.

Every overlapping NAS-IP address is given a unique next-hop address which is then bound to an interface that is bound to a unique VLAN, thereby allowing the configuration to exist within the same context.

The system forwards RADIUS access requests and accounting messages to the next hop defined for that NAS-IP; the connected routers forward the messages to the RADIUS server. The next hop address determines the interface and VLAN to use. Traffic from the server is identified as belonging to a certain NAS-IP by the port/VLAN combination.

The number of RADIUS NAS-IP addresses that can be configured is limited by the number of loopback addresses that can be configured.

## APN Support – PDN Gateway (P-GW)

P-GW Access Point Name (APN) supports extensive parameter configuration flexibility for the APN. VLAN tagging may be selected by the APN, but are configured in the P-GW independently from the APN.

## Creating VLAN Tags

Use the following example to create VLANs on a port and bind them to pre-existing interfaces. For information on creating interfaces, refer to *System Interfaces and Ports*.

```
config
 port ethernet slot/port
 no shutdown
 vlan vlan_tag_ID
 no shutdown
 bind interface interface_name context_name
 end
```

Notes:

- *Optional:* Configure VLAN-subscriber associations. Refer to [Configuring Subscriber VLAN Associations, on page 332](#) for more information.
- Repeat this procedure as needed to configure additional VLANs for the port.
- Refer to [VLAN-Related CLI Commands , on page 333](#) and the *Command Line Interface Reference* for additional information.
- Save your configuration as described in the *Verifying and Saving Your Configuration* chapter.

## Verifying the Port Configuration

Run the following command to verify the port configuration:

```
[local]host_name# show port info slot/port
```

An example of this command's output when at least one VLAN has been configured for the port is shown below:

```
Port: 5/11
 Port Type : 10G Ethernet
 Role : Service Port
 Description : (None Set)
 Redundancy Mode : Port Mode
 Redundant With : 6/11
 Preferred Port : Non-Revertive
 Physical ifIndex : 85262336
 Administrative State : Enabled
 Configured Duplex : Auto
 Configured Speed : Auto
 Fault Unidirection Mode : 802_3ae clause 46
 Configured Flow Control : Enabled
 Interface MAC Address : 64-9E-F3-69-5B-EA
 SRP Virtual MAC Address : None
 Fixed MAC Address : 64-9E-F3-69-5B-CA
 Link State : Up
 Link Duplex : Full
 Link Speed : 10 Gb
 Flow Control : Enabled
 Link Aggregation Group : None
Untagged:
```

```

Logical ifIndex : 85262337
Operational State : Up, Active
Tagged VLAN: VID 10
Logical ifIndex : 285278210
VLAN Type : Standard
VLAN Priority : 0
Administrative State : Enabled
Operational State : Up, Active
Number of VLANs : 1
SFP Module : Present (10G Base-SR)

```

#### Notes:

- Repeat this sequence as needed to verify additional ports.
- *Optional:* Configure VLAN-subscriber associations. Refer to [Configuring Subscriber VLAN Associations, on page 332](#) for more information.
- Refer to [VLAN-Related CLI Commands , on page 333](#) for additional information.
- Save your configuration as described in the *Verifying and Saving Your Configuration* chapter.

## Configuring Subscriber VLAN Associations

Subscriber traffic can be routed to specific VLANs based on the configuration of their user profile. This functionality provides a mechanism for routing all traffic from a subscriber over the specified VLAN. All packets destined for the subscriber must also be sent using only IP addresses valid on the VLAN or they will be dropped.

## RADIUS Attributes Used

The following RADIUS attributes can be configured within subscriber profiles on the RADIUS server to allow the association of a specific VLAN to the subscriber:

- **SN-Assigned-VLAN-ID:** In the Starent VSA dictionary
- **SN1-Assigned-VLAN-ID:** In the Starent VSA1 dictionary



#### Important

Since the instructions for configuring subscriber profiles differ between RADIUS server applications, this section only describes the individual attributes that can be added to the subscriber profile. Please refer to the documentation that shipped with your RADIUS server for instructions on configuring subscribers.

## Configuring Local Subscriber Profiles

Use the configuration example below to configure VLAN associations within local subscriber profiles on the system.



#### Important

These instructions assume that you have already configured subscriber-type VLAN tags according to the instructions provided in [Creating VLAN Tags, on page 331](#).



```

config
 context context_name
 subscriber name user_name
 ip vlan vlan_id
 end

```

## Verify the Subscriber Profile Configuration

Use the following command to view the configuration for a subscriber profile:

```
[local]host_name# show subscriber configuration username user_name
```

Notes:

- Repeat this command for each subscriber.
- Save your configuration as described in the *Verifying and Saving Your Configuration* chapter.

## VLAN-Related CLI Commands

VLAN-related features and functions are supported across several CLI command modes. The following tables identify commands associated with configuration and monitoring of VLAN-related functions.

For detailed information regarding the use of the commands listed below, see the *Command Line Interface Reference*.

**Table 40: VLAN-Related Configuration Commands**

CLI Mode	Command	Description
AAA Server Group Configuration Mode	<b>radius attribute nas-ip-address</b> address <i>ip_address next-hop-forwarding-address</i> <i>ip_address vlan vlan_id</i>	Sets the RADIUS client to provide the VLAN ID with the nexthop forwarding address to a system when running in single nexthop gateway mode.  <b>Note:</b> To access the <b>vlan</b> keyword, <b>aaa-large configuration</b> must be enabled via the Global Configuration mode.
ACS Charging Action Configuration Mode	<b>ip vlan</b> <i>vlan_id</i>	Configures the VLAN identifier to be associated with the subscriber traffic in the destination context.
Context Configuration Mode	<b>ip pool</b> <i>pool_name</i> <b>next-hop forwarding</b> <b>address</b> <i>ip_address</i> <b>overlap</b> <b>vlanid</b> <i>vlan_id</i>	When a nexthop forwarding address is configured, the <b>overlap</b> <b>vlanid</b> keyword enables support for overlapping IP address pools and associates the pool with the specified VLAN ID.

CLI Mode	Command	Description
Context Configuration Mode	<b>ip routing overlap-pool</b>	Advertises overlap-pool addresses in dynamic routing protocols when overlap pools are configured using VLAN IDs. When enabled, the overlap addresses are added as interface addresses and advertised.
Context Configuration Mode	<b>radius attribute nas-ip-address address ip_address nexthop-forwarding-address ip_address vlan vlan_id</b>	Specifies the VLAN ID to be associated with the next-hop IP address.
Ethernet Interface Configuration Mode	<b>[no] logical-port-statistics</b>	Enables or disables the collection of logical port (VLAN and NPU) bulk statistics for the first 32 configured Ethernet or PVC interface types.
Ethernet Interface Configuration Mode	<b>vlan-map next-hop ipv4_address</b>	Sets a single next-hop IP address so that multiple VLANs can use a single next-hop gateway. The vlan-map is associated with a specific interface.
Ethernet Port Configuration Mode	<b>vlan vlan_id</b>	Enters VLAN Configuration mode.
PVC Configuration Mode	<b>[no] shutdown</b>	Enables or disables traffic over a specified VLAN. See below.
Subscriber Configuration Mode	<b>ip vlan vlan_id</b>	Configures the subscriber VLAN ID that is used with the assigned address for the subscriber session to receive packets. If the IP pool from which the address is assigned is configured with a VLAN ID, this subscriber configured VLAN ID overrides it.
VLAN Configuration Mode	<b>bind interface interface_name context_name</b>	Binds a virtual interface and context to support VLAN service.
VLAN Configuration Mode	<b>[no] ingress-mode</b>	Enables or disables port ingress (incoming) mode.
VLAN Configuration Mode	<b>priority value</b>	Configures an 802.1p VLAN priority bit for ASN-GW service only.
VLAN Configuration Mode	<b>[no] shutdown</b>	Enables or disables traffic over the current VLAN.
VLAN Configuration Mode	<b>vlan-map interface if_name context_name</b>	Associates an IP interface having a VLAN ID with a context.

**Table 41: VLAN-Related Monitoring Commands**

CLI Mode	Command	Description
Exec Mode show commands	<b>clear port</b> <i>slot/port</i> <b>vlan</b> <i>vlan_id</i>	Clears NPU statistics for the port that has a previously configured VLAN ID.
Exec Mode show commands	<b>show logical-port utilization table</b> <b>vlan</b> { <b>5-minute</b>   <b>hourly</b> }	Displays VLAN utilization for a specified collection interval.
Exec Mode show commands	<b>show port info</b> <i>slot/port</i> <b>vlan</b> <i>vlan_id</i>	Displays NPU counters for a previously configured VLAN ID.





## CHAPTER 23

# BGP MPLS VPNs

This chapter describes services that are supported for Border Gateway Protocol (BGP) Multi-Protocol Label Switching (MPLS) Virtual Private Networks (VPNs).



### Important

MPLS is a licensed Cisco feature that requires a separate license. Contact your Cisco account representative for detailed information on specific licensing requirements. For information on installing and verifying licenses, refer to the *Managing License Keys* section of *Software Management Operations*.

It includes the following topics:

- [Introduction, on page 337](#)
- [MPLS-CE Connected to PE, on page 338](#)
- [ASR 5500 as a PE, on page 338](#)
- [IPv6 Support for BGP MPLS VPNs, on page 340](#)
- [VPN-Related CLI Commands , on page 343](#)

## Introduction

Service providers require the ability to support a large number of corporate Access Point Names (APNs) which have a number of different addressing models and requirements. ASR 5500 uses BGP MPLS Layer 3 VPNs to segregate corporate customer APNs in a highly scalable manner. This solution conforms to RFC 4364 – *BGP/MPLS IP Virtual Private Networks (VPNs)*.

The BGP/MPLS solution supports the following scenarios:

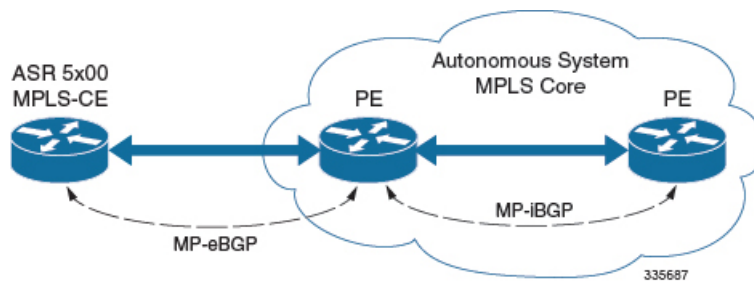
- [MPLS-CE Connected to PE, on page 338](#)
- [ASR 5500 as a PE, on page 338](#)

ASR 5500 also supports VPNv6 as described in RFC 4659 – *BGP-MPLS IP Virtual Private Network (VPN) Extension for IPv6 VPN*. See [IPv6 Support for BGP MPLS VPNs, on page 340](#) for details.

## MPLS-CE Connected to PE

In this scenario the ASR 5500 functions as an MPLS-CE (Customer Edge) network element connected to a Provider Edge (PE) Label Edge Router (LER), which in turn connects to the MPLS core (RFC 4364). See the figure below.

*Figure 20: ASR 5500 MPLS-CE to PE*



The MPLS-CE functions like a PE router within its own Autonomous System (AS). It maintains Virtual Routing and Forwarding (VRF) routes and exchanges VPN route information with the PE via an MP-eBGP (Multi-Protocol-external BGP) session.

The PE is also configured with VRFs and exchanges VPN routes with other PEs in its AS via MP-iBGP (Multi-Protocol-internal BGP) connections and the MPLS-CE via an MP-eBGP connection.

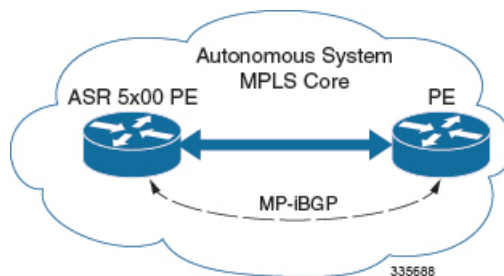
The EBGP connection allows the PE to change next-hop IP addresses and labels in the routes learned from IBGP peers before advertising them to the MPLS-CE. The MPLS-CE in this case uses only MP-eBGP to advertise and learn routes. Label Distribution Protocol (LDP) and Resource Reservation Protocol (RSVP) are not required because of direct-connect EBGP peering. The MPLS-CE in this scenario pushes/pops a single label (learned over the MP-eBGP connection) to/from the PE.

## ASR 5500 as a PE

### Overview

In this scenario, the ASR 5500 functions as a PE router sitting at the edge of the MPLS core. See the figure below.

*Figure 21: ASR 5500 as a PE*



The ASR 5500 eliminates the need for an ASBR or PE as shown in the first two scenarios. In this scenario, two main requirements are introduced: IBGP functionality and MPLS label distribution protocols.

The ASR 5500 can be configured to add two labels:

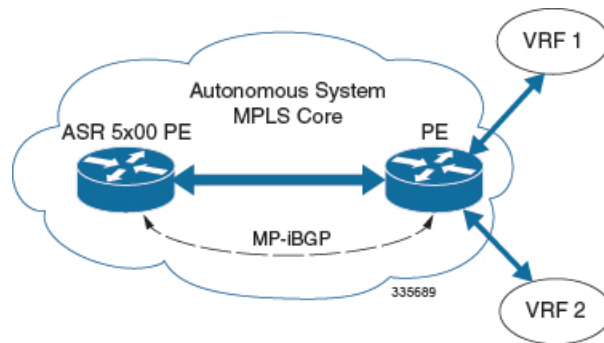
- an outer label learned from LDP or RSVP-TE (RSVP-Traffic Engineering)
- an inner label learned from MP-iBGP

This solution supports traffic engineering and QoS initiated via the ASR 5500.

## Sample Configuration

In this example, VRFs are configured on the ASR 5500 PE and pools are associated with VRFs. The ASR 5500 exchanges VPN routes with its IBGP peers (PE routers) and learns the MPLS paths to reach PEs via LDP. The ASR 5500 forwards the packets to the next-hop with two labels – an inner label learned from PE and an outer label learned from the next hop IBGP neighbor.

**Figure 22: Sample Configuration**



```

mpls ip
 protocol ldp
 enable
 exit
exit

ip vrf vrf1
 mpls traffic-class copy
exit
ip vrf vrf2
 mpls traffic-class value 5
exit

router bgp 300
 ip vrf vrf1
 route-target export 300 1
 route-target import 300 1
 route-distinguisher 300 1
 exit
 ip vrf vrf2
 route-target export 300 2
 route-target import 300 2
 route-distinguisher 300 2
 exit

router-id 2.2.2.2
neighbor 192.168.107.20 remote-as 300

```

```

neighbor 192.168.107.20 update-source node1_loopback

address-family vpnv4
 neighbor 192.168.107.20 activate
 neighbor 192.168.107.20 send-community both
 neighbor 192.168.107.20 next-hop-self
exit

address-family ipv4 vrf vrf1
 redistribute connected
exit

address-family ipv4 vrf vrf2
 redistribute connected
exit

interface interface_to_internet
 ip address 192.168.109.65/24
 mpls ip
exit
router ospf
 network 192.168.109.0/24 area 0.0.0.0
exit

```

# IPv6 Support for BGP MPLS VPNs

## Overview

The ASR 5500 supports VPNv6 as described in RFC 4659 – *BGP-MPLS IP Virtual Private Network (VPN) Extension for IPv6 VPN*.

An IPv6 VPN is connected over an IPv6 interface or sub-interface to the Service Provider (SP) backbone via a PE router. The site can be both IPv4 and IPv6 capable. Each VPNv6 has its own address space which means a given address denotes different systems in different VPNs. This is achieved via a VPNv6 address-family which prepends a Route Distinguisher (RD) to the IP address.

A VPNv6 address is a 24-byte quantity beginning with an 8-byte RD and ending with a 16-byte IPv6 address. When a site is IPv4 and IPv6 capable, the same RD can be used for the advertisement of both IPv4 and IPv6 addresses.

The system appends RD to IPv6 routes and exchanges the labeled IPv6-RD using the VPNv6 address-family. The Address Family Identifier (AFI) and Subsequent Address Family Identifier (SAFI) fields for VPNv6 routes will be set to 2 and 128 respectively.

The IPv6 VPN traffic will be transported to the BGP speaker via IPv4 tunneling. The BGP speaker advertises to its peer a Next Hop Network Address field containing a VPN-IPv6 address whose 8-octet RD is set to zero and whose 16-octet IPv6 address is encoded as an IPv4-mapped IPv6 address (RFC 4291) containing the IPv4 address of the advertising router. It is assumed that only EBGP peering will be used to exchange VPNv6 routes.

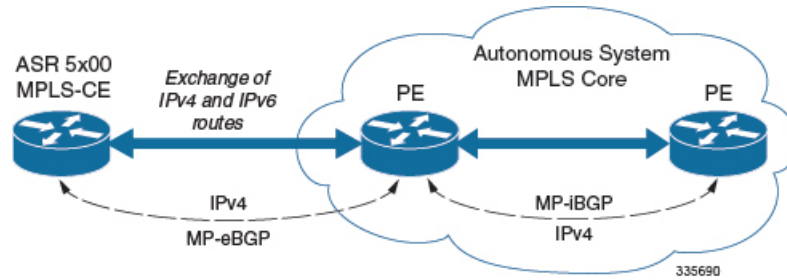
Support for VPN-IPv6 assumes the following:

- Dual Stack (IPv4/IPv6) routing
- IPv6 pools in VRFs
- BGP peering over a directly connected IPv4 interface

See the figure below.



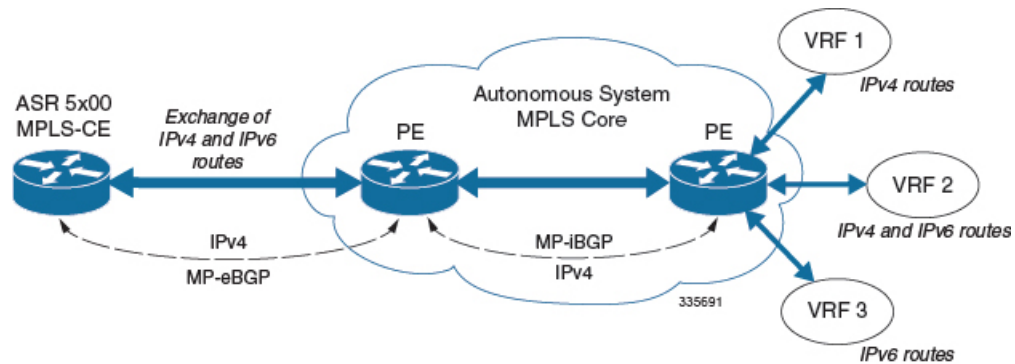
Figure 23: IPv6-RD Support for VPNv6



## Sample Configuration

This example assumes three VRFs. VRF 1 has only IPv4 routes, VRF 2 has both IPv4 and IPv6 routes, and VRF 3 has only IPv6 routes.

Figure 24: VPNv6 Sample Configuration



Configure VRFs.

```
ip vrf vrf1
exit
ip vrf vrf2
exit
ip vrf vrf3
exit
```

Enable MPLS BGP forwarding.

```
mpls bgp forwarding
```

Configure pools.

```
ip pool vrf1-pool 51.52.53.0 255.255.255.0 private 0 vrf vrf1
exit
ip pool vrf2-pool 51.52.53.0 255.255.255.0 private 0 vrf vrf2
exit
ipv6 pool vrf2-v6pool prefix 2005:0101::/32 private 0 vrf vrf2
exit
ipv6 pool vrf3-v6pool prefix 2005:0101::/32 private 0 vrf vrf3
exit
```

Configure interfaces.

```

interface ce_interface_to_rtr
 ip address 192.168.110.90 255.255.255.0
exit
interface ce_v6_interface
 ip address 2009:0101:0101:0101::1/96
exit
interface ce_loopback loopback
 ip address 52.1.2.3 255.255.255.255
exit
interface vrf1-loop loopback
 ip vrf forwarding vrf1
 ip address 1.52.53.54 255.255.255.255
exit
interface vrf2-loop loopback
 ip vrf forwarding vrf2
 ip address 2.52.53.54 255.255.255.255
exit
interface vrf2-v6loop loopback
 ip vrf forwarding vrf2
 ip address 2005:0202:0101::1/128
exit
interface vrf3-v6loop loopback
 ip vrf forwarding vrf3
 ip address 2005:0303:0101::1/128
exit

```

Configure BGP along with address families and redistribution rules.

```

router bgp 800
 router-id 1.1.1.1
 neighbor 192.168.110.20 remote-as 1003
 neighbor 192.168.110.20 activate
 address-family vpnv4
 neighbor 192.168.110.20 activate
 neighbor 192.168.110.20 send-community both
 exit
 address-family vpnv6
 neighbor 192.168.110.20 activate
 neighbor 192.168.110.20 send-community both
 exit
 ip vrf vrf1
 route-distinguisher 800 1
 route-target export 800 1
 route-target import 800 1
 exit
 address-family ipv4 vrf vrf1
 redistribute connected
 redistribute static
 exit
 ip vrf vrf2
 route-distinguisher 800 2
 route-target export 800 2
 route-target import 800 2
 exit
 address-family ipv4 vrf vrf2
 redistribute connected
 redistribute static
 exit
 address-family ipv6 vrf vrf2
 redistribute connected
 redistribute static
 exit
 ip vrf vrf3
 route-distinguisher 800 3
 route-target export 800 3

```

```

 route-target import 800 3
 exit
 address-family ipv6 vrf vrf3
 redistribute connected
 redistribute static
 exit

```

Configure APNs.

```

apn walmart51.com
 selection-mode sent-by-ms
 accounting-mode none
 aaa group walmart-group
 authentication pap 1 chap 2 allow-noauth
 ip context-name Gi_ce
 ip address pool name vrf1-pool
exit
apn amazon51.com
 selection-mode sent-by-ms
 accounting-mode none
 aaa group amazon-group
 authentication pap 1 chap 2 allow-noauth
 ip context-name Gi_ce
 ip address pool name vrf2-pool
 ipv6 address prefix-pool vrf2-v6pool
exit
apn apple51.com
 selection-mode sent-by-ms
 accounting-mode none
 aaa group apple-group
 authentication pap 1 chap 2 allow-noauth ip context-name Gi_ce
 ipv6 address prefix-pool vrf3-v6pool
exit
aaa-group amazon-group
 radius ip vrf vrf2
aaa group default
exit
gtp group default
exit
ip igmp profile default
exit

```

Bind physical interfaces with the port.

## VPN-Related CLI Commands

VPN-related features and functions are supported across several CLI command modes. The following tables identify commands associated with configuration and monitoring of VPN-related functions.

For detailed information regarding the use of the commands listed below, see the *Command Line Interface Reference*.

**Table 42: VPN-Related Configuration Commands**

CLI Mode	Command	Description
BGP Address-Family (IPv4/IPv6) Configuration Mode	<b>neighbor ip_address activate</b>	Enables the exchange of routing information with a peer router.

CLI Mode	Command	Description
BGP Address-Family (IPv4/IPv6) Configuration Mode	<b>neighbor ip_address send community { both   extended   standard }</b>	Sends the community attributes to a peer router (neighbor).
BGP Address-Family (IPv4/IPv6) Configuration Mode	<b>redistribute connected</b>	Redistributes routes into BGP from another protocol as BGP neighbors.
BGP Address-Family (VPNv4) Configuration Mode	<b>neighbor ip_address activate</b>	Enables the exchange of routing information with a peer router.
BGP Address-Family (VPNv4) Configuration Mode	<b>neighbor ip_address send community { both   extended   standard }</b>	Sends the extended-community attribute to a peer router. In VPN, route-distinguisher and route-target are encoded in the BGP extended-community. This command enables sending of BGP routes with extended community to a neighbor.
BGP Address-Family (VRF) Configuration Mode	<b>neighbor ip_address activate</b>	Enables the exchange of routing information with a peer router.
BGP Address-Family (VRF) Configuration Mode	<b>neighbor ip_address send community { both   extended   standard }</b>	Sends the extended-community attribute to a peer router. In VPN, route-distinguisher and route-target are encoded in the BGP extended-community. This command enables sending of BGP routes with extended community to a neighbor.
BGP Address-Family (VRF) Configuration Mode	<b>redistribute connected</b>	Redistributes routes into BGP from another protocol as BGP neighbors.
BGP Configuration Mode	<b>address-family { ipv4 vrf vrf_name   vpnv4 }</b>	Enables the exchange of IPv4 VRF routing information. There is a different mode for each address-family.
BGP Configuration Mode	<b>address-family { ipv6 vrf vrf_name   vpnv6 }</b>	Configures a VPNv6 address family and IPv6 VRF routing in BGP.
BGP Configuration Mode	<b>ip vrf vrf_name</b>	Adds a VRF to BGP and switches to the VRF Configuration mode to allow configuration of BGP attributes for the VRF.
BGP IP VRF Configuration Mode	<b>route-distinguisher { as_value   ip_address } rd_value</b>	Assigns a Route Distinguisher (RD) for the VRF. The RD value must be a unique value on the router for each VRF.

CLI Mode	Command	Description
BGP IP VRF Configuration Mode	<b>route-target</b> { <b>both</b>   <b>import</b>   <b>export</b> } { <i>as_value</i>   <i>ip_address</i> } <i>rt_value</i>	Adds a list of import and export route-target extended communities to the VRF.
Context Configuration Mode	<b>ip pool</b> <i>pool_name</i> <i>addr_range</i> <b>vrf</b> <i>vrf_name</i> [ <b>mpls-label</b> <b>input</b> <i>inlabel1</i> <b>output</b> <i>outlabel1</i> <i>outlabel2</i> ]	Configures a pool into the specified VRF. This parameter must be specified with the Next-Hop parameter. <i>inlabel1</i> is the MPLS label that identifies inbound traffic destined for this pool. <i>outlabel1</i> and <i>outlabel2</i> specify the MPLS labels to be added to packets sent for subscribers from this pool.
Context Configuration Mode	<b>ip vrf</b> <i>vrf_name</i>	Creates a VRF and assigns a VRF-ID. A VRF is created in the router.
Context Configuration Mode	<b>ipv6 pool</b> <i>pool_name</i> <b>vrf</b> <i>vrf_name</i>	Associates the pool with that VRF. <b>Note:</b> By default the configured ipv6 pool will be associated with the global routing domain.
Context Configuration Mode	<b>mpls bgp forwarding</b>	Globally enables MPLS Border Gateway Protocol (BGP) forwarding.
Context Configuration Mode	<b>mpls exp</b> <i>value</i>	Sets the default behavior as Best Effort using a zero value in the 3-bit MPLS EXP header. This value applies to all the VRFs in the context. The default behavior is to copy the DSCP value of mobile subscriber traffic to the EXP header, if there is no explicit configuration for DSCP to EXP (via the <b>mpls map-dscp-to-exp dscp n exp m</b> command). <b>mpls exp</b> disables the default behavior and sets the EXP value to the configured <i>value</i> .
Context Configuration Mode	<b>mpls ip</b>	Globally enables the MPLS forwarding of IPv4 packets along normally routed paths.

CLI Mode	Command	Description
Context Configuration Mode	<b>radius change-authorize-nas-ip ip_address ip_address { encrypted   key } value port port_num mpls input inlabel output outlabel1 outlabel2</b>	Configures COA traffic to use the specified MPLS labels. <i>inlabel</i> identifies inbound COA traffic. <i>outlabel1</i> and <i>outlabel2</i> specify the MPLS labels to be added to the COA response. <i>outlabel1</i> is the inner output label; <i>outlabel2</i> is the outer output label.
Ethernet Interface Configuration Mode	<b>mpls ip</b>	Enables dynamic MPLS forwarding of IP packets on this interface.
Exec Mode	<b>clear ip bgp peer</b>	Clears BGP sessions.
Exec Mode	<b>lsp-ping ip_prefix_FEC</b>	Checks MPLS Label-Switched Path (LSP) connectivity for the specified forwarding equivalence class (FEC). It must be followed by an IPv4 or IPv6 FEC prefix.
Exec Mode	<b>lsp-traceroute ip_prefix_FEC</b>	Discovers MPLS LSP routes that packets actually take when traveling to their destinations. It must be followed by an IPv4 or IPv6 FEC prefix.
IP VRF Context Configuration Mode	<b>mpls map-dscp-to-exp dscp dscp_bit_value exp exp_bit_value</b>	Maps the final differentiated services code point (DSCP) bit value in the IP packet header to the final Experimental (EXP) bit value in the MPLS header for incoming traffic.
IP VRF Context Configuration Mode	<b>mpls map-exp-to-dscp exp exp_bit_value dscp dscp_bit_value</b>	Maps the incoming EXP bit value in the MPLS header to the internal DSCP bit value in IP packet headers for outgoing traffic.
MPLS-IP Configuration Mode	<b>protocol ldp</b>	Creates the MPLS protocol family configuration modes, or configures an existing protocol and enters the MPLS-LDP Configuration Mode in the current context. This command configures the protocol parameters for the MPLS protocol family.
MPLS-LDP Configuration Mode	<b>advertise-labels { explicit-null   implicit-null }</b>	Configure advertisement of Implicit NULL or Explicit NULL label for all the prefixes advertised by the system in this context.

CLI Mode	Command	Description
MPLS-LDP Configuration Mode	<b>discovery</b> { <b>hello</b> { <b>hello-interval</b> <i>seconds</i>   <b>hold-interval</b> <i>seconds</i> }   <b>transport-address</b> <i>ip_address</i> }	Configures the Label Distribution Protocol (LDP) neighbor discovery parameters.
MPLS-LDP Configuration Mode	<b>enable</b>	Enables Label Distribution Protocol (LDP).
MPLS-LDP Configuration Mode	<b>router-id</b> <i>ip_address</i>	Configures the LDP Router ID.
MPLS-LDP Configuration Mode	<b>session timers</b> { <b>hold-interval</b> <i>seconds</i>   <b>keepalive-interval</b> <i>seconds</i> }	Configures the LDP session parameters.

Table 43: VPN-Related Monitoring Commands

CLI Mode	Command	Description
Exec Mode show Commands	<b>show ip bgp neighbors</b>	Displays information regarding BGP neighbors.
Exec Mode show Commands	<b>show ip bgp vpnv4</b> { <b>all</b>   <b>route-distinguisher</b>   <b>vrf</b> }	Displays all VPNv4 routing data, routing data for a VRF or a route-distinguisher.
Exec Mode show Commands	<b>show ip bgp vpnv6</b>	Displays contents of VPNv6 routing table.
Exec Mode show Commands	<b>show ip bgp vpnv6</b> { <b>all</b>   <b>route-distinguisher</b>   <b>vrf</b> }	Displays all VPNv6 routing data, routing data for a VRF or a route-distinguisher.
Exec Mode show Commands	<b>show ip pool</b>	Displays pool details including the configured VRF.
Exec Mode show Commands	<b>show mpls cross-connect</b>	Displays MPLS cross-connect information. MPLS tunnel cross-connects between interfaces and Label-Switched Paths (LSPs) connect two distant interface circuits of the same type via MPLS tunnels that use LSPs as the conduit.
Exec Mode show Commands	<b>show mpls ftn</b> [ <b>vrf</b> <i>vrf_name</i> ]	Displays MPLS FEC-to-NHLFE (FTN) table information.
Exec Mode show Commands	<b>show mpls ftn</b> [ <b>vrf</b> <i>vrf_name</i> ]	Displays contents of the MPLS FTN table for a specified VRF.
Exec Mode show Commands	<b>show mpls ilm</b>	Displays MPLS Incoming Label Map (ILM) table information.

CLI Mode	Command	Description
Exec Mode show Commands	<b>show mpls ldp</b>	Displays the MPLS LDP information.
Exec Mode show Commands	<b>show mpls nexthop-label-forwarding-entry</b>	Displays MPLS Next-Hop Label Forwarding Entry (NHLFE) table information.





## CHAPTER 24

# Content Service Steering

This chapter provides information on configuring Content Service Steering (CSS). The product administration guides provide examples and procedures for configuration of basic services on the system. You should select the configuration example that best meets your service model, and configure the required elements for that model as described in the respective product administration guide, before using the procedures described below.



### Important

Internal CSS is a generic feature, if an ECSv2 license is installed on your system, internal CSS can be enabled. A separate license is not required to enable internal CSS. Contact your local Cisco account representative for information on how to obtain a license.

This chapter contains the following topics:

- [Overview, on page 349](#)
- [Configuring Internal Content Service Steering, on page 349](#)

## Overview

Content Server Selection (CSS) is a StarOS function that defines how traffic will be handled based on the "content" of the data presented by a mobile subscriber (or to a mobile subscriber). CSS is a broad term that includes features such as load balancing, NAT, HTTP redirection, and DNS redirection.

The content server (services) can be either external to the platform or integrated inside the platform.

CSS uses Access Control Lists (ACLs) to redirect subscriber traffic flows. ACLs control the flow of packets into and out of the system. ACLs consist of "rules" (ACL rules) or filters that control the action taken on packets matching the filter criteria.

ACLs are configurable on a per-context basis and applies to a subscriber through either a subscriber profile (or an APN profile in the destination context. For additional information, refer to the *Access Control Lists* chapter.

## Configuring Internal Content Service Steering

To configure and activate a single CSS service for redirecting all of a subscriber's IP traffic to an internal in-line service:

- 
- Step 1** Define an IP ACL as described in [Defining IP Access Lists for Internal CSS, on page 350](#) .
- Step 2** *Optional:* Apply an ACL to an individual subscriber as described in [Applying an ACL to an Individual Subscriber \(Optional\), on page 351](#) .
- Step 3** *Optional:* Apply a single ACL to multiple subscribers as described in [Applying an ACL to Multiple Subscribers \(Optional\), on page 351](#) .
- Step 4** *Optional:* Apply an ACL to multiple subscribers via APNs as described in [Applying an ACL to Multiple Subscriber via APNs, on page 292](#) .
- Step 5** Save your configuration to flash memory, an external memory device, and/or a network location using the Exec mode command `save configuration`. For additional information on how to verify and save configuration files, refer to the *System Administration Guide* and the *Command Line Interface Reference*.

Commands used in the configuration examples in this section provide base functionality to the extent that the most common or likely commands and/or keyword options are presented. In many cases, other optional commands and/or keyword options are available. Refer to the *Command Line Interface Reference* for complete information regarding all commands. Not all commands or keywords/variables may be supported or available. Availability varies on the platform type and installed license(s).

---

## Defining IP Access Lists for Internal CSS

IP ACLs specify what type of subscriber traffic and which direction (uplink, downlink, or both) traffic is redirected. The IP ACL must be specified in the context in which subscriber authentication is performed.



**Caution** To minimize the risk of data loss, do not make configuration changes to ACLs while the system is facilitating subscriber sessions.

---

Use the following configuration example to define an IP ACL for internal CSS; start in the Exec mode of the CLI:

```
configure
 context context_name
 ip access-list acl_name
 redirect css service service_name keywords options
 end
```

Notes:

- `service_name` must be an ACL service name.
- For information on the keywords and options available with the **redirect css service** command, see the *ACL Configuration Mode Commands* chapter in the *Command Line Interface Reference*.
- For IPv6 ACLs, the same configurations must be done in the IPv6 ACL Configuration Mode. See the *IPv6 ACL Configuration Mode Commands* chapter in the *Command Line Interface Reference*.

## Applying an ACL to an Individual Subscriber (Optional)

For information on how to apply an ACL to an individual subscriber, refer to the *Applying an ACL to an Individual Subscriber* section of the *Access Control Lists* chapter.

## Applying an ACL to Multiple Subscribers (Optional)

IP ACLs are applied to subscribers via attributes in their profiles. The subscriber profile can be configured locally on the system or remotely on a RADIUS server.

The system provides for the configuration of subscriber functions that serve as default values when specific attributes are not contained in the individual subscriber's profile. When configured properly, the functions can be used to apply an ACL to:

- All subscribers facilitated within a specific context by applying the ACL to the profile of the subscriber named *default*.
- All subscribers facilitated by specific services by applying the ACL to a subscriber profile and then using the **default subscriber** command to configure the service to use that subscriber as the "default" profile.

## Applying an ACL to the Subscriber Named default (Optional)

For information on how to apply an ACL to the default subscriber, refer to the *Applying an ACL to the Subscriber Named default* section in the *Access Control Lists* chapter.

## Applying an ACL to Service-specified Default Subscribers (Optional)

For information on how to apply an ACL to the subscriber to be used as the "default" profile by various system services, refer to the *Applying an ACL to Service-specified Default Subscribers* section in the *Access Control Lists* chapter.

## Applying an ACL to Multiple Subscribers via APNs (Optional)

IP ACLs are applied to subscribers via attributes in their profiles. The subscriber profile can be configured locally on the system or remotely on a RADIUS server.

To reduce configuration time, ACLs can alternatively be applied to APN templates. When configured, any subscriber packets facilitated by the APN template would then have the associated ACL applied.

For information on how to apply an ACL to multiple subscribers via APNs, refer to the *Applying a Single ACL to Multiple Subscribers via APNs* section in the *Access Control Lists* chapter.





## CHAPTER 25

# Session Recovery

With robust hardware failover and redundancy protection, any hardware or software failures on the system can quickly be corrected. However, software failures can occur for numerous reasons, often without prior indication.

This chapter describes the Session Recovery feature that provides seamless failover and reconstruction of subscriber session information in the event of a hardware or software fault.



### Important

Session Recovery is a licensed Cisco feature. A separate feature license may be required. Contact your Cisco account representative for detailed information on specific licensing requirements. For information on installing and verifying licenses, refer to the *Managing License Keys* section of *Software Management Operations*.

This chapter includes the following sections:

- [How Session Recovery Works, on page 353](#)
- [Additional ASR 5500 Hardware Requirements, on page 356](#)
- [Configuring the System to Support Session Recovery, on page 356](#)
- [Recovery Control Task Statistics, on page 360](#)

## How Session Recovery Works

This section provides an overview of how this feature is implemented and the recovery process.

The Session Recovery feature provides seamless failover and reconstruction of subscriber session information in the event of a hardware or software fault within the system preventing a fully connected user session from being disconnected.

Session recovery is performed by mirroring key software processes (for example, session manager and AAA manager) within the system. These mirrored processes remain in an idle state (standby-mode) wherein they perform no processing, until they may be needed in the event of a software failure (for example, a session manager task aborts).

The system spawns new instances of "standby mode" session and AAA managers for each active control processor (CP) being used. These mirrored processes require both memory and processing resources, which means that additional hardware may be required to enable this feature (see [Additional ASR 5500 Hardware Requirements, on page 356](#)).

Other key system-level software tasks, such as VPN manager, are performed on a physically separate packet processing card to ensure that a double software fault (for example, session manager and VPN manager fails at same time on same card) cannot occur. The packet processing card that hosts the VPN manager process is in active mode and reserved by the operating system for this sole use when session recovery is enabled.

There are two modes of session recovery.

- **Task recovery mode:** Wherein one or more session manager failures occur and are recovered without the need to use resources on a standby packet processing card. In this mode, recovery is performed by using the mirrored "standby-mode" session manager task(s) running on active packet processing cards. The "standby-mode" task is renamed, made active, and is then populated using information from other tasks such as AAA manager. In case of Task failure, limited subscribers will be affected and will suffer outage only until the task starts back up.
- **Full packet processing card recovery mode:** Used when a packet processing card hardware failure occurs, or when a planned packet processing card migration fails. In this mode, the standby packet processing card is made active and the "standby-mode" session manager and AAA manager tasks on the newly activated packet processing card perform session recovery.

Session/Call state information is saved in the peer AAA manager task because each AAA manager and session manager task is paired together. These pairs are started on physically different packet processing cards to ensure task recovery.

There are some situations wherein session recovery may not operate properly. These include:

- Additional software or hardware failures occur during the session recovery operation. For example, an AAA manager fails while the state information it contained was being used to populate the newly activated session manager task.
- A lack of hardware resources (packet processing card memory and control processors) to support session recovery.



### Important

After a session recovery operation, some statistics, such as those collected and maintained on a per manager basis (AAA Manager, Session Manager, etc.) are in general not recovered, only accounting and billing related information is checkpointed and recovered.

Session Recovery is available for the following functions:

- Any session needing L2TP LAC support (excluding regenerated PPP on top of an HA or GGSN session)
- ASR 5500 only – Closed RP PDSN services supporting simple IP, Mobile IP, and Proxy Mobile IP
- ASR 5500 only – eHRPD service (evolved High Rate Packet Data)
- ASR 5500 only – ePDG service (evolved Packet Data Gateway)
- GGSN services for IPv4 and PPP PDP contexts
- HA services supporting Mobile IP and/or Proxy Mobile IP session types with or without per-user Layer 3 tunnels
- ASR 5500 only – HNB-GW: HNB Session over IuH
- ASR 5500 only – HNB-GW: HNB-CN Session over IuPS and IuCS

- ASR 5500 only – HNB-GW: SeGW Session IPSec Tunnel
- ASR 5500 only – HSGW services for IPv4
- IPCF (Intelligent Policy Control Function)
- ASR 5500 only – IPSG-only systems (IP Services Gateway)
- LNS session types (L2TP Network Server)
- MME (Mobility Management Entity)
- ASR 5500 only – NEMO (Network Mobility )
- P-GW services for IPv4
- ASR 5500 only – PDIF (Packet Data Interworking Function)
- PDSN services supporting simple IP, Mobile IP, and Proxy Mobile IP
- S-GW (Serving Gateway)
- SaMOG (S2a Mobility over GTP) Gateway (CGW and MRME)
- ASR 5500 only – SAE-GW (System Architecture Evolution Gateway)
- ASR 5500 only – SGSN services (3G and 2.5G services) for IPv4 and PPP PDP contexts

Session recovery is **not supported** for the following functions:

- Destination-based accounting recovery
- GGSN network initiated connections
- GGSN session using more than 1 service instance
- MIP/L2TP with IPSec integration
- MIP session with multiple concurrent bindings
- Mobile IP sessions with L2TP
- Multiple MIP sessions



---

**Important**

Always refer to the Administration Guides for individual products for other possible session recovery and Interchassis Session Recovery (ICSR) support limitations.

---

When session recovery occurs, the system reconstructs the following subscriber information:

- Data and control state information required to maintain correct call behavior.
- A minimal set of subscriber data statistics; required to ensure that accounting information is maintained.
- A best-effort attempt to recover various timer values such as call duration, absolute time, and others.
- The idle time timer is reset to zero and the re-registration timer is reset to its maximum value for HA sessions to provide a more conservative approach to session recovery.

**Important**

Any partially connected calls (for example, a session where HA authentication was pending but has not yet been acknowledged by the AAA server) are not recovered when a failure occurs.

## Additional ASR 5500 Hardware Requirements

Because session recovery requires numerous hardware resources, such as memory, control processors, NPU processing capacity, some additional hardware may be required to ensure that enough resources are available to fully support this feature.

**Important**

A minimum of four packet processing cards (three active and one standby) per individual chassis is required to use this feature.

To allow for complete session recovery in the event of a hardware failure during a packet processing card migration, a minimum of three active packet processing cards and two standby packet processing cards should be deployed.

To assist you in your network design and capacity planning, consider the following factors:

- Subscriber capacity is decreased depending on the hardware configuration. A fully configured chassis would experience a smaller decrease in subscriber capacity versus a minimally configured chassis.
- The amount by which control transaction processing capacity is reduced.
- The reduction in subscriber data throughput.
- The recovery time for a failed software task.
- The recovery time for a failed packet processing card.

A packet processing card migration may temporarily impact session recovery as hardware resources (memory, processors, etc.) that may be needed are not available during the migration. To avoid this condition, a minimum of two standby packet processing cards should be configured.

## Configuring the System to Support Session Recovery

The following procedures allow you to configure the session recovery feature for either an operational system that is currently in-service (able to accept incoming calls) or a system that is out-of-service (not part of your production network and, therefore, not processing any live subscriber/customer data).

**Important**

The session recovery feature, even when the feature use key is present, is disabled by default on the system.



## Enabling Session Recovery

As noted earlier, session recovery can be enabled on a system that is out-of-service (OOS) and does not yet have any contexts configured, or on an in-service system that is currently capable of processing calls. However, if the system is in-service, it must be restarted before the session recovery feature takes effect.

### Enabling Session Recovery on an Out-of-Service System

The following procedure is for a system that does not have any contexts configured.

To enable the session recovery feature on an out-of-service system, follow the procedure below. This procedure assumes that you begin at the Exec mode prompt.

---

**Step 1** At the Exec mode prompt, verify that the session recovery feature is enabled via the session and feature use licenses on the system by running the **show license info** command.

If the current status of the Session Recovery feature is Disabled, you cannot enable this feature until a license key is installed in the system.

**Step 2** Use the following configuration example to enable session recovery.

```
configure
require session recovery
end
```

**Note** After you configure this command, you must save the configuration and then reload the chassis for the command to take effect. For information on saving the configuration file and reloading the chassis, refer to the System Administration Guide for your deployment.

**Step 3** Save your configuration as described in *Verifying and Saving Your Configuration*.

The system, when started, enables session recovery, creates all mirrored "standby-mode" tasks, and performs packet processing card reservations and other operations automatically.

**Step 4** After the system has been configured and placed in-service, you should verify the preparedness of the system to support this feature as described in [Viewing Session Recovery Status, on page 358](#)

---

### Enabling Session Recovery on an In-Service System

When enabling session recovery on a system that already has a saved configuration, the session recovery commands are automatically placed before any service configuration commands in the configuration file.

To enable the session recovery feature on an in-service system, follow the procedure below. This procedure assumes that you begin at the Exec mode prompt.

---

**Step 1** At the Exec mode prompt, verify that the session recovery feature is enabled via the session and feature use licenses on the system by running the **show license info** command:

If the current status of the Session Recovery feature is Disabled, You cannot enable this feature until a license key is installed in the system.

**Step 2** Use the following configuration example to enable session recovery.

```
configure
 require session recovery
end
```

This feature does not take effect until after the system has been restarted.

**Step 3** Save your configuration as described in *Verifying and Saving Your Configuration*.

**Step 4** Perform a system restart by entering the **reload** command:

The following prompt appears:

```
Are you sure? [Yes|No]:
```

Confirm your desire to perform a system restart by entering **yes**.

The system, when restarted, enables session recovery and creates all mirrored "standby-mode" tasks, performs packet processing card reservations, and other operations automatically.

**Step 5** After the system has been restarted, you should verify the preparedness of the system to support this feature as described in [Viewing Session Recovery Status, on page 358](#)

More advanced users may opt to simply insert the **require session recovery** command syntax into an existing configuration file using a text editor or other means, and then applying the configuration file manually. Exercise caution when doing this to ensure that this command is placed among the first few lines of any existing configuration file; it must appear before the creation of any non-local context.

## Disabling the Session Recovery Feature

To disable the session recovery feature on a system, enter the **no require session recovery** command from the Global Configuration mode prompt.



**Important** If this command is issued on an in-service system, then the system must be restarted by issuing the **reload** command.

## Viewing Session Recovery Status

To determine if the system is capable of performing session recovery, when enabled, enter the **show session recovery status verbose** command from the Exec mode prompt.

The output of this command should be similar to the examples shown below.

```
[local]host_name# show session recovery status
Session Recovery Status:
 Overall Status : SESSMGR Not Ready For Recovery
 Last Status Update : 1 second ago
```

```
[local]host_name# show session recovery status
Session Recovery Status:
 Overall Status : Ready For Recovery
 Last Status Update : 8 seconds ago
```

```
[local]host_name# show session recovery status verbose
```

## Session Recovery Status:

```
Overall Status : Ready For Recovery
Last Status Update : 2 seconds ago
```

```

-----sessmgr----- -----aaamgr----- demux
cpu state active standby active standby active status

1/1 Active 2 1 1 1 0 Good
1/2 Active 1 1 0 0 0 Good
1/3 Active 1 1 3 1 0 Good
2/1 Active 1 1 1 1 0 Good
2/2 Active 1 1 0 0 0 Good
2/3 Active 2 1 3 1 0 Good
3/0 Active 0 0 0 0 1 Good (Demux)
3/2 Active 0 0 0 0 1 Good (Demux)
4/1 Standby 0 2 0 1 0 Good
4/2 Standby 0 1 0 0 0 Good
4/3 Standby 0 2 0 3 0 Good
[local]host_name#
```

## Viewing Recovered Session Information

To view session state information and any session recovery status, enter the following command:

```
[local]host_name# show subscriber debug-info { callid id | msid id | username
name }
```

The following example shows the output of this command both before and after a session recovery operation has been performed. The "Redundancy Status" fields in this example have been bold-faced for clarity.

```
username: user1 callid: 01callb1 msid: 0000100003
Card/Cpu: 4/2
Sessmgr Instance: 7
Primary callline:
Redundancy Status: Original Session
 Checkpoints Attempts Success Last-Attempt Last-Success
 Full: 69 68 29800ms 29800ms
 Micro: 206 206 20100ms 20100ms
Current state: SMGR_STATE_CONNECTED
FSM Event trace:
 State Event
 SMGR_STATE_OPEN SMGR_EVT_NEWCALL
 SMGR_STATE_NEWCALL_ARRIVED SMGR_EVT_ANSWER_CALL
 SMGR_STATE_NEWCALL_ANSWERED SMGR_EVT_LINE_CONNECTED
 SMGR_STATE_LINE_CONNECTED SMGR_EVT_LINK_CONTROL_UP
 SMGR_STATE_LINE_CONNECTED SMGR_EVT_AUTH_REQ
 SMGR_STATE_LINE_CONNECTED SMGR_EVT_IPADDR_ALLOC_SUCCESS
 SMGR_STATE_LINE_CONNECTED SMGR_EVT_AUTH_SUCCESS
 SMGR_STATE_LINE_CONNECTED SMGR_EVT_UPDATE_SESS_CONFIG
 SMGR_STATE_LINE_CONNECTED SMGR_EVT_LOWER_LAYER_UP
Data Reorder statistics
Total timer expiry: 0 Total flush (tmr expiry): 0
 Total no buffers: 0 Total flush (no buffers): 0
 Total flush (queue full): 0 Total flush (out of range): 0
 Total flush (svc change): 0 Total out-of-seq pkt drop: 0
 Total out-of-seq arrived: 0
IPv4 Reassembly Statistics:
 Success: 0 In Progress: 0
 Failure (timeout): 0 Failure (no buffers): 0
 Failure (other reasons): 0
Redirected Session Entries: 2000 Allowed: 0
Current:
```

```

Added: 0 Deleted:
 0
Revoked for use by different subscriber: 0
Peer callline:
Redundancy Status: Recovered Session
Checkpoints Attempts Success Last-Attempt Last-Success
Full: 0 0 0ms 0ms
Micro: 0 0 0ms 0ms
Current state: SMGR_STATE_CONNECTED
FSM Event trace:
State Event
SMGR_STATE_LINE_CONNECTED SMGR_EVT_LOWER_LAYER_UP
SMGR_STATE_CONNECTED SMGR_EVT_AUTH_REQ
SMGR_STATE_CONNECTED SMGR_EVT_AUTH_SUCCESS
SMGR_STATE_CONNECTED SMGR_EVT_REQ_SUB_SESSION
SMGR_STATE_CONNECTED SMGR_EVT_RSP_SUB_SESSION
SMGR_STATE_CONNECTED SMGR_EVT_ADD_SUB_SESSION
SMGR_STATE_CONNECTED SMGR_EVT_AUTH_REQ
SMGR_STATE_CONNECTED SMGR_EVT_AUTH_SUCCESS
SMGR_STATE_CONNECTED SMGR_EVT_AUTH_REQ
SMGR_STATE_CONNECTED SMGR_EVT_AUTH_SUCCESS
SMGR_STATE_CONNECTED SMGR_EVT_AUTH_REQ
SMGR_STATE_CONNECTED SMGR_EVT_AUTH_SUCCESS
SMGR_STATE_CONNECTED SMGR_EVT_AUTH_REQ
SMGR_STATE_CONNECTED SMGR_EVT_AUTH_SUCCESS
SMGR_STATE_CONNECTED SMGR_EVT_AUTH_REQ
SMGR_STATE_CONNECTED SMGR_EVT_AUTH_SUCCESS
Data Reorder statistics
Total timer expiry: 0 Total flush (tmr expiry): 0
Total no buffers: 0 Total flush (no buffers): 0
Total flush (queue full): 0 Total flush (out of range):0
Total flush (svc change): 0 Total out-of-seq pkt drop: 0
Total out-of-seq arrived: 0
IPv4 Reassembly Statistics:
Success: 0 In Progress: 0
Failure (timeout): 0 Failure (no buffers): 0
Failure (other reasons): 0
Redirected Session Entries:
Allowed: 2000 Current: 0
Added: 0 Deleted: 0
Revoked for use by different subscriber: 0

```

## Recovery Control Task Statistics

Recovery Control Task (RCT) statistics show the following:

- Recovery action taken – Migration, Shutdown, Switchover
- Type of event – Planned or Unplanned
- From card to card – slot numbers
- Start time – YYYY-MM-DD+hh:mm:sss.sss
- Duration – seconds
- Card failure device (such as CPU $n$ )
- Card failure reason
- Card is in usable state or not failed
- Recovery action status – Success or failure reason
- If recovery action failed, failure time stamp
- If recovery action failed, failure task facility name

- If recovery action failed, failure instance number

## show rct stats Command

The Exec mode **show rct stats** command employs the following syntax:

```
[local]host_name# show rct stats [verbose]
```

Without the **verbose** keyword, a summary output is displayed as show in the example below:

RCT stats details (Last 1 Actions)

#	Action	Type	From	To	Start Time	Duration	Status
1	Migration(st)	Planned	2	1	2016-Jul-12+13:12:21.865	0.003 sec	Success

RCT stats summary

```

Migrations = 0
Management Card: 0 Average time: 0.000 sec
Packet Card : 1 Average time: 0.006 sec
Switchovers = 1, Average time - 25.855 sec
```

With the **verbose** keyword the detailed statistics show in [Sample Output for show rct stats verbose](#), on page [361](#) are provided.

## Sample Output for show rct stats verbose

```
[local]host_name# show rct stats verbose
```

RCT stats Details (Last 5 Actions)

```
Stats 1:
Action : Migration
Type : Planned
From : 5
To : 6
Start Time : 2017-Apr-04+03:02:00.132
Failure Reason : CPU_CRITICAL_TASK_FAILURE
Failure Device : CPU_0
Is Card Usable : Yes
Recovery Status : Success
Facility : N.A
Instance : N.A
Duration : 066.050 sec
Graceful : Enabled
Recovered [1] : [f:sessmgr, i:6, cpu:50, pid:13170]
Recovered [2] : [f:sessmgr, i:3, cpu:50, pid:13167]
```

RCT stats Details (Last 5 Actions)

```
Stats 2:
Action : Shutdown
From : 12
To : 13
Start Time : 2017-Apr-04+03:02:10.100
Is Card Usable : Yes
Failure Reason : NPU_LC_CONNECT_TOP_FAIL
Failure Device : PAC_LC_CONNECT_HARDWARE
Recovery Status : Success
```

## Sample Output for show rct stats verbose

```

Facility : N.A
Instance : N.A
Duration : 002.901 sec
Graceful : Enabled
Recovered [1]: [f:sessmgr, i:6, cpu:50, pid:13170]
Recovered [2]: [f:sessmgr, i:3, cpu:50, pid:13167]

Stats 3:
Action : Migration
From : 7
To : 11
Start Time : 2017-Apr-04+03:03:40.120
Is Card Usable : Yes
Failure Reason : N.A.
Failure Device : N.A
Recovery Status : Success
Facility : N.A
Instance : N.A
Duration : 003.423 sec
Graceful : Enabled
Recovered [1]: [f:sessmgr, i:6, cpu:50, pid:13170]
Recovered [2]: [f:sessmgr, i:3, cpu:50, pid:13167]

Stats 4:
Action : Migration
From : 7
To : 11
Start Time : 2017-Apr-04+03:03:41.256
Is Card Usable : Yes
Failure Reason : N.A.
Failure Device : N.A
Recovery Status : TASK_MIGRATION_FAIL_PREMIGRATE
Facility : vpnmgr
Instance : 13
Duration : 005.222 sec
Graceful : Enabled
Recovered [1]: [f:sessmgr, i:6, cpu:50, pid:13170]
Recovered [2]: [f:sessmgr, i:3, cpu:50, pid:13167]

Stats 5:
Action : Migration
From : 6
To : 7
Start Time : 2017-Apr-04+04:18:30.106
Is Card Usable : Yes
Failure Reason : N.A.
Failure Device : N.A
Recovery Status : TASK_MIGRATION_FAIL_RENAME
Facility : sessmgr
Instance : 63
Duration : 004.134 sec
Graceful : Enabled
Recovered [1]: [f:sessmgr, i:6, cpu:50, pid:13170]
Recovered [2]: [f:sessmgr, i:3, cpu:50, pid:13167]

RCT stats Summary

Migrations = 3, Average time = 4.260 sec
Switchovers = 0

```



## CHAPTER 26

# Interchassis Session Recovery

This chapter describes how to configure Interchassis Session Recovery (ICSR). The product Administration Guides provide examples and procedures for configuration of basic services on the system. You should select the configuration example that best meets your service model, and configure the required elements for that model as described in the respective product Administration Guide, before using the procedures described below.



### Important

ICSR is a licensed Cisco feature that requires a separate license. Contact your Cisco account representative for detailed information on specific licensing requirements. For information on installing and verifying licenses, refer to the *Managing License Keys* section of *Software Management Operations*.

This chapter discusses the following:

- [Overview, on page 363](#)
- [ICSR Operation, on page 368](#)
- [Configuring ICSR, on page 372](#)
- [Troubleshooting ICSR Operation, on page 386](#)
- [Updating the Operating System, on page 387](#)

## Overview

The ICSR feature provides the highest possible availability for continuous call processing without interrupting subscriber services. ICSR allows the operator to configure geographically distant gateways for redundancy purposes. In the event of a node or gateway failure, ICSR allows sessions to be transparently routed around the failure, thus maintaining the user experience. ICSR also preserves session information and state.

ICSR is implemented through the use of redundant chassis. The chassis are configured as primary and backup, with one being active and one standby. Both chassis are connected to the same AAA server. A checkpoint duration timer controls when subscriber data is sent from the active chassis to the standby chassis. If the active chassis handling the call traffic goes out of service, the standby chassis transitions to the active state and continues processing the call traffic without interrupting the subscriber session.

The chassis determine which is active through a proprietary TCP-based connection known as the Service Redundancy Protocol (SRP) link. The SRP link is used to exchange Hello messages between the primary and backup chassis and must be maintained for proper system operation.

ICSR licenses are currently supported for the following services:

- eHRPD – Evolved High Rate Packet Data
- ePDG – Evolved Packet Data Gateway
- GGSN – Gateway GPRS Support Node
- HA – Home Agent
- P-GW – Packet Data Network Gateway
- PDSN – Packet Data Serving Node
- S-GW – Serving Gateway
- SAEGW – System Architecture Evolution Gateway
- SaMOG – S2a Mobility over GTP

L2TP Access Concentrator (LAC) functionality for ICSR is supported by the following protocol and services:

- eGTP – enhanced GPRS Tunneling Protocol
- GGSN – Gateway GPRS Support Node
- P-GW – Packet Data Network Gateway
- SAEGW – System Architecture Evolution Gateway

L2TP Access Concentrator (LAC) functionality for ICSR is not supported by the following services:

- HA – Home Agent
- PMIP – Proxy Mobile IP

L2TP Network Server (LNS) functionality for ICSR is not supported by any services.




---

**Important** For releases prior to 17.0, ICSR should not be configured on chassis supporting L2TP calls.

---




---

**Important** ICSR support for LAC requires a separate LAC license, as well as an Inter-Chassis Session Recovery license.

---




---

**Important** Contact your Cisco account representative to verify whether a specific service supports ICSR as an option.

---

## Interchassis Communication

Chassis configured to support ICSR communicate using periodic Hello messages. These messages are sent by each chassis to notify the peer of its current state. The Hello message contains information about the chassis such as its configuration and priority. A dead interval is used to set a time limit for a Hello message to be received from the chassis' peer. If the standby chassis does not receive an Hello message from the active chassis within the dead interval, the standby chassis transitions to the active state.

In situations where the SRP link goes out of service, a priority scheme is used to determine which chassis processes the session. The following priority scheme is used:

- route modifier
- chassis priority
- MIO/UMIO/MIO2 MAC address



## Checkpoint Messages

Checkpoint messages are sent from the active chassis to the standby chassis. These messages are sent at specific intervals and contain all the information needed to recreate the sessions on the standby chassis, if that chassis were to become active. Once a session exceeds the checkpoint duration, checkpoint data is collected on the session.

For additional information, refer to the *ICSR Checkpointing* appendix.

## SRP CLI Commands

### Exec Mode CLI Commands

Exec mode **srp** CLI configuration commands can be used to enable, disable and initiate SRP functions. The table below lists and briefly describes these commands. For complete information see the *Exec Mode Commands (D-S)* chapter of the *Command Line Interface Reference*.

**Table 44: srp CLI Commands**

Command	Description
<b>srp disable nack micro-chkpt-cmd</b>	Disables the sending of NACK messages from the standby chassis that may trigger a full checkpoint from the active chassis. Sending full checkpoints increases SRP bandwidth. This command disables the NACK feature for a specific micro-checkpoint which is failing continuously.
<b>srp initiate-audit manual-with-sync</b>	Initiates a forced audit between ICSR chassis. This audit ensures that two ICSR peers are synchronized and identifies any discrepancies prior to scheduled or unscheduled switchover events.
<b>srp initiate-switchover</b>	Executes a forced switchover from active to inactive. When executed on the active chassis, this command switches the active chassis to the inactive state and the inactive chassis to an active state. See Note below.
<b>srp reset-auth-probe-fail</b>	Resets the auth probe monitor failure information to 0.
<b>srp reset-diameter-fail</b>	Resets the Diameter monitor failure information to 0.
<b>srp terminate-post-process</b>	Forcibly terminates post-switchover processing.
<b>srp validate-configuration</b>	Validates the configuration for an active chassis.
<b>srp validate-switchover</b>	Validates that both active and standby chassis are ready for a planned SRP switchover.

**Important**

For release 20.0 and higher, ICSR will verify session manager connectivity on both chassis prior to allowing a manual switchover. If one or more of the session managers in the active chassis is not connected on the standby chassis, the switchover will not be initiated. An error message will appear on the screen noting the number of session managers that are mismatched. The **force** keyword can be used to initiate the switchover despite the mismatch(es). The output of the **show checkpoint statistics verbose** command will not indicate "Ready" for a session manager instance ("smgr inst") in the "peer conn" column for any instance that is not connected to the peer chassis.

## show Commands

Exec mode **show srp** commands display a variety of information related to SRP functions. The table below lists and briefly describes these commands. For complete information on these commands, see the *Exec Mode show Commands (Q-S)* chapter of the *Command Line Interface Reference*.

**Table 45: show srp Commands**

Command	Description
<b>show srp audit-statistics</b>	Displays statistics of an external audit.
<b>show srp call-loss statistics</b>	Displays the history of calls lost during switchover.
<b>show srp checkpoint statistics</b>	Displays check pointing statistics on session redundancy data (session managers, current call recovery records, etc.).
<b>show srp info</b>	Displays Service Redundancy Protocol information (context, chassis state, peer, connection state, etc.).
<b>show srp monitor</b>	Displays SRP monitor information.
<b>show srp statistics</b>	Displays SRP statistics (hello messages sent, configuration validation, resource messages, switchovers, etc.).

For additional information about the output of **show srp** commands, see the *Statistics and Counters Reference*.

## AAA Monitor

AAA servers are monitored using the authentication probe mechanism. AAA servers are considered Up if the authentication-probe receives a valid response. AAA servers are considered Down when the **max-retries count** specified in the configuration of the AAA server has been reached. SRP initiates a switchover when none of the configured AAA servers responds to an authentication probe. AAA probing is only performed on the active chassis.

**Important**

A switchover event caused by an AAA monitoring failure is non-revertible.

If the newly active chassis fails to monitor the configured AAA servers, it remains as the active chassis until one of the following occurs:

- a manual switchover
- another non-AAA failure event causes the system to switchover
- a CLI command is used to clear the AAA failure flag and allow the chassis to switch to standby

## BGP Interaction

The Service Redundancy Protocol implements revertible switchover behavior via a mechanism that adjusts the route modifier value for the advertised loopback/IP Pool routes. The initial value of the route modifier value is determined by the chassis' configured role and is initialized to a value that is higher than a normal operational value. This ensures that in the event of an SRP link failure and an SRP task failure, the correct chassis is still preferred in the routing domain.



### Important

For ICSR you must configure **busyout ip pool** commands in the same order on Active and Standby chassis to avoid SRP validation failures.

The Active and Standby chassis share current route modifier values. When BGP advertises the loopback and IP pool routes, it converts the route modifier into an autonomous systems (AS) path prepend count. The Active chassis always has a lower route modifier, and thus prepends less to the AS-path attribute. This causes the route to be preferred in the routing domain.

If communication on the SRP link is lost, and both chassis in the redundant pair are claiming to be Active, the previously Active chassis is still preferred since it is advertising a smaller AS-path into the BGP routing domain. The route modifier is incremented as switchover events occur. A threshold determines when the route modifier should be reset to its initial value to avoid rollover.

## Requirements

ICSR configurations require the following:

- Two chassis configured for the same service types. The services must be bound on an SRP-activated loopback interface.
- Both chassis must have identical hardware.
- Three contexts:
  - **Redundancy** – to configure the primary and backup chassis redundancy.
  - **Source** – AAA configuration of the specified nas-ip-address must be the IP address of an interface bound to an HA, or any core network service configured within the same context.
  - **Destination** – to configure monitoring and routing to the PDN.
- Border Gateway Protocol (BGP) – ICSR uses the route modifier to determine the chassis priority.

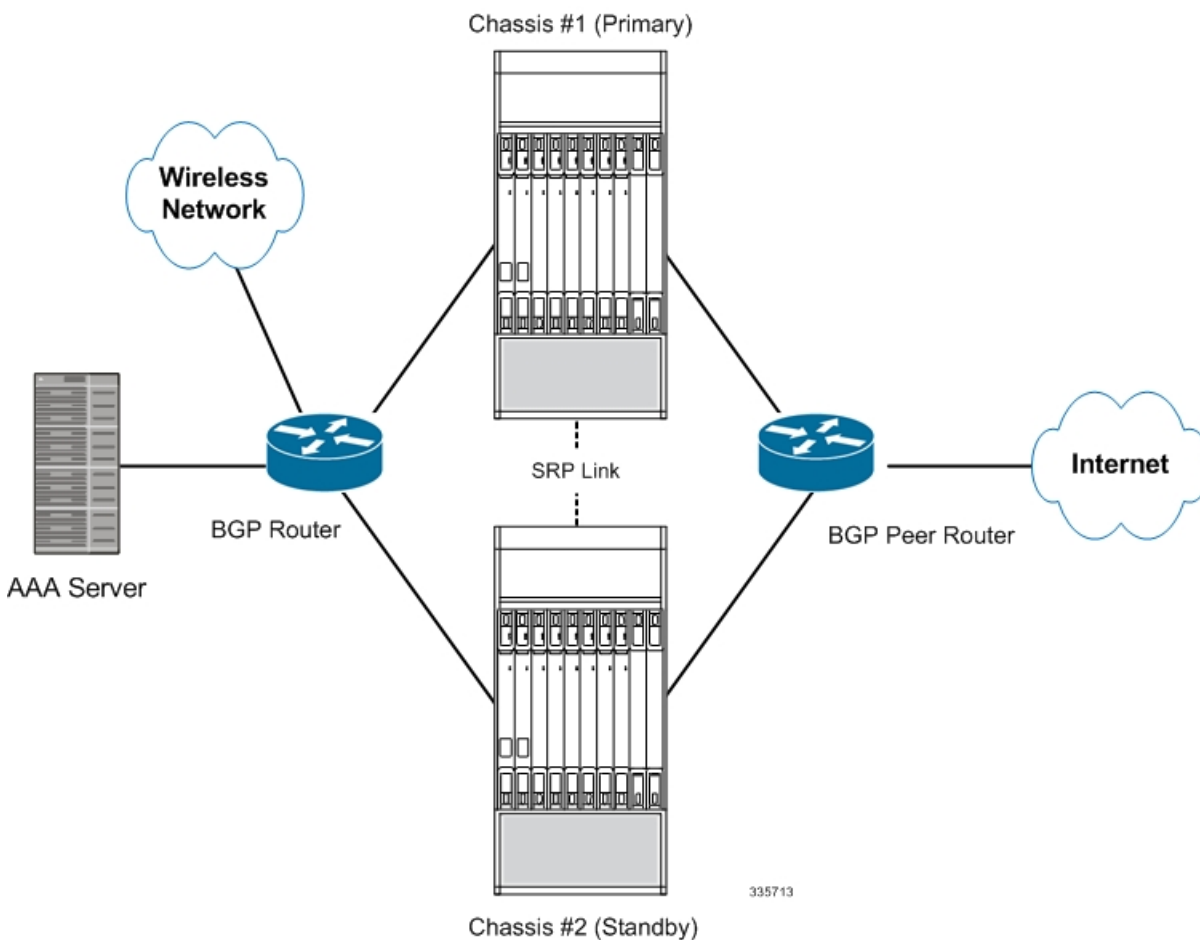


**Important** ICSR is a licensed Cisco feature. Verify that each chassis has the appropriate license before using these procedures. To do this, log in to both chassis and execute a **show license information** command. Look for "Inter-Chassis Session Recovery". If the chassis is not licensed, please contact your Cisco account representative.

RADIUS and Diameter protocols can be monitored to trigger a switchover.

The following figure shows an ICSR network.

Figure 25: ASR 5500 ICSR Network

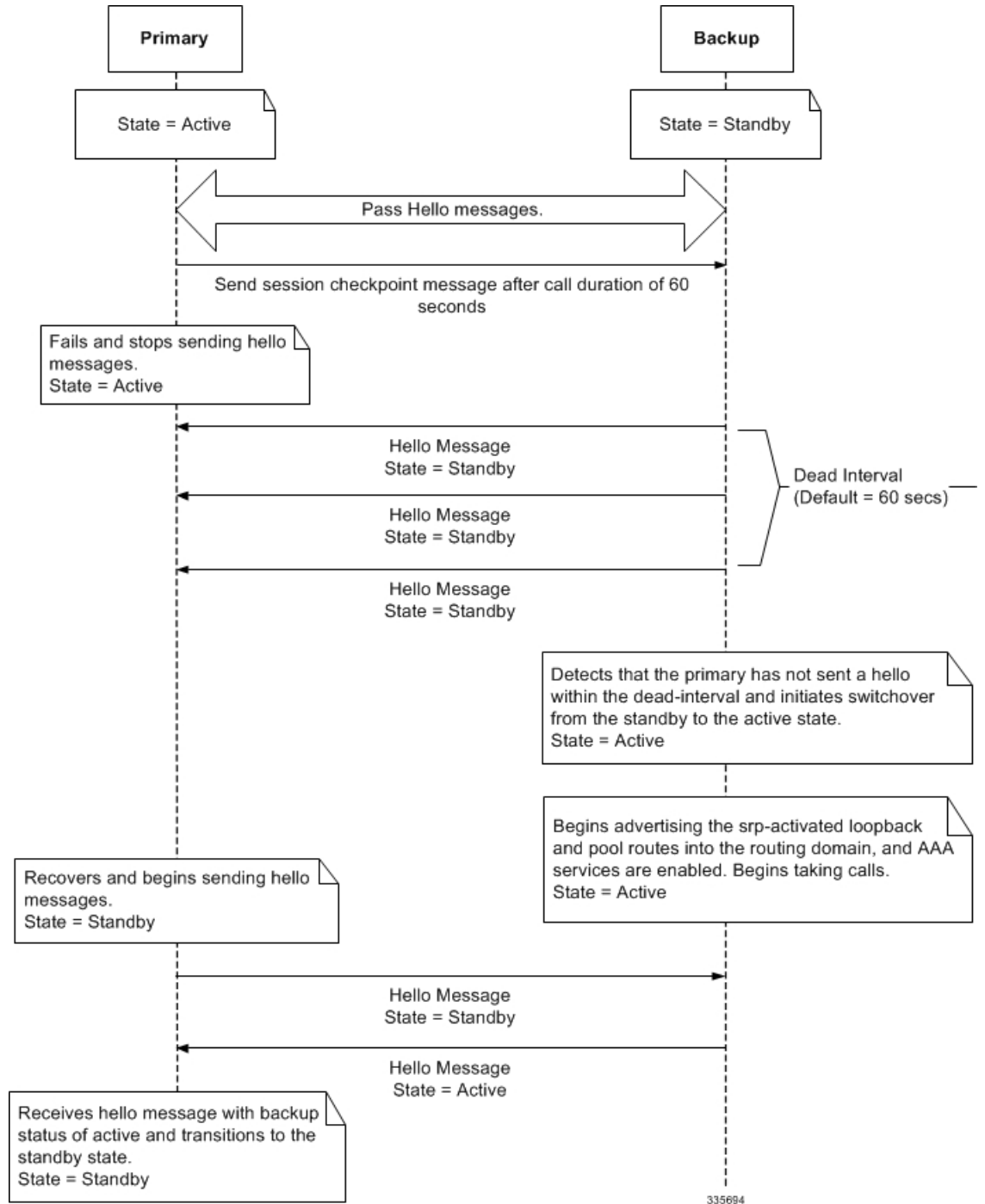


## ICSR Operation

This section shows operational flows for ICSR.

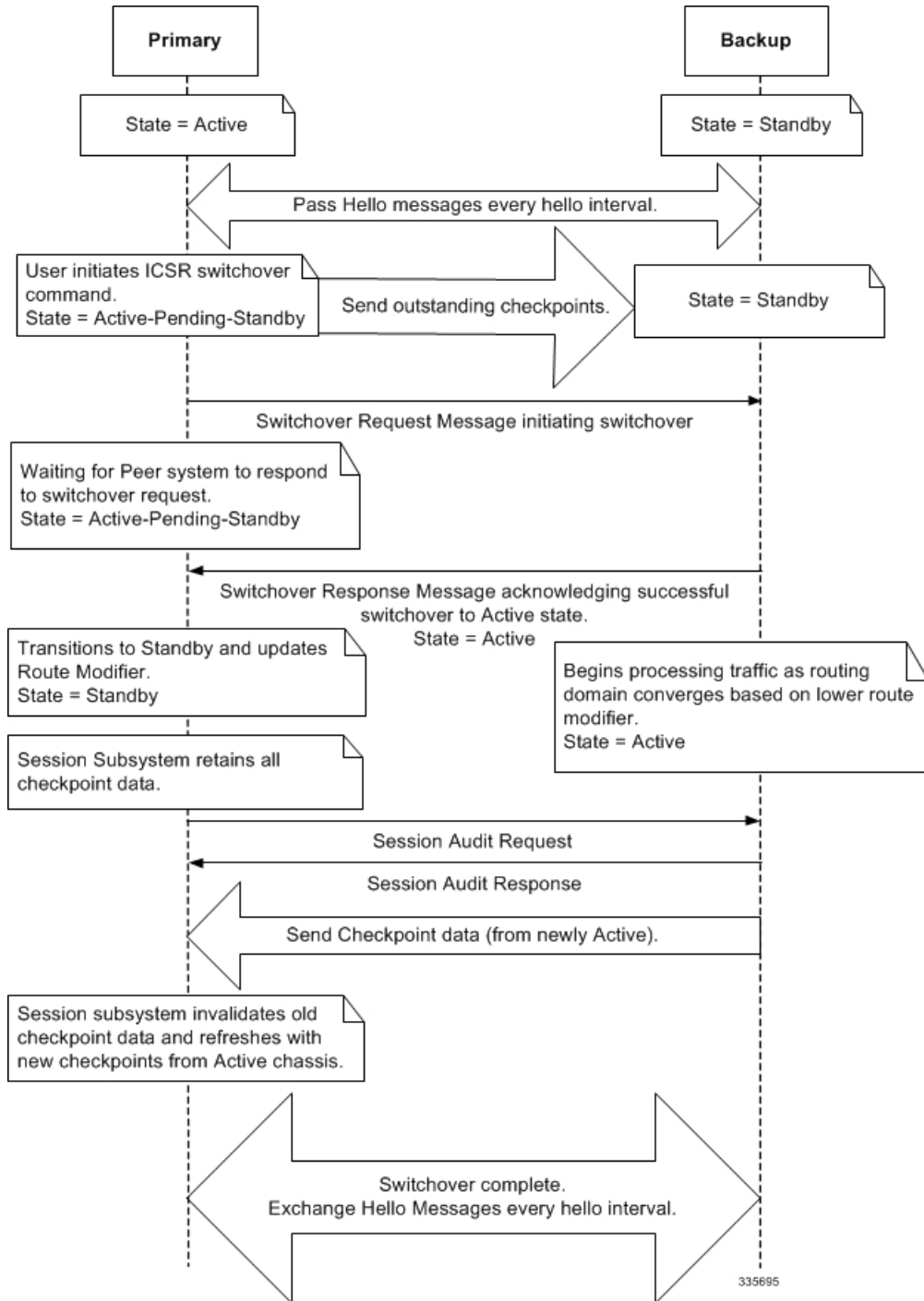
The following figure shows an ICSR process flow due to a primary failure.

Figure 26: ICSR Process Flow (Primary Failure)



The following figure shows an ICSR process flow due to a manual switchover.

Figure 27: ICSR Process Flow (Manual Switchover)



335695

## Chassis Initialization

When the chassis are simultaneously initialized, they send Hello messages to their configured peer. The peer sends a response, establishes communication between the chassis, and messages are sent that contain configuration information.

During initialization, if both chassis are misconfigured in the same mode - both active (primary) or both standby (backup), the chassis with the highest priority (lowest number set with the ICSR **priority** command) becomes active and the other chassis becomes the standby.

If the chassis priorities are the same, the system compares the two MAC addresses and the chassis with the higher MIO/UMIO/MIO2 MAC address becomes active. For example, if the chassis have MAC addresses of *00-02-43-03-1C-2B* and *00-02-43-03-01-3B*, the last 3 sets of octets (the first 3 sets are the vendor code) are compared. In this example, the *03-1C-2B* and *03-01-3B* are compared from left to right. The first pair of octets in both MAC addresses are the same, so the next pairs are compared. Since the *01* is lower than the *1C*, the chassis with the MIO/UMIO/MIO2 MAC address of *00-02-43-03-1C-2B* becomes active and the other chassis the standby.

## Chassis Operation

This section describes how the chassis communicate, maintain subscriber sessions, and perform chassis switchover.

### Chassis Communication

If one chassis is in the active state and one in the standby state, they both send Hello messages at each hello interval. Subscriber sessions that exceed the checkpoint session duration are included in checkpoint messages that are sent to the standby chassis. The checkpoint message contains subscriber session information so if the active chassis goes out of service, the backup chassis becomes active and is able to continue processing the subscriber sessions. Additional checkpoint messages occur at various intervals whenever subscriber session information is updated on the standby chassis.

The SRP Configuration mode **checkpoint session** command includes a number of keywords that enable you to:

- Set the type of compression algorithm to be used for SRP payload messages.
- Set the amount of time the chassis waits before check pointing an existing call session. Checkpoints can be separately set for IMS and/or non-IMS sessions.
- Configure the interval between the sending of macro-checkpoints (full checkpoints) between the active and standby chassis.

For additional information see the *Service Redundancy Protocol Configuration Mode Commands* chapter in the *Command Line Interface Reference*.

### Chassis Switchover

If the active chassis goes out of service, the standby chassis continues to send Hello messages. If the standby chassis does not receive a response to the Hello messages within the dead interval, the standby chassis initiates a switchover. During the switchover, the standby chassis begins advertising its srp-activated loopback and pool routes into the routing domain. Once the chassis becomes active, it continues to process existing AAA services and subscriber sessions that had checkpoint information, and is also able to establish new subscriber sessions.

When the primary chassis is back in service, it sends Hello messages to the configured peer. The peer sends a response, establishes communication between the chassis, and sends Hello messages that contain configuration information. The primary chassis receives an Hello message that shows the backup chassis state as active and then transitions to standby. The Hello messages continue to be sent to each peer, and checkpoint information is now sent from the active chassis to the standby chassis at regular intervals.

When chassis switchover occurs, the session timers are recovered. The access gateway session recovery is recreated with the full lifetime to avoid potential loss of the session and the possibility that a renewal update was lost in the transitional checkpoint update process.

## Configuring ICSR



### Important

The ICSR configuration must be the same on the primary and backup chassis. If each chassis has a different Service Redundancy Protocol (SRP) configuration, the session recovery feature does not function and sessions cannot be recovered when the active chassis goes out of service.

This section describes how to configure basic ICSR on each chassis. For information on commands that configure additional parameters and options, refer to the *Command Line Interface Reference*.



### Important

For releases prior to StarOS 17.0, ICSR should not be configured for chassis supporting L2TP calls.

The procedures described below assume the following:

- The chassis have been installed and configured with core network services.

For more configuration information and instructions on configuring services, refer to the respective product Administration Guide.

- In addition, the IP address pools must be **srp activated**.
- AAA server is installed, configured and accessible by both chassis.

For more information on configuring the AAA server, refer to the *AAA Interface Administration and Reference*.

- BGP router installed and configured. See *Routing* for more information on configuring BGP services.

To configure ICSR on a primary and/or backup chassis:

- 
- Step 1** Configure the SRP context by applying the example configuration in [Configuring the Service Redundancy Protocol \(SRP\) Context, on page 373](#).
  - Step 2** Modify the source context of the core network service by applying the example configuration in [Modifying the Source Context for ICSR, on page 382](#).
  - Step 3** Modify the destination context of core network service by applying the example configuration in [Modifying the Destination Context for ICSR, on page 383](#).
  - Step 4** *Optional:* Disable bulk statistics collection on the standby system by applying the example configuration in [Disabling Bulk Statistics Collection on a Standby System, on page 385](#).



- Step 5** Verify your primary and backup chassis configuration as described in [Verifying the Primary and Backup Configuration, on page 385](#).
- Step 6** Save your configuration as described in *Verifying and Saving Your Configuration*.

---

## Configuring the Service Redundancy Protocol (SRP) Context

To configure the system to work with ICSR:

- Step 1** Create the chassis redundancy context and bind it to the IP address of the primary chassis by applying the example configuration in [Creating and Binding the SRP Context, on page 373](#). For VPC-DI instances, this should be the IP address of the active CF in the primary VPC-DI instance.
- Step 2** Configure the chassis redundancy context with priority, chassis mode, hello interval, dead-interval and peer IP address by applying the example configuration in [Configuring SRP Context Parameters, on page 374](#).
- Step 3** Configure the SRP context with interface parameters (including interface name, IP address and port number) for interchassis communication by applying the example configuration in [Configuring the SRP Context Interface Parameters, on page 379](#).
- Step 4** Verify your SRP context configuration as described in [Verifying SRP Configuration, on page 382](#).
- Step 5** Save your configuration as described in *Verifying and Saving Your Configuration*.

---

## Creating and Binding the SRP Context

Use the example below to create the SRP context and bind it to primary chassis IP address:



---

**Important** ICSR is configured on two chassis. Be sure to create the redundancy context on both systems. CLI commands must be executed on both systems. Log onto both chassis before continuing. Always make configuration changes on the primary chassis first. Before starting this configuration, identify which chassis to configure as the primary and use that login session.

---



---

**Important** ICSR is configured on two VPC-DI instances. Be sure to create the redundancy context on both systems. CLI commands must be executed on both systems. Log onto both active CFs before continuing. Always make configuration changes on the active CF in the primary VPC-DI instance first. Before starting this configuration, identify which VPC-DI to configure as the primary and use that login session.

---

```
configure
context srp_ctxt_name [-noconfirm]
service-redundancy-protocol
bind address ip_address
end
```

Notes:

- ICSR should be configured and maintained in a separate context.

- Be sure to bind the local IP address to the primary chassis. When configuring the backup chassis, be sure to bind the local IP address to the backup chassis.

## Configuring SRP Context Parameters



### Important

CLI commands must be executed on both chassis. Log onto both chassis before continuing. Always make configuration changes on the primary chassis first.

### Basic Parameters

This configuration assigns a chassis mode and priority, and also configures the redundancy link between the primary and backup chassis:

```
configure
context srp_ctxt_name
 service-redundancy-protocol
 chassis-mode { primary | backup }
 priority priority
 peer-ip-address ip_address
 hello-interval dur_sec
 dead-interval dead_dur_sec
 end
```

Notes:

- ICSR should be configured and maintained in a separate context.
- When assigning the chassis mode on the backup chassis be sure to enter the **backup** keyword.
- The **checkpoint** command sets the amount of time the chassis waits before check pointing an existing call session. Checkpoints can be set for IMS (VoLTE) and/or non-IMS sessions. The checkpoint is a snapshot of the current application state that can be used to restart its execution in case of failure. The default setting is 60 seconds.
- The **priority** determines which chassis becomes active in the event that both chassis are misconfigured with the same chassis mode; see [Chassis Initialization, on page 371](#). The higher priority chassis has the lower number. Be sure to assign different priorities to each chassis.
- Enter the IP chassis of the backup chassis as the **peer-ip-address** to the primary chassis. Assign the IP address of the primary chassis as the **peer-ip-address** to the backup chassis.
- The **dead-interval** must be at least three times greater than the **hello-interval**. For example, if the hello interval is 10, the dead interval should be at least 30. System performance is severely impacted if the hello interval and dead interval are not set properly. An optional **delay-interval** command allows you to delay the start dead-interval for an interval following the loading of configuration files.

### SRP Redundancy, AAA and Diameter Guard Timers

Guard timers ensure that local failures, such as reboots and task restarts, do not result in ICSR events which can be disruptive.

The **guard timer** command configures the redundancy-guard-period and monitor-damping-period for SRP service monitoring.

```

configure
 context context_name
 service-redundancy-protocol variable
 guard-timer { aaa-switchover-timers { damping-period seconds |
guard-period seconds } | diameter-switchover-timers { damping-period seconds
| guard-period seconds } | srp-redundancy-timers { aaa { damping-period
seconds | guard-period seconds } | bgp { damping-period seconds | guard-period
seconds } | diam { damping-period seconds | guard-period seconds } }
 end

```

Notes:

- **aaa-switchover-timers** – sets timers that prevent back-to-back ICSR switchovers due to an AAA failure (post ICSR switchover) while the network is still converging.
  - **damping-period** – configures a delay time to trigger an ICSR switchover due to a monitoring failure within the guard-period.
  - **guard-period** – configures the local-failure-recovery network-convergence timer.
- **diameter-switchover-timers** – sets timers that prevent a back-to-back ICSR switchover due to a Diameter failure (post ICSR switchover) while the network is still converging.
  - **damping-period** – configures a delay time to trigger an ICSR switchover due to a monitoring failure within the guard-period.
  - **guard-period** – configures the local-failure-recovery network-convergence timer.
- **srp-redundancy-timers** – sets timers that prevent an ICSR switchover while the system is recovering from a local card-reboot/critical-task-restart failure.
  - **aaa** – local failure followed by AAA monitoring failure
  - **bgp** – local failure followed by BGP monitoring failure
  - **diam** – local failure followed by Diameter monitoring failure

## DSCP Marking of SRP Messages

You can enable separate DSCP marking of SRP control and checkpoint messages. The **dscp-marking** command sets DSCP marking values for SRP control and checkpoint (session maintenance) messages.

```

configure
 context context_name
 service-redundancy-protocol
 dscp-marking { control | session } dscp_value

```

Notes:

- *dscp\_value* can be:
  - **af11** – Assured Forwarding Class 1 low drop PHB (Per Hop Behavior)
  - **af12** – Assured Forwarding Class 1 medium drop PHB
  - **af13** – Assured Forwarding Class 1 high drop PHB
  - **af21** – Assured Forwarding Class 2 low drop PHB
  - **af22** – Assured Forwarding Class 2 medium drop PHB

- **af23** – Assured Forwarding Class 2 high drop PHB
- **af31** – Assured Forwarding Class 3 low drop PHB
- **af32** – Assured Forwarding Class 3 medium drop PHB
- **af33** – Assured Forwarding Class 3 high drop PHB
- **af41** – Assured Forwarding Class 4 low drop PHB
- **af42** – Assured Forwarding Class 4 medium drop PHB
- **af43** – Assured Forwarding Class 4 high drop PHB
- **be** – Best effort Per-Hop-Behaviour (default)
- **cs1** – Class selector 1 PHB
- **cs2** – Class selector 2 PHB
- **cs3** – Class selector 3 PHB
- **cs4** – Class selector 4 PHB
- **cs5** – Class selector 5 PHB
- **cs6** – Class selector 6 PHB
- **cs7** – Class selector 7 PHB
- **ef** – Expedited Forwarding PHB, for low latency traffic

## Optimizing Switchover Transitions

There are several SRP configuration options that reduce the transition time from the active to standby gateways (primarily P-GW) in support of VoLTE traffic.



### Important

These features require an updated ICSR license to support the enhancements. Contact your Cisco account representative for additional information.

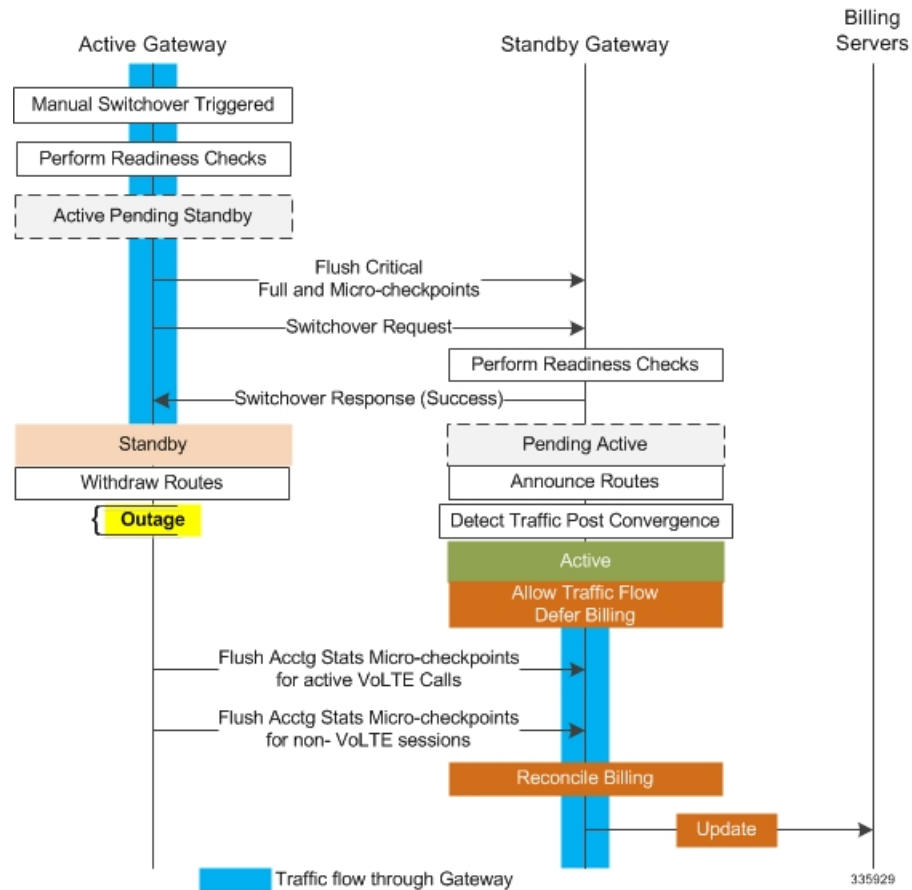
## Allow Non-VoLTE Traffic During ICSR Switchover

The ICSR framework reduces switchover disruption for VoLTE traffic by enabling VoLTE traffic on the newly active gateway prior to reconciling the billing information and enabling communication with the newly active gateway when accounting is not deemed critical.

This functionality extends to all other traffic, including data sessions and default bearer traffic for IMS/e911. The following ICSR functionality is provided for all non-VoLTE data traffic:

- When a switchover occurs, the newly active gateway forwards all traffic the moment the gateway becomes active.
- External communication with billing servers is deferred. See the traffic flow diagram below.
- When the newly active gateway receives all billing-related checkpointing information from the previously active gateway, it reconciles the billing data before communicating with external billing servers OCS (Online Charging System) or OFCS (Offline Charging System).

Figure 28: Call Flow: Reduce Non-VoLTE Data Outage



The **switchover allow-all-data-traffic** SRP Configuration mode CLI command allows all data traffic (VoLTE and non-VoLTE) during switchover transition. This command overwrites the **switchover allow-volte-data-traffic** command if enabled on a P-GW.

#### configure

```
context context_name
 service-redundancy-protocol
 switchover allow-all-data-traffic
```



#### Important

The **switchover allow-all-data-traffic** command must be run on both chassis to enable this feature.

The **switchover allow-volte-data-traffic** SRP Configuration mode CLI command allows VoLTE data traffic during ICSR switchover transition.

#### configure

```
context context_name
 service-redundancy-protocol
 switchover allow-volte-data-traffic [maintain-accounting]
```

Notes:

- When **maintain-accounting** is enabled, accounting accuracy is maintained for VoLTE calls. VoLTE data is allowed on the active gateway after VoLTE accounting statistics are flushed.

## Allow All Data Traffic

The SRP Configuration mode **switchover allow-all-data-traffic** command allows all data traffic (VoLTE and non-VoLTE) during switchover transition. This command overwrites the **switchover allow-volte-data-traffic** command if enabled on a P-GW. This feature reduces data traffic outage during the switchover.




---

**Important** This CLI command must be run on both the active and standby chassis to enable this feature.

---

All data traffic is allowed on the active chassis during flushing and internal auditing. The billing information is reconciled in the background once the flush is complete.

## Allow Early Active Transition

The SRP Configuration mode **switchover allow-early-active-transition** command enables early transition to active state during an ICSR switchover. By default this feature is disabled.

Use this command in concert with the **switchover allow-all-data-traffic** or **allow-volte-data-traffic** (without **maintain accounting** option) command to further reduce data outage during a planned switchover. The outage window is the amount time between initiating an ICSR switchover and when the newly active chassis starts processing data.




---

**Important** You must enable one of the commands identified above on both ICSR chassis prior to enabling this command.

---

## Graceful Cleanup of ICSR After Audit of Failed Calls

During an Audit on the gateways (P-GW/S-GW/GGSN/SAE-GW) after Session Recovery or an ICSR event, if any critical information, internally or externally related to a subscriber session seems inconsistent, ICSR will locally purge the associated session information.

Since external gateways (peer nodes) are unaware of the purging of this session, the UE session may be maintained at other nodes. This leads to hogging of resources external to the gateway and an unreachable UE for VoLTE calls.

When this feature is enabled, graceful cleanup for an ICSR audit of failed calls occurs. External signaling notifies peers of session termination before purging the session. The gateway will attempt to notify external peers of the removal of the session. External nodes to the local gateway include S-GW, P-GW, SGSN, MME, AAA, PCRF and IMSA.

Audit failure can occur because of missing or incomplete session information. Therefore, only the peers for which the information is available will be notified.

The **require graceful-cleanup-during-audit-failure** Global Configuration mode CLI command enables or disables the graceful cleanup feature.

```
configure
 require graceful-cleanup-during-audit-failure [del-cause non-ims-apn
 { system-failure | none }]
```

## Optimization of Switchover Control Outage Time

The ICSR framework minimizes control outage time associated with the flushing of critical full checkpoint statistics, network convergence and internal auditing.

The amount of time consumed by the following activities affects control outage time during switchover:

- **Critical Flush** – During the Active to Pending-Standby transition, all sessmgrs flush any pending critical FCs (Full Checkpoints). During this time, the active chassis drops all control packets. If control signaling is allowed during this stage, a call may get disconnected based on the control message type and accounting information will be lost.
- **Network Convergence** – This encompasses the amount of time taken to update routes and send control/data to the newly active chassis. Control messages are dropped during the transition.
- **Accounting Flush** – During this flush stage data counts are synchronized between chassis. If control signaling is allowed during this flush, the call may get disconnected based on the control message type, and accounting information will be lost for calls that existed before switchover.
- **Audit** – During audit new calls are not allowed because synchronization of call resources may result in clearing of the calls.

The **switchover control-outage-optimization** CLI command allows new calls during the Accounting Flush, as soon as the Audit is completed. This SRP Configuration mode command enables the quicker restoration of control traffic (call-setup, modification, deletion) following an ICSR switchover.

```
configure
context context_name
 service-redundancy-protocol
 switchover control-outage-optimization
end
```

## Configuring the SRP Context Interface Parameters

This procedure configures the communication interface with the IP address and port number within the SRP context. This interface supports interchassis communication.



### Important

CLI commands must be executed on both chassis. Log onto both chassis before continuing. Always make configuration changes on the primary chassis first.

```
configure
context vpn_ctxt_name [-noconfirm]
 interface srp_if_name
 ip-address { ip_address | ip_address/mask }
 exit
exit
port ethernet slot_num/port_num
 description des_string
 medium { auto | speed { 10 | 100 | 1000 } duplex { full | half } }
 no shutdown
 bind interface srp_if_name srp_ctxt_name
end
```

## Configuring NACK Generation for SRP Checkpoint Messaging Failures

### Enabling NACK Messaging from the Standby Chassis

Transport (TCP) level re-transmission is supported on the SRP link between ICSR chassis. SRP configuration also supports optional application level checks to ensure checkpoints are received at the Standby chassis. Failed attempts to receive and apply checkpoints send NACK messages to the Active chassis.

When this feature is enabled and the standby chassis sends a NACK in response to the receipt of a micro-checkpoint (MC) that fails to be successfully applied, the standby chassis sends another NACK. The standby chassis will send more NACKs (configurable, default = 3) within a 10-minute window if a macro-checkpoint (FC) is not received. NACKs will continue to be sent and the 10-minute reset until an FC is received and applied, or the configured number of max-responses is reached.

You can also specify the number of times a NACK is sent within the 10-minute window in response to a failed MC or FC (Default = 3).

A **nack** keyword in the SRP Configuration mode **checkpoint session** command allows you to enable generation of NACK messages in response to checkpoint message failures on a Standby ICSR chassis.



#### Important

The **nack** keyword will only appear if a special ICSR optimization feature license has been purchased and installed. Contact your Cisco account representative for assistance.

```
configure
 context context_name
 service-redundancy-protocol variable
 checkpoint session nack { macro | micro } [max-response number]
 no checkpoint session nack { macro | micro }
 end
```

Notes:

- **max-response** is the number of times a NACK is sent within the 10-minute window in response to a failed MC or FC expressed as an integer from 0 through 65535 (Default = 3).

A **periodic-interval** keyword in the SRP Configuration mode **checkpoint session** command allows you to configure the interval between the sending of macro-checkpoints (FCs) between the active and standby chassis.



#### Important

The **periodic-interval** keyword will only appear if a special ICSR optimization feature license has been purchased and installed. Contact your Cisco account representative for assistance.

```
configure
 context context_name
 service-redundancy-protocol variable
 checkpoint session periodic-interval minutes
 default checkpoint session periodic-interval
 no checkpoint session periodic-interval
 end
```



## Selective Disabling of NACK Messaging

The NACK mechanism sends a NACK message for any ICSR checkpoint failure on the standby chassis. Every NACK sent from the standby chassis triggers a full checkpoint from the active chassis.

If the micro-checkpoint is failing continuously and sending NACKs, the active chassis keeps sending full-checkpoints. This increases SRP bandwidth.

CLI commands allow an operator to selectively disable and re-enable NACK messages for specific micro-checkpoints.

The Exec mode **srp disable nack micro-chkpt-cmd** disables the sending of a NACK from the standby chassis.

```
srp disable nack micro-chkpt-cmd chkpt_number
```

*chkpt\_number* specifies the checkpoint number to be disabled as an integer from 1 through 255. You can obtain checkpoint numbers (CMD IDs) from the output of the **show srp checkpoint info** command.

You can re-enable the micro-checkpoint using the **srp enable nack micro-chkpt-cmd** command.

```
srp enable nack micro-chkpt-cmd chkpt_number
```

## Configuring LZ4 Compression Algorithm

You can optionally enable LZ4 compression algorithm for SRP messaging payload. The zlib algorithm remains as the default.

LZ4 is a very fast lossless compression algorithm with near-linear scalability for multi-threaded applications.

The **compression** keyword in the SRP Configuration mode **checkpoint session** command allows you to enable the use of the LZ4 compression algorithm.



### Important

The **compression** keyword will only appear if a special ICSR optimization feature license has been purchased and installed. Contact your Cisco account representative for assistance.

The following command sequence enables the use of LZ4 compression:

```
configure
 context context_name
 service-redundancy-protocol
 checkpoint session compression lz4
 end
```

LZ4 compression is effective only if both chassis are configured with LZ4. If any one chassis has zlib (default) configured, the compression algorithm reverts to zlib. The algorithm is negotiated only during initial socket establishment. Once agreed no more negotiation takes place until the TCP socket connection is reset.

## Reducing Sync-Up Time with Standby ICSR Chassis

The default method for synchronizing the SRP database requires tens of seconds of delay whenever the TCP connection between the Active and Standby session managers is established. Once the TCP connection is established, heart beat messages are exchanged between both ICSR chassis every 3 seconds. The standby chassis waits for seven heart beat messages from the active chassis before it is ready to accept data. This may cause significant delay in session manager database synchronization on the standby chassis.

You can enable an aggressive method for synchronizing the session manager database reduces recovery time in the following scenarios:

- Standby Session Manager crash
- Packet processing card failure on Standby chassis
- Standby chassis reboot
- Temporary loss and recovery of SRP connection

The aggressive method reduces the number of heartbeat messages and amount of housekeeping information exchanged between ICSR chassis.

The SRP Configuration mode **standby database-recovery aggressive** command allows you to select normal or aggressive restoration of the SRP database.

The following command sequence enables the aggressive recovery mode:

```
configure
context context_name
 service-redundancy-protocol
 standby database-recovery aggressive
 end
```

The default form of this command restores the normal mode of SRP database recovery.

## Verifying SRP Configuration

Verify that your SRP contexts were created and configured properly by running the **show srp info** command (Exec Mode) on each chassis.

Notes:

- The interval is specified as an integer divisible by 15 in the range from 30 through 1440 (Default = 45 minutes). The interval range for sending full checkpoints is 30 minutes to 24 hours (1440 minutes).

## Modifying the Source Context for ICSR

To modify the source context of core service:

- 
- Step 1** Add the Border Gateway Protocol (BGP) router AS-path and configure the gateway IP address, neighbor IP address, remote IP address in the source context where the core network service is configured, by applying the example configuration in [Configuring BGP Router and Gateway Address, on page 382](#).
- Step 2** Configure the service redundancy context with the BGP neighbor context and IP address to monitor the BGP link activity by applying the example configuration in [Configuring the SRP Context for BGP, on page 383](#).
- Step 3** Verify your BGP context configuration by following the steps in [Verifying BGP Configuration, on page 383](#).
- Step 4** Save your configuration as described in [Verifying and Saving Your Configuration](#).
- 

## Configuring BGP Router and Gateway Address

Use the following example to create the BGP context and network addresses.

```

configure
context source_ctxt_name
router bgp AS_num
network gw_ip_address
neighbor neighbor_ip_address remote-as AS_num
end

```

Notes:

- *source\_ctxt\_name* is the context where the core network service is configured.

## Configuring the SRP Context for BGP

Use the following example to configure the BGP context and IP addresses in the SRP context.

```

configure
context srp_ctxt_name
service-redundancy-protocol
monitor bgp context source_ctxt_name neighbor_ip_address
end

```

*neighbor\_ip\_address* can be entered in IPv4 dotted-decimal or IPv6 colon-separated-hexadecimal notation. Multiple IP addresses can be added per context as IPv4 and/or IPv6 IP addresses.

An ICSR failover is triggered when all BGP peers within a context are down.

Optionally, you can configure SRP peer groups within a context. ICSR failover would then occur if all peers within a group fail. This option is useful in deployments in which a combination of IPv4 and IPv6 peers are spread across multiple paired VLANs, and IPv4 or IPv6 connectivity is lost by all members of a peer group.

A sample configuration for SRP peer groups within a context ("PGWin") appears below.

```

monitor bgp context PGWin 10.1.1.16 group 1
monitor bgp context PGWin 10.1.1.17 group 1
monitor bgp context PGWin 69.2.215.0 group 2
monitor bgp context PGWin 69.2.215.1 group 2
monitor bgp context PGWin 2001:4333:201:1102:103:2a1:: group 3
monitor bgp context PGWin 2001:4333:201:1102:103:2a1:0:1 group 3

```

In the above sample configuration, ICSR failover would occur if both addresses in group 1, 2 or 3 lost connectivity.

For additional information refer to the description of the **monitor bgp**, **monitor diameter** and **monitor authentication-probe** commands in the *Service Redundancy Protocol Configuration Mode Commands* chapter of the *Command Line Interface Reference*.

## Verifying BGP Configuration

Verify your BGP configuration by entering the **show srp monitor bgp** command (Exec Mode).

## Modifying the Destination Context for ICSR

To modify the destination context of core service:

- 
- Step 1** Add the BGP router and configure the gateway IP address, neighbor IP address, remote IP address in the destination context where the core network service is configured, by applying the example configuration in [Configuring BGP Router and Gateway Address in Destination Context](#), on page 384.
- Step 2** Configure the service redundancy context with BGP neighbor context and IP address to monitor the BGP link activity by applying the example configuration in [Configuring SRP Context for BGP for Destination Context](#), on page 384.
- Step 3** Set the subscriber mode to **default** by following the steps in [Setting Subscriber to Default Mode](#), on page 384.
- Step 4** Verify your BGP context configuration by following the steps in [Verifying BGP Configuration in Destination Context](#), on page 384.
- Step 5** Save your configuration as described in *Verifying and Saving Your Configuration*.
- 

## Configuring BGP Router and Gateway Address in Destination Context

Use the following example to create the BGP context and network addresses.

```
configure
context dest_ctxt_name
router bgp AS_num
network gw_ip_address
neighbor neighbor_ip_address remote-as AS_num
end
```

Notes:

- *AS\_num* is the autonomous systems path number for this BGP router.

## Configuring SRP Context for BGP for Destination Context

Use the following example to configure the BGP context and IP addresses in the SRP context.

```
configure
context srp_ctxt_name
service-redundancy-protocol
monitor bgp context dest_ctxt_name neighbor_ip_address
end
```

## Setting Subscriber to Default Mode

Use the following example to set the subscriber mode to **default**.

```
configure
context dest_ctxt_name
subscriber default
end
```

## Verifying BGP Configuration in Destination Context

Verify your BGP configuration by entering the **show srp monitor bgp** command (Exec Mode).

## Disabling Bulk Statistics Collection on a Standby System

You can disable the collection of bulk statistics from a system when it is in the standby mode of operation.



### Important

When this feature is enabled and a system transitions to standby state, any pending accumulated statistical data is transferred at the first opportunity. After that no additional statistics gathering takes place until the system comes out of standby state.

Use the following example to disable the bulk statistics collection on a standby system.

```
configure
bulkstat mode
no gather-on-standby
end
```

Repeat this procedure for both systems.

## Verifying the Primary and Backup Configuration

This section describes how to compare the ICSR configuration on the primary and backup systems.

**Step 1** Enter the **show configuration srp** command on each system (Exec mode).

**Step 2** Verify that both chassis have the same SRP configuration information.

The output looks similar to following:

```
config
context source
interface haservice loopback
ip address 172.17.1.1 255.255.255.255 srp-activate
#exit
radius attribute nas-ip-address address 172.17.1.1
radius server 192.168.83.2 encrypted key 01abd002c82b4a2c port 1812
radius accounting server 192.168.83.2 encrypted key 01abd002c82b4a2c port 1813
ha-service ha-pdsn
mn-ha-spi spi-number 256 encrypted secret 6c93f7960b726b6f6c93f7960b726b6f hash-algorithm md5
fa-ha-spi remote-address 192.168.82.0/24 spi-number 256 encrypted secret 1088bdd6817f64df
bind address 172.17.1.1
#exit
#exit
context destination
ip pool dynamic 172.18.0.0 255.255.0.0 public 0 srp-activate
ip pool static 172.19.0.0 255.255.240.0 static srp-activate
#exit
context srp
service-redundancy-protocol
#exit
#exit
```

## Configuring Subscriber State Management Audit Process

This audit is to ensure that two ICSR peers are in synch and identifies any discrepancies prior to any scheduled or unscheduled switchover events.

- 
- Step 1** Enter the SRP Context mode and enter the **service-redundancy-protocol** command.
- Step 2** Enter the **audit daily-start-time** command. Specify the daily start time as an hour and minute. For example, a start time of 06 00 indicates that the audit will begin at 6:00 AM.
- Step 3** Enter the **audit periodicity** command. Specify the interval in minutes for generating SRP audit statistics as an integer from 60 through 1440. For example, a periodicity of 90 indicates that SRP audit statistics will be generated every 90 minutes beginning at the specified start time. Default = 60.

A sample configuration sequence appears below.

```
config
context srp
 service-redundancy-protocol
 audit daily-start-time 06 00
 audit periodicity 90
end
```

---

## Troubleshooting ICSR Operation

### SSD

StarOS supports an ICSR-specific **show support details** (SSD) command that outputs the results from a series of Exec mode **show** commands. This mini SSD reduces capture time when debugging ICSR timing issues between the Active and Standby chassis, facilitating quicker resolution of the problem.

The **show support details icshr** command produces a mini SSD that contains the output of the following **show** commands:

- show srp info
- show srp checkpoint statistics
- show srp checkpoint statistics verbose
- show srp checkpoint statistics debug-info
- show srp checkpoint statistics sessmgr all
- show srp checkpoint statistics sessmgr all debug-info
- show srp checkpoint statistics ipsecmgr all
- show srp checkpoint statistics sessmgr all write-list-stats
- show srp checkpoint info
- show srp monitor
- show srp monitor all
- show srp monitor diameter debug
- show srp statistics
- show srp call-loss statistics

- show srp audit-statistics
- show session subsystem facility sessmgr all debug-info

The SSD output can be directed to a file that can be stored to **/flash** or off the chassis. For additional information, see the *Command Line Interface Reference*.

### show srp details

The Exec mode **show srp details** command displays comprehensive information used by TAC personnel to troubleshoot ICSR/SRP issues.

## Updating the Operating System

Updating the operating system (StarOS™) on an ICSR system is performed separately on each system while it is in standby mode. Traffic disruption is minimal since an active system will be handling call sessions while the standby system is being updated.

The general upgrade sequence is as follows:

1. Download the StarOS software image and copy/transfer it to both the active and standby system.
2. Save the currently running configurations on both systems.
3. Update the standby backup system first.
4. Initiate an SRP switchover from the active primary system to make the standby backup system active.
5. Update the standby primary system.
6. Initiate an SRP switchover from the active backup system to make the standby primary system active.

The four-part flowchart below shows a more complete view of all the procedures required to complete the StarOS upgrade process.



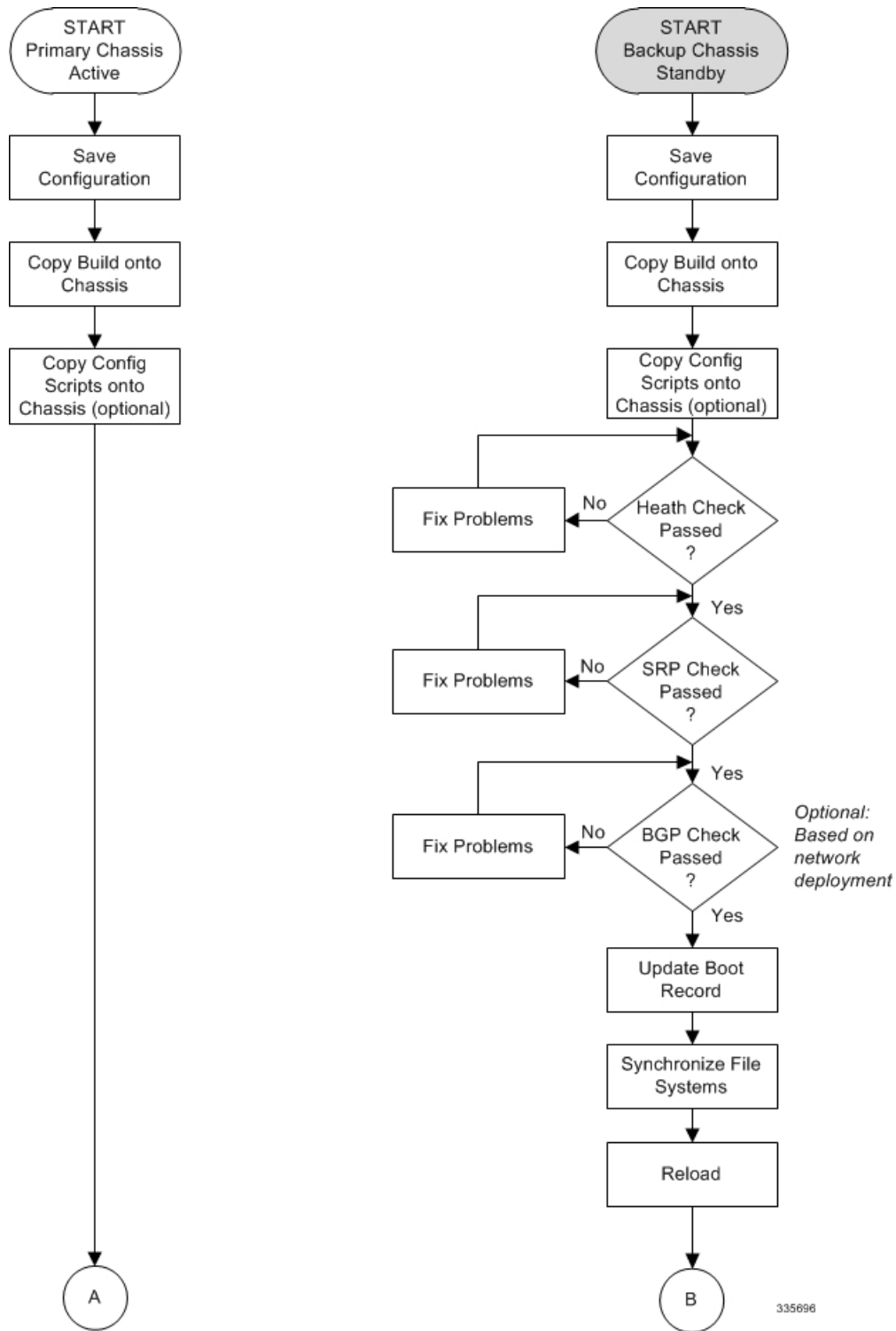
---

**Caution**

Enabling the Demux on MIO/UMIO/MIO2 feature changes resource allocations within the system. This directly impacts an upgrade or downgrade between StarOS versions in ICSR configurations. Contact Cisco TAC for procedural assistance prior to upgrading or downgrading your ICSR deployment.

---

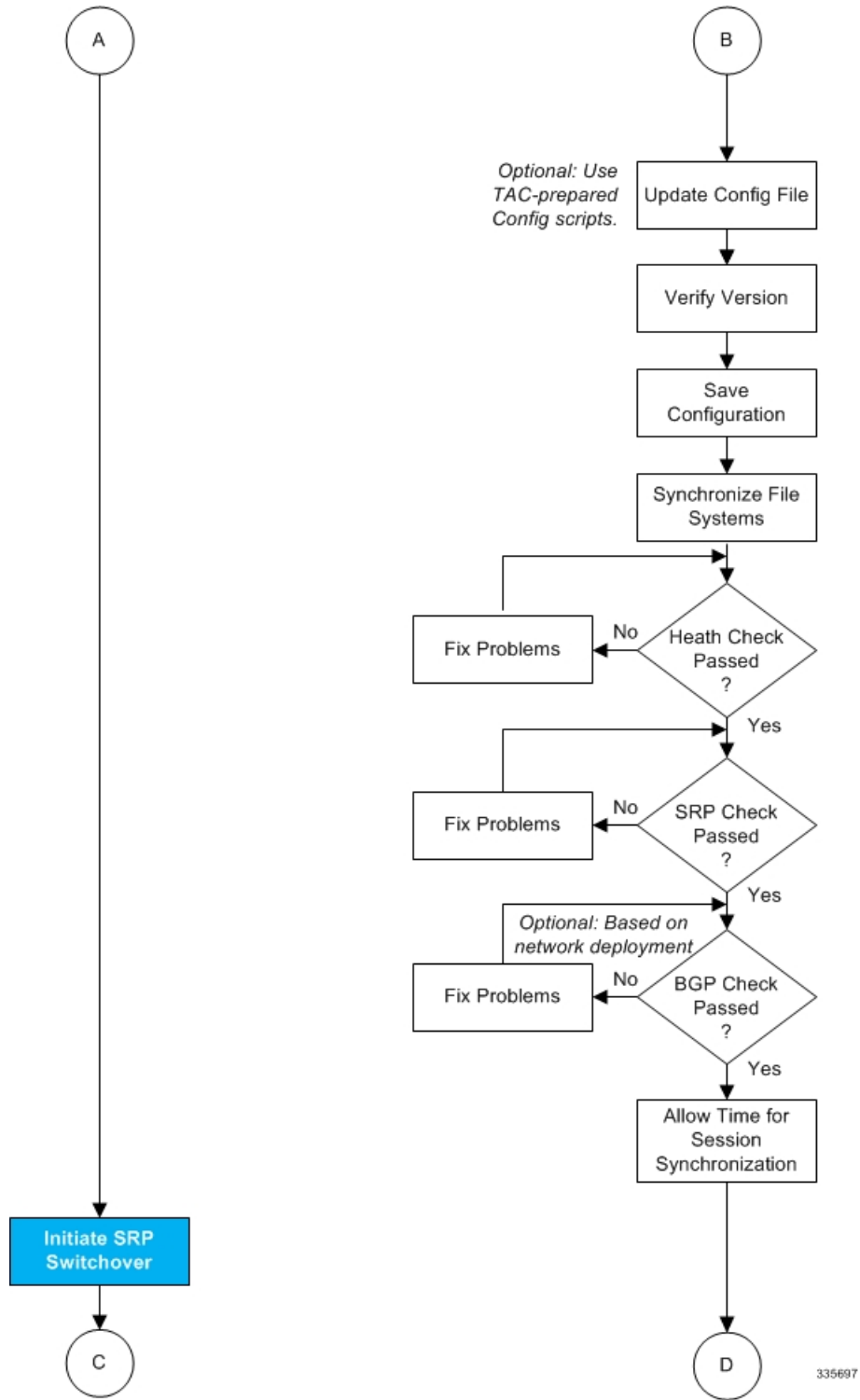
Figure 29: ICSR Software Upgrade – Part 1



335696

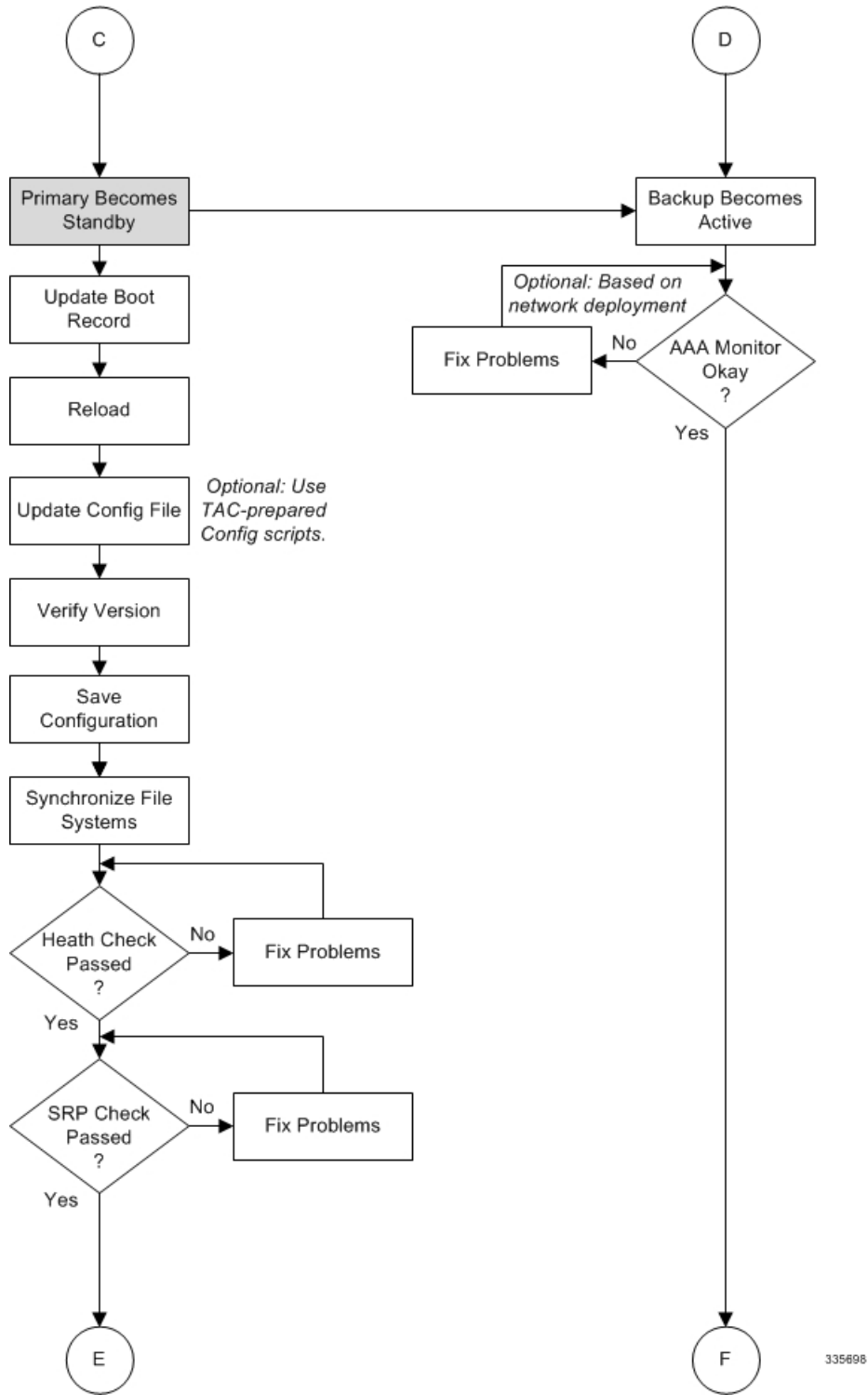


Figure 30: ICSR Software Upgrade – Part 2



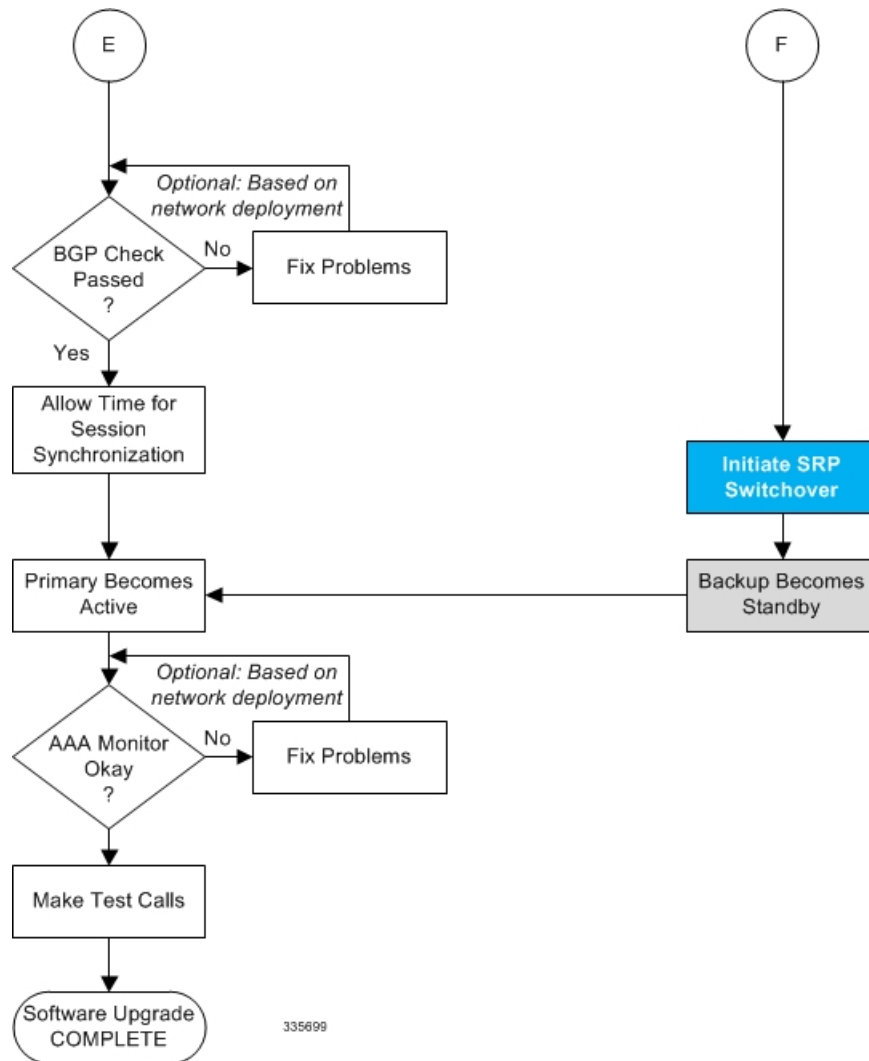
335697

Figure 31: ICSR Software Upgrade – Part 3



335698

Figure 32: ICSR Software Upgrade – Part 4



## Both ICSR Systems

Perform the tasks described below on both the primary (active) and backup (standby) ICSR systems.

### Downloading and Transferring the StarOS Image

- Step 1** Verify that there is enough free space on the **/flash** device to accommodate the new operating system image file by entering the following Exec mode command: `[local]host_name# directory /flash`
- Step 2** Access to the Cisco support site and download facility is username and password controlled. Download the software image to a network location or physical device (USB stick) from which it can be uploaded to the **/flash** device.
- Step 3** Transfer the new operating system image file to the **/flash** device on the MIO/UMIO/MIO2 using one of the following methods:
- Copy the file from a network location or local device plugged into the MIO/UMIO/MIO2 using the **copy** command.

```
[local]host_name# copy from_url to_url [-noconfirm]
```

- b) Transfer the file to the **/flash** device using an FTP client with access to the system. The FTP client must be configured to transfer the file using **binary** mode.
- c) Transfer the file to the **/flash** device using an SFTP client with access to the system.

In release 20.0 and higher Trusted StarOS builds, FTP is not supported.

- Step 4** Verify that the image file was successfully transferred to the **/flash** device by running the Exec mode the following command:

```
[local]host_name# directory /flash
```

- Step 5** Run the **show version /flash/image\_filename** command to verify the build information. Any CRC errors will be displayed in the output of this command. If any errors appear, check the build and re-transfer it onto the chassis. Confirm that the correct image version and build description is displayed

## Standby ICSR System

Perform the tasks described below on the backup or standby ICSR system.

### Performing Health Checks

Health checks are a series of Exec mode **show** commands to determine the readiness of the system to handle a software update.

- Step 1** Run **show card table all |grep unknown**. No output should be displayed.
- Step 2** Run **show card table |grep offline**. No output should be displayed.
- Step 3** Run **show resources |grep Status**. The output should display "Within acceptable limits".
- Step 4** Run **show alarm outstanding**. Review the output for any issues that may preclude performing the software update.

### Performing SRP Checks

Service Redundancy Protocol (SRP) checks verify that the mechanism for monitoring ICSR system status is operational.

- Step 1** Run **show srp monitor all**.
- Step 2** Review the output for any issues that may preclude performing the software update.

### Performing BGP Checks

Border Gateway Protocol (BGP) checks are only required when BGP is used to support redundant interchassis communication. These checks are run per context and per service type.

- 
- Step 1** For each BGP-enabled context, run **show ip bgp summary**. Verify that the BGP peers are connected and that IPv4 and IPv6 peers are up. Repeat for all BGP-enabled contexts.
- Step 2** Run **show service\_name all |grep "Service Status:"**. The service should be "Started". Repeat for all services running on the chassis.
- 

## Updating the Boot Record

You must add a new boot stack entry for the recently downloaded software image (.bin) file.

- 
- Step 1** Run the Exec mode **show boot** command to verify that there are less than 10 entries in the boot.sys file and that a higher priority entry is available (minimally there is no priority 1 entry in the boot stack).
- Step 2** Create a new boot stack entry for the new file group, consisting of the new operating system image file and the currently used CLI configuration file by entering the following Global Configuration command:

```
[local]host_name(config)# boot system priority number image image_url /flash/filename config
cfg_url /flash/filename
```

- Step 3** Assign the next highest priority to this entry, by using the <N-1> method, wherein you assign a priority number that is one number less than your current highest priority.
- If priority 1 is in use, you must renumber the existing entries to ensure that at least that priority is available.
- The maximum number of boot stack entries that can be contained in the boot.sys file is 10. If there are already 10 entries in the boot stack, you must delete at least one of these entries (typically, the lowest priority) and, if necessary, renumber some or all of the other entries before proceeding. Use the **no boot system priority** command to delete a boot stack entry.
- For information on using the **boot system priority** command, refer to the *Adding a New Boot Stack Entry* section in this guide
- 

## Synchronizing File Systems

Synchronize the local file systems by entering the following Exec mode command:

```
[local]host_name# filesystem synchronize all
```

## Reboot StarOS

Reboot the StarOS by entering the following command:

```
[local]host_name# reload [-noconfirm]
```

As the system reboots, it loads the new operating system software image and its corresponding CLI configuration file using the new boot stack entry configured earlier.

After the system reboots, establish a CLI session and enter the **show version** command to verify that the active software version is correct.

*Optional for PDSN:* If you are using the IP Pool Sharing Protocol during your upgrade, refer to *Configuring IPSP Before the Software Upgrade* in the *PDSN Administration Guide*.

## Updating the Configuration File

Features in the new operating system may require changes to the configuration file. These changes can be done manually or facilitated by custom scripts prepared by Cisco TAC. Make whatever changes are necessary prior to saving the updated configuration file.

## Verifying the Software Version

After the system has successfully booted, verify that the new StarOS version is running by executing the Exec mode **show version** command.

You can run the Exec mode **show build** command to display additional information about the StarOS build release.

## Saving the Configuration File

Use the Exec mode save configuration command to save the currently running configuration to the **/flash** device and to an off-chassis location (external memory device or network URL). The off-chassis copy assures that you will have a fallback, loadable configuration file should a problem be encountered.

## Completing the Update Process

Repeat the following tasks to complete the upgrade process on the standby secondary chassis:

- [Synchronizing File Systems, on page 393](#)
- [Performing Health Checks, on page 392](#)
- [Performing SRP Checks, on page 392](#)
- [Performing BGP Checks, on page 392](#)

## Waiting for Session Synchronization

Allow time for session synchronization to occur between the ICSR chassis before proceeding to the next steps.

- 
- Step 1** Run the **show session recovery status verbose** command on both chassis. Proceed to the next steps only when no errors are seen in the output of this command.
- Step 2** On the standby chassis, run **show srp checkpoint statistics |more**.
- Step 3** On active chassis, run **show subs summary |grep Total**.
- Step 4** Compare the number of subscribers on the active chassis and the number of Current pre-allocated calls: on the standby chassis. They should be similar (within 5%). Allow a few minutes for systems to complete synchronization.
- 

## Primary System

Perform the tasks described below on the primary (active) ICSR system.

## Initiating an SRP Switchover

An SRP switchover places the primary chassis in standby mode and makes the backup chassis active. The secondary chassis is now processing sessions with the upgraded software.

- 
- Step 1** On the primary chassis run the **srp initiate-switchover** command. All existing sessions will be migrated to the backup chassis and it begins servicing new session requests. Allow the switchover process to complete.
- Step 2** On the primary chassis, run the **show srp info** command. Chassis State should indicate Standby when switchover is complete.
- Step 3** On the backup chassis, confirm the switchover is complete by running the **show srp info** command. Chassis State should indicate Active when switchover is complete.
- 

## Checking AAA Monitor Status on the Newly Active System

If your network deployment requires communication with AAA servers, log into the newly active system and perform an AAA monitor check. You will be checking for the existence of any SNMP traps that indicate the system cannot communicate with AAA servers (**starSRPAAAUnreachable**).

- 
- Step 1** Run the Exec mode command **show snmp trap history |grep starSRPAAAUnreachable**.
- Step 2** There should be no output for this command, or no very recent SNMP trap notifications (based on the event timestamp).
- Step 3** If the active system cannot communicate with one or more AAA servers, refer to [AAA Monitor](#) for additional information.
- 

## Completing the Software Update

Log into the backup (standby) system and repeat the following tasks to complete the upgrade process on the backup (standby) system:

- [Updating the Boot Record, on page 393](#)
- [Reboot StarOS, on page 393](#)
- [Updating the Configuration File, on page 394](#)
- [Verifying the Software Version, on page 394](#)
- [Saving the Configuration File, on page 394](#)
- [Synchronizing File Systems, on page 393](#)
- [Performing Health Checks, on page 392](#)
- [Performing SRP Checks, on page 392](#)
- [Performing BGP Checks, on page 392](#)
- [Waiting for Session Synchronization, on page 394](#)

## Initiating an SRP Switchover

This SRP switchover places the primary system in active mode and returns the backup system to the standby. The primary chassis is now processing sessions with the upgraded software.

- 
- Step 1** On the backup chassis run the **srp initiate-switchover** command. All existing sessions will be migrated to the primary chassis which begins servicing new session requests. Allow the switchover process to complete.
- Step 2** On the backup system, run the **show srp info** command. Chassis State should indicate Standby when switchover is complete.

- Step 3** On the primary system, confirm the switchover is complete by running the **show srp info** command. Chassis State should indicate Active when switchover is complete.
- 

## Making Test Calls

Once the chassis state is verified and subscribers are migrated, perform new call testing to make sure calls are successful.

## Fallback Procedure

To revert to the previous configuration and software build, perform the following steps as a user with administrative privileges.

---

- Step 1** Run the Exec mode **show boot** command. The topmost lowest numbered entry of the displayed output should be the new configuration with the new software build. The second topmost entry should be the backup configuration.

- Step 2** Remove the topmost boot entry n, and synchronize the configuration across the management cards.

```
[local]host_name# config
[local]host_name(config)# no boot system priority n
[local]host_name(config)# end
[local]host_name# filesystem synchronize all
```

- Step 3** Reboot the system to load its previous configuration.

```
[local]host_name# reload
```

- Step 4** Perform health checks as described in [Performing Health Checks, on page 392](#)
-





## CHAPTER 27

# Support Data Collector

---

The Support Data Collector (SDC) is a system feature that allows scheduled collection of process state, counter, event and attribute data that may be useful when troubleshooting problems at an installation site.

This chapter includes the following sections:

- [Overview, on page 397](#)
- [Configuring SDR Collection, on page 398](#)
- [Displaying the SDR Collection Configuration, on page 398](#)
- [Collecting and Storing the SDR Information, on page 399](#)
- [Managing Record Collection, on page 399](#)
- [Using SDRs to Diagnose Problems, on page 401](#)
- [SDR CLI Commands, on page 401](#)

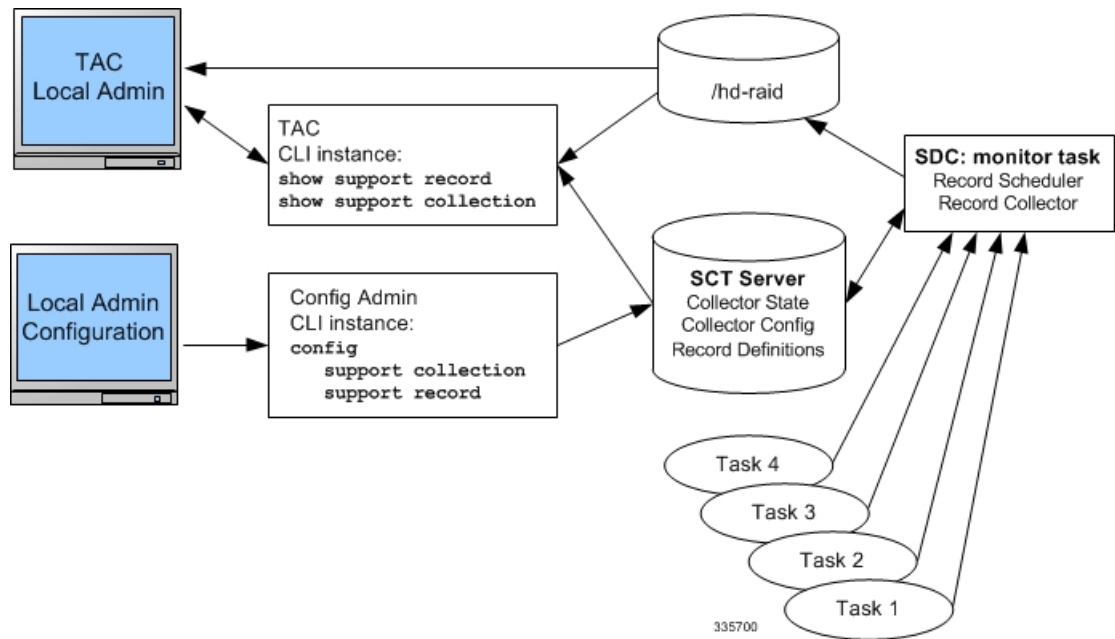
## Overview

The task of collecting the support data is performed by a background CLI task called the record collector. The administrator configures the SDC via the CLI with the commands to be executed on a periodic basis. The record collector always runs in the background and checks if there are records to be collected.

When it is time to collect support data, the scheduler executes the configured sequence of CLI commands and stores the results in a gunzipped (.gz) file on the hard-disk. This file is called an SDR (Support Data Record), and represents a snapshot of the overall state of the system at that time.

Technical Assistance Center (TAC) personnel and local administrators can review the SDRs on-line or by transferring them off the system. They may also wish to investigate the collector state information. The figure below shows system tasks that contain state and counter information. Arrows between tasks and processes represent messenger requests and indicate the predominant flow of data.

Figure 33: SDC Tasks and Processes&lt;



## Configuring SDR Collection

The Support Data Record (SDR) is an ordered set of the CLI support commands' display output that is stored in a stand-alone compressed file. Each CLI support command output is stored in its own record section. The record section is identified by a record section name and its ASCII command syntax. For example, the record section `show_version` would have a CLI command string of "show version".

The order in which the record section commands appear in the configuration is significant. All of the support record section commands must be configured together as an ordered set. In other words, just specifying one command by itself will result in just that one command output constituting the contents of the entire SDR.

The user may configure a specific set of record sections for the SDR which may or may not include some or all of the default SDR record sections. This configuration is stored in the Global Configuration section of the configuration file. Refer to [Configuration Commands \(Global Configuration Mode\)](#), on page 402 for more detail on the **support record section** command.

## Displaying the SDR Collection Configuration

The **show configuration verbose** command displays the default support record sections, if the user has not specified any support record sections. If the user has configured support record sections, then the **show configuration** command displays user-configured support record sections. The support collection schedule configuration also appears in the **show configuration** output under the Global Configuration section.

## Collecting and Storing the SDR Information

At the scheduled time, the Support Data Collector (SDC), if active, runs in the background to collect all the record section commands that have been specified. This information is concatenated as one contiguous output. The output is compressed and stored as a file on disk in the `/hd-raid/support/record/` directory.

The periodicity of the SDC is configured by the **support collection schedule** command under Global Configuration Mode. Once the SDR is stored, the SDC waits the sleep-duration interval specified via the **support collection** command before collecting another SDR.



---

**Important**

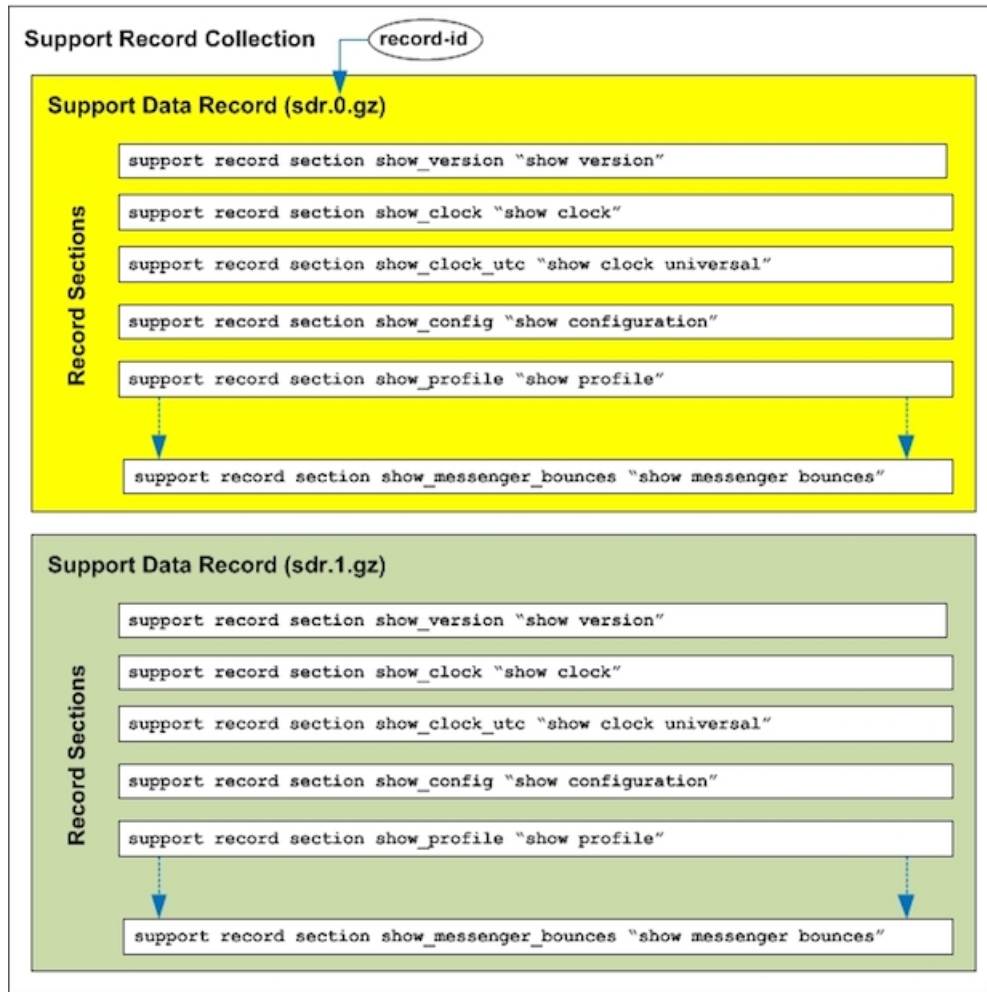
The period between SDRs is equal to the configured sleep-duration interval + the time taken to collect the previous record.

---

## Managing Record Collection

The SDRs are stored together in a self-relative set. This self-relative set is called a Support Record Collection. Each individual SDR is identified with a record-id. The record-id of the most recent SDR is always 0 (zero). The next older SDR is record-id 1, and so on, for the number of records in the stored collection. For example, if there are five SDRs, they are identified as SDR-0 through SDR-4.

Figure 34: Support Data Collection Hierarchy



When a new SDR is created, the numbers all increment by one and the newest SDR is given the value of 0. If the total number of records exceeds a configured maximum, then the oldest SDR is deleted.

Using the example above, when the maximum SDR count of 5 is reached, the SDRs continue to be SDR-0 through SDR-4, with the file timestamps indicating that the files are changing over time.

The time interval between collections may vary by several minutes in relation to the specified sleep-duration. This is because the interval specifies the idle time between scheduled collection runs. Since the actual overhead of the collecting process is not included in the scheduled intervals, the time differences between collections includes this non-deterministic amount of time.



**Important**

Using a shorter interval to compensate for this behavior is not recommended, since it will only add to the overhead incurred by the collection process and will ultimately impact the overall system performance. The sleep-duration (idle-time) between scheduled collections is an important component of the "self-throttling" mechanism that should not be circumvented by the user.

The Exec Mode **show support collection** command displays useful information about the Support Data Collector. The output includes information about when the collector last ran, how long it took to run, when it is scheduled to run again, as well as the number of SDRs currently stored, where they are stored, and how much storage space is being used. Refer to [Exec Mode Commands, on page 403](#) for more detail about this command.

## Using SDRs to Diagnose Problems

The user can compare the SDRs by examining two or more in sequence. These SDRs are dumped out in their CLI-formatted output display. Comparing the display outputs reveals trends and performance or configuration differences that indicate problem areas.

Once specific record sections have been identified as having problematic characteristics, only the CLI **show** commands associated with those sections need be monitored and compared to further isolate the problem areas. In addition, individual SDRs may be transferred via system-supported protocols to remote system, or the current collection may be transferred as a set for later analysis.

## SDR CLI Commands

You may use the collected support data records to view support data chronologically. If the default list and sequence of sections is inadequate for system monitoring, you can configure your own set of record section commands that make up a particular support record.



---

**Important**

Refer to the *SDR CLI Command Strings* appendix for a listing of supported CLI strings (**show** commands) for record sections. The listing also identifies the CLI strings supported as default record sections. You can obtain the same listing by running the **show support collection definitions** command.

---



---

**Important**

You may enter up to 200 SDR CLI strings in a single record section command. If you attempt to add more than 200 CLI strings, an error message appears. You may also receive an error message if the system is unable to parse all of the requested CLI strings because they are too complicated to parse.

---

After configuring the SDR you then configure the sleep-duration interval between record collections and the number of historical records to be retained before being overwritten. By default, configuring this collection information makes the collector mechanism active (if not already active).

After one or more collection intervals have passed, the SDR data becomes available for analysis. The administrator can then use CLI commands to examine the SDR information to perform root cause analysis and trend analysis based on how the data has changed over time. The administrator may decide to transfer the SDRs off the system to be analyzed remotely, for example, by Cisco TAC.

For complete descriptions of the CLI commands discussed below, refer to the *Command Line Interface Reference*.

## Configuration Commands (Global Configuration Mode)

### support record

```
support record section section-name command "command-string" [section section-name
command "command-string"] ...
```

```
no support record [all | section section_name]
```

```
default support record [all | section section_name]
```

The **support record section** command configures a specific record section or set of record sections for a support information output command. The order in which record sections are saved is fixed, regardless of the sequence in which the CLI commands were entered.

For example:

```
[local]host_name(config)# support record section show_context command "show
context"
```

If the **support record section** command is not explicitly configured by the user, a default set of record section commands are used. These default record section commands are displayed when you run the **show configuration verbose** command. If support record section commands are explicitly configured, they replace the default commands.



#### Important

Refer to the *SDR CLI Command Strings* appendix for a listing of supported CLI strings (**show** commands) for record sections. The listing also identifies the CLI strings included in default record sections.

The **no support record** command removes either a specific section of the record definition or all of the sections. If you specify the **default support record** command, the default record section definition of that specified record section is used. If neither the keyword **all** or **section** is specified, all the record section definitions are removed.

### support collection

```
support collection [sleep-duration [hours h | minutes m]] [max-records
n]
```

```
no support collection
```

```
default support collection
```

The **support collection** command modifies and/or enables the support collection process. If support collection has been previously disabled, this command enables the collection activity. If the support collection is currently enabled, this command may be used to modify the sleep-duration interval and/or the maximum number of SDRs that can be collected and stored.

The **sleep duration** keyword specifies the time interval between the collection of support data. It can be specified in hours or minutes with a default of one hour (60 minutes).

The **max-records** keyword specifies the number of SDRs to store as an integer from 1 to 65535. When this value is exceeded, the new SDR overwrites the oldest SDR. The default value is 168.



**Important** SDR files will be stored in the `/hd-raid/support/records/` directory.

For example:

```
[local]host_name(config)# support collection sleep-duration minute 30
max-records 50
```

Use the **no support collection** command to explicitly disable the collection of the SDRs. If no record section commands are defined, the support data collector mechanism is also effectively disabled.

Use the **default support collection** command to enable the support data collector using the default record sections.

## Exec Mode Commands

### show support record

```
show support record record-id [to record-id] [section section_name]
```

The **show support record** command displays a collection of SDRs. The SDRs are displayed in order from lowest record-id to highest record-id.

Each SDR is identified by a time index called the record-id. For example, the most recent record is always record-id 0 (filename = sdr.0.gz). The next older record is record-id 1 (filename = sdr.1.gz), and so on.

When a new record is collected it is given a record-id of 0. The previously most recent record is renamed to record-id 1, and so on. The display includes the record-id along with the collection time-stamp.

The *record-id* variable identifies a single SDR. The **to** keyword specifies the endpoint record-id when displaying a range of SDRs.

The **section** keyword displays a particular section of the record.

### delete support record

```
delete support record record-id [to record-id]
```

The **delete support records** command removes an SDR with a specified record-id or all SDRs in the specified range of record-ids.

### show support collection

```
show support collection [definitions]
```

The **show support collection** command displays information on SDC activity. It displays information such as the start time of the last scheduled collection, the duration of the last scheduled collection, whether the collection is still in progress, etc. In addition this command lists the currently stored set of SDR record-ids, their respective timestamps, and size of each SDR.

```
[local]host_name# show support collection
Record Collection Enabled : yes
Last Collection Start Time : Monday October 21 06:29:05 PDT 2013
Last Collection End Time : Monday October 21 06:29:09 PDT 2013
Est. Collection Next Start : Monday October 21 07:29:13 PDT 2013 (40 minutes)
```

```
Support Data Records at /var/tmp/support-records/
 ID Name Size Date/Time
 167 sdr.167.gz 42863 Monday October 21 04:40:00 PDT 2013
 166 sdr.166.gz 170425 Monday October 21 05:40:08 PDT 2013
total SDRs 2, total bytes 2132880, time span is last 1 day(s) 1 hour(s)
```

The optional **definitions** keyword displays the list of default support record section definitions. This is the list of all valid record section definitions. The display also indicates whether the record section is enabled or disabled by default.

```
[local]host_name# show support collection definitions
```

The output of this command reflects the sequence in which record sections will be output, regardless of the sequence in which they may have been entered by the user. Refer to the *SDR CLI Command Strings* appendix for additional information.





## APPENDIX **A**

# Engineering Rules

---

This appendix provides engineering guidelines for configuring the system to meet network deployment requirements.

- [CLI Session Rules, on page 405](#)
- [ASR 5500 Interface and Port Rules, on page 405](#)
- [Context Rules, on page 406](#)
- [Subscriber Rules, on page 409](#)
- [Service Rules, on page 410](#)
- [Access Control List \(ACL\) Engineering Rules, on page 410](#)
- [ECMP Groups, on page 411](#)
- [VPN Scaling Requirements, on page 411](#)

## CLI Session Rules

Multiple CLI session support is based on the amount of available memory. The internal Resource Manager reserves enough resources to support a minimum of six CLI sessions at all times. One of the six sessions is further reserved for use exclusively by a CLI session on the serial interface.

Additional CLI sessions beyond the pre-reserved limit are permitted if sufficient resources are available. If the Resource Manager is unable to reserve resources for a CLI session beyond those that are pre-reserved, users with administrator-privileges are prompted to create the new CLI session, even without reserved resources.

## ASR 5500 Interface and Port Rules

The rules discussed in this section pertain to the Ethernet ports used for subscriber traffic on the MIO/UMIO/MIO2 card (ports 10 through 29).

- Give all logical interfaces a unique name to identify the interface from others in the same context. Logical interfaces in different contexts may have the same name.
- A single physical port can support multiple logical interfaces when you configure VLAN tags for that physical port. You can use VLAN tagging to bind a single physical port to multiple logical interfaces that reside in different contexts.
- Assign all logical interfaces a valid IP address and subnet.

- Give each logical interface within a context a unique IP address(es). Logical interfaces in different contexts can have the same IP address(es).
- If multi-homing is supported on the network, you can assign all logical interfaces a single primary IP address and up to 16 secondary IP addresses.
- You can configure a logical interface in only one context, but you can configure multiple interfaces (up to 512) in a single context.
- You can apply a maximum of 256 access control list (ACL) rules to a single logical interface.
- All ports are identified by their <slot#>/<port#>.
- Each physical port for subscriber traffic on an MIO/UMIO/MIO2 card may contain up to a maximum of 1,024 VLAN tags.
- A logical interface is limited to using a single VLAN on a single physical port, identified by its <card#/slot#/port#>.

## Packet Data Network (PDN) Interface Rules

The following engineering rules apply to the interface to the packet data network (PDN):

- Configure the logical interfaces used to facilitate the PDN interface within the egress context.
- The default is to use a single interface within the egress context to facilitate the PDN interface.
- You can configure multiple interfaces in the egress context by using static routes or dynamic routing protocols.
- You may also configure next-hop default gateways.

## Context Rules

- A maximum of 63 contexts may be configured per chassis. Enabling demux functions on an MIO card reduces the maximum number of contexts to 10.
- Interfaces per Context
  - *Prior to Release 15.0:* Up to 16 interfaces can be configured within a single context.
  - *For Release 15.0 and higher:* With the Demux MIO/UMIO/MIO2 feature enabled, up to 64 interfaces can be configured within a single context.
  - 512 Ethernet+PPP+tunnel interfaces
  - 32 ipv6ip tunnel interfaces
  - 511 GRE tunnels (2,048 GRE tunnels per chassis)
  - 256 loopback interfaces
- IP Addresses and IP Address Pools
  - Up to 2,000 IPv4 address pools can be configured within a single context.

- *Prior to Release 15.0:* Up to 32 IPv6 pools can be configured within a single context.
- *For Release 15.0 and higher:* Up to 256 IPv6 pools can be configured within a single context.
- Up to a combined total of 5,000 IPv4 and IPv6 addresses can be configured per chassis.
- Each context supports up to 32,000,000 static IP pool addresses. You can configure a maximum total of 96,000,000 static IP pool addresses per chassis. Each static IP pool can contain up to 500,000 addresses.
- Each context supports up to 16,000,000 dynamic IP pool addresses. You can configure a maximum total of 32,000,000 dynamic IP pool addresses per chassis. Each dynamic IP pool can contain up to 500,000 addresses.




---

**Important** The actual number of IP Pools supported per context and chassis depends on how many addresses are being used and how they are subnetted.

---




---

**Important** Each address in the pool requires approximately 60 bytes of memory. The amount of memory required, however, depends on a number of factors such as the pool type, and hold-timer usage. Therefore, in order to conserve available memory, you may need to limit the number of pools depending on the number of addresses to be configured and the number of installed application cards.

---

- The maximum number of simultaneous subscriber sessions is controlled by the installed capacity license for the service(s) supported.
- The maximum number of static address resolution protocol (ARP) entries per context is 128.
- The maximum number of domains per context is 2,048.
- ASN-GW services configured within the same context cannot communicate with each other.
- Routes
  - Up to 1,200 static routes per context (48,000 per chassis).
  - 6,000 pool routes per context (6,000 per chassis)
  - *Releases prior to 18.5:* 5,000 pool explicit host routes per context (6,000 per chassis)
  - *Release 18.5 and higher:* 24,000 pool explicit host routes per context (24,000 per chassis)
  - 64 route maps per context
- BGP
  - *Releases 12 and 14:* 16,000 BGP prefixes can be learned/advertised per context (64,000 per chassis)
  - *Releases 15 and 16:* 32,000 BGP prefixes can be learned/advertised per context (64,000 per chassis)
  - *Releases 17, 18 and higher:* 64,000 BGP prefixes can be learned/advertised per context (64,000 per chassis)

- 64 EBGP peers can be configured per context (512 per chassis)
- 16 IBGP peers per context
- 512 BGP/AAA monitors per context in support of Interchassis Session Recovery (ICSR)
- OSPF
  - 200 OSPF neighbors per chassis
  - 10,000 OSPF routes per context (64,000 per chassis)
- MPLS
  - From Release 19.x to Release 21.6*
    - 16 label distribution protocol (LDP) sessions per context
    - Up to 8,000 incoming label map (ILM) entries per context (48,000 per chassis)
    - Combine Table size of 128,000 next hop label forwarding entries (NHLFE) and 64,000 prefixes that could potentially yield:
      - 1,000 forwarding equivalence class (FEC) entries per context (4,000 per chassis) - with 32 paths
      - 2,000 forwarding equivalence class (FEC) entries per context (8,000 per chassis) - with 16 paths
      - 16,000 forwarding equivalence class (FEC) entries per context (64,000 per chassis) - with 2 paths
      - 64,000 forwarding equivalence class (FEC) entries per context (64k per chassis) - with 1 path
  - Release 21.7 and higher*
    - 16 label distribution protocol (LDP) sessions per context
    - Up to 8,000 incoming label map (ILM) entries per context (48,000 per chassis)
    - Combine Table size of 256,000 next hop label forwarding entries (NHLFE) and 64,000 prefixes that could potentially yield:
      - 1,000 forwarding equivalence class (FEC) entries per context (4,000 per chassis) - with 64 paths
      - 2,000 forwarding equivalence class (FEC) entries per context (8,000 per chassis) - with 32 paths
      - 32,000 forwarding equivalence class (FEC) entries per context (64,000 per chassis) - with 2 paths
      - 64,000 forwarding equivalence class (FEC) entries per context (64,000 per chassis) - with 1 path
- VRF

- *Prior to Release 15.0:* 250 virtual routing and forwarding (VRF) tables per context (1,024 or 2,048 [release 14.0+] VRFs per chassis)
- *Release 15.0 and higher:* 300 virtual routing and forwarding (VRF) tables per context (2,048 VRFs per chassis) [256 VRFs per context with demux functions enabled on the MIO card]
- APN limit is 2,048 per chassis; VRF limits and APN limits should be identical.
- 64,000 IP routes
- NEMO (Network Mobility)
  - *Prior to Release 15.0:* 256K prefixes/framed routes per chassis and up to 8 dynamically learned prefixes per MR (Mobile Router)
  - *Release 15.0 and higher:* 512K prefixes/framed routes per chassis and up to 16 dynamically learned prefixes per MR (Mobile Router)
- 128 AAA servers per context for a default AAA server group. The servers can be configured as accounting, authentication, charging servers, or any combination thereof.
- You can configure up to 800 AAA server groups per context with following limitations:
  - 128 servers per AAA server group (accounting, authentication, charging server, or any combination thereof)
  - 1,600 servers per context in AAA Server group mode (accounting, authentication, charging server, or any combination thereof)
  - 800 NAS-IP address/NAS identifier (one primary and one secondary per server group) per context
- Up to 12 charging gateway functions (CGFs) for GTPP accounting can be configured per context.
- Up to 16 bidirectional forwarding detection (BFD) sessions per context (64 per chassis)

**Important**

Refer to *Engineering Rules* in your product administration guide for additional information on product-specific operating limits.

## Subscriber Rules

The following engineering rules apply to subscribers configured within the system:

- Configure a maximum of 2,048 local subscribers per context.
- You may configure attributes for each local subscriber.
- The system creates a default subscriber for each context when the context is made. Configure attributes for each default subscriber. If a AAA-based subscriber is missing attributes in the authentication reply message, the default subscriber attributes in the context where the subscriber was authenticated are used.



---

**Important** Default is not used when local authentication (for local subscribers) is performed.

---

- Configure default subscriber templates on a per AAA realm (domain aliases configured within a context) basis.
- Configure default subscriber templates on a per PDSN, FA, ASN-GW, or HA service.
- For AAA authenticated subscribers, the selection of local subscriber template to use for setting attributes is in the following order:
  - If the username (NAI) matches any local domain name and the domain name has a local subscriber name configured, that local subscriber template is used.
  - If the first case fails, and if the serving service has a default username configured, that subscriber template is used.
  - If the first two cases fail, the default subscriber template in the AAA context is used.

## Service Rules

The following engineering rules apply to services configured within the system:

- Configure a maximum of 256 services (regardless of type) per system.



---

**Caution** Large numbers of services greatly increase the complexity of management and may affect overall system performance. Therefore, you should not configure a large number of services unless your application absolutely requires it. Please contact your Cisco service representative for more information.

---

- The total number of entries per table and per chassis is limited to 256.
- Although you can use service names that are identical to those configured in different contexts on the same system, this is not a good practice. Services with the same name can lead to confusion and difficulty in troubleshooting problems, and make it difficult to understand the output of **show** commands.

## Access Control List (ACL) Engineering Rules

The following rules apply to Access Control Lists:

- The maximum number of rules per ACL is 128.
- The maximum number of ACL rules applied per port is 128.
- The maximum number of ACL rules applied per context is 1,024.
- The maximum number of ACL rules per IPSec policy is 1.
- The maximum number of IPSec ACL rules per context is 1,024.

- The maximum number of IPsec ACL rules per crypto map is 8.
- The maximum number of ACLs you can configure per context is limited by the number of rules allowed within each ACL. If each ACL contained the maximum number of rules (128), the maximum number of ACLs per context is 8 (128 X 8 ACLs = 1,024 ACL rules per context).
- The maximum number of ACLs applied to an IP access group is 1, whether it is configured for a port or context. Since the maximum number of IP access groups you can apply to an interface or context is 16, the following calculations apply:
  - For each interface/port: 8 rules per ACL multiplied by 16 IP access groups = 128 (the ACL rules limit per port)
  - For each context: 64 rules per ACL multiplied by 16 IP access groups = 1,024 (the ACL rules limit per context)

## ECMP Groups

The maximum number of Equal Cost Multiple Path (ECMP) groups are as follows:

- *For releases prior to 17.0*, StarOS supports a maximum of 512 groups.
- *For release 17.0 and higher*, StarOS supports a maximum of 2048 groups.




---

### Note

- *max\_num* is an integer from 1 through 10 (*releases prior to 18.2*)

*Release 18.2x*

- QVPC-DI: 32
- QVPC-SI: 32

*Release 21.4x*

- QVPC-DI: 64
- QVPC-SI: 64
- ASR 5500: 24

- Save your configuration as described in the [Verifying and Saving Your Configuration, on page 101](#) chapter.
- 

- *For release 20.0 and higher*, StarOS supports a maximum of 64000 groups.

## VPN Scaling Requirements

The following VPN scaling numbers are supported for specific releases.

Parameter	Scaling Number (Release 12.x, 14.x)	Scaling Number (Release 15.x, 16.x)	Scaling Number (Release 17.x, 18.x, 19.x, 20.x +)
BFD Sessions	16 per context 64 per chassis	16 per context 64 per chassis	16 per context 64 per chassis
Context level ACLs	256 per context	256 per context	256 per context
Dynamic pool addresses	16 million per context 32 million per chassis	16 million per context 32 million per chassis	16 million per context 32 million per chassis
IPv4 pools per context	2000 per context 5000 per chassis (combined IPv4 and IPv6)	2000 per context 5000 per chassis (combined IPv4 and IPv6)	2000 per context 5000 per chassis (combined IPv4 and IPv6)
IPv6 pools per context	32 per context 5000 per chassis (combined IPv4 and IPv6)	256 per context 5000 per chassis (combined IPv4 and IPv6)	256 per context 5000 per chassis (combined IPv4 and IPv6)
Number of BGP prefixes	16,000 per context 64,000 per chassis.	32,000 per context 64,000 per chassis.	64,000 per context 64,000 per chassis.
Number of contexts	63 (though PSC migrations do not work well beyond 32 contexts)	63 (though PSC migrations do not work well beyond 32 contexts)  Note the information about "Demux on MIO Cards" at the end of this section.	63 (though PSC migrations do not work well beyond 32 contexts)  Note the information about "Demux on MIO Cards" at the end of this section.
Number of dynamically learned prefixes per MR	8	16	16
Number of EBGP peers	64 per context 512 per chassis	64 per context 512 per chassis	64 per context 512 per chassis
Number of FEC entries	8000 labels per context 48,000 per chassis	8000 labels per context 48,000 per chassis	8000 labels per context 48,000 per chassis
Number of IBGP peer	16 per context	16 per context	16 per context
Number of ILM entries	8000 labels per context 48,000 per chassis	8000 labels per context 48,000 per chassis	8000 labels per context 48,000 per chassis



Parameter	Scaling Number (Release 12.x, 14.x)	Scaling Number (Release 15.x, 16.x)	Scaling Number (Release 17.x, 18.x, 19.x, 20.x +)
Number of interfaces	512 ethernet+ppp+tunnel interfaces per context 32 IPv6 IP tunnel interfaces per context Upto 511 GRE tunnels/context and 2048 GRE tunnels/chassis 256 loopback interfaces per context	512 ethernet+ppp+tunnel interfaces per context 32 IPv6 IP tunnel interfaces per context Upto 511 GRE tunnels/context and 2048 GRE tunnels/chassis 256 loopback interfaces per context Note the information about "Demux on MIO Cards" at the end of this section.	512 ethernet+ppp+tunnel interfaces per context 32 IPv6 IP tunnel interfaces per context Upto 511 GRE tunnels/context and 2048 GRE tunnels/chassis 256 loopback interfaces per context Note the information about "Demux on MIO Cards" at the end of this section.
Number of LDP sessions	16 per context	16 per context	16 per context
Number of NEMO prefixes/Framed routes	256,000 per chassis	512,000 per chassis	512,000 per chassis
Number of OSPF neighbors	Up to 200 per chassis	Up to 200 per chassis	Up to 200 per chassis
Number of OSPF routes	Up to 10,000 per context 64,000 per chassis	Up to 10,000 per context 64,000 per chassis	Up to 10,000 per context 64,000 per chassis
Number of pool explicit host routes	5000 per context (6000 per chassis)	5000 per context (6000 per chassis)	5000 per context (6000 per chassis) in 17.x and 18.[1234] 24000 per context (24000 per chassis) in 18.5 and above
Number of pool routes	6000 per context (6000 per chassis)	6000 per context (6000 per chassis)	6000 per context (6000 per chassis)
Number of routes (excluding framed-routes)	64,000 per context	64,000 per context	64,000 per context
Number of secondary addresses per interface	16	16	16
Number of Static routes	1200 per context	1200 per context	1200 per context
Number of VLANs	4000 per chassis	4000 per chassis	4000 per chassis

Parameter	Scaling Number (Release 12.x, 14.x)	Scaling Number (Release 15.x, 16.x)	Scaling Number (Release 17.x, 18.x, 19.x, 20.x +)
Number of VRFs	250 per context 2048 per chassis APN limit is 1024/chassis and does not match the VRF limit.	300 per context 2048 per chassis <b>Note</b> <ul style="list-style-type: none"> <li>• VRF Limits and APN limits are assumed to be identical.</li> <li>• Note the "Demux on MIO Cards" section at the end of this section.</li> </ul>	300 per context 2048 per chassis Note: VRF Limits and APN limits are assumed to be identical. Note the "Demux on MIO Cards" section at the end of this section.
Number of routes (all kinds of routes including framed routes)	64,000 per context	64,000 per context	64,000 per context
Route maps	64 per context	64 per context	64 per context
Static pool addresses	32 million per context 96 million per chassis	32 million per context 96 million per chassis	32 million per context 96 million per chassis

**Demux on MIO Cards**

When enabling Demux on MIO cards, VPN resources are combined on the MIO cards with the controller processes, thus reducing the resources available for all VPN tasks. This results in reducing some of the limits (mentioned in the previous section) when MIO cards are demux-enabled.



## APPENDIX **B**

# StarOS Tasks

---

This appendix describes system and subsystem tasks running under StarOS on an ASR 5500 and virtualized platforms.



### Important

This appendix is not a comprehensive list of all StarOS tasks. It simply provides general descriptions of the primary tasks and subsystems within StarOS.

---

It includes the following sections:

- [Overview, on page 415](#)
- [Primary Task Subsystems, on page 415](#)
- [Controllers and Managers, on page 417](#)
- [Subsystem Tasks, on page 417](#)

## Overview

For redundancy, scalability and robust call processing, StarOS supports a series of tasks that perform specific functions. These tasks communicate with each other as needed to share control and data signals. As a result, processes can be distributed across multiple tasks thus reducing the overall work-load on any given task and improving system performance. This distributed design provides fault containment that greatly minimizes the impact to processes or sessions due to a failure.

The Exec mode **show task** command displays snapshots of running processes within StarOS. For detailed information about this command, see the *Command Line Interface Reference* and *Statistics and Counters Reference*.

The following sections describe the primary tasks that are implemented by StarOS:

- [Primary Task Subsystems, on page 415](#)
- [Controllers and Managers, on page 417](#)

## Primary Task Subsystems

The individual tasks that run on the CPUs are divided into subsystems. Following is a list of the primary subsystems responsible for call session processing:

- **System Initiation Task (SIT):** This subsystem starts tasks and initializes the system. This includes starting a set of initial tasks at system startup time (static tasks), and starting individual tasks on demand at arbitrary times (dynamic tasks).
- **High Availability Task (HAT):** With the Recovery Control Task (RCT) subsystem, the HAT subsystem maintains the operational state of the system. HAT monitors the various software and hardware components of the system. If there are unusual activities, such as the unexpected termination of another task, the HAT subsystem takes a suitable course of action, such as triggering an event to the RCT subsystem to take corrective action or to report the status. The primary function of the HAT task is to minimize service impacts.
- **Recovery Control Task (RCT):** This subsystem executes a recovery action for any failure that occurs in the system. The RCT subsystem receives signals from the HAT subsystem (and in some cases from the NPU subsystem) and determines what recovery actions are needed.
- **Shared Configuration Task (SCT):** This subsystem provides a facility to set, retrieve, and receive notification of system configuration parameters. The SCT is mainly responsible for storing configuration data for the applications that run on the system.

The SCT subsystem runs only on the active management card and synchronizes the information it contains with the SCT subsystem on the standby management card.

- **Resource Management (RM):** This subsystem assigns resources, such as CPU loading and memory, for every system task upon start-up. The RM subsystem monitors resource use to verify that allocations are as specified. RM also monitors all sessions and communicates with the Session Controller to enforce capacity licensing limits.
- **Virtual Private Network (VPN):** This subsystem manages the administrative and operational aspects of all VPN-related entities in the system. The functions performed by the VPN subsystem include:
  - Creating separate VPN contexts
  - Starting the IP services within a VPN context
  - Managing IP pools and subscriber IP addresses, and distributing the IP flow information within a VPN context.

All IP operations within StarOS are done within specific VPN contexts. In general, packets are not forwarded across different VPN contexts. The only exception currently is the Session subsystem.

- **Network Processing Unit (npusim on ASR 5500, and iftask or knpusim on VPC-DI and VPC-SI)<sup>1</sup>:** This subsystem is responsible for the following:
  - Using the database to match address and port numbers to destination tasks for fast-path forwarding of dataframes
  - Receiving and transmitting user data frames to/from various physical interfaces
  - IP forwarding decisions (both unicast and multicast)
  - Per-interface packet filtering
  - Traffic management and traffic engineering
  - Passing user data frames to/from packet processing CPUs

<sup>1</sup> knpusim runs instead of iftask on VPC VMs that do not have Intel DPDK supported configurations.

- Modifying, adding, or stripping datalink/network layer headers
  - Recalculating checksums
  - Maintaining statistics
  - Managing external Ethernet interfaces
- **Card/Slot/Port (CSP):** Coordinates the events that occur when any card is inserted, locked, unlocked, removed, shutdown, or migrated. CSP also performs auto-discovery and configures ports on a newly-inserted interface card. It determines how interface cards map to packet processing cards.
- The CSP subsystem runs only on the active management card and synchronizes the information it contains with the SCT subsystem on the standby management card. It is started by the SIT subsystem and monitored by the HAT subsystem.
- **Session Manager (SM):** Performs high-touch processing of mobile subscribers' packet-oriented data session flows. High-touch user data processing consists of the following:
- Payload transformation
  - Filtering and scheduling
  - Statistics collection
  - Policing

## Controllers and Managers

Many of the primary subsystems are composed of controller tasks called Controllers, and subordinated tasks called Managers.

Controllers serve several purposes:

- Monitor the state of their Managers and allow communication between Managers within the same subsystem.
- Enable inter-subsystem communication since they can communicate with the controllers of other subsystems.
- Mask the distributed nature of the software from the user allowing for ease of management.

Managers manage resources and mappings between resources. In addition, some managers are directly responsible for call processing.

For information about the primary subsystems that are composed of critical, controller, and /or manager tasks, see [Subsystem Tasks, on page 417](#).

## Subsystem Tasks

The following subsections list and briefly describe StarOS tasks for various subsystems:

- [System Initiation Subsystem, on page 418](#)

- [High Availability Subsystem, on page 419](#)
- [Resource Manager Subsystem, on page 420](#)
- [Virtual Private Networking Subsystem, on page 421](#)
- [Network Processing Unit Subsystem, on page 423](#)
- [Session Subsystem, on page 425](#)
- [Platform Processes, on page 439](#)
- [Management Processes, on page 443](#)

## System Initiation Subsystem

Table 46: System Initiation Subsystem Tasks

Task	Description	Function
SITMAIN	System Initiation Task – Main	Initiated at system start-up.
		Reads and provides startup configuration to other SIT components.
		Starts SITREAP sub-function.
		Maintains CPU state information.
SITPARENT	SIT Parent Sub-function	Starts management cards in either active or standby mode.
		Registers tasks with HAT task.
		Notifies CSP task of CPU startup completion.
		Brings up packet processing cards in standby mode.
SITREAP	SIT Reap Sub-function	Shuts down tasks as required.

# High Availability Subsystem

Table 47: High Availability Subsystem Tasks

Task	Description	Function
hatecpu	High Availability Task CPU	Performs device initialization and control functions based on the CPU's hardware capabilities.
		Reports the loss of any task on its CPU to hatsystem sub-function.
		Controls the LEDs on the packet processing cards.
		Initializes and monitors the dedicated hardware on packet processing cards. (ASR 5500 only)
		Collects CPU monitoring information periodically and reports to the master hatecpu sub-function.
		Reports the loss of any task on its CPU to the master hatecpu sub-function.
		Performs device initialization and control functions because of the CPU's hardware capabilities.
		Reports the loss of any task on its CPU to hatsystem sub-function.
		Controls the LEDs on the management card. (ASR 5500 only)
		Initializes and monitors the dedicated hardware on the management card. (ASR 5500 only)
hatsystem	High Availability Task System Controller	Controls all the HAT sub-function tasks in the system. It is initiated on system start-up.
		Initializes system components (such as the Gigabit Ethernet switches and switch fabric).
		Monitors system components such as fans for state changes.
		Triggers actions for redundancy in the event of fault detection.
		The HAT subsystem on the redundant management card mirrors the HAT subsystem on the active management card.

## Resource Manager Subsystem

Table 48: Resource Manager (RM) Subsystem Tasks

Task	Description	Function
rmctrl	Resource Manager Controller	Started by the sitparent task on StarOS startup, and monitored by HAT for a failure.
		Initializes resources such as CPUs and memory.
		Requests updated card status from the CSP subsystem and updates the system card table.
		Communicates with all rmctrls to request their most recent set of resource data.
rmmgr	Resource Manager Managers	Started by the sitparent task, and monitored by HATs for failures.
		Initializes the local resource data and local resource scratch space.
		Communicates with the SIT task on the local CPU to get its entire task table and the resources associated with each task.
		Gathers current resource utilization for each task.
		Sends the resource data to the rmctrl task.



## Virtual Private Networking Subsystem

Table 49: Virtual Private Networking (VPN) Subsystem Tasks

Task	Description	Function
vpnctrl	VPN Controller	Created at system start-up.
		Initiates the VPN Manager for each context.
		Informs the Session Controller task when there are additions or changes to contexts. Only one Session Controller operates at any time.
		Routes context specific operation information to the appropriate VPN Manager.
		Performs VPN Manager recovery and saves all VPN-related configuration information in SCT.
vpnmgr	VPN Manager	Started by the VPN Controller for each configured context (one is always present for the local context).
		Performs IP address pool and subscriber IP address management.
		Performs all context specific operations including but not limited to: UCM services, IP interfaces, the Address Resolution Protocol (ARP), IP address pool management, slow path forwarding, NPU flows, port Access Control Lists (ACLs), and logging.
		Provides IP interface address information for each context to the Session Controller.
bgp	Border Gateway Protocol	Created by the VPN Manager for each context that has enabled the BGP routing protocol ( <b>router bgp</b> Context Configuration mode CLI command).
		Responsible for learning and redistributing routing information via the BGP protocol.
		Maintains the BGP peering connections.
		Applies any defined BGP routing policy.

Task	Description	Function
ospf	Open Shortest Path First	Created by VPN Manager for each context that has enabled the OSPF routing protocol ( <b>router ospf</b> Context Configuration mode CLI command).
		Responsible for learning and redistributing routing information via the OSPF protocol.
		Maintains the OSPF neighboring relationship.
		Maintains the LSA database.
		Performs SPF calculations.
		Applies any defined OSPF routing policy
ospfv3	Open Shortest Path First	Created by VPN Manager for each context that has enabled the OSPFv3 routing protocol ( <b>router ospfv3</b> Context Configuration mode CLI command)
		Responsible for learning and redistributing routing information via the OSPFv3 protocol.
		Maintains the OSPFv3 neighboring relationship.
		Maintains the LSA database.
		Performs OSPFv3 SPF calculations.
		Applies any defined OSPFv3 routing policy.
rip	Routing Information Protocol	Created by VPN Manager for each context that has enabled the RIP routing protocol ( <b>router rip</b> Context Configuration mode CLI command)
		Responsible for learning and redistributing routing information via the RIP protocol.
		Maintains the RIP database.
		Sends periodic RIP update messages.
		Applies any defined RIP routing policy.

Task	Description	Function
zebos	L2 and L3 Switching	Created by VPN Manager for each context.
		Maintains the routing table (RIB and FIB) for the context.
		Performs static routing.
		Interfaces to the kernel for routing & interface updates.
		Redistributes routing information to dynamic routing protocols.
		Calculates nexthop reachability.

## Network Processing Unit Subsystem

Table 50: Network Processing Unit (NPU) Subsystem Tasks

Task	Description	Function
iftask	Internal Forwarder Task (Intel DPDK) [VPC-DI, VPC-SI]	Created at StarOS start up.
		Provides port configuration services to the CSP task.
		Provides interface binding and forwarding services to the VPN Manager.
		Provides flow insertion and removal services to Session Manager and AAA Manager tasks.
knpusim	Kernel-based NPU Simulator [VPC-DI, VPC-SI]	Created at StarOS start up.
		Provides port configuration services to the CSP task.
		Provides interface binding and forwarding services to the VPN Manager.
		Provides flow insertion and removal services to Session Manager and AAA Manager tasks.
		Provides recovery services to the NPU Controller.

Task	Description	Function
npuctrl	NPU Controller	Created at StarOS start-up. Only one NPU Controller operates in the system at any time.
		Monitors the state of NPU Managers in the system.
		Registers to receive notifications when NPU Manager crashes.
		Controls recovery operation.
		Provides a centralized location for CLI commands related to NPU Manager state.
npumgr	NPU Manager	Created for every packet processing card that is installed and started.
		Provides port configuration services to the CSP task.
		Provides interface binding and forwarding services to the VPN Manager.
		Provides flow insertion and removal services to Session Manager and AAA Manager tasks.
		Provides recovery services to the NPU Controller.
npusim	NPU Simulator [ASR 5500]	Created for every DPC installed and started.
		Provides port configuration services to the CSP task
		Provides interface binding and forwarding services to the VPN Manager.
		Provides flow insertion and removal services to Session Manager and AAA Manager tasks.
		Provides recovery services to the NPU Controller.

## Session Subsystem

Table 51: Session Subsystem Tasks

Task	Description	Function
sessctrl	Session Controller	Created at StarOS start-up. Only one Session Controller instantiated in the system at any time.
		Acts as the primary point of contact for the Session Subsystem. Since it is aware of the other subsystems running within the system, the Session Controller acts as a proxy for the other components, or tasks, that make up the subsystem.
		Starts, configures, and coordinates the efforts of the Session Processing Subsystem sub-managers.
		Works with Resource Manager to start new Session Managers when all existing Session Managers exceed their capacity.
		Receives context information from VPN Managers.
		Distributes IP interface address information to other Session Processing Subsystem sub-managers.
		Manages Enhanced Charging Service (ECS), Content Filtering and URL Blacklisting services.

Task	Description	Function
sessmgr	Session Manager	Created by the Session Controller.
		Provides a subscriber processing system that supports multiple session types.
		Multiple Session Managers can run on a single CPU and/or can be distributed throughout any CPU present in the system.
		A single Session Manager can service sessions from multiple A11 Managers, and from multiple contexts.
		Processes protocols for A10/A11, GRE, R3, R4, R6, GTPU/GTPC, PPP, and Mobile IP.
		Manages Enhanced Charging Service, Content Filtering and URL Blacklisting services.
allmgr	A11 Manager	Created by the Session Controller for each context in which a PDSN service is configured.
		Receives the R-P sessions from the PCF and distributes them to different Session Manager tasks for load balancing.
		Maintains a list of current Session Manager tasks to aid in system recovery.
		The A11 Manager task is also known as the Signaling De-multiplexing task (SDT).
		With session recovery (SR) enabled, this demux manager is usually established on one of the CPUs on the first active packet processing card.

Task	Description	Function
aaamgr	Authorization, Authentication, and Accounting (AAA) Manager	<p>Paired with Session Managers.</p> <p>Performs all AAA protocol operations and functions for subscribers and administrative users within the system.</p> <p>Acts as a AAA client to AAA servers.</p> <p>Manages GTP Prime (GTP') messaging with charging gateway functions (CGFs).</p> <p>Multiple AAA Managers can run on a single CPU and/or can be distributed throughout any CPU present in the system.</p> <p>AAA operations for the CLI are done through a AAA Manager running on the active management card.</p>
aaaproxy	Authorization, Authentication, and Accounting (AAA) Proxy Manager	<p>Starts whenever the Global Configuration mode <b>gtp single-source</b> command is configured.</p> <p>When GTPP single-sourcing is enabled, aaaproxy generates requests to the accounting server using a single UDP source port number, instead of having each AAA Manager generate independent requests with unique UDP source port numbers.</p> <p>Runs on a demux card when session recovery is enabled. If session recovery is not enabled, the Global Configuration mode <b>require demux card</b> command starts aaaproxy on the designated demux card.</p> <p>Writes CDRs to a file in its VRAM-disk. The enqueued CDRs are then periodically synchronized with a HDD for transfer.</p>

Task	Description	Function
acsctrl	Active Charging System (ACS) Controller	Active Charging service is defined at the global level and can be utilized through CSS commands from any VPN context. Enable via the Global Configuration mode <b>active-charging service</b> CLI command.
		The ACS controller runs on the primary packet processing card and is responsible for managing the ACS service.
		Reads and writes ACS configuration information into SCT.
		The ACS Controller monitors the ACS Manager's recovery process and performs cleanup when redundancy is enabled.
acsmgr	Active Charging System (ACS) Controller	Created by ACS Controller to perform IP session processing for a specific number of flows.
		Sends and receives data through Session Managers.
		Active/Standby acsmgr tasks are created when session recovery (SR) is enabled.
cdrmod	Charging Detail Record Module	Responsible for receiving EDR/UDR records from different ACSMGR instances in the system.
		Responsible for writing the received EDR/UDR records in files using the configured file naming conventions.
dgmbmgr	Diameter Gmb interface Application Manager	Provides Multimedia Broadcast/Multicast Service (MBMS) feature support for GGSN. It is instantiated when an MBMS policy CLI is configured in the GGSN Service configuration mode. dgmbmgr
		Maintains the MBMS UE and bearer contexts.
		Handles the Gmb interface over a Diameter connection to a BMSC Server for MBMS bearer sessions. dgmbmgr recovers by polling all sessmgrs for MBMS session states and recreating the MBMS UE and MBMS bearer context information.



Task	Description	Function
diamproxy	Diameter Proxy	<p>Created by diactrl (which runs as part of vpncntrl) and the number of diamproxy tasks spawned is based on the configuration to use "multiple" or "single" proxies. In instances that a single proxy is configured, only one diamproxy task is spawned for the entire chassis and runs on demux packet processing cards. When multiple proxies are configured, one diamproxy task is run per packet processing card.</p> <p>Maintains Diameter base connections to all peers configured in the system.</p> <p>Informs applications about any change in the connection status.</p> <p>Acts as a pass-through to the messages from application to the Diameter server.</p> <p>Just acts as a forwarding agent (does not maintain any queues).</p> <p>A single Diameter proxy is used to service multiple Diameter applications.</p>
egtpemgr	Enhanced GPRS Tunneling Protocol Egress Manager	<p>Created by the Session Controller for each context in which an egtp-service of interface type sgw-egress or MME is configured.</p> <p>Handles certain EGTP messages from SGW, PGW.</p> <p>Maintains list of current EGTP sessions.</p> <p>Maintains list of current Session Manager tasks which aids in session recovery.</p> <p>Handles GTP Echo messaging.</p> <p>With session recovery (SR) enabled, this demux manager is usually established on one of the CPUs on the first active packet processing card.</p>

Task	Description	Function
egtpimgr	Enhanced GPRS Tunneling Protocol Ingress Manager	Created by Session Controller for each context in which an egtp-service of interface type sgw-ingress or pgw-ingress is configured.
		Receives EGTP sessions from MME/S4 SGSN/SGW and distributes them to different Session Manager tasks for load balancing.
		Maintains list of current EGTP sessions.
		Maintains list of current Session Manager tasks which aids in session recovery.
		Handles GTP Echo messaging.
		With session recovery (SR) enabled, this demux manager is usually established on one of the CPUs on the first active packet processing card.
gtpcmgr	GPRS Tunneling Protocol Control (GTP-C) Message Manager	Created by the Session Controller for each context in which a GGSN service is configured.
		Receives the GTP sessions from the SGSN and distributes them to different Session Manager tasks for load balancing.
		Maintains a list of current Session Manager tasks to aid in system recovery.
		Verifies validity of GTPC messages.
		Maintains a list of current GTPC sessions.
		Handles GTPC Echo messaging to/from SGSN.

Task	Description	Function
gtpmgr	GPRS Tunneling Protocol User (GTP-U) Manager	Created by the Session Controller for each context in which a GTPU service is configured. Supported for both GTPUv0 and GTPUv1
		Maintains a list of the GTPU-services available within the context and performs load-balancing (of only Error-Ind) for them.
		Supports GTPU Echo handling.
		Provides Path Failure detection on no response for GTPU echo.
		Receives Error-Ind and demuxes it to a particular Session Manager.
		Serves as the Default GTPU listener. GTPUMGR will process GTPU packets with invalid TEID.
		With session recovery (SR) enabled, this demux manager is usually established on one of the CPUs on the first active packet processing card.
hamgr	Home Agent (HA) Manager	Created by the Session Controller for each context in which an HA service is configured.
		Receives Mobile IP sessions from the Foreign Agents (FAs) and distributes them to different Session Manager tasks.
		Maintains a list of current Session Manager tasks that aids in system recovery.
		Functions as the DemuxMgr – handles all the PMIP signaling packets.
		Functions as the Demuxmgr for MIPv6/MIPv4 HA.
		With session recovery (SR) enabled, this demux manager is usually established on one of the CPUs on the first active packet processing card.

Task	Description	Function
hnbdemux	Home NodeB (HNB) Demux Manager	Started as part of HNB-GW service creation procedure. There is only one hnbdemux in the chassis.
		Distributes incoming Iuh connections to HNB Managers in the system.
		Remains aware of all the active HNB-GW services in the system.
		With session recovery (SR) enabled, this demux manager is usually established on one of the CPUs on the first active packet processing card.
hnbmgr	Home NodeB (HNB) Manager	Starts when an HNB-GW service configuration is detected. There can be multiple instances of this task for load sharing. All HNB Managers have all the Active HNB-GW Services configured and be identical in configuration and capabilities.
		Runs the SCTP protocol stack.
		Handles the SCTP associations.
		Maintains Home-NodeB databases.
		Provides nodal functions for Iuh interface on SCTP protocol.
		With session recovery (SR) enabled, this manager is usually established on one of the CPUs on the first active packet processing card.

Task	Description	Function
imsimgr	International Mobile Subscriber Identity Manager for MME	Starts when an MME service configuration is detected. There is only one instance of this task:
		Selects which SessMgr to use for new subscriber sessions.
		Maintains and reports MME-related demux statistics on events like Attach by IMSI, Attach by GUTI, etc.
		Can interact with the following tasks in the system: <ul style="list-style-type: none"> <li>- Session Controller</li> <li>- MME Manager</li> <li>- Session Manager</li> </ul>
		With session recovery (SR) enabled, this demux manager is usually established on one of the CPUs on the first active packet processing card.
imsimgr	International Mobile Subscriber Identity Manager for SGSN	Started by the Session Controller.
		Selects SessMgr, when not done by linkmgr or sgtpcmgr tasks, for calls sessions based on IMSI/P-TMSI.
		Load-balances across SessMgrs to select one to which a subscriber will be assigned.
		Maintains records for all subscribers on the system.
		Maintains mapping between the IMSI/P-TMSI and SessMgrs.
		With session recovery (SR) enabled, this demux manager is usually established on one of the CPUs on the first active demux packet processing card.
ipsgmgr	IP Services Gateway Manager	Created by the Session Controller.
		In Server mode, acts as a RADIUS server, and supports Proxy functionality.
		In Snoop mode supports snooping RADIUS Accounting messages.
		Load balances requests among different SessMgrs.
		Activates and deactivates sessions.

Task	Description	Function
l2tpdemux	L2TP Demultiplexor Task	Created by the Session Controller when an LNS service is created. Only one L2TPDemux task is invoked for the entire system.
		De-multiplexes and forwards new incoming tunnel create requests to L2TPMgrs.
		Maintains information about current active tunnels in all L2TPMgrs.
		Load balances requests among L2TPMgrs.
		With session recovery (SR) enabled, this demux manager is usually established on one of the CPUs on the first active packet processing card.
l2tpmgr	Layer 2 Tunneling Protocol Manager	Created by the Session Controller for each context in which a LAC or LNS service is configured. Additional managers are created as needed depending on loading.
		Responsible for all aspects of L2TP processing.
		Maintains protocol state machines for all L2TP sessions and tunnels.
		Triggers IPsec encryption for new L2TP tunnels as needed.
		Works with Session Managers to gracefully bring down tunnels.
		With session recovery (SR) enabled, this demux manager is usually established on one of the CPUs on the first active packet processing card.
linkmgr	SS7 Link Manager	Created by the Session Controller when the first SS7RD (routing domain) is activated.
		Multi-instanced for redundancy and scaling purposes.
		Provides SS7 and Gb connectivity to the platform.
		Routes per subscriber signalling across the SS7 (including Iu) and Gb interfaces to the SessMgr.

Task	Description	Function
magmgr	Mobile Access Gateway (MAG) Manager	<p>Created by the Session Controller when the first MAG service is created in a context.</p> <p>Sends and receives PMIP control messages (PBU/PBA).</p> <p>Adds an NPU flow to receive MIPv6 PBA packets. This flow is identical to the flow used in the HAMgr.</p> <p>Maintains the Binding Update List used to keep track of the mobile node's bindings.</p> <p>Originates PBU-based on trigger received from the Session Manager during error conditions.</p> <p>Receives PBA and forwards it to Session Manager.</p> <p>Supports debugging facility – "magmgr" and "mobile-ipv6".</p>
mmgr	SGSN Master Manager	<p>Created upon provisioning of SS7RDs/SCCP-NWs/etc. The Session Controller provides the initial system configuration which includes a detailed description of each distributed protocol layer, its resources sets, and a list of its service user protocol layers and service provider protocol layers.</p> <p>Runs as a single instance.</p> <p>Handles nodal SS7, Iu, and Gb functionality.</p> <p>Implements master linkmgr functionality for SS7 route status aggregation.</p> <p>Implements master linkmgr functionality for RNC and BSC status aggregation.</p> <p>With session recovery (SR) enabled, this demux manager is usually established on one of the CPUs on the first active demux packet processing card.</p>

Task	Description	Function
mmedemux	Mobility Management Entity Demux Manager	Started as part of MME service creation procedure. There is only one mmedemux in the chassis.
		Distributes incoming S1-MME SCTP connections to mmemgr tasks in the system.
		Remains aware of all the active MME services in the system.
		With session recovery (SR) enabled, this demux manager is usually established on one of the CPUs on the first active packet processing card.
mmemgr	Mobility Management Entity Manager	Starts when an MME service configuration is detected. There can be multiple instances of this task for load sharing. All mmemgrs will have all the Active MME Services configured and will be identical in configuration and capabilities.
		Runs the SCTP protocol stack.
		Handles the SCTP associations.
		Maintains TA List.
		Manage eNodeB databases.
		Provides nodal functions for S1-MME protocol.
		With session recovery (SR) enabled, this demux manager is usually established on one of the CPUs on the first active packet processing card.



Task	Description	Function
pccdemux	Policy and Charging Control Bindmux Manager	Started as part of PCC service creation procedure. There is only one instance of BindMux MGR in the chassis.
		Handles multiplexing of the sessions across the available pccmgrs along with the session binding functions
		Monitors load on pccmgrs.
		Distributes incoming IP-CAN connections across pccmgrs in the system.
		Performs session binding; binds IP-CAN/Gateway session with the AF-Session.
		Ensures all messaging for an IMSI across various interfaces is directed towards the selected pccmgr.
		Remains aware of all the active PCC services in the system.
		With session recovery (SR) enabled, this demux manager is usually established on one of the CPUs on the first active packet processing card.
pccmgr	Policy and Charging Control Bindmux Manager	pccmgr is part of a Session Manager instance.
		Handles all PCRF service sessions.
		Interfaces with PCC-Core while processing different events associated with individual subscriber sessions.
		Maintains subscriber information while applying business logic.
		Creates callline and corresponding APN session for each subscriber.

Task	Description	Function
sgtpcmgr	SGSN GPRS Tunneling Protocol Control message Manager	<p>Created by the Session Controller for each VPN context in which an SGSN service is configured.</p> <p>Terminates Gn/Gp and GTP-U interfaces from peer GGSNs and SGSNs for SGSN Services.</p> <p>Terminates GTP-U interfaces from RNCs for IuPS Services.</p> <p>Controls standard ports for GTP-C and GTP-U.</p> <p>Processes and distributes GTP-traffic received from peers on these ports.</p> <p>Performs all node level procedures associated with Gn/Gp interface.</p> <p>With session recovery (SR) enabled, this demux manager is usually established on one of the CPUs on the first active demux packet processing card.</p>
srb	Standard Routing Database	<p>Eight srb's are created by the Session Controller when Content Filtering in the Enhanced Charging Service is enabled. A minimum of two packet processing cards are required to initiate these eight tasks.</p> <p>Receives the static database from the session controller. Each srb task loads two database volumes (one primary and one secondary). The srb task also stores the static DB.</p> <p>Rates and categorizes the URL based on the DB volumes and CSI (Category Set Index) stored on it.</p> <p>Performs peer loading in case its peer fails. If both the srb task and its peer fail, the session controller performs the loading.</p>

## Platform Processes

Table 52: Platform Process Tasks

Task	Description	Function
afctrl	ASR 5500 Fabric Controller	Responsible for the overall management of the system fabric. Manages the pool of Rendezvous Destinations and coordinates fabric recovery by the afmgr procllets after a fault. A single afctrl instance runs on the active MIO/UMIO only.
afmgr	ASR 5500 Fabric Manager	Responsible for the management of fabric resources on a particular card. There is one afmgr on every CPU that is responsible for one or more fabric access processors (FAPs) or fabric elements (FEs). afmgr supports recovery but not migration.
afio	ASR 5500 Fabric I/O Driver	Responsible for the direct configuration of the fabric chipset. afio supports non-messenger interprocess communication (IPC) with the local afmgr and with other local afio instances
connproxy	TCP/SCTP Connection proxy	Allows applications on any card to share the same TCP/SCTP connection to the same remote endpoint instead of opening a new connection for each application on the card.
csptctrl	Card-Slot-Port Controller	Manages physical chassis components.
cssctrl	Content Server Selection (CSS) Controller	<p>Maintains all global CSS properties which include a list of CSS servers that can be bound to a service in a context.</p> <p>CSS defines how traffic will be handled based on the "content" of the data presented by or sent to a mobile subscriber. CSS encompasses features such as load balancing, NAT, HTTP redirection, DNS redirection.</p> <p>The content server (services) can be either external to the platform or integrated within the platform. External CSS servers are configured via the Context Configuration mode <b>css server</b> command.</p> <p>The CSS Controller does not create CSS Managers. CSS Managers are stopped and started by VPN Managers. A CSS Manager is automatically created for each context.</p>

Task	Description	Function
cssmgr	Content Server Selection (CSS) Manager	Spawned by the VPN Manager within a StarOS context.
		Manages the keepalives to a CSS server within the specific VPN context.
		Fetches the CSS related information for a subscriber
		If a CSS server goes down, the cssmgr task reprograms the NPUs to by-pass the service or redistribute the data among the rest of the servers in the service.
dcardctrl	Daughter Card Controller [ASR 5500 only]	Spawns daughter card managers during system initialization and monitors daughter card managers during system steady state execution. It also spawns daughter card managers whenever a daughter card manager task fails.
dcardmgr	Daughter Card Manager [ASR 5500 only]	Responsible for managing IPSec Security Associations for AH- and ESP-based sessions.
		Interfaces with the on-board hardware accelerated cryptographic chip which executes cryptographic algorithms associated with the given IPSec Security Associations.
dhmgr	Distributed Host Manager	Started automatically on each CPU by SITPARENT.
		Coordinates establishment of locally terminated TCP, SCTP, and UDP connections on behalf of multi-instanced tasks such as Diameter endpoints among sessmgr tasks.
drvctrl	Driver Controller	Centralizes access to many of the system device drivers. It also performs temperature and voltage monitoring.
hdctrl	Hard Drive Controller	Controls and manages the drive array spanning the management cards.
hwctrl	Hardware Controller	The hwctrl task has several timers that manage polling loops for hardware sensor readings, sensor threshold monitoring, and fan tray monitoring.

Task	Description	Function
hwmgr	Hardware Manager	The hwmgr task runs on all cards in the chassis to read local accessible hardware sensors and report them back to the hwctrl.
inetd	InterNET Service Daemon	<p>The subsystem responsible for starting most of the network services.</p> <p>Listens for requests from connecting clients, such as FTP, SFTP, and telnet. When a TCP packet or UDP packet arrives with a particular destination port number, inetd launches the appropriate server program to handle the connection.</p> <p><b>Note:</b> In release 20.0 and higher <u>Trusted</u> StarOS builds, FTP and Telnet are not supported.</p>
ipsectrl	IPSec Controller	<p>Started by SIT on system startup regardless of configuration.</p> <p>Starts ipsecmgr tasks based on configuration and maintains its list for task recovery.</p> <p>Receives and maintains user configuration for IPSec.</p> <p>Manages the configured IPSec crypto maps and its assignment to ipsecmgrs.</p> <p>Interfaces with the vpnmgr task for required IPSec configuration parameters such as IP Access Lists, IP pools, interface addresses, and interface state notifications.</p>
ipsecmgr	IPSec Manager	Created by the Session Controller, establishes and manages secure IKEv1, IKEv2 and IPSec data tunnels.
kvctrl	Key Value Controller	Central key value store (kvstore) function that runs on the management card. Its primary function is to support recovery and distribution functions.
lagmgr	Link Aggregation Group Manager [ASR 5500 only]	<p>Started by npuctrl on the demux card's primary MIO (ASR 5500) with a facility level between CSP and npumgr to receive configuration/status notification from npumgr and build global LAG database.</p> <p>Exchanges control packets (LACP and Marker) over configured physical ports with peers to reach agreement on an aggregation of links.</p>

Task	Description	Function
msgd	Messenger Daemon	Implements the Name Service and related functions for the internal message passing system.
msgproxy	Message Proxy	The Messenger Proxy process handles broadcast messages send from any single application (referred to as a client) to any facility which has one instance per thread (referred to as the Target Facility).
		One msgproxy task runs on each CPU complex on the DPCs (ASR 5500) and SF Virtual Machine (VPC-DI).
		Processes incoming broadcast messages from the Client processes, such as sessctrl, distributes them to the correct Target Facility, such as sessmgr, creates the correct responses and sends them back to the correct Client.
nscontrol	Name Service Controller	As part of the Messenger process, provides a reliable channel for tasks to send control messages to the Messenger Daemon.
ntpd	Network Time Protocol (NTP) Daemon	Maintains the system time in synchronization with time servers using NTP. Enabled when one or more NTP servers have been configured via the NTP Configuration mode <b>ntp server</b> CLI command.
rct	Recovery Control Task	Monitors tasks/managers/facilities across the system and performs recovery in the event of a failure.
sct	Shared Configuration Task	Performs the redundant storage of configuration information and other state information in an in-memory database.
sft	Switch Fabric Task	Monitors the switch fabric and the gigabit Ethernet control plane.
sshd	Secure SHell Daemon	Supports secure login to the StarOS CLI. Enabled via the Context Configuration mode <b>server sshd</b> CLI command.

Task	Description	Function
ucm	Utilities Configuration Manager	DHCPD, DNS, FTPD, INETD, NTPD, PING, RLOGIN, SFTPD, SFTP-SERVER, SNMPD, SSH, SSHD, TELNET, TELNETD, TFTP, TRACEROUTE  <b>Note:</b> In release 20.0 and higher <u>Trusted</u> StarOS builds, FTP and Telnet are not supported.

## Management Processes

Table 53: Management Process Tasks

Task	Description	Function
bulkstat	Bulk Statistics Manager	Periodically polls and gathers bulk statistics and transfers this data to external management systems.
evlogd	Event Log Daemon	Handles event logging functions including the interface to external syslogd servers and the internal event logs.
orbs	ORBEM Service [ASR 5500 only]	The orbs task is also known as the ORB Element Manager (ORBEM).  An Element Management System (EMS) requests orbs to perform Element Management Functions on the system using secure IOP. ORBS then interacts with concerned Controller Tasks to execute the function.  The response/errors from the execution are interpreted, formulated into an EMF response, and handed off to EMS servers.
orbns	ORBEM Notification Service [ASR 5500 only]	Notifies the EMS servers of event occurrences.  Registers such EMS servers and subscribes them to associated event types.  As the events occur, the concerned Controller Task notifies orbs (ORBEM), which then notifies the subscribing EMS servers.

Task	Description	Function
sesstrc	Session Trace Collection Task	<p>Implements the standards-based session trace functionality.</p> <p>Manages both CLI and signaling-based subscriber traces. It collects messages to be traced and generates trace files as needed. It uploads trace files to the Trace Collection Entity as needed.</p>
snmp	Simple Network Management Protocol	Handles inboard SNMP operations if configured, and sends SNMP notifications (traps) if enabled.
threshold	Threshold Server	Handles monitoring of threshold crossing alerts, if configured. Polls the needed statistics/variables, maintains state, and generates log messages/SNMP notification of threshold crossings.





## APPENDIX **C**

# NETCONF and ConfD

This chapter describes NETCONF and the StarOS process called ConfD manager.

It contains the following sections:

- [Feature Summary and Revision History, on page 445](#)
- [Overview, on page 446](#)
- [Configuring ConfD, on page 448](#)
- [Verifying the Configuration, on page 453](#)
- [YANG Models, on page 459](#)
- [Show Support Details \(SSD\), on page 460](#)
- [ConfD Examples, on page 460](#)
- [ConfD Upgrade Support, on page 465](#)
- [CLI Based YANG Model for ECS Commands, on page 465](#)

## Feature Summary and Revision History

### Summary Data

Applicable Product(s) or Functional Area	All
Applicable Platform(s)	ASR 5500 VPC-SI VPC-DI
Feature Default	Disabled - Configuration Required
Related Changes in This Release	Not Applicable
Related Documentation	<ul style="list-style-type: none"><li>• <i>ASR 5500 System Administration Guide</i></li><li>• <i>Command Line Interface Reference</i></li><li>• <i>VPC-DI System Administration Guide</i></li><li>• <i>VPC-SI System Administration Guide</i></li></ul>

## Revision History



**Note** Revision history details are not provided for features introduced before releases 21.2 and N5.5.

Revision Details	Release
<p>Added support for capturing key performance indicators (KPIs) for Node Selection and Load Balancing (NSLB).</p> <p>The <b>kpi</b> command in NETCONF Protocol Configuration Mode has been added to enable this functionality and set the interval used to gather these KPIs.</p> <p>Refer to the <a href="#">kpi, on page 449</a> and <a href="#">show confdmgr Command, on page 453</a> sections for more information.</p>	21.6
<p>SNMP MIB alerts and alarms are now able to be sent via NETCONF notifications.</p> <p>The <b>netconf</b> command in NETCONF Protocol Configuration Mode added a <b>snmp</b> keyword to enable this functionality.</p> <p><b>show confdmgr</b> command output expanded.</p>	21.3
<p>ConfD may now collect bulkstats operational data that is retrieved via REST interface.</p> <p>New StarOS bulkstats and server ConfD configuration YANG models are supported. Any updates via StarOS CLI are now automatically synced back to the ConfD Database. The CLI based YANG model is only applicable to StarOS ECS (Enhanced Charging System) commands.</p> <p>NETCONF Protocol Configuration Mode added <b>bulkstats</b>, <b>netconf</b>, and <b>rest</b> commands. <b>autosave-config</b> command obsoleted.</p> <p><b>show confdmgr</b> command added keywords <b>model bulkstats</b> and <b>model confd</b>.</p> <p><b>show confdmgr</b> command output expanded.</p>	21.2
First introduced.	Pre 21.2

## Overview

StarOS provides a northbound NETCONF interface that supports a YANG data model for transferring configuration and operational data with the Cisco Network Service Orchestrator (NSO). It also incorporates a ConfD manager (confdmgr) to communicate with the NSO management console.

NETCONF (Network Configuration Protocol) is a network management protocol developed and standardized by the IETF (RFC 6241). It provides mechanisms to install, manipulate, and delete the configuration of network devices. Its operations are realized on top of a simple remote procedure call (RPC) layer. The NETCONF protocol uses XML-based data encoding for the configuration data as well as the protocol messages. The protocol messages are exchanged on top of a secure transport protocol.

ConfD is an on-device management framework that provides a set of interfaces to manage a device. The ConfD framework automatically renders all the management interfaces from a data model. ConfD implements the full NETCONF specification and runs over SSH with content encoded in XML.

ConfD is configured to allow only authenticated/authorized access through external authentication. The `confdmgr` provides a standalone CLI module for ConfD to invoke when authenticating/authorizing any new users. ConfD is configured to allow only authorized access through StarOS authentication. Upon authentication, the user is given a privilege level (0-15) which is mapped to StarOS `secure admin`, `admin`, `operator`, and `inspector`, as defined in the YANG model. StarOS logs CLI authentication event/status messages for each ConfD authentication request.

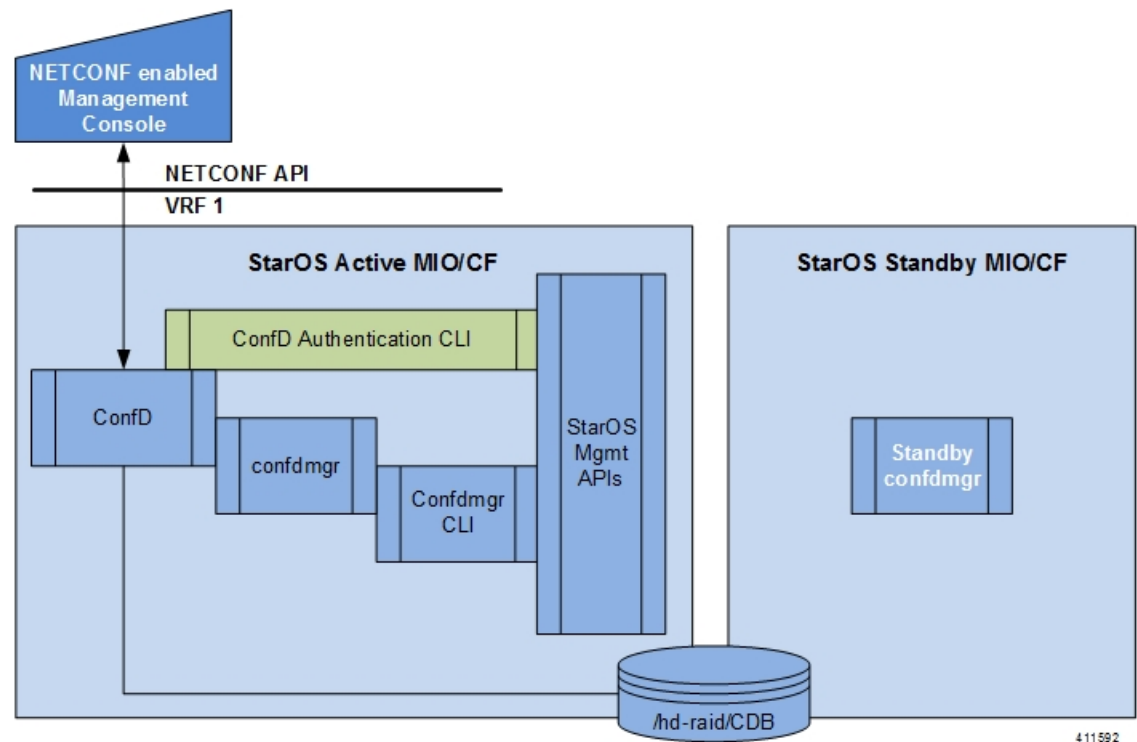
On the southbound side, ConfD communicates with a StarOS process called via a set of APIs provided by the ConfD management agent. The ConfD Configuration Database (CDB) is used by ConfD to store objects. StarOS accesses the database through the ConfD-supplied APIs. Any updates via StarOS CLI are automatically synced back to the CDB.

YANG is a data modeling language for the NETCONF network configuration protocol. It can be used to model both configuration data as well as state data of network elements. YANG can also be used to define the format of event notifications emitted by network elements and it allows data modelers to define the signature of remote procedure calls that can be invoked on network elements via the NETCONF protocol (RFC 6020). The YANG file is compiled as part of StarOS and incorporates existing StarOS supported CLI commands.

ConfD may also collect bulkstats operational data. When enabled, StarOS will send schema information to `confdmgr` while gathering statistics. Collected bulkstats are stored in the ConfD CDB for later retrieval over REST (Representational State Transfer) interface. RESTCONF is an IETF draft (draft-bierman-netconf-restconf-4) that describes how to map a YANG specification to a RESTful interface using HTTP as transport. REST and RESTCONF are only enabled internally when a valid certificate and key are configured. If client authentication is enabled, CA-certificates may be required as well.

For additional NSO information, refer to the NSO user documentation.

**Figure 35: NETCONF System Flow**



## Configuring ConfD

To enable NETCONF protocol in StarOS, you must enable **server confd** and enter the NETCONF Protocol Configuration mode. The NETCONF Protocol Configuration mode supports optional configuration commands.

### SSH Key Requirement

NETCONF-ConfD support requires that a V2-RSA SSH key be configured on the local context.

If an SSH key is not available, StarOS generates an error message.

Failure: The ConfD (NETCONF) server requires an RSA key on the local context

You can run the **show ssh key** command to verify the existence of an SSH key on the system.

If an SSH key is not available, see the *Configuring SSH Options* section of the *Getting Started* chapter in this guide.

### NETCONF Protocol Configuration Mode

The NETCONF protocol is enabled via the Context Configuration mode **server conf** command. This command is restricted to the local context only.

```
[local]host_name# configure
[local]host_name(config)# context local
[local]host_name(config-ctx)# server confd
[local]host_name(config-confd)# ?

bulkstats - Populate ConfD with bulkstats operational data
confd-user - Configures the default login user with full administrator rights
 for the ConfD server.
do - Spawns an exec mode command which displays
 information to the administrator
end - Exits configuration mode and returns to Exec Mode
exit - Exits current configuration mode, returning to previous mode
kpi - Key performance indicators gathering interval
netconf - Configure the netconf interface
no - Enables/Disables the followed option
rest - Configure the rest interface
```

The following keywords are optional:

- **bulkstats**
- **confd-user**
- **kpi**
- **netconf**
- **rest**

To disable NETCONF protocol, run the **no server confd** command in Context Configuration mode.

For additional information, see the *NETCONF Protocol Configuration Mode Commands* chapter of the *Command Line Interface Reference*.

## bulkstats

This NETCONF Protocol Configuration mode command enables bulkstats collection and reporting via REST interface. By default, this command is disabled.

The command syntax is: **bulkstats**.

During StarOS statistics gathering, bulk statistics are also stored in the CDB for later retrieval over REST interface.

Use **no bulkstats** to disable populating ConfD with bulkstats operational data.

For additional information, see the *NETCONF Protocol Configuration Mode Commands* chapter of the *Command Line Interface Reference*.

## confd-user

This NETCONF Protocol Configuration mode command associates a username for all CLI operations via NETCONF. The user will be authenticated with verifiable credentials. This username is used for CLI logging purposes only.

The command syntax is: **confd-user** <username>, where <username> is an alphanumeric string of 1 to 144 characters.



---

**Important**

The NETCONF or RESTful session must still be established with verifiable credentials.

---

## kpi

This NETCONF Protocol Configuration mode configures the Key Performance Indicator (KPI) collection interval for NSLB.

The command syntax is: **kpi** seconds, where seconds is an integer value of 0 (disabled), or 10 through 120 which sets the time interval in seconds for collecting the following KPIs:

- Percentage session CPU usage
- Percentage session memory usage
- Percentage non-session CPU usage
- Percentage non-session memory usage
- Percentage session usage

These statistics are captured system-wide (across all cards). By default, this functionality is disabled.

For additional information, see the *NETCONF Protocol Configuration Mode Commands* chapter of the *Command Line Interface Reference*.

## netconf notifications events

This NETCONF Protocol Configuration mode command enables events logged in StarOS to be sent out as NETCONF notifications on the stream named "StarOS." Level specifies the lowest event severity level that results in a notification.

The command syntax is: **netconf notifications events level { critical | error | warning | unusual | info }**, where

- **critical** - Level 1: Reports critical errors contained in log file.
- **error** - Level 2: Reports error notifications contained in log file.
- **warning** - Level 3: Reports warning messages contained in log file.
- **unusual** - Level 4: Reports unexpected errors contained in log file.
- **info** - Level 5: Reports informational messages contained in log file.

Use **no netconf notifications events** to disable NETCONF notifications.




---

**Important** Any event that is of category "critical-info" (regardless of severity) will also be converted to notifications.

---

## netconf notifications snmp

This NETCONF Protocol Configuration mode command enables SNMP alerts and alarms to be sent out as NETCONF notifications on the stream named "StarOS\_SNMP".

The command syntax is: **netconf notifications snmp**.

Use **no netconf notifications snmp** to disable NETCONF notifications.

## netconf port

This NETCONF Protocol Configuration mode command sets the NETCONF interface port number. When **server confd** is enabled, the default port is automatically set to 830.

The command syntax is: **netconf port *port\_number***, where *port\_number* must be an integer from 1 through 65535.

Use **no netconf port** to reset the port number to 830.




---

**Important** A change to the NETCONF interface port value will result in a planned restart of ConfD and temporary loss of connectivity over the NETCONF and REST (if enabled) interfaces.

---

## rest auth-policy

This NETCONF Protocol Configuration mode command controls the level of verification the server does on client certificates. CA (certificate authority) certificates can be configured using the existing **ca-certificate** command in Global Configuration mode.

The command syntax is: **rest auth-policy { none | peer | peer-fail }**, where

- **none** - No authentication performed.
- **peer** - If the client does not provide a certificate, or the client provides a certificate and it is valid, the connection is allowed. If the client provides a certificate that is not valid, the connection is aborted.



**Important** If **peer** is selected, CA certificates are recommended; otherwise, a client providing a valid certificate cannot be authenticated and connection will fail.

---

- **peer-fail** - Server requires the client to supply a client certificate and will fail the connection if certificate is not successfully validated.



**Important** If **peer-fail** is selected, one or more CA certificates must be present on the device; otherwise, the REST interface will not be enabled.

---

Use **no rest auth-policy** to set the auth-policy to **none**; no authentication will be performed.



**Important**

A change to the REST interface auth-policy may result in a planned restart of ConfD and temporary loss of connectivity over the NETCONF and REST (if still enabled) interfaces.

Changes to global certificates which ConfD is using while REST is enabled will also result in a restart of ConfD.

---

## rest certificate

This NETCONF Protocol Configuration mode command configures certificate and private-key for REST interface.

The command syntax is: **rest certificate** *certificate\_name*, where *certificate\_name* is an alphanumeric string of 1 to 128 characters.



**Important**

The certificate specified must to be present on the device. Certificate and the associated private-key can be configured using the existing **certificate** command in Global Configuration mode.

---

Use **no rest certificate** to remove any configured certificate and key. REST will not be operational without a valid certificate and key.



**Important**

A change to the REST interface certificate may result in a planned restart of ConfD and temporary loss of connectivity over the NETCONF and REST (if still enabled) interfaces.

Changes to global certificates which ConfD is using while REST is enabled will also result in a restart of ConfD.

---

## rest hostname

This NETCONF Protocol Configuration mode command specifies a hostname the web server will serve. If configured, mandates the web server to only service requests whose Host field matches the configured hostname.

The command syntax is: **rest hostname** *host\_name*, where *host\_name* is an alphanumeric string of 1 to 63 characters.

Use **no rest hostname** to use the system name; matching of hostname is not mandated.



### Important

A change to the REST interface hostname may result in a planned restart of ConfD and temporary loss of connectivity over the NETCONF and REST (if still enabled) interfaces.

Changes to global certificates which ConfD is using while REST is enabled will also result in a restart of ConfD.

## rest port

This NETCONF Protocol Configuration mode command sets the REST interface port number.

The command syntax is: **rest port** *port\_number*, where *port\_number* must be an integer from 1 through 65535.

Use **no rest port** to reset the port number to default 443.



### Important

A change to the REST interface port value may result in a planned restart of ConfD and temporary loss of connectivity over the NETCONF and REST (if still enabled) interfaces.

Changes to global certificates which ConfD is using while REST is enabled will also result in a restart of ConfD.

## Sample Configuration

The following command sequence establishes a ConfD configuration in support of NETCONF protocol.

A type v2-RSA SSH key is required for enabling **server confd**.

```
configure
 context local
 ssh key
 <encrypted key text>
 len 938 type v2-rsa
 server confd
 bulkstats
 confd-user NETCONF
 rest certificate rest-cert
 #exit
 subscriber default
 exit
 aaa group default
 #exit
 gtp group default
 #exit
```



```
#exit
end
```

Notes:

- **bulkstats**, **confd-user**, and **rest** are optional. Just configuring **server confd** enables NETCONF support.

## Verifying the Configuration

There are two Exec mode **show** commands that display information about the NETCONF-ConfD configuration.

### show confdmgr Command

This command displays information about the StarOS ConfD Manager (confdmgr) process.

The syntax for this command is:

```
show confdmgr [confd { cdb | netconf | state } | model { bulkstats | confd } | subscriptions] [| { grep grep_options | more }]
```

Notes:

- The **confd** keyword displays information about the ConfD engine based on the specified keyword in the following options:
  - **cdb** displays ConfD CDB information
  - **netconf** displays NETCONF state information
  - **state** displays current ConfD state information
- The **model** keyword displays information about the ConfD model based on the specified keyword in the following options:
  - **bulkstats** bulk statistics configuration and operational data
  - **confd** server ConfD configuration
- The **subscriptions** keyword displays ConfD CDB subscription information.

#### show confdmgr

See below for a sample output for **show confdmgr**:

```
[local]<host_name># show confdmgr

State Information

State Started
Subscriptions 5
Last successful id 1461-704882-705350
Last failed id None
Username Not configured
Bulkstats Enabled
Kpi interval 30
Event notification level Disabled
SNMP notifications Disabled
```

```

REST interface authentication none
REST interface certificate rest-cert
REST interface host name Not configured

Interface Status Port

NETCONF Enabled 830
REST Enabled 443

Statistics

Triggers 1
Replays 0
Notifications 5
Notification failures 0
Trigger failures 0
Replay failures 0
NETCONF notification failures 0
Unexpected failures 0
[local]<host_name>#

```

The Statistics portion of this output includes the following information:

- **Triggers** – Number of times confdmgr has requested ConfD to dump the CDB contents back into confdmgr, which results in a configuration synchronization to SCT (Shared Configuration Task).
- **Replays** – Number of times a transaction has been replayed. A replay is initiated if, upon startup, the last successful transaction ID in confdmgr does not match that of ConfD. This could occur, for example, if confdmgr task restarted when processing the notification for a configuration transaction.
- **Notifications** – Number of times ConfD has sent a configuration update to confdmgr. For example, this can occur as the result of a "commit" via confd\_cli or during a trigger event.
- **Notification failures** – Number of times configuration received from ConfD was not processed successfully.
- **Trigger failures** – Number of times a CDB dump to confdmgr failed.
- **Replay failures** – Number of times an attempt to replay a transaction failed.
- **NETCONF notification failures** – Number of times an attempt to issue a NETCONF notification failed.
- **Unexpected failures** – Number of times an unexpected condition was encountered. An error log is generated for each case.

### show confdmgr confd cdb

See below for a sample output for **show confdmgr confd cdb**:

```

[local]<host_name># show confdmgr confd cdb
bulkstats server collection true
bulkstats server historical-collection false
bulkstats server gather-on-standby true
bulkstats server sample-interval 60
bulkstats server transfer-interval 1440
bulkstats server limit 7500
bulkstats server receiver-mode secondary-on-failure
bulkstats server file 1
!
bulkstats schemas file 1
 schema-type system
 schema abc

```

```

 format %host%
 active-only false
 !
 schema common
 format %host%,%ipaddr%,%time%,%uptime%,%swbuild%,%localtz%
 active-only false
 !
 schema systemSch11
 format
PPM,system,systemSch11,%epochtime%,%localdate%,%localtime%,%uptime%,%diameter-msg
-saans%,%diameter-msg-sarretry%,%diameter-msg-saatimeout%,%diameter-msg-saadropped%,%diameter-ms
g-uareq%,%diameter-msg-uaans%,%diameter-msg-uarretry%,%diameter-msg-uaatimeout%,%diameter-msg-ua
adropped%,%diameter-msg-lireq%,%diameter-msg-lians%,%diameter-msg-lirretry%,%diameter-msg-liatim
eout%,%diameter-msg-liadropped%,%diameter-msg-rtreq%,%diameter-msg-rtans%,%diameter-msg-rtrejec
t%,%diameter-msg-ppreq%,%diameter-msg-ppans%,%diameter-msg-pprreject%,%diameter-msg-dereq%
 active-only false
 !
 !
 !
 confd bulkstats true
 confd netconf port 830
 confd rest port 443
 confd rest auth-policy none
 confd rest certificate rest-cert
 nacm read-default permit
 nacm groups group admin
 !
 nacm groups group inspector
 !
 nacm groups group operator
 !
 nacm groups group secure_admin
 !
 nacm rule-list secure_admin
 !
 group [secure_admin]
 rule any-access
 action permit
 !
 rule secure_admin_server_confid
 module-name cisco-staros-cli-config
 path /context/server/confd
 access-operations create,read,update
 action permit
 |
 |
 V
 nacm rule-list inspector
 group [inspector]
 rule any-access
 access-operations read
 action permit
 !
 !
 [local]<host_name>#

```

### show confdmgr confd netconf

See below for a sample output for **show confdmgr confd netconf**:

```

[local]<host_name># show confdmgr confd netconf
netconf-state capabilities capability urn:ietf:params:netconf:base:1.0
netconf-state capabilities capability urn:ietf:params:netconf:base:1.1
netconf-state capabilities capability urn:ietf:params:netconf:capability:writable-running:1.0

```

```

netconf-state capabilities capability urn:ietf:params:netconf:capability:candidate:1.0
|
|
V
netconf-state statistics netconf-start-time 2016-03-30T17:09:49-04:00
netconf-state statistics in-bad-hellos 0
netconf-state statistics in-sessions 0
netconf-state statistics dropped-sessions 0
netconf-state statistics in-rpcs 0
|
|
V
netconf-state datastores datastore candidate
netconf-state schemas schema cisco-staros-bulkstats 2016-12-14 yang
namespace http://www.cisco.com/staros-bulkstats
location [NETCONF]
netconf-state schemas schema cisco-staros-bulkstats-config 2016-12-14 yang
namespace http://www.cisco.com/staros-config
location [NETCONF]
|
|
V
NAME CREATOR CREATED CONTEXT

/rollback0 system 2017-01-17T13:40:53-00:00 system
/rollback1 system 2017-01-17T13:40:52-00:00 system
/rollback2 system 2017-01-17T13:40:52-00:00 system
/rollback3 system 2017-01-17T13:40:52-00:00 system
/rollback4 system 2017-01-17T13:36:43-00:00 system
|
|
V
/cli-history/admin.hist
/cli-history/root.hist
/global.data

netconf-state streams stream NETCONF
description "default NETCONF event stream"
replay-support false
netconf-state streams stream StarOS
description "StarOS Notifications"
replay-support true
replay-log-creation-time 2017-02-10T16:00:59+00:00
[local]<host_name>#

```

### show confdmgr confd state

See below for a sample output for **show confdmgr confd state**:

```

[local]<host_name># show confdmgr confd state
Monday June 24 10:58:49 EDT 2019
confd-state version 7.1
confd-state epoll false
confd-state daemon-status started
confd-state loaded-data-models data-model acs-config
revision 2016-10-31
namespace http://www.cisco.com/usp/nfv/acs-config
prefix acs-config
exported-to-all
confd-state loaded-data-models data-model cisco-staros-bulkstats
revision 2016-12-14
namespace http://www.cisco.com/staros-bulkstats
prefix staros_bulkstats
exported-to-all

```

```

confd-state loaded-data-models data-model cisco-staros-cli-config
 revision 2016-12-14
 namespace http://www.cisco.com/staros-cli-config
 prefix staros_cli
 exported-to-all
confd-state loaded-data-models data-model cisco-staros-config
 revision 2016-12-14
 namespace http://www.cisco.com/staros-config
 prefix staros_config
 exported-to-all
confd-state loaded-data-models data-model cisco-staros-exec
 revision 2016-12-14
 namespace http://www.cisco.com/staros-exec
 prefix staros_exec
 exported-to-all
confd-state loaded-data-models data-model cisco-staros-kpi
 revision 2017-10-31
 namespace http://www.cisco.com/staros-kpi

```

### show confdmgr model bulkstats

See below for a sample output for **show confdmgr model bulkstats**:

```

[local]<host_name># show confdmgr model bulkstats

Model: Bulkstats

Operational Data:
 Requests 277
 Records 831
 Failures 0

Configuration:
 CLI updates 0
 NETCONF updates 2
 Aborts 0
 Failures 0
[local]<host_name>#

```

The Operational Data portion of this output includes the following information:

- **Requests** – Number of operational data msg requests from bulkstats to confdmgr.
- **Records** – Number of operational data schema records processed.
- **Failures** – Number of errors detected in confdmgr while processing push requests from bulkstats.

The Configuration portion of this output includes the following information:

- **CLI updates** – Number of push configuration requests from the CLI as well as configuration loads from SCT.
- **NETCONF updates** – Number of bulkstats subscription notifications.
- **Aborts** – Number of times a configuration update via NETCONF was aborted.
- **Failures** – Number of errors detected processing any bulkstats configuration requests within confdmgr.

### show confdmgr model confd

See below for a sample output for **show confdmgr model confd**:

```
[local]<host_name># show confdmgr model confd

Model: ConfD

CLI updates 0
NETCONF updates 1
Aborts 0
Failures 0
local]<host_name>#
```

- **CLI updates** – Number of push configuration requests from the CLI as well as configuration loads from SCT.
- **NETCONF updates** – Number of ConfD configuration subscription notifications.
- **Failures** – Number of errors detected processing any ConfD configuration requests within confdmgr.
- **Aborts** – Number of times a configuration update via NETCONF was aborted.

### show confdmgr subscriptions

See below for a sample output for **show confdmgr subscriptions**:

```
[local]<host_name># show confdmgr subscriptions

Subscriptions:
Path Index Namespace

/active-charging 6 http://www.cisco.com/staros-cli-con
fig
/context 7 http://www.cisco.com/staros-cli-con
fig
/bulkstats/server 8 http://www.cisco.com/staros-config
/bulkstats/schemas 9 http://www.cisco.com/staros-config
/confd 10 http://www.cisco.com/staros-config
[local]<host_name>#
```

Subscriptions are configuration points defined in the Yang model for which confdmgr wants to be notified when a change occurs.

## clear confdmgr confd cdb

This Exec mode command erases the configuration in the ConfD Configuration Database (CDB) which is used by ConfD to store configuration objects. StarOS accesses the database via ConfD-supplied APIs.




---

**Note** The CDB cannot be erased unless the Context Configuration mode **no server confd** command is run in the local context to disable ConfD and NETCONF protocol support.

---

The following is a sample command sequence for clearing the CDB:

```
[local]host_name# config
[local]host_name(config)# context local
[local]host_name(config-ctx)# no server confd
[local]host_name(config-ctx)# end
[local]host_name# clear confdmgr confd cdb
About to delete the ConfD configuration database
```

```
The running configuration is NOT affected.
Are you sure? [Yes|No]: Y
[local]host_name#
```

**Caution**

Clearing the CDB is a terminal operation. The CDB will be repopulated when the Context Configuration mode **server confd** command is run in the local context to re-enable ConfD and NETCONF protocol support.

## clear confdmgr statistics

This command clears everything listed in the "Statistics" section of the output of the **show confdmgr** command, including:

- Triggers
- Replays
- Notifications
- Notification failures
- Trigger failures
- Replay failures
- NETCONF notification failures
- Unexpected failures

## YANG Models

The following YANG files are available in the StarOS installation:

- **cisco-staros-bulkstats-config.yang** - StarOS native bulkstats configuration model.
- **cisco-staros-bulkstats-schema-types.yang** - An extension to the **cisco-staros-bulkstats-config.yang** model that contains an enumerated list of schema names pulled directly from the code.
- **cisco-staros-bulkstats.yang** - Operational data model that enables customers to obtain bulk statistics via the RESTful interface. Only users with admin credentials may use this model.
- **cisco-staros-cli-config.yang** - Obsolete CLI-centric model introduced in StarOS release 20.2; model no longer supported.
- **cisco-staros-confd-config.yang** - Native server ConfD configuration model.
- **cisco-staros-config.yang** - Container yang file used to include all other cisco-staros-\* configuration models (all native models are included here under a common namespace).
- **cisco-staros-exec.yang** - Model to enable CLI exec operations via the restful interface. Only users with admin credentials may use this model. Used by ConfD locally to parse input.
- **cisco-staros-notif.yang** - Model to enable NETCONF notification streams for StarOS event logging. Debug level events are not supported; only informational messages and above are supported.



**Important** The ConfD server must be started at least once before these YANG files are populated and available.

YANG files must be pulled to the Cisco NSO to build StarOS Network Element Drivers (NEDs).

To copy YANG files, enter commands similar to the following:

```
#copy /hd-raid/confd_dir/etc/confd/cisco-staros-confd-config.yang
sftp://<user>:<password>@<host>/sftp-directory/cisco-staros-confd-config.yang
```

## Show Support Details (SSD)

The output of all **show confdmgr** commands has been added to the SSD.

## ConfD Examples

### Server ConfD

The following examples use full TLS authentication and curl to obtain server ConfD configuration.

#### Server ConfD Configuration

See below for a sample configuration for server ConfD with RESTful interface enabled using non-default NETCONF and HTTPS ports:

```
[local]<host_name># show configuration confd
[local]<host_name># config
[local]<host_name>(config)# ca-certificate name ca-cert pem url /flash/ssl/rootCA.pem
[local]<host_name>(config)# certificate name rest-cert pem url /flash/ssl/host.crt private-key
pem url /flash/ssl/host.key
[local]<host_name>(config)# end
[local]<host_name># config
[local]<host_name>(config)# context local
[local]<host_name>(config-ctx)# server confd
[local]<host_name>(config-confd)# netconf port 123
[local]<host_name>(config-confd)# rest port 234
[local]<host_name>(config-confd)# rest certificate rest-cert
[local]<host_name>(config-confd)# rest auth-policy peer-fail
[local]<host_name>(config-confd)# end
[local]<host_name># show confdmgr
```

#### State Information

```

State Started
Subscriptions 5
Last successful id 1488-211047-99241
Last failed id None
Username Not configured
Bulkstats Disabled
Event notification level Disabled
SNMP notifications Disabled
REST interface authentication peer-fail
REST interface certificate rest-cert
REST interface host name Not configured
```



Interface	Status	Port
NETCONF	Enabled	123
REST	Enabled	234

#### Statistics

Triggers	1
Replays	0
Notifications	8
Notification failures	0
Trigger failures	0
Replay failures	0
NETCONF notification failures	0
Unexpected failures	0

### Using Netconf-console to Obtain the Server ConfD Configuration

See below for a sample use of netconf-console to obtain the server ConfD configuration via NETCONF:

```
[user@server]$./netconf-console --host 1.2.3.4 -u admin --password pswd! --port 123
--get-config -x confd
<?xml version="1.0" encoding="UTF-8"?>
<rpc-reply xmlns="urn:ietf:params:xml:ns:netconf:base:1.0" message-id="1">
 <data>
 <confd xmlns="http://www.cisco.com/staros-config">
 <bulkstats>>false</bulkstats>
 <netconf>
 <port>123</port>
 </netconf>
 <rest>
 <port>234</port>
 <auth-policy>peer-fail</auth-policy>
 <certificate>rest-cert</certificate>
 </rest>
 </confd>
 </data>
</rpc-reply>
```

#### Notes:

- netconf-console is freely available from GitHub (<https://github.com/tail-f-systems/JNC/blob/master/examples/2-junos/netconf-console>).

### Using Curl to Obtain the Server ConfD Configuration

See below for a sample use of curl to perform the same get-config operation:

```
[<user>@server]]$ curl -u admin:pswd!
https://rtp-mitg-si06.cisco.com:234/api/running/confd?deep --cert
/users/<user>/ssl_cert/client_cert/client.crt --key
/users/<user>/ssl_cert/client_cert/client.key --cacert
/users/<user>/ssl_cert/root_cert/rootCA.pem

<confd xmlns="http://www.cisco.com/staros-config" xmlns:y="http://tail-f.com/ns/rest"
xmlns:staros_config="http://www.cisco.com/staros-config">
 <bulkstats>>false</bulkstats>
 <netconf>
 <port>123</port>
 </netconf>
 <rest>
 <port>234</port>
```

```

 <auth-policy>peer-fail</auth-policy>
 <certificate>rest-cert</certificate>
 </rest>
</confd>

```

## Bulkstats

The following examples show bulk statistics operational data.

### Enable Bulkstats

Enable bulkstats under server ConfD:

```

[local]<host_name># config
[local]<host_name>(config)# context local
[local]<host_name>(config-ctx)# server confd
[local]<host_name>(config-confd)# bulkstats
[local]<host_name>(config-confd)# end
[local]<host_name># show confdmgr

State Information

State Started
Subscriptions 5
Last successful id 1488-216669-170664
Last failed id None
Username Not configured
Bulkstats Enabled
Event notification level Disabled
SNMP notifications Disabled
REST interface authentication peer-fail
REST interface certificate rest-cert
REST interface host name Not configured

Interface Status Port

NETCONF Enabled 123
REST Enabled 234

```

### Bulkstats Configuration

See below for a sample bulkstats configuration:

```

[local]<host_name># show config bulkstats
config
 bulkstats collection
 bulkstats mode
 file 1
 schema common format %uptime%,%host%,%ipaddr%
 #exit
 file 2
 schema system format %uptime%,%host%,%ipaddr%
 #exit
 #exit
End

```

### Force Bulkstats Collection

See below for a sample to force statistics to be collected and pushed to the operational database for ConfD:

```

[local]<host_name># bulkstats force gather

```

## Notes:

- Statistics will generally be pushed per collection interval timer configured for bulkstats.

### Using Curl to Read Statistics

See below for a sample use of curl to read statistics via the server ConfD RESTful interface:

```
[<user>@server]]$ curl -u admin:pswd!
https://rtp-mitg-si06.cisco.com:234/api/operational/bulkstats-operational?deep --cert
/users/<user>/ssl_cert/client_cert/client.crt --key
/users/<user>/ssl_cert/client_cert/client.key --cacert
/users/<user>/ssl_cert/root_cert/rootCA.pem

<bulkstats-operational xmlns="http://www.cisco.com/staros-bulkstats"
xmlns:y="http://tail-f.com/ns/rest"
xmlns:staros_bulkstats="http://www.cisco.com/staros-bulkstats">
 <file>
 <number>1</number>
 <schemas>
 <schema>system</schema>
 <names>
 <name>common</name>
 <key_ids>
 <key_id>none</key_id>
 <variable>
 <name>host</name>
 <value><host_name></value>
 </variable>
 <variable>
 <name>ipaddr</name>
 <value>1.2.3.4</value>
 </variable>
 <variable>
 <name>uptime</name>
 <value>5781</value>
 </variable>
 </key_ids>
 </names>
 </schemas>
 </file>
 <file>
 <number>2</number>
 <schemas>
 <schema>system</schema>
 <names>
 <name>system</name>
 <key_ids>
 <key_id>none</key_id>
 <variable>
 <name>host</name>
 <value><host_name></value>
 </variable>
 <variable>
 <name>ipaddr</name>
 <value>1.2.3.4</value>
 </variable>
 <variable>
 <name>uptime</name>
 <value>5781</value>
 </variable>
 </key_ids>
 </names>
 </file>
</bulkstats-operational>
```

```

 </schemas>
 </file>
</bulkstats-operational>

```

## Exec CLI Model

The following examples use the Exec CLI model.

### Using Curl to Obtain the 'show version' Output

See below for a sample use of curl to obtain the **show version** output:

```

cat exec_cli_show_version.xml
<input><args>show version</args></input>

[<user>@server]]$ curl -u admin:pswd!
https://rtp-mitg-si06.cisco.com:234/api/running/staros_exec/_operations/exec --cert
/users/<user>/ssl_cert/client_cert/client.crt --key
/users/<user>/ssl_cert/client_cert/client.key --cacert
/users/<user>/ssl_cert/root_cert/rootCA.pem -X POST -T ./exec_cli_show_version.xml
<output xmlns='http://www.cisco.com/staros-exec'>
 <result>Active Software:
 Image Version: 21.2.M0.private
 Image Build Number: private
 Image Description: Developer_Build
 Image Date: Thu Feb 23 15:25:47 EST 2017
 Boot Image: /flash/qvpc-si.bin.confd
 Source Commit ID: bd234043a93c68873ea77444733a8c632356d161
 </result>
</output>

```

### Using Curl to Obtain Multiple Show Command Outputs

See below for a sample use of curl to obtain the **show build** and **show confdmgr** outputs, using "\r\n" as the delimiter between commands:

```

cat exec_cli_show_build_and_confdmgr.xml
<input><args>show build \r\n show confdmgr</args></input>

[<user>@server]]$ curl -u admin:pswd!
https://rtp-mitg-si06.cisco.com:234/api/running/staros_exec/_operations/exec --cert
/users/<user>/ssl_cert/client_cert/client.crt --key
/users/<user>/ssl_cert/client_cert/client.key --cacert
/users/<user>/ssl_cert/root_cert/rootCA.pem -X POST -T ./ exec_cli_show_build_and_confdmgr.xml
<output xmlns='http://www.cisco.com/staros-exec'>
 <result>Active Software:
 Image Version: 21.2.M0.private
 Image Build Number: private
 Image Description: Developer_Build
 Image Date: Thu Feb 23 15:25:47 EST 2017
 Boot Image: /flash/qvpc-si.bin.confd
 Source Commit ID: bd234043a93c68873ea77444733a8c632356d161
 Kernel Version: 2.6.38-staros-v3-ssi-64
 Kernel Machine Type: x86_64

 Build Information:
 Kernel Build: #1 SMP PREEMPT Wed Feb 22 12:28:49 EST 2017
 Image Build Type: Production build
 Image Build User: <user>
 Image Build Machine: <host_name>
 Image Build Changeset Version: +
 Image Build Changeset Author: <user>

```

```

Image Build Changeset Location: cisco.com
Image Build Changeset Number: bd234043a93c68873ea77444733a8c632356d161
Image Build Changeset PID: 2017-02-23

**** Local changes exist ****

State Information

State Started
Subscriptions 5
Last successful id 1488-216669-170664
Last failed id None
Username Not configured
Bulkstats Enabled
Event notification level Disabled
SNMP notifications Disabled
REST interface authentication peer-fail
REST interface certificate rest-cert
REST interface host name Not configured

Interface Status Port

NETCONF Enabled 123
REST Enabled 234

Statistics

Triggers 1
Replays 0
Notifications 27
Notification failures 0
Trigger failures 0
Replay failures 0
NETCONF notification failures 0
Unexpected failures 0
</result>
</output>

```

## ConfD Upgrade Support

### CLI Based YANG Model for ECS Commands

In this release, the **cisco-staros-cli-config.yang** model supports a limited set of ECS (Enhanced Charging System) configuration commands via NSO.

On the southbound side, ConfD communicates with a StarOS process called via a set of APIs provided by the ConfD management agent. The ConfD CDB is used by ConfD to store objects. StarOS accesses the database through the ConfD-supplied APIs. Once the ConfD configuration database is populated, StarOS continues to allow CLI access to modify the overall configuration. There are no automatic updates to the CDB as a result. The CDB only receives updates via the NETCONF interface. In order to keep the CDB and the StarOS configuration databases in sync, all changes made via CLI access (external to NETCONF) to the **cisco-staros-cli-config** YANG model supported configuration objects must be applied to the CDB manually.

## Seeding and Synchronizing the CDB

After enabling **server confd** you may need to initially seed the CDB with a local copy of the configuration database (CDB) managed by ConfD on StarOS. The seeding procedure creates a CDB used by ConfD on the StarOS platform that contains all CLI based YANG model supported configuration commands.



### Important

- If you manually modify a managed object via the StarOS CLI, you must resynchronize the running configuration with the NSO by repeating the procedure described below.

- 
- Step 1** Run Exec mode **save configuration <url> confd** to save the ConfD supported StarOS configuration data to a file on the /flash device.
- Step 2** Run Exec mode **show configuration error** to validate the saved configuration. Correct any errors before applying the configuration. Otherwise, ConfD will reject the entire configuration.
- Step 3** Run Exec mode **configure confd <url>** to apply the ConfD configuration. Once the ConfD configuration is applied, the device is ready to establish NETCONF connections to the NSO management service.
- Step 4** Synchronize the device with your NSO. Refer to NSO user documentation for detailed information on the synchronization process.
- 

## show configuration confd Command

The **confd** keyword filters the output of the **show configuration** command to display only configuration commands that are supported by the CLI based YANG model.

```
show configuration confd
```

A sample output appears below.

```
[local]<host_name># show configuration confd
config
 context local
 server confd
 #exit
 active-charging service ecs
 ruledef rd1
 tcp any-match = TRUE
 #exit
 rulebase default
 #exit
#exit
end
[local]<host_name>#
```

## CDB Maintenance

A local copy of the ConfD Configuration Database (CDB) is managed by ConfD on StarOS.

You can show and save all ConfD supported StarOS configuration commands to a URL. The **confd** keyword has been added to the **show configuration** and **save configuration** commands for these purposes.

After saving a ConfD-supported configuration to a URL, you can apply it directly to the CDB via the Exec mode **configure confd <url>** command. This command applies the contents of the file at the *url* to the running configuration of ConfD.

Additional detail regarding the above commands is provided below.

### clear confdmgr confd cdb

This Exec mode command erases the configuration in the ConfD Configuration Database (CDB) which is used by ConfD to store configuration objects. StarOS accesses the database via ConfD-supplied APIs.



**Note** The CDB cannot be erased unless the Context Configuration mode **no server confd** command is run in the local context to disable ConfD and NETCONF protocol support.

The following is a sample command sequence for clearing the CDB:

```
[local]host_name# config
[local]host_name(config)# context local
[local]host_name(config-ctx)# no server confd
[local]host_name(config-ctx)# end
[local]host_name# clear confdmgr confd cdb
About to delete the ConfD configuration database
The running configuration is NOT affected.
Are you sure? [Yes|No]: y
[local]host_name#
```



**Caution** Clearing the CDB is a terminal operation. The CDB must be repopulated afterwards.

### configure confd <url>

This Exec mode command applies the contents of the configuration script specified by the URL to the current ConfD configuration database (CDB).

A sample command sequence is provided below.

```
[local]host_name# save configuration /flash/confd.config confd
[local]host_name# configure confd /flash/confd.config
Info: #!$$ StarOS V20.2 Chassis 52767e9ff9e207bed12c76f7f8a5352c
Info: config
Info: active-charging service acs
Info: rulebase default
Info: #exit
Info: #exit
Info: end
[local]host_name#
```

## save configuration <url> confd

The keyword **confd** is added to the Exec mode **save configuration** command. This keyword filters the saved configuration commands to contain only configuration commands that are supported by the YANG model.

The command syntax for this process is:

```
[local]host_name# save configuration <url> confd
```

The output of the YANG model subset of configuration commands can be viewed via the **show file url <url>** command, where <url> is the pathname used to save the configuration. The saved configuration file can then be applied to the CDB using the **configure confd** command.

## Supported StarOS ECS Configuration Commands

For this release, the following StarOS ECS commands are supported for the CLI based YANG model:

- ruledef <ruledef\_name>
  - ip server-ip-address = \*
  - tcp-ether-port = \*
  - udp ether-port = \*
  - tcp ether-port-range = \*
  - udp ether-port range = \*
  - tcp-any-match = \*
  - udp any-match = \*
  - http url = \*
  - httpcookie = \*
  - http x-header = \*
- group-of-ruledefs <ruledefs\_group\_name>
  - add-ruledef priority = \*
- qos-group-of-ruledefs <group\_name>
  - add-group-of-ruledef <group\_of\_ruledef\_name>
- charging-action <charging\_action\_name>
  - flow-idle-timeout <seconds>
  - content-id 1
  - service-identifier <service\_id>
  - billing-action egcdr
- rulebase <rulebase\_name>



- action priority *<priority\_number>* group-of-ruledefs *<ruledefs\_group\_name>* charging-action *<charging\_action\_name>*



---

**Note** "= \*" indicates support for every option following the prior keyword/value.

---





## APPENDIX **D**

# ICSR Checkpointing

This appendix lists and describes macro- and micro-checkpoints employed by the Interchassis Session Recovery framework. Checkpoints are exchanged between the active and standby ICSR chassis via the Service Redundancy Protocol (SRP).

The following topics are discussed:

- [Overview of Checkpointing, on page 471](#)
- [Macro-checkpoints, on page 471](#)
- [Micro-checkpoints, on page 473](#)

## Overview of Checkpointing

Interchassis Session Recovery (ICSR) provides a framework for sessmgr instance-level checkpointing within an ICSR framework. A checkpoint is a snapshot of the status of an application. Checkpointing can be used by sessmgr to push instance level information to the peer chassis.

Instance-level checkpointing sends messages to specific sessmgr instances. Each application, such as GGSN, PDSN, P-GW, S-GW or SGSN, is responsible for encoding and decoding the checkpoint message. The ICSR framework provides the APIs for transport of the instance-level checkpoint information and associated statistics.

Macro-checkpoints contain full session information and micro-checkpoints contain only a few variables. Macro-checkpoints are sent initially from the active chassis to the standby chassis on power up and reload, and periodically thereafter. When a standby chassis receives macro-checkpoints, it clears any existing CRR (Call Recovery Record) or CLP (Call Line Pointer) related to that session, and creates a new CRR or CLP. Macro-checkpoints are also known as full checkpoints (FCs).

To conserve processing cycles and memory, dynamic and periodic updates from an active chassis to a standby chassis are done using micro-checkpoints.

The output of the Exec mode **show srp info** command displays a complete list of SRP checkpoints.

## Macro-checkpoints

This section lists and briefly describes ICSR macro-checkpoints.

## GGSN\_APN ID MAPPING

This macro-checkpoint is sent from the active to the standby chassis to map APN names on the standby chassis.

- **Time based:** No
- **Frequency:** N/A
- **Event based:** Yes
- **Events:** Occurs whenever a TCP connection is established between the sessmgrs and they move to READY\_STATE.
- **Accounting:** No
- **Delta/Cumulative:** N/A
- **Related CLI command:** `show session subsystem facility sessmgr instance <instance no> debug-info` and `show srp micro-checkpoint statistics`

## INSTANCE LEVEL CHECKPOINT

This macro-checkpoint is generated by ECS (Enhanced Charging System) to send new rules to the standby chassis. It is also used by ECS to delete or modify a rule on the standby chassis.

- **Time based:** Yes
- **Frequency:** 30 minutes
- **Event based:** Yes
- **Events:** Occurs:
  1. When a new rule is added or deleted on the active chassis.
  2. Every 30 minutes if the ECS is registered for periodic micro-checkpointing.
- **Accounting:** —
- **Delta/Cumulative:** —
- **Related CLI command:** `show session subsystem facility sessmgr instance <instance no> debug-info` and `show srp micro-checkpoint statistics`

## SERVICE\_ID MAPPING

This macro-checkpoint is sent from the active to the standby chassis to map Service IDs on the standby chassis.

- **Time based:** No
- **Frequency:** N/A
- **Event based:** Yes
- **Events:** Occurs whenever a TCP connection is established between the sessmgrs and they move to READY\_STATE.
- **Accounting:** No
- **Delta/Cumulative:** N/A
- **Related CLI command:** `show session subsystem facility sessmgr instance <instance no> debug-info`

## VPNMGR\_ID MAPPING

This macro-checkpoint is sent from the active to the standby chassis to map VPNs on the standby chassis.

- **Time based:** No

- **Frequency:** N/A
- **Event based:** Yes
- **Events:** Occurs whenever a TCP connection is established between the sessmgrs and they move to READY\_STATE.
- **Accounting:** No
- **Delta/Cumulative:** N/A
- **Related CLI command:** `show session subsystem facility sessmgr instance <instance no> debug-info`

## Micro-checkpoints

This section lists and briefly describes the characteristics of micro-checkpoints by application category.

Micro-checkpoints are listed in alphabetical order under the following categories:

- [Uncategorized, on page 473](#)
- [DCCA Category, on page 474](#)
- [ECS Category, on page 474](#)
- [ePDG Category, on page 477](#)
- [Firewall/ECS Category, on page 479](#)
- [GGSN Category, on page 479](#)
- [Gx Interface Category, on page 481](#)
- [NAT Category, on page 481](#)
- [P-GW Category, on page 483](#)
- [Rf Interface Category, on page 485](#)
- [S6b Interface Category, on page 486](#)
- [SaMOG Category, on page 487](#)

## Uncategorized

### SESS\_UCHKPT\_CMD\_INVALIDATE\_CRR

This micro-checkpoint is sent to the standby chassis to clear a deleted call. It carries the Call ID and other information that must be deleted on the standby chassis.

- **Time based:** No
- **Frequency:** N/A
- **Event based:** Yes
- **Events:** Occurs when a call is deleted on the active chassis.
- **Accounting:** No
- **Delta/Cumulative:** N/A
- **CMD-ID:** 1
- **Related CLI command:** None

### SESS\_UCKKPT\_CMD\_UPDATE\_CLPSTATS

This micro-checkpoint sends VoLTE data statistics.

- **Time based:** Yes

- **Frequency:** —
- **Event based:** Yes
- **Events:** Occurs during ICSR background checkpointing. A chassis switchover triggers the sending of VoLTE data stats.
- **Accounting:** —
- **Delta/Cumulative:** —
- **CMD-ID:** 4
- **Related CLI command:** None

## SESS\_UCHKPT\_CMD\_UPDATE\_IDLESECS

This micro-checkpoint sends remaining number of seconds before idle timeout.

- **Time based:** Yes
- **Frequency:** —
- **Event based:** No
- **Events:** Occurs during ICSR background checkpointing.
- **Accounting:** No
- **Delta/Cumulative:** N/A
- **CMD-ID:** 2
- **Related CLI command:** None

## DCCA Category

### SESS\_UCHKPT\_CMD\_DCCA\_SESS\_INFO

This micro-checkpoint sends Credit Control (CC) related information.

- **Time based:** Yes
- **Frequency:** 18 seconds for GR micro-checkpoint
- **Event based:** Yes
- **Events:** Sent along with the macro-checkpoint/CCA/Assume-positive-state-transitions.
- **Accounting:** Yes
- **Delta/Cumulative:** Cumulative
- **CMD-ID:** 19
- **Related CLI command:** None

## ECS Category

### SESS\_UCHKPT\_CMD\_ACS\_CALL\_INFO

This micro-checkpoint sends critical ECS call level data.

- **Time based:** Yes
- **Frequency:** —
- **Event based:** Yes
- **Events:** Occurs whenever ECS call level information is created or modified.
- **Accounting:** No

- **Delta/Cumulative:** N/A
- **CMD-ID:** 179
- **Related CLI command:** None

## SESS\_UCHKPT\_CMD\_ACS\_GX\_LI\_INFO

This micro-checkpoint sources lawful intercept (LI) related information maintained by ECS.

- **Time based:** Yes
- **Frequency:** —
- **Event based:** Yes
- **Events:** Occurs whenever LI information is created or modified.
- **Accounting:** No
- **Delta/Cumulative:** N/A
- **CMD-ID:** 75
- **Related CLI command:** None

## SESS\_UCHKPT\_CMD\_ACS\_SESS\_INFO

This micro-checkpoint sends ECS-level bearer-related data

- **Time based:** Yes
- **Frequency:** —
- **Event based:** Yes
- **Events:** Occurs whenever ECS bearer information is created or modified.
- **Accounting:** No
- **Delta/Cumulative:** N/A
- **CMD-ID:** 33
- **Related CLI command:** None

## SESS\_UCHKPT\_CMD\_DEL\_ACS\_CALL\_INFO

This micro-checkpoint notifies that a Release Call event has occurred.

- **Time based:** No
- **Frequency:** N/A
- **Event based:** Yes
- **Events:** Occurs whenever an ECS Release Call message is processed.
- **Accounting:** No
- **Delta/Cumulative:** N/A
- **CMD-ID:** 188
- **Related CLI command:** —

## SESS\_UCHKPT\_CMD\_DEL\_ACS\_SESS\_INFO

This micro-checkpoint notifies that a Release Bearer event has occurred.

- **Time based:** No
- **Frequency:** N/A
- **Event based:** Yes

- **Events:** Occurs whenever an ECS Release Bearer message is processed.
- **Accounting:** No
- **Delta/Cumulative:** N/A
- **CMD-ID:** 187
- **Related CLI command:** None

## SESS\_UCHKPT\_CMD\_DYNAMIC\_CHRG\_CA\_INFO

This micro-checkpoint sends dynamic charging action information maintained by ECS.

- **Time based:** Yes
- **Frequency:** —
- **Event based:** Yes
- **Events:** Occurs whenever dynamic charging action information is created or modified.
- **Accounting:** No
- **Delta/Cumulative:** N/A
- **CMD-ID:** 141
- **Related CLI command:** None

## SESS\_UCHKPT\_CMD\_DYNAMIC\_CHRG\_DEL\_CA\_INFO

This micro-checkpoint notifies that a dynamic charging action has been deleted.

- **Time based:** No
- **Frequency:** N/A
- **Event based:** Yes
- **Events:** Occurs whenever a dynamic charging action has been deleted.
- **Accounting:** No
- **Delta/Cumulative:** N/A
- **CMD-ID:** 183
- **Related CLI command:** None

## SESS\_UCHKPT\_CMD\_DYNAMIC\_CHRG\_DEL\_QG\_INFO

This micro-checkpoint notifies that a dynamic QoS group has been deleted.

- **Time based:** No
- **Frequency:** N/A
- **Event based:** Yes
- **Events:** Occurs whenever a dynamic QoS group has been deleted.
- **Accounting:** No
- **Delta/Cumulative:** N/A
- **CMD-ID:** 182
- **Related CLI command:** None

## SESS\_UCHKPT\_CMD\_DYNAMIC\_CHRG\_QG\_INFO

This micro-checkpoint sends dynamic QoS group related information maintained by ECS.

- **Time based:** Yes



- **Frequency:** —
- **Event based:** Yes
- **Events:** Occurs whenever dynamic QoS group information is created or modified.
- **Accounting:** No
- **Delta/Cumulative:** N/A
- **CMD-ID:** 140
- **Related CLI command:** None

## SESS\_UCHKPT\_CMD\_DYNAMIC\_RULE\_DEL\_INFO

This micro-checkpoint notifies that a dynamic rule has been deleted.

- **Time based:** No
- **Frequency:** —
- **Event based:** Yes
- **Events:** Occurs whenever a dynamic rule has been deleted.
- **Accounting:** No
- **Delta/Cumulative:** N/A
- **CMD-ID:** 178
- **Related CLI command:** None

## SESS\_UCHKPT\_CMD\_DYNAMIC\_RULE\_INFO

This micro-checkpoint sources predefined and dynamic rule related information maintained by ECS.

- **Time based:** Yes
- **Frequency:** —
- **Event based:** Yes
- **Events:** Occurs whenever a dynamic rule is created or modified.
- **Accounting:** No
- **Delta/Cumulative:** N/A
- **CMD-ID:** 43
- **Related CLI command:** None

## ePDG Category

### SESS\_UCHKPT\_CMD\_DELETE\_EPDG\_BEARER

This micro-checkpoint synchronizes deleted ePDG bearers between the active and standby chassis.

- **Time based:** No
- **Frequency:** N/A
- **Event based:** Yes
- **Events:** N/A
- **Accounting:** Yes
- **Delta/Cumulative:** Cumulative
- **CMD-ID:** 110
- **Related CLI command:** `show srp micro-checkpoint statistics debug-info`

## SESS\_UCHKPT\_CMD\_UPDATE\_EPDG\_BEARER

This micro-checkpoint synchronizes ePDG bearers between the active and standby chassis.

- **Time based:** No
- **Frequency:** N/A
- **Event based:** No
- **Events:** N/A
- **Accounting:** Yes
- **Delta/Cumulative:** Cumulative
- **CMD-ID:** 110
- **Related CLI command:** `show srp micro-checkpoint statistics debug-info`

## SESS\_UCHKPT\_CMD\_UPDATE\_EPDG\_PEER\_ADDR

This micro-checkpoint synchronizes ePDG peer addresses between the active and standby chassis.

- **Time based:** No
- **Frequency:** N/A
- **Event based:** Yes
- **Events:** —
- **Accounting:** Yes
- **Delta/Cumulative:** Cumulative
- **CMD-ID:** 110
- **Related CLI command:** `show srp micro-checkpoint statistics debug-info`

## SESS\_UCHKPT\_CMD\_UPDATE\_EPDG\_REKEY

This micro-checkpoint synchronizes ePDG rekey statistics between the active and standby chassis.

- **Time based:** Yes
- **Frequency:** 30 seconds
- **Event based:** No
- **Events:** N/A
- **Accounting:** Yes
- **Delta/Cumulative:** Cumulative
- **CMD-ID:** 110
- **Related CLI command:** `show srp micro-checkpoint statistics debug-info`

## SESS\_UCHKPT\_CMD\_UPDATE\_EPDG\_STATS

This micro-checkpoint synchronizes session statistics between the active and standby chassis.

- **Time based:** Yes
- **Frequency:** 30 seconds
- **Event based:** No
- **Events:** N/A
- **Accounting:** Yes
- **Delta/Cumulative:** Cumulative
- **CMD-ID:** 110

- **Related CLI command:** show srp micro-checkpoint statistics debug-info

## Firewall/ECS Category

### SESS\_UCHKPT\_CMD\_SFW\_DEL\_RULE\_INFO

This micro-checkpoint is sent when a ruledef is deleted for a bearer.

- **Time based:** No
- **Frequency:** N/A
- **Event based:** Yes
- **Events:** Occurs whenever PCRF sends a command to disable the predefined stateful firewall access rules.
- **Accounting:** No
- **Delta/Cumulative:** N/A
- **CMD-ID:** 186
- **Related CLI command:** None

### SESS\_UCHKPT\_CMD\_SFW\_RULE\_INFO

This micro-checkpoint notifies the addition of dynamically enabled stateful firewall (SFW) access rules.

- **Time based:** No
- **Frequency:** N/A
- **Event based:** Yes
- **Events:** Occurs whenever PCRF sends a command to enable the predefined SFW access rules.
- **Accounting:** Yes
- **Delta/Cumulative:** Cumulative
- **CMD-ID:** 185
- **Related CLI command:** None

## GGSN Category

### SESS\_UCHKPT\_CMD\_GGSN\_DELETE\_SUB\_SESS

This micro-checkpoint sends an update when a secondary bearer is deleted.

- **Time based:** No
- **Frequency:** N/A
- **Event based:** Yes
- **Events:** Occurs upon secondary bearer deletion
- **Accounting:** —
- **Delta/Cumulative:** —
- **CMD-ID:** 117
- **Related CLI command:** None

## SESS\_UCHKPT\_CMD\_GGSN\_UPDATE\_RPR

If RPR (Resilient Packet Ring) is configured in the GGSN service, an RPR timer is started during secondary bearer creation. This checkpoint is sent upon expiry of this timer.

- **Time based:** Yes
- **Frequency:** RPR timer
- **Event based:** Yes
- **Events:** Occurs when the secondary bearer creation RPR timer expires.
- **Accounting:** —
- **Delta/Cumulative:** —
- **CMD-ID:** 118
- **Related CLI command:** —

## SESS\_UCHKPT\_CMD\_GGSN\_UPDATE\_SESSION

This micro-checkpoint is sent in a Network or UE initiated update procedure except for updates that result in the following scenarios:

- Creation or deletion of the beare
- TFT change or inter-RAT handovers
- Gn-Gp handoff

Parameters associated with this micro-checkpoint are shown below.

- **Time based:** No
- **Frequency:** N/A
- **Event based:** Yes
- **Events:** Occurs for a network initiated or UE initiated update.
- **Accounting:** No
- **Delta/Cumulative:** N/A
- **CMD-ID:** 171
- **Related CLI command:** `show srp checkpoint statistics active verbose`, and `show session subsystem facility sessmgr instance <instance_number> debug-info`.

## SESS\_UCHKPT\_CMD\_GGSN\_UPDATE\_STATS

This micro-checkpoint periodically sends session statistics.

- **Time based:** Yes
- **Frequency:** Every five minutes
- **Event based:** No
- **Events:** N/A
- **Accounting:** Yes
- **Delta/Cumulative:** Cumulative
- **CMD-ID:** 116
- **Related CLI command:** None

## SESS\_UCHKPT\_CMD\_UPDATE\_COA\_PARAMS

This micro-checkpoint updates input and output ACL parameters.

- **Time based:** —
- **Frequency:** —
- **Event based:** Yes
- **Events:** COA (Change of Authorization) response
- **Accounting:** —
- **Delta/Cumulative:** —
- **CMD-ID:** 83
- **Related CLI command:** None

## Gx Interface Category

### SESS\_UCHKPT\_CMD\_ACS\_VOLUME\_USAGE

This micro-checkpoint sends volume usage over Gx accounting buckets.

- **Time based:** Yes
- **Frequency:** 4 seconds for aamgr micro-checkpoint and 18 seconds for GR micro-checkpoint
- **Event based:** No
- **Events:** Send along with macro-checkpoint
- **Accounting:** Yes
- **Delta/Cumulative:** Cumulative
- **CMD-ID:** 79
- **Related CLI command:** —None

### SESS\_UCHKPT\_CMD\_UPDATE\_SGX\_INFO

This micro-checkpoint sends Gx session-related information.

- **Time based:** No
- **Frequency:** N/A
- **Event based:** Yes
- **Events:** Triggered on receiving CCA-I/U or RAR from PCRF.
- **Accounting:** Yes
- **Delta/Cumulative:** Cumulative
- **CMD-ID:** 137
- **Related CLI command:** None

## NAT Category

### SESS\_UCHKPT\_CMD\_GR\_UPDATE\_NAT\_REALM\_PORT\_INF01

This micro-checkpoint is sent when a port chunk is allocated or deallocated for a subscriber sharing a NAT IP address with other subscribers. The port chunk is allocated or deallocated while data is being received for that subscriber.

- **Time based:** No
- **Frequency:** N/A
- **Event based:** Yes

- **Events:** Triggered when a new NAT port chunk is allocated or deleted.
- **Accounting:** No
- **Delta/Cumulative:** N/A
- **CMD-ID:** 105
- **Related CLI command:** None

## SESS\_UCHKPT\_CMD\_GR\_UPDATE\_NAT\_REALMS

This micro-checkpoint is sent when a NAT IP address is allocated to or deallocated from a subscriber.

For an on-demand case, it is triggered when the first packet matching a particular NAT realm is received and the NAT IP address is allocated to the subscriber.

If this is not an on-demand case, the NAT IP address is allocated during call setup and this micro-checkpoint is sent.

- **Time based:** No
- **Frequency:** N/A
- **Event based:** Yes
- **Events:** Triggered when a NAT IP address is allocated to or deallocated from a subscriber.
- **Accounting:** No
- **Delta/Cumulative:** N/A
- **CMD-ID:** 45
- **Related CLI command:** None

## SESS\_UCHKPT\_CMD\_NAT\_SIP\_ALG\_CALL\_INFO

This micro-checkpoint is sent when a new SIP flow is created or deleted for a subscriber (while SIP data is being passed via the subscriber).

- **Time based:** No
- **Frequency:** N/A
- **Event based:** Yes
- **Events:** Triggered when a new SIP flow is created or deleted.
- **Accounting:** No
- **Delta/Cumulative:** N/A
- **CMD-ID:** 98
- **Related CLI command:** None

## SESS\_UCHKPT\_CMD\_NAT\_SIP\_ALG\_CONTACT\_PH\_INFO

This micro-checkpoint is sent when a received SIP packet is analyzed and pinholes are created in the NAT firewall.

- **Time based:** No
- **Frequency:** N/A
- **Event based:** Yes
- **Events:** Triggered when a SIP packet creates pinholes in the NAT firewall.
- **Accounting:** No
- **Delta/Cumulative:** N/A
- **CMD-ID:** 97

- **Related CLI command:** None

## SESS\_UCHKPT\_CMD\_UPDATE\_DSK\_FLOW\_CHKPT\_INFO

This micro-checkpoint is sent when a new NAT flow is created or deleted for a subscriber (while data is being passed via the subscriber).

This checkpoint is sent from a timer but it is not timer based. The timer is used to pace (10 micro-checkpoints) whenever the timer fires (granularity = 2 sec). This only occurs if there are new flows that need to be micro-checkpointed. Otherwise, no micro-checkpoints are sent.

- **Time based:** No
- **Frequency:** See explanation above.
- **Event based:** Yes
- **Events:** Triggered when a new NAT flow is created or deleted.
- **Accounting:** No
- **Delta/Cumulative:** N/A
- **CMD-ID:** 96
- **Related CLI command:** None

## SESS\_UCHKPT\_CMD\_UPDATE\_NAT\_BYPASS\_FLOW\_INFO

This micro-checkpoint is sent when NAT is enabled for a subscriber but bypass-nat (no NATing) is configured for this flow (based on a rule-match), and a new bypass flow is created.

This checkpoint is sent when the flow is both added and deleted.

- **Time based:** No
- **Frequency:** N/A
- **Event based:** Yes
- **Events:** Triggered when a new flow with bypass-nat enabled is created or deleted.
- **Accounting:** No
- **Delta/Cumulative:** N/A
- **CMD-ID:** 60
- **Related CLI command:** None

## P-GW Category

### SESS\_UCHKPT\_CMD\_PGW\_DELETE\_SUB\_SESS

Reserved for future use.

### SESS\_UCHKPT\_CMD\_PGW\_OVRCHRG\_PRTCTN\_INFO

This micro-checkpoint indicates that the S-GW has set the Overcharging Protection bit in the MBR.

- **Time based:** No
- **Frequency:** N/A
- **Event based:** Yes
- **Events:** Triggered when the S-GW sets the Over Charging Protection Bit.
- **Accounting:** No

- **Delta/Cumulative:** N/A
- **CMD-ID:** 159
- **Related CLI command:** None

## SESS\_UCHKPT\_CMD\_PGW\_SGWRESTORATION\_INFO

This micro-checkpoint indicates the interval that a call will remain up when the S-GW is down.

- **Time based:** No
- **Frequency:** N/A
- **Event based:** Yes
- **Events:** Triggered when the S-GW goes into Restoration mode.
- **Accounting:** No
- **Delta/Cumulative:** N/A
- **CMD-ID:** 158
- **Related CLI command:** None

## SESS\_UCHKPT\_CMD\_PGW\_UBR\_MBR\_INFO

This micro-checkpoint is sent at the end of a UBR (Update Bearer Request ) or MBR (Modify Bearer Request ) except when the UBR /MBR procedure results in the following scenarios:

- TFT change
- Bearer updat or modification for a collapsed call
- Pure P to collapsed or collapsed to Pure P change
- Inter-technology handoff, for example, WiFi to LTE

Parameters associated with this micro-checkpoint are show below.

- **Time based:** No
- **Frequency:** N/A
- **Event based:** yes
- **Events:** Occurs as a result of a UBR or MBR procedure.
- **Accounting:** No
- **Delta/Cumulative:** N/A
- **CMD-ID:** 193
- **Related CLI command:** `show srp checkpoint statistics active verbose` and `show session subsystem facility sessmgr instance <instance_number> debug-info`.

## SESS\_UCHKPT\_CMD\_PGW\_UPDATE\_APN\_AMBR

Reserved for future use.

## SESS\_UCHKPT\_CMD\_PGW\_UPDATE\_INFO

Reserved for future use.

## SESS\_UCHKPT\_CMD\_PGW\_UPDATE\_LI\_PARAM

This micro-checkpoint indicates the state of Lawful Intercept (LI) for this call.

- **Time based:** No



- **Frequency:** N/A
- **Event based:** Yes
- **Events:** Triggered when there is a change in the LI state for this call.
- **Accounting:** No
- **Delta/Cumulative:** N/A
- **CMD-ID:** 151
- **Related CLI command:** None

## SESS\_UCHKPT\_CMD\_PGW\_UPDATE\_PDN\_COMMON\_PARAM

Reserved for future use.

## SESS\_UCHKPT\_CMD\_PGW\_UPDATE\_QOS

Reserved for future use.

## SESS\_UCHKPT\_CMD\_PGW\_UPDATE\_SGW\_CHANGE

Reserved for future use.

## SESS\_UCHKPT\_CMD\_PGW\_UPDATE\_STATS

This micro-checkpoint periodically sends session statistics.

- **Time based:** Yes
- **Frequency:** Every five minutes
- **Event based:** No
- **Events:** N/A
- **Accounting:** Yes
- **Delta/Cumulative:** Cumulative
- **CMD-ID:** 65
- **Related CLI command:** None

## Rf Interface Category

### SESS\_UCHKPT\_CMD\_ACS\_ACCOUNTING\_TYPE\_QCI\_RF

This micro-checkpoint indicates a change in the SDF+QCI-based Rf accounting buckets.

- **Time based:** Yes
- **Frequency:** 4 seconds for aamgr checkpoint and 18 seconds for GR checkpoint
- **Event based:** No
- **Events:** N/A
- **Accounting:** Yes
- **Delta/Cumulative:** Cumulative
- **CMD-ID:** 126
- **Related CLI command:** None

## SESS\_UCHKPT\_CMD\_ACS\_ACCOUNTING\_TYPE\_QCI\_RF\_WITH\_FC

This micro-checkpoint indicates complete SDF+QCI-based Rf accounting buckets.

- **Time based:** Yes
- **Frequency:** 4 seconds for aamgr checkpoint and 18 seconds for GR checkpoint
- **Event based:** No
- **Events:** Sent along with macro-checkpoint.
- **Accounting:** Yes
- **Delta/Cumulative:** Cumulative
- **CMD-ID:** 164
- **Related CLI command:** None

## SESS\_UCHKPT\_CMD\_ACS\_ACCOUNTING\_TYPE\_RATING\_GROUP\_RF

This micro-checkpoint indicates a change in the SDF-based Rf accounting buckets.

- **Time based:** Yes
- **Frequency:** 4 seconds for aamgr checkpoint and 18 seconds for GR checkpoint
- **Event based:** No
- **Events:** N/A
- **Accounting:** Yes
- **Delta/Cumulative:** Cumulative
- **CMD-ID:** 125
- **Related CLI command:** None

## SESS\_UCHKPT\_CMD\_ACS\_ACCOUNTING\_TYPE\_RATING\_GROUP\_RF\_WITH\_FC

This micro-checkpoint indicates complete SDF-based Rf accounting buckets.

- **Time based:** Yes
- **Frequency:** 4 seconds for aamgr checkpoint and 18 seconds for GR checkpoint;
- **Event based:** No
- **Events:** Sent along with macro-checkpoint.
- **Accounting:** Yes
- **Delta/Cumulative:** Cumulative
- **CMD-ID:** 163
- **Related CLI command:** None

## S6b Interface Category

### SESS\_UCHKPT\_CMD\_S6B\_INFO

This micro-checkpoint sends the Restoration Priority Indicator when reauthorization occurs over the S6b interface.

- **Time based:** No
- **Frequency:** N/A
- **Event based:** Yes

- **Events:** Occurs when an Sb6 reauthorization results in a change in value of the Restoration Priority Indicator.
- **Accounting:** No
- **Delta/Cumulative:** N/A
- **CMD-ID:** 202
- **Related CLI command:** None

## SaMOG Category

### SESS\_UCHKPT\_CMD\_CGW\_DELETE\_BEARER

Reserved for future use.

### SESS\_UCHKPT\_CMD\_CGW\_DELETE\_PDN

This micro-checkpoint indicates a PDN connection has been deleted.

- **Time based:** No
- **Frequency:** N/A
- **Event based:** Yes
- **Events:** Occurs whenever SaMOG sends a Delete-Session-Req or upon receiving a Delete-Bearer-Request.
- **Accounting:** No
- **Delta/Cumulative:** N/A
- **CMD-ID:** 169
- **Related CLI command:** `show subscriber samog-only full`

### SESS\_UCHKPT\_CMD\_CGW\_UPDATE\_BEARER\_QOS

This micro-checkpoint indicates a QoS update for the bearer.

- **Time based:** No
- **Frequency:** N/A
- **Event based:** Yes
- **Events:** Occurs when a change in Bearer QoS is received from the P-GW due to a reauthorization (AAR Received from AAA Server) or Update-Bearer-Request.
- **Accounting:** No
- **Delta/Cumulative:** N/A
- **CMD-ID:** 167
- **Related CLI command:** `show subscriber samog-only full`

### SESS\_UCHKPT\_CMD\_CGW\_UPDATE\_PDN

This micro-checkpoint indicates a PDN update for a change in APN-AMBR.

- **Time based:** No
- **Frequency:** N/A
- **Event based:** Yes
- **Events:** Occurs when a change in APN-AMBR is received from the P-GW due to a reauthorization (AAR Received from AAA Server) or Update-Bearer-Request.

- **Accounting:** No
- **Delta/Cumulative:** N/A
- **CMD-ID:** 168
- **Related CLI command:** show subscriber samog-only full

## SESS\_UCHKPT\_CMD\_CGW\_UPDATE\_STATS

Reserved for future use.

## SESS\_UCHKPT\_CMD\_CGW\_UPDATE\_UE\_PARAM

Reserved for future use.

## SESS\_UCHKPT\_CMD\_SAMOG\_ACCT\_INTERIM\_INFO

This micro-checkpoint is sent for a SaMOG session on receipt of an Accounting Req (INTERIM-UPDATE) from the WLC

- **Time based:** No
- **Frequency:** N/A
- **Event based:** Yes
- **Events:** Occurs on receipt of an Accounting Req (INTERIM-UPDATE) from the WLC.
- **Accounting:** No
- **Delta/Cumulative:** N/A
- **CMD-ID:** 177
- **Related CLI command:** show subscriber samog-only full

## SESS\_UCHKPT\_CMD\_SAMOG\_ACCT\_START\_INFO

This micro-checkpoint is sent for a SaMOG session on receipt of an Accounting Req (START) from the WLC (Wireless LAN Controller).

- **Time based:** No
- **Frequency:** N/A
- **Event based:** Yes
- **Events:** Occurs when a Account Req (START) request is received from the WLC.
- **Accounting:** No
- **Delta/Cumulative:** N/A
- **CMD-ID:** 174
- **Related CLI command:** show subscriber samog-only full

## SESS\_UCHKPT\_CMD\_SAMOG\_EOGRE\_TUNNEL\_INFO

This micro-checkpoint is sent for an Inter-RG handoff for EoGRE subscriber sessions. This checkpoint updates the VMAC Address and WLC EoGRE tunnel end-point address.

- **Time based:** No
- **Frequency:** N/A
- **Event based:** Yes
- **Events:** Occurs whenever a DHCP-Discover message is received over a different EoGRE tunnel.
- **Accounting:** No

- **Delta/Cumulative:** N/A
- **CMD-ID:** 201
- **Related CLI command:** show subscriber samog-only full

## SESS\_UCHKPT\_CMD\_SAMOG\_GTPV1\_UPDATE\_PDN\_INFO

This micro-checkpoint is sent for a SaMOG session upon receipt of an Update-PDP-Context-Req from the GGSN to update the PDN information.

- **Time based:** No
- **Frequency:** N/A
- **Event based:** Yes
- **Events:** Occurs after successful SaMOG processing of an Update-PDP-Context-Req from the GGSN.
- **Accounting:** No
- **Delta/Cumulative:** N/A
- **CMD-ID:** 191
- **Related CLI command:** show subscriber samog-only full

## SESS\_UCHKPT\_CMD\_SAMOG\_HANDOFF\_AUTHEN\_INFO

This micro-checkpoint is sent for a SaMOG session that is Re-authenticating the subscriber while the subscriber session is in Handoff state.

- **Time based:** No
- **Frequency:** N/A
- **Event based:** Yes
- **Events:** Occurs on completion of Re-Authentication for an existing SaMOG subscriber session currently in Handoff state.
- **Accounting:** No
- **Delta/Cumulative:** N/A
- **CMD-ID:** 176
- **Related CLI command:** show subscriber samog-only full

## SESS\_UCHKPT\_CMD\_SAMOG\_HANDOFF\_INIT\_INFO

This micro-checkpoint is sent for a SaMOG session on receipt of an Accounting Req (STOP) from the WLC (Wireless LAN Controller).

SaMOG will delay handoff as it expects an Accounting Req (START) from the subscriber.

- **Time based:** No
- **Frequency:** N/A
- **Event based:** Yes
- **Events:** Occurs when a Account Req (STOP) request is received from the WLC.
- **Accounting:** No
- **Delta/Cumulative:** N/A
- **CMD-ID:** 175
- **Related CLI command:** show subscriber samog-only full

## SESS\_UCHKPT\_CMD\_SAMOG\_LI\_PROV\_INFO

This micro-checkpoint is sent for a SaMOG session that is on lawful intercept (LI) Active-Camp-on mode.

- **Time based:** No
- **Frequency:** N/A
- **Event based:** Yes
- **Events:** Occurs after an LI trigger is received after SaMOG session has been created.
- **Accounting:** No
- **Delta/Cumulative:** N/A
- **CMD-ID:** 189
- **Related CLI command:** show subscriber samog-only full

## SESS\_UCHKPT\_CMD\_SAMOG\_MIPV6\_TIMER\_INFO

This micro-checkpoint updates the Binding Cache Life timer and MIPv6 biding status for a SaMOG session.

- **Time based:** No
- **Frequency:** N/A
- **Event based:** Yes
- **Events:** Occurs whenever a PMIPv6 PBU is received with a lifetime of zero from the WLC.
- **Accounting:** No
- **Delta/Cumulative:** N/A
- **CMD-ID:** 190
- **Related CLI command:** show subscriber samog-only full

## SESS\_UCHKPT\_CMD\_SAMOG\_MULTI\_ROUND\_AUTHEN\_INFO

This micro-checkpoint is sent for a SaMOG session when SaMOG is waiting on the UE after sending an Access-Challenge while Re-authenticating the subscriber session.

- **Time based:** No
- **Frequency:** N/A
- **Event based:** Yes
- **Events:** Occurs after SaMOG sends an Access-Challenge for an existing SaMOG subscriber session during Re-authentication.
- **Accounting:** No
- **Delta/Cumulative:** N/A
- **CMD-ID:** 184
- **Related CLI command:** show subscriber samog-only full

## SESS\_UCHKPT\_CMD\_SAMOG\_REAUTHEN\_INFO

This micro-checkpoint is sent for a SaMOG session when subscriber Re-authentication is completed.

- **Time based:** No
- **Frequency:** N/A
- **Event based:** Yes
- **Events:** Occurs on completion of Re-Authentication for an existing SaMOG subscriber session.
- **Accounting:** No

- **Delta/Cumulative:** N/A
- **CMD-ID:** 172
- **Related CLI command:** show subscriber samog-only full

## SESS\_UCHKPT\_CMD\_SAMOG\_REAUTHOR\_INFO

This micro-checkpoint is sent for a SaMOG session when subscriber Re-authorization is completed.

- **Time based:** No
- **Frequency:** N/A
- **Event based:** Yes
- **Events:** Occurs on receiving and successfully processing AAR from the AAA Server to re-authorize the subscriber
- **Accounting:** No
- **Delta/Cumulative:** N/A
- **CMD-ID:** 173
- **Related CLI command:** show subscriber samog-only full







## APPENDIX E

# ASR 5500 SDR CLI Command Strings

- [ASR 5500 SDR CLI Command Strings, on page 493](#)

## ASR 5500 SDR CLI Command Strings

This appendix identifies the CLI command strings that can be entered for a record section via the **support record section** command in the Global Configuration Mode. The string must be entered within double quotation marks (" ") to be recognized. The table below also indicates default and non-default strings.

For detailed command string information, refer to the *Command Line Interface Reference* or the online Help for the command.

The table below also indicates default and non-default strings. It reflects the output sequence of the **show support collection definitions** command.

**Table 54: ASR 5500 SDR CLI Command Strings**

No.	Default SDR	Command String
0	Enabled	"show version verbose"
1	Enabled	"show clock"
2	Enabled	"show clock universal"
3	Enabled	"show configuration"
4	Enabled	"show_profile"
5	Enabled	"show context"
6	Enabled	"show boot"
7	Enabled	"show boot initial-config"
8	Enabled	"show system uptime"
9	Disabled	"show license information"
10	Disabled	"show license history"
11	Disabled	"show hardware inventory"
12	Disabled	"show hardware version"

No.	Default SDR	Command String
13	Disabled	"show card hardware"
14	Disabled	"show card dhaccel hardware counters"
15	Enabled	"show hd raid verbose"
16	Enabled	"debug hdctrl mdstat"
17	Enabled	"debug hdctrl history"
18	Disabled	"debug hdctrl lssas"
19	Disabled	"debug hdctrl mapping"
20	Enabled	"show hd iocont all"
21	Disabled	"show hd logs all"
22	Enabled	"show hd smart all"
23	Enabled	"debug hdctrl state"
24	Enabled	"debug hdctrl client list"
25	Disabled	"show card info"
26	Enabled	"show card diag"
27	Enabled	"show card table all"
28	Enabled	"show port table all"
29	Enabled	"show port info"
30	Enabled	"show port utilization table"
31	Enabled	"show data-path congestion"
32	Disabled	"show npu details"
33	Disabled	"show lagmgr details"
34	Enabled	"show fans"
35	Disabled	"show hardware version fans"
36	Enabled	"show power chassis"
37	Enabled	"show temperature"
38	Disabled	"show timing"
39	Disabled	"show alarm audible"
40	Disabled	"show alarm central-office"
41	Disabled	"show alarm outstanding"
42	Disabled	"show alarm statistics"
43	Enabled	"show cpu table"
44	Disabled	"show cpu info verbose"

No.	Default SDR	Command String
45	Enabled	"show cpu errors verbose"
46	Enabled	"show cpu performance verbose"
47	Disabled	"show resources"
48	Disabled	"show task table"
49	Disabled	"show task memory"
50	Disabled	"show task memory max"
51	Disabled	"show task resources"
52	Disabled	"show task resources max"
53	Enabled	"show crash list"
54	Enabled	"show crash all"
55	Disabled	"show persistdump list"
56	Disabled	"show persistdump display"
57	Enabled	"show snmp trap history verbose"
58	Disabled	"show snmp trap statistics verbose"
59	Enabled	"show logs"
63	Disabled	"show messenger settings"
64	Enabled	"show messenger nameservice"
65	Enabled	"show messenger statistics"
66	Enabled	"show messenger bounces"
67	Disabled	"debug limits checkup detailed"
68	Disabled	"show plugin"
69	Disabled	"show module"
70	Disabled	"show ppp statistics"
71	Disabled	"show rsvp statistics"
72	Enabled	"show session disconnect-reasons verbose"
73	Disabled	"show apn statistics all"
74	Disabled	"show ipsg statistics"
75	Disabled	"show pdsn-service all"
76	Disabled	"show hsgw-service all"
77	Disabled	"show hsgw-service statistics all"
78	Disabled	"show epdg-service all counters"
79	Disabled	"show epdg-service statistics"

No.	Default SDR	Command String
80	Disabled	"show fa-service all"
81	Disabled	"show ha-service all"
82	Disabled	"show mag-service all"
83	Disabled	"show mipv6ha-service all"
84	Disabled	"show lma-service all"
85	Disabled	"show dhcp-service all"
86	Disabled	"show sgsn-service all"
87	Disabled	"show sgsn sessmgr all memory statistics"
88	Disabled	"show operator-policy all"
89	Disabled	"show call-control-profile all"
90	Disabled	"show apn-profile all"
91	Disabled	"show imei-profile all"
92	Disabled	"show gprs-service all"
93	Disabled	"show iups-service all"
94	Disabled	"show sgtp-service all"
95	Disabled	"show map-service all"
96	Disabled	"show gs-service all"
97	Disabled	"show ggsn-service all"
98	Disabled	"show ggsn-service sgsn-table"
105	Disabled	"show lac-service all"
106	Disabled	"show lns-service all"
107	Disabled	"show pdnclosedrp-service all"
108	Enabled	"show subscriber summary"
109	Enabled	"show connproxy sockets all"
110	Disabled	"show session progress"
111	Disabled	"show session subsystem data-info verbose"
112	Disabled	"show session subsystem full data-info"
113	Disabled	"show session subsystem facility sessmgr all debug-info"
114	Disabled	"show sessctrl config-reconciliation statistics"
115	Disabled	"show rp statistics"
116	Disabled	"show mipfa statistics"

No.	Default SDR	Command String
117	Disabled	"show mipha statistics"
118	Disabled	"show mipv6ha statistics"
119	Disabled	"show lma-service statistics"
120	Disabled	"show mag-service statistics"
121	Disabled	"show cli configuration-monitor"
122	Enabled	"show srp info"
123	Enabled	"show srp checkpoint statistics"
124	Disabled	"show srp checkpoint statistics verbose"
125	Disabled	"show srp checkpoint statistics sessmgr all"
126	Disabled	"show srp checkpoint statistics ipsecmgr all"
127	Enabled	"show srp checkpoint statistics sessmgr all write-list-stats"
128	Disabled	"show srp monitor"
129	Enabled	"show srp monitor all"
130	Disabled	"show srp monitor diameter debug"
131	Enabled	"show srp statistics"
132	Disabled	"show srp call-loss statistics"
133	Disabled	"show srp audit-statistics"
134	Disabled	"show gtpc statistics verbose"
135	Enabled	"show gtpu statistics verbose"
136	Enabled	"show gtpu debug-info"
137	Enabled	"show gmm-sm statistics verbose"
138	Enabled	"show sgtpc statistics verbose"
139	Enabled	"show sgtpu statistics"
140	Disabled	"show ss7-routing-domain all sctp asp all status peer-server all peer-server-process all verbose"
141	Enabled	"show ss7-routing-domain all sctp asp all statistics gen"
142	Disabled	"show ss7-routing-domain all m3ua status peer-server all"
143	Disabled	"show ss7-routing-domain all m3ua statistics peer-server all peer-server-process all"

No.	Default SDR	Command String
144	Disabled	"show ss7-routing-domain all qsaal statistics linkset all link all"
145	Disabled	"show ss7-routing-domain all sscf statistics linkset all link all"
146	Disabled	"show ss7-routing-domain all mtp3 status linkset all link all"
147	Disabled	"show ss7-routing-domain all mtp3 statistics gen"
148	Disabled	"show ss7-routing-domain all mtp3 statistics linkset all link all"
149	Disabled	"show ss7-routing-domain all routes"
150	Disabled	"show sccp-network all status all"
151	Disabled	"show global-title-translation association"
152	Disabled	"show global-title-translation address-map"
153	Enabled	"show egtpc peers"
154	Disabled	"show egtpc statistics interface mme"
155	Enabled	"show egtpc statistics interface sgsn"
156	Enabled	"show egtpc statistics interface sgw-ingress"
157	Enabled	"show egtpc statistics interface sgw-egress"
158	Enabled	"show egtpc statistics interface pgw-ingress"
159	Enabled	"show egtpc statistics interface cgw-egress"
160	Enabled	"show egtpc statistics interface epdg-egress"
161	Disabled	"show egt-service all"
162	Disabled	"show gtpu-service all"
163	Disabled	"show pgw-service all"
164	Disabled	"show sgw-service all"
165	Disabled	"show saegw-service all"
166	Disabled	"show henbgw-access-service statistics"
167	Disabled	"show henbgw-network-service statistics"
168	Disabled	"show mme-service all"
169	Disabled	"show mme-service enodeb-association full all"

No.	Default SDR	Command String
170	Disabled	"show mme-service statistics debug"
171	Disabled	"show mme-service db statistics"
172	Disabled	"show sgs-service all"
173	Disabled	"show sgs-service vlr-status full"
174	Disabled	"show sgs-service statistics all"
175	Enabled	"show sgw-service statistics all"
176	Disabled	"show saegw-service statistics all verbose"
177	Disabled	"show saegw-service statistics all function sgw verbose"
178	Disabled	"show saegw-service statistics all function pgw verbose"
179	Enabled	"show pgw-service statistics all"
180	Disabled	"show sccp statistics"
181	Disabled	"show tcp statistics"
182	Disabled	"show map statistics"
183	Disabled	"show sms statistics"
184	Disabled	"show pdg-service statistics"
185	Disabled	"show hnbgw sessmgr all memory statistics"
186	Disabled	"show hnbgw sessmgr all internal statistics"
187	Disabled	"show hnbgw disconnect-reasons"
188	Disabled	"show cs-network statistics"
189	Disabled	"show ps-network statistics"
190	Disabled	"show hnbgw statistics"
191	Disabled	"show hnbgw counters"
192	Disabled	"show demux-mgr statistics hnbmgr full"
193	Disabled	"show demuxmgr statistics bngmgr all"
194	Disabled	"show alcap statistics"
195	Disabled	"show pdg-service statistics micro-tunnel"
196	Disabled	"show pdg-service statistics transport"
197	Disabled	"show demuxmgr statistics allmgr all"
198	Disabled	"show demuxmgr statistics famgr all"
199	Disabled	"show demuxmgr statistics hamgr all"

No.	Default SDR	Command String
200	Disabled	"show demuxmgr statistics l2tpmgr all"
201	Disabled	"show demuxmgr statistics ipsgmgr all"
202	Enabled	"show demuxmgr statistics sgtpcmgr all"
203	Disabled	"show demuxmgr statistics imsimgr all"
204	Enabled	"show demuxmgr statistics gtpcmgr all"
205	Enabled	"show demuxmgr statistics egtpinmgr all"
206	Disabled	"show demuxmgr statistics egtpegmgr all"
207	Disabled	"show demuxmgr statistics pdgdmgr all"
208	Enabled	"show demuxmgr statistics gtpumgr all"
209	Disabled	"show bcmcs statistics all"
210	Enabled	"show linkmgr all parser statistics all"
211	Disabled	"show gtp accounting servers"
212	Disabled	"show gtp statistics verbose"
213	Disabled	"show gtp counters all"
214	Disabled	"show gtp storage-server"
215	Disabled	"show gtp storage-server statistics verbose"
216	Disabled	<p>"show gtp storage-server local file statistics verbose"</p> <p><b>Important</b> After you configure this command, you must save the configuration and then reload the chassis for the command to take effect. For information on saving the configuration file and reloading the chassis, refer to the <i>System Administration Guide</i> for your deployment.</p>



No.	Default SDR	Command String
217	Disabled	"show gtp storage-server local file counters all"  <b>Important</b> After you configure this command, you must save the configuration and then reload the chassis for the command to take effect. For information on saving the configuration file and reloading the chassis, refer to the <i>System Administration Guide</i> for your deployment.
218	Disabled	"show gtp storage-server streaming file statistics verbose"
219	Disabled	"show gtp storage-server streaming file counters all"
220	Disabled	"show gtp group all"
221	Enabled	"show hd-storage-policy statistics all verbose"
222	Enabled	"show hd-storage-policy counters all verbose"
223	Disabled	"show dhcp statistics verbose"
224	Disabled	"show npu table"
225	Disabled	"show npu sf hw-info"
228	Enabled	"show npu asr5500"
229	Disabled	"show l2tp statistics"
230	Enabled	"show fabric asr5500"
231	Enabled	"show vpn subsystem facility vpnmgr"
232	Enabled	"show session recovery status verbose"
233	Enabled	"show clock all"
234	Disabled	"show snmp statistics verbose"
235	Disabled	"show llc statistics verbose"
236	Disabled	"show bssgp statistics verbose"
237	Disabled	"show bssap+ statistics verbose"
238	Disabled	"show network-service-entity ip-config"
239	Disabled	"show network-service-entity fr-config"
240	Disabled	"show gprsns statistics sns-msg-stats"

No.	Default SDR	Command String
241	Disabled	"show radius authentication servers detail"
242	Disabled	"show radius accounting servers detail"
243	Enabled	"show radius counters all"
244	Enabled	"debug console card cpu tail 4000 only"
245	Enabled	"show rct stats verbose"
246	Enabled	"show heartbeat stats hatcpus"
247	Disabled	"show ntp associations all"
248	Disabled	"show npu details"
249	Disabled	"show active-charging service all"
250	Disabled	"show active-charging tcp-proxy statistics all verbose debug-info"
251	Disabled	"show active-charging edr-udr-file flow-control-counters verbose debug-only"
252	Disabled	"show active-charging service statistics"
253	Disabled	"show active-charging analyzer statistics"
254	Disabled	"show active-charging dns-learnt-ip-addresses statistics sessmgr all verbose"
255	Disabled	"show active-charging analyzer statistics name ip verbose"
256	Disabled	"show active-charging analyzer statistics name ipv6 verbose"
257	Disabled	"show active-charging analyzer statistics name tcp verbose"
258	Disabled	"show active-charging analyzer statistics name http verbose"
259	Disabled	"show active-charging charging-action statistics"
260	Disabled	"show active-charging rulebase statistics"
261	Disabled	"show active-charging ruledef statistics all charging"
262	Enabled	"show active-charging ruledef statistics all firewall wide"
263	Disabled	"show active-charging regex status all"
264	Disabled	"show active-charging regex statistics memory summary"

No.	Default SDR	Command String
265	Disabled	"show active-charging regex statistics ruledef summary"
266	Disabled	"show active-charging edr-format statistics"
267	Disabled	"show active-charging subsystem all debug-only"
268	Disabled	"debug acsmgr show flow-stats cumulative all-flows"
269	Disabled	"debug acsmgr show flow-stats cumulative http"
270	Disabled	"debug acsmgr show flow-stats cumulative ip"
271	Disabled	"debug acsmgr show flow-stats cumulative tcp"
272	Disabled	"debug acsmgr show flow-stats cumulative udp"
273	Disabled	"debug acsmgr show flow-stats max-simultaneous-flows all-flows"
274	Disabled	"debug acsmgr show flow-stats max-simultaneous-flows http"
275	Disabled	"debug acsmgr show flow-stats max-simultaneous-flows ip"
276	Disabled	"debug acsmgr show flow-stats max-simultaneous-flows tcp"
277	Disabled	"debug acsmgr show flow-stats max-simultaneous-flows udp"
278	Disabled	"debug acsmgr show flow-stats duration-based all-flows"
279	Disabled	"debug acsmgr show flow-stats duration-based tcp"
280	Disabled	"debug acsmgr show flow-stats duration-based udp"
281	Disabled	"debug acsmgr show flow-stats lifetime-based all-flows"
282	Disabled	"debug acsmgr show p2p detection-params set"
283	Disabled	"debug acsmgr show rule-optimization-information"
284	Disabled	"debug sessmgr charging-service show-stats all"

No.	Default SDR	Command String
285	Disabled	"debug acsmgr show memory usage"
286	Disabled	"debug aaamgr show memory usage"
287	Disabled	"show active-charging credit-control statistics debug-info"
288	Disabled	"show active-charging credit-control session-states"
289	Disabled	"show active-charging credit-control statistics"
290	Disabled	"show diameter endpoints all"
291	Disabled	"show diameter endpoints all debug-info"
292	Disabled	"show diameter route table debug-info"
293	Disabled	"show diameter peers full debug"
294	Disabled	"show diameter aaa-statistics"
295	Disabled	"show diameter aaa-statistics all"
296	Disabled	"show diameter aaa-statistics debug-info"
297	Disabled	"show diameter accounting servers debug-info"
298	Disabled	"show diameter authentication servers debug-info"
299	Disabled	"show diameter statistics"
300	Disabled	"show diameter statistics debug-info"
301	Disabled	"show diameter statistics proxy"
302	Disabled	"show diameter statistics proxy debug-info"
303	Disabled	"show diameter dynamic-dictionary all contents"
304	Disabled	"show active-charging edr-udr-file statistics"
305	Disabled	"show active-charging firewall statistics debug-info"
306	Disabled	"show active-charging nat statistics"
307	Disabled	"show demuxmgr statistics asngwmgr all"
308	Disabled	"show asngw-service all"
309	Disabled	"show asngw-service statistics verbose"
310	Disabled	"show demuxmgr statistics asnpcmgr all"
311	Disabled	"show asnpc-service all"

No.	Default SDR	Command String
312	Disabled	"show asnpc-service statistics verbose"
313	Disabled	"show demuxmgr statistics phsgwmgr all"
314	Disabled	"show phsgw-service all"
315	Disabled	"show phsgw-service statistics verbose"
316	Disabled	"show demuxmgr statistics phspcmgr all"
317	Disabled	"show phspc-service all"
318	Disabled	"show phspc-service statistics verbose"
319	Disabled	"show demuxmgr statistics magmgr all"
320	Disabled	"show active-charging content-filtering category policy-id all"
321	Disabled	"show content-filtering category database all verbose"
322	Disabled	"show content-filtering category database facility srdmgr all verbose"
323	Disabled	"show content-filtering category statistics"
324	Disabled	"show content-filtering category statistics facility srdmgr all"
325	Disabled	"show active-charging content-filtering category statistics"
326	Disabled	"show active-charging content-filtering server-group statistics verbose"
327	Disabled	"show active-charging url-blacklisting statistics"
328	Disabled	"show url-blacklisting database all"
329	Disabled	"show url-blacklisting database facility acsmgr all"
330	Disabled	"show active-charging tethering-detection database"
331	Disabled	"show active-charging tethering-detection database sessmgr all"
332	Disabled	"show active-charging tethering-detection statistics"
333	Disabled	"show ims-authorization service statistics"
334	Disabled	"show ims-authorization policy-control statistics"
335	Disabled	"show ims-authorization policy-control statistics debug-info"

No.	Default SDR	Command String
336	Disabled	"show local-policy statistics summary"
337	Disabled	"show rohc statistics"
338	Disabled	"show dns client statistics"
339	Disabled	"show hss-peer-service service all"
340	Disabled	"show ipms status all"
341	Disabled	"show ipms status debug-info"
342	Disabled	"show kvstore"
343	Disabled	"show kvstore verbose"
344	Disabled	"show kvstore kvclient"
345	Disabled	"show kvstore kvmgr"
346	Disabled	"show pcc-service all"
347	Disabled	"show pcc-service statistics all"
348	Disabled	"show pcc-policy service all"
349	Disabled	"show pcc-policy service statistics all"
350	Disabled	"show pcc-quota service all"
351	Disabled	"show pcc-quota service statistics all"
352	Disabled	"show pcc-af service all"
353	Disabled	"show pcc-af service statistics all"
354	Disabled	"show pcc-sp-endpoint all"
355	Disabled	"show pcc-sp-endpoint statistics all"
356	Disabled	"show event-notif server all"
357	Disabled	"show event-notif statistics"
358	Disabled	"show demux-mgr statistics bindmux all"
359	Disabled	"show congestion-control configuration"
360	Disabled	"show congestion-control statistics mme full"
361	Disabled	"show congestion-control statistics imsigr all full"
362	Enabled	"show ge-switch counters (second sample)"
363	Enabled	"ethtool -S cpeth"
365	Disabled	"show cli history"
366	Disabled	"card-cpu boxer summary"
367	Disabled	"show sls-service all"

No.	Default SDR	Command String
368	Disabled	"show sls-service peers all"
369	Disabled	"show sls-service statistics all"

Notes:

- Enabled = Included in default record section
- Disabled = Not included in default record section







## APPENDIX **F**

# Cisco Secure Boot

---

This appendix briefly describes the Cisco Secure Boot process and how it impacts image naming conventions.

It contains the following sections:

- [Fundamental Concepts, on page 509](#)
- [Secure Boot Overview, on page 509](#)
- [MIO2 Support for Secure Boot, on page 510](#)
- [Image Naming Conventions, on page 510](#)
- [Verifying Authenticity, on page 510](#)

## Fundamental Concepts

Digital signing involves creating a unique digital signature for a given block of data such as software code (often called code or image signing). The signature is created utilizing a hashing algorithm similar to a checksum. Software code can be signed this way and checked at runtime to validate it has not been changed. Typically the code gets a signature calculated by the code owner and this signature is then stored on the system with the code. When the code later executes, it can self validate by using the same algorithm to create its own signature and compare to the pre-computed stored signature, or some other system element can do this signature calculation and check.

A Trusted Element in the scope of system software is a piece of code that is known to be authentic. Trusted code is either immutable (stored in such a way to prevent modification) or sufficient validation mechanisms are in place to insure its authenticity.

The Root of Trust is the lowest layer of the system at which a guaranteed trusted element exists. If the first code executed on systems is immutable, it becomes the Root of Trust in that system.

A Chain of Trust is a series of Trusted Elements whereby each element in the chain is validated as "trusted" by the element before it. A Chain of Trust starts with a Root of Trust element, which validates successive element in the chain, and so on.

## Secure Boot Overview

Cisco Secure Boot places the Root of Trust in a hardware chip device on a circuit card where it cannot be changed. The first code (microloader) that executes immediately after power on is guaranteed to be legitimate code from Cisco and programmed during the time of system manufacturing. Furthermore, all software images can be cryptographically verified against modifications prior to load/execution.

The goal of Cisco Secure Boot technology is to address potential issues associated with unprotected boot code.

Once a piece of code is validated, it can be trusted and is allowed to assume control of the processor. Each step of the boot sequence verifies the next step of the boot module via a code-signed module (Chain of Trust).

## MIO2 Support for Secure Boot

The ASR 5500 MIO2 supports Secure Boot with a digitally signed image having a Release key. Production MIO2 cards require an image filename signed with a Release key suffix of **.SPA**. For example, `asr5500-21.0.0.bin.SPA`



---

**Important** MIO, DPC and DPC2 cards will also have digitally signed boot images, but they will ignore the signature.

---

## Image Naming Conventions

To distinguish signed from unsigned images, Release Engineering adds suffixes to build names for images that are signed. For example, `asr5500-20.0.0.bin.SPA` indicates a Release key signed as deployable in a customer network.

## Verifying Authenticity

The Exec mode **show software authenticity** command displays information about the chain of trust and authentication process for starfile images.

The syntax for this command is:

```
show software authenticity { file url [validate] | keys | running }
```

Notes:

- **file url [ validate ]** displays authenticity information for starfile images on flash or over the network. The **validate** option performs digital signature validation of the image.
- **keys** displays public StarOS key information for each of the key storage regions (Primary, Backup), as well as Rollover key information.
- **running** displays information about the chain of trust for all running software images: StarOS, CFE (bootstrap), BIOS/UEFI (Unified Extensible Firmware Interface) and the microloader.

For additional information about this command, see the *Command Line Interface Reference*.