



Policy Enforcement Points

- [Overview, page 1](#)
- [Policy Enforcement Point Tree, page 2](#)
- [Adding a Policy Enforcement Point, page 2](#)

Overview

A Policy Enforcement Point, or PEP, is a component of policy-based management that might be a network access system (NAS). PEPs are not limited to NAS devices however.

Consider, when a user tries to access a file on a network or server that uses policy-based access management, the PEP describes the user's attributes to other entities on the system. The PEP gives the Policy Decision Point (PDP) the job of deciding whether or not to authorize the user based on the description of the user's attributes. Applicable policies are stored on the system and are analyzed by the PDP. The PDP makes it's decision and returns the decision. Then, the PEP lets the user know whether or not they have been authorized to access the requested resource.

Policy Enforcement Point Tree

Upon installation of Cisco Policy Suite, the Policy Enforcement Points tree under **Reference Data** tab resembles this.

Figure 1: Policy Enforcement Point Tree



At install time, you need to determine what policy enforcement points your installation use and what features you need to install. PEPS might be:

- Generic RADIUS Device Pool
- ISG pool
- Cisco ASR 5K
- Cisco ASR9K
- MAG
- IWAG
- Cisco WLC

Consult your Cisco Technical Representative for configuring a custom site.

Adding a Policy Enforcement Point

This section covers the following topics:

- [Generic Radius Device Pool](#), on page 3

- [ISG Pools](#), on page 11
- [ASR9K PEP Configuration](#), on page 34
- [ASR5K PEP Configuration](#), on page 39
- [MAG PEP Configuration](#), on page 42
- [iWAG PEP Configuration](#), on page 45
- [Cisco WLCs](#), on page 51

Generic Radius Device Pool

This example shows you how to add a Generic RADIUS device as a policy enforcement point. Your PEP may be different, but you can easily follow this example.

Step 1 Click **Reference Data** tab > **Policy Enforcement Points** node.

Step 2 Choose the link from the main window that matches your type of PEP. For this example, select **Generic RADIUS Device Pool**. You might open up the Generic RADIUS Device Pool folder to see if it has any PEPs already created.

On creating the child by selecting the Generic RADIUS Device Pool will see the below PEP configuration page.

Figure 2: Generic Radius Device Pool

Generic RADIUS Device Pool
General Selection

<p>*Name <input type="text" value="default"/></p> <p>Default Shared Secret <input type="text"/></p> <p>*CoA Port <input type="text" value="1700"/></p> <p>*CoA Timeout Seconds <input type="text" value="3"/></p> <p>*Access Request Guard Timer (Milliseconds) <input type="text" value="0"/></p> <p>Disconnect Template <input type="text"/> <input type="button" value="select"/> <input type="button" value="clear"/></p> <p><input type="checkbox"/> Dup Check With Framed Ip</p> <p><input type="checkbox"/> Radius Network Session Correlation</p>	<p>Description <input type="text"/></p> <p>Default CoA Shared Secret <input type="text"/></p> <p>*CoA Retries <input type="text" value="3"/></p> <p>Correlation Key <input type="text" value="AccountSessionId"/></p> <p>Coa Disconnect Template <input type="text"/> <input type="button" value="select"/> <input type="button" value="clear"/></p> <p>Proxy Access Accept Filter <input type="text"/> <input type="button" value="select"/> <input type="button" value="clear"/></p> <p><input type="checkbox"/> Dup Check With Mac Address</p> <p><input checked="" type="checkbox"/> Control Session Lifecycle</p>
---	--

Devices

*IP Address or IP Range (CIDR notation)	Shared Secret	CoA Shared Secret	Loopback Addresses

215111

Defining a Policy Enforcement Point

Step 1 Provide the name for the PEP created above for Generic RADIUS Device Pool.

Step 2 Fill in the RADIUS Device Pool screen.

The fields in the top area of the screen apply to all the devices listed in the Devices table. To use other addresses or secrets, specify shared secret and CoA Shared secret for individual devices against the IP Address.

Or

If you have a RADIUS device that uses different values from the ones displayed in the top area, create another device pool to accommodate that information.

Table 1: Generic RADIUS Device Pool Parameters

Parameter	Description
General Information	The fields in this area of the screen apply to all of the RADIUS devices defined except for those in the Device table at the bottom. If you have a RADIUS device that uses different values from the ones displayed in this area, create another RADIUS device pool to accommodate that information.
Name	Name of the RADIUS device pool. This name does not have to be unique, but best practice is to make it unique.
Description	Helpful information about the device pool.
Default Shared Secret	The shared password or phrase word between Policy Builder and the Radius device.
Default CoA Shared Secret	This shared secret is used between Policy Builder and the RADIUS devices unless a different one is specified in the Devices table below.
CoA Port	The hardware port on the RADIUS device that listens for authentication tries. The default CoA port is 1813.
CoA Retries	The number of times that Policy Builder tries to authenticate with the RADIUS device in the list below.
CoA Timeout Seconds	The number of seconds that CPS tries to authenticate with an Radius device.
Correlation Key	This is the key that correlates between the subscriber authentication request and the rest of the requests. Your choices are these: <ul style="list-style-type: none"> • AccountSessionId • callingStationId • Tgpp2CorrelationId • UserId
Access Request Guard Timer	Enables the number of seconds between an Access-Accept being sent and the accounting start being received. If the Accounting start is not received before the timer expires, then the session is dropped.
CoA Disconnect Template	What you select here determines the RADIUS template used when a CoA message is sent to terminate a subscriber session on the RADIUS device.
Disconnect Template	Your selection here determines the disconnect template that is used when using the Packet of Disconnect message to terminate a subscriber session on the RADIUS device. Your RADIUS device should support either CoA or PoD.

Parameter	Description
Proxy Access Accept Filter	AVP's provided in this filter will only be allowed to send in the response to client other AVP's are ignored or skipped.
Dup Check With Framed Ip	Select this check box to look for a CPS session with the same IP address on the Access Request or Accounting Start. If there is a session up with the same framed IP, that session is removed so that the new session can be created.
Dup Check With Mac Address	Select this check box to look for a CPS session with the same MAC address on the Access Request or Accounting Start. If there is a session up with the same MAC, that session is removed so that the new session can be created.
Radius Network Session	This provides the option to correlate the multiple device sessions in to single network session for a single subscriber. Example, if this check box is selected then if there is a device session in radius as well as in Gx for the same subscriber then both will be correlated to a single session.
Control Session Lifecycle	Decides whether all the other sessions bound to the current Gx session get terminated upon Gx session termination. Default value is checked.
Devices	This list identifies the individual RADIUS devices in this RADIUS pool.
IP Address	The IP address of a RADIUS device you are using.
Shared Secret	The shared password or phraseword between Policy Builder and the RADIUS device. If no secret is specified here, the value in the Default Shared Secret field is used.
CoA Shared Secret	The shared password of phraseword between Policy Builder and the RADIUS device for purposes of authentication. If no secret is specified here, the value in the Default CoA Shared Secret field is used.
Loopback Addresses	Loopback addresses are set here. You cannot use the management address of the ISG. If loop back address is not set properly here, the system does not function.
AVP Mappings	This table area is used for generic mappings between subscriber session AVPs and an AccessAccept for the subscriber's authentication. Information you can map is the RADIUS attribute, AVP code, and the replacement value that you wish.

Editing a Policy Enforcement Point

-
- Step 1** Login to Policy Builder GUI.
 - Step 2** Go to **Reference Data** tab > **Policy Enforcement Points**.
 - Step 3** Select the device pool that holds your device.
 - Step 4** Make your changes to the **Device Pool** window.
 - Step 5** Save your work to the local directory by clicking on the diskette icon or CTRL+S.
 - Step 6** If you are ready to commit these changes to the version control software select **File > Save to Repository**.
-

Removing a Policy Enforcement Point

At times in building out your Policy Suite deployment, or perhaps due to network reconstruction, you may want to remove a device or a device pool.

To remove the entire node, highlight the node in the tree, and then click the red X at the top.

Figure 3: Removing a Policy Enforcement Point

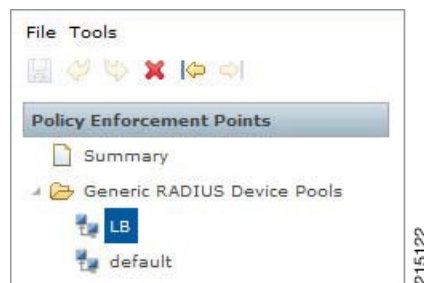

215122

To delete an individual instance from the pool, perform the following steps:

- Step 1** From the PB main screen, click **Reference Data** tab > **Policy Enforcement Points**.
- Step 2** Scroll through the tree on the left until you find the pool or device you want to delete.
- Step 3** To delete a device that is part of a pool, find the device pool and the device in the device table.
- Step 4** Select the device and click **Remove**.

Figure 4: Removing an Individual Device

*IP Address	Shared Secret	CoA Shared Secret	Loopback Addresses
192.168.181.24			10.10.10.11
192.168.181.22			10.10.10.10
0.0.0.0			

215129

Example - Generic Radius Device Pool Configuration

The following example shows the sample configuration for generic radius device policy enforcement point. Here CoA Disconnect Template is configured with required Radius service template configured with required AVP's and an IP address is added at Devices table with Shared Secret and CoA Shared Secret. If the shared

secrets are not configured in Devices table then it will use the default shared secret configured above the table for all the devices listed in Devices table.

Figure 5: Generic RADIUS Device Pool

Generic RADIUS Device Pool

***Name**

Default Shared Secret

***CoA Port**

***CoA Timeout Seconds**

***Access Request Guard Timer (Milliseconds)**

Disconnect Template
 select [clear](#)

Dup Check With Framed Ip

Radius Network Session Correlation

Description

Default CoA Shared Secret

***CoA Retries**

Correlation Key

Coa Disconnect Template
 select [clear](#)

Proxy Access Accept Filter
 select [clear](#)

Dup Check With Mac Address

Control Session Lifecycle

Devices

*IP Address or IP Range (CIDR notation)	Shared Secret	CoA Shared Secret	Loopback Addresses
1.1.1.1	cisco	cisco	

215136

A sample configuration of CoA disconnect template is as shown below. This can be customized for different AVP's as required. We need to create this template in **Reference Data** tab > **Radius Service Templates**. We can create a group first and in that group we can add a Radius Service Template as shown below.

Figure 6: Sample Configuration of CoA Disconnect Template

The screenshot displays the configuration for a RADIUS Service Template named "COA-Disconnect". The interface includes a sidebar with navigation options and a main configuration area.

RADIUS Service Template Configuration:

- Name:** COA-Disconnect
- Base Template:** (empty)

AV Pairs Table:

Vendor	*Name	Value	Tag	Type
CISCO	AVPAIR	subscriber:command~account-logoff		String
<Radius>	ACCT-SESSION-ID	\$accountSessionId		String

AV Pair Substitutions Table:

*Name	Replacement String	Associated AV Pairs
\$accountSessionId	\$accountSessionId	1 pairs selected

Buttons: Add, Remove, Actions

215147

To make a sample call using Generic Radius PEP, perform the following steps:

- Step 1** Configure the Radius plug-in in **Reference Data** tab > **System** > **Plugin Configuration** > **Radius Configuration**.
- Step 2** Configure the PEP as explained above for generic radius device pool.
- Step 3** Configure the domain as explained in Domain configuration, select the USuM Authorization type of authorization.
- Step 4** Configure the service, this service must use the AccessAcceptConfiguration Template.

Figure 7: AccessAcceptConfiguration Template

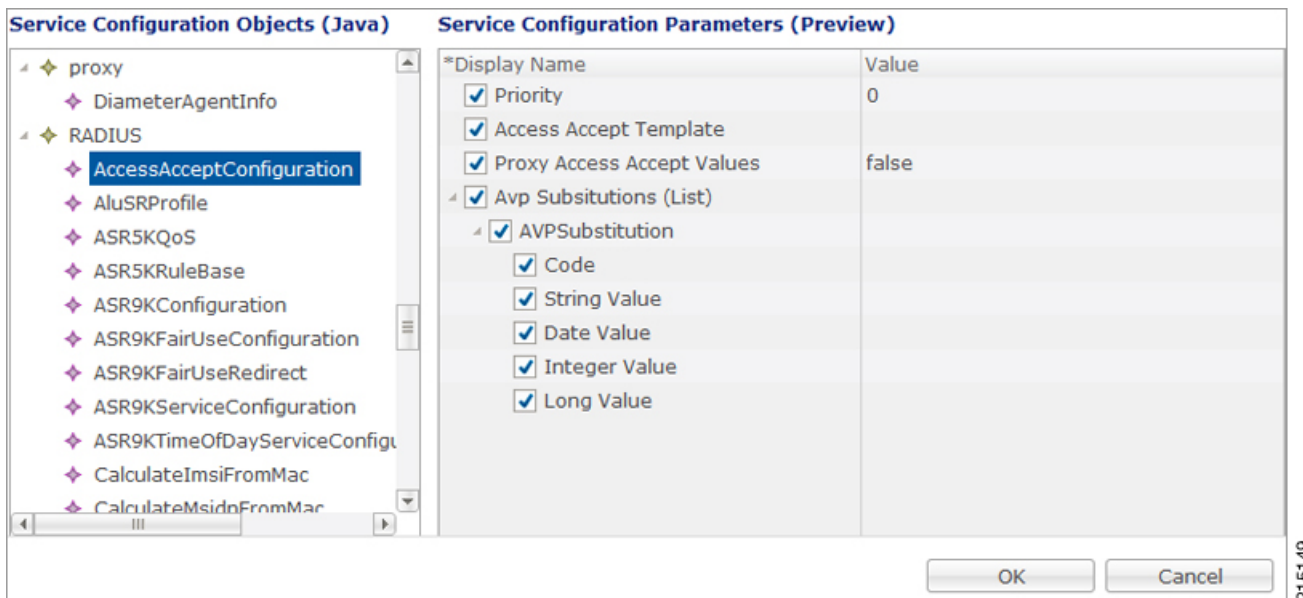

Step 5 Add a subscriber in Control Center and Assign a service to it.

Step 6 Make a radius call with NAS IP same as provided in the devices table in Generic Radius Device Pool.

Note Above steps are same for all types of PEP configuration, a few additional parameters or use case template configuration changes depending on the PEP.

ISG Pools

In the **ISG Pools Summary** window, click **ISG Pool** under **Create Child** to create a new ISG pool.

Enter the values for the required fields according to your requirement. An example is shown below.

Figure 8: ISG Pool Parameters

ISG Pool

<p>*Name <input style="width: 100%;" type="text" value="Test ISGS"/></p> <p>Default Shared Secret <input style="width: 100%;" type="text" value="aaacisco"/></p> <p>*CoA Port <input style="width: 100%;" type="text" value="1700"/></p> <p>*CoA Timeout Seconds <input style="width: 100%;" type="text" value="3"/></p> <p>*Access Request Guard Timer (Milliseconds) <input style="width: 100%;" type="text" value="0"/></p> <p>Disconnect Template <input style="width: 100%; background-color: #eee;" type="text"/> select clear</p> <p>Port Bundle Key Length <input style="width: 100%;" type="text" value="4"/></p> <p>*Accounting List <input style="width: 100%;" type="text" value="QNS_ACCT_LIST"/></p> <p><input type="checkbox"/> Dup Check With Mac Address</p> <p><input checked="" type="checkbox"/> Control Session Lifecycle</p> <p><input checked="" type="checkbox"/> Overlapping Framed Ip Addresses</p>	<p>Description <input style="width: 100%;" type="text"/></p> <p>Default CoA Shared Secret <input style="width: 100%;" type="text" value="portalcisco"/></p> <p>*CoA Retries <input style="width: 100%;" type="text" value="3"/></p> <p>Correlation Key <input style="width: 100%;" type="text" value="AccountSessionId"/></p> <p>Coa Disconnect Template <input style="width: 100%; background-color: #eee;" type="text"/> select clear</p> <p>Proxy Access Accept Filter <input style="width: 100%; background-color: #eee;" type="text"/> select clear</p> <p>*Change Service Rule <input style="width: 100%;" type="text" value="DeactivationFirst"/></p> <p><input type="checkbox"/> Dup Check With Framed Ip</p> <p><input type="checkbox"/> Radius Network Session Correlation</p> <p><input type="checkbox"/> Layer2 Session Enforcement</p> <p><input type="checkbox"/> Track Wlc Location</p>
---	--

Devices

*IP Address or IP Range (CIDR notation)	Shared Secret	CoA Shared Secret	Loopback Addresses
30.30.0.2	aaacisco	aaacisco	2.2.2.2

In the **Devices** section, enter the Subnet or IP Range (CIDR notation). To add an IP Range, click **Add**. By default, the IP Range is 0.0.0.0. Edit the IP Range according to your requirement in the CIDR notation by clicking on the default value as shown below.

Figure 9: Devices Pool

***Name**

Default Shared Secret

***CoA Port**

***CoA Timeout Seconds**

***Access Request Guard Timer (Milliseconds)**

Disconnect Template
 [select](#) [clear](#)

Port Bundle Key Length

***Accounting List**

Dup Check With Mac Address

Control Session Lifecycle

Overlapping Framed Ip Addresses

Description

Default CoA Shared Secret

***CoA Retries**

Correlation Key

Coa Disconnect Template
 [select](#) [clear](#)

Proxy Access Accept Filter
 [select](#) [clear](#)

***Change Service Rule**

Dup Check With Framed Ip

Radius Network Session Correlation

Layer2 Session Enforcement

Track Wlc Location

Devices

*IP Address or IP Range (CIDR notation)	Shared Secret	CoA Shared Secret	Loopback Addresses
30.30.0.2	aaacisco	aaacisco	2.2.2.2
30.31.0.0/24	aaacisco	aaacisco	2.2.2.2

Enter the value for Shared Secret and CoA Shared Secret by selecting the blank row of the column respectively. An example is shown.

If the IP Range in one device definition overrides with any other IP Range or any IP Address in the same or other device definitions, the Policy Builder performs a validation check and displays suitable error messages

against the Policy Enforcement Point, which has an overlapping IP range. Refer to the figure given below showing error messages due to IP Range overlap.

Figure 10: Overlapping IP Range Error

The screenshot shows the configuration page for an ISG Pool named 'Test ISGS'. The configuration includes fields for Name, Description, Shared Secrets, CoA Port, CoA Retries, CoA Timeout Seconds, Access Request Guard Timer, Disconnect Template, Proxy Access Accept Filter, Port Bundle Key Length, Accounting List, and various checkboxes for session management. A table at the bottom lists devices with their IP ranges, shared secrets, and loopback addresses. An error message is displayed at the bottom of the page, indicating a conflict with another IP range.

*IP Address or IP Range (CIDR notation)	Shared Secret	CoA Shared Secret	Loopback Addresses
30.30.30.2	aaacisco	aaacisco	2.2.2.2

The 'IP Address range conflicts with other IP range or IP provided. Change and save again.' constraint is violated on 'RADIUS Device'.

Configuration and Restrictions

- Configuration of Loopback Address in CIDR notation is not supported.
- If a Loopback Address is configured, the corresponding IP Address column should have a single IP Address and not a range of IP Address. This leads to an incorrect configuration.

Example - CPS Configuration for ISG Web-Auth Call Flow

Call Flow

Figure 11: ISG Web-Auth Call Flow

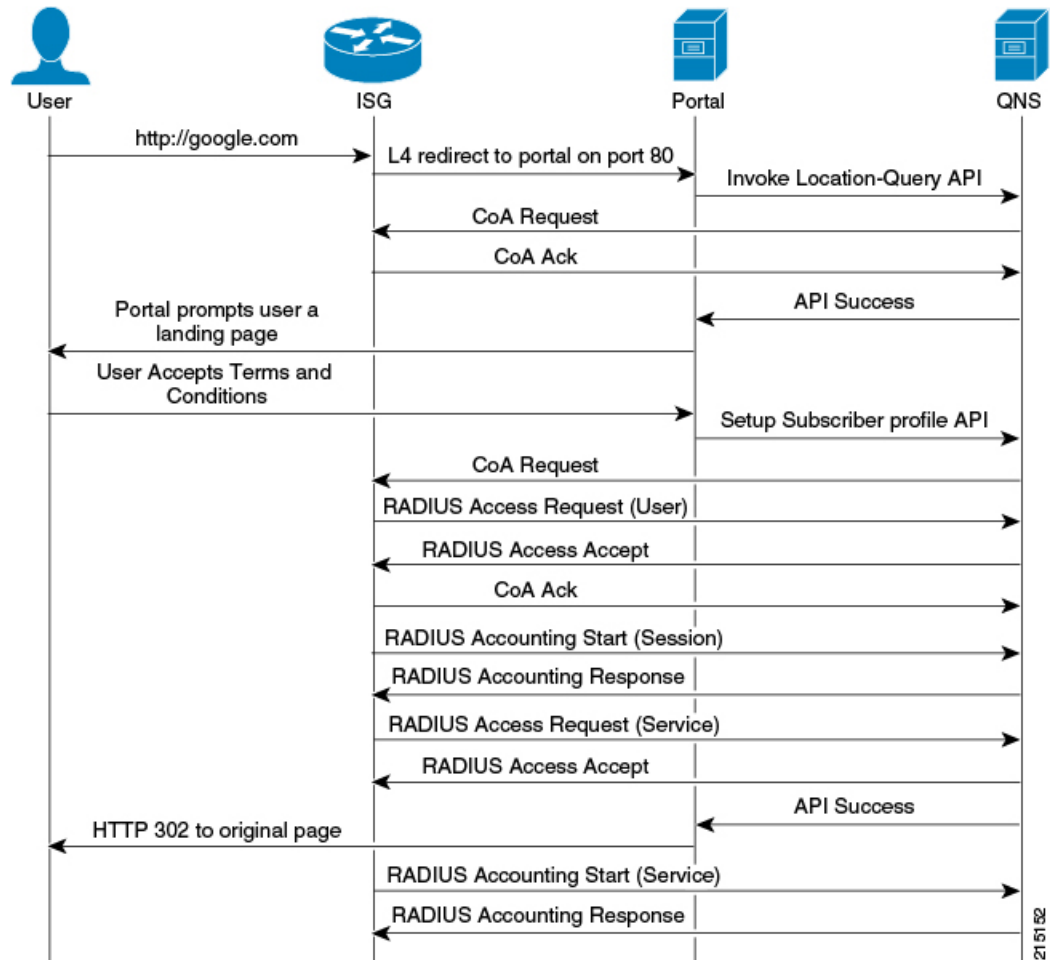

Policy Builder Configuration

ISG Pool Configuration

Configure ISGs for policy enforcement points in CPS. The configuration includes configuring ISG IPs and any loopback interfaces used in ISG configuration. The shared secret needs to match with what is configured on ISG.

Figure 12: ISG Pool Configuration

The screenshot shows the 'ISG Pool' configuration page. The configuration is for a pool named 'web-auth'. Key parameters include:

- Name:** web-auth
- Description:** web-auth
- Default Shared Secret:** cisco
- Default CoA Shared Secret:** cisco
- CoA Port:** 1700
- CoA Retries:** 3
- CoA Timeout Seconds:** 3
- Correlation Key:** AccountSessionId
- Access Request Guard Timer:** 0
- CoA Disconnect Template:** (empty)
- Proxy Access Accept Filter:** (empty)
- Port Bundle Key Length:** 0
- Change Service Rule:** DeactivationFirst
- Accounting List:** QNS_ACCT_LIST
- Devices Table:**

*IP Address or IP Range (CIDR notation)	Shared Secret	CoA Shared Secret	Loopback Addresses
30.30.0.2	cisco	cisco	2.2.2.2

Most of the parameter are already covered in Generic Radius Device Pool and some of the new parameter defined in ISG Pool Configuration are as described in the following table:

Table 2: ISG Pool Parameters

Parameters	Description
Port Bundle Key Length	The port-bundle length is used to determine the number of ports in one bundle. By default, the port-bundle length is 4 bits.

Parameters	Description
Change Service Rule	When a new service is to be activated this drop-down list tells what is the order to be followed: <ul style="list-style-type: none"> • First deactivate the already active service and then activate the new service or • First activate the new service and then deactivate the old service.
Accounting List	This list is assigned to a client when it get successfully authenticated.
Track WLC Locations	This defines enhanced location mapping feature of the client. It will track the AP or SSID location of the client and will be stored as a location in the mongo radius database.

RADIUS Templates Configuration

Radius service templates for ISG services are used to define all the services CPS will send access-accept for the requests received from ISG.

Step 1

Open Garden services will allow subscribers to allow connections to open garden services like DNS server before authentication is done. Cisco AVPAIRS are defined here which will pushed to ISG to apply open garden access lists.

Figure 13: RADIUS Templates Configuration - 1

215104

Step 2 Define PBHK services for subscriber sessions when ISG send the access-requests for the subscribers. CPS will push the port bundle configuration to be enabled for sessions.

Figure 14: RADIUS Templates Configuration - 2

RADIUS Service Template

***Name** PBHK **Base Template** [select](#) [clear](#)

AV Pairs

Vendor	*Name	Value	Tag	Type
CISCO	AVPAIR	ip:portbundle=enable		String

[Show Available AV Pair Attributes To Add](#)

AV Pair Substitutions

*Name	Replacement String	Associated AV Pairs

[Add](#) [Remove](#)

Action:

Copy:

[Current RADIUS Service Template](#)

215105

Step 3 Cisco redirect services will define the AVpair values for redirect to a portal and access-lists used for redirecting subscriber traffic.

Figure 15: RADIUS Templates Configuration - 3

The screenshot displays the configuration page for a RADIUS Service Template. On the left is a navigation tree with categories like Systems, Account Balance Templates, Custom Reference Data Tables, Fault List, Notifications, Policy Enforcement Points, RADIUS Service Templates, Subscriber Data Sources, and Tariff Times. The 'RADIUS Service Templates' section is expanded, showing a list of templates including 'CISCO_REDIRECT_SERVICE', 'OPENGARDEN_SERVICE', 'PBHK', 'BASE_INTERNET_SERVICE', 'SP-ACCESS-ACCEPT', and '512K-DOWN'. The 'CISCO_REDIRECT_SERVICE' template is selected.

The main configuration area for the 'RADIUS Service Template' includes:

- *Name:** CISCO_REDIRECT_SERVICE
- Base Template:** (empty field with 'select' and 'clear' buttons)
- AV Pairs:** A table listing AV pairs for the vendor 'CISCO'.

Vendor	*Name	Value	Tag	Type
CISCO	AVPAIR	ip:l4redirect=redirect to group CISCO_PORTAL		String
CISCO	AVPAIR	ip:traffic-class=in access-group name L4REDIRECT_ACL_IN		String
- AV Pair Substitutions:** A table with columns for *Name, Replacement String, and Associated AV Pairs. It is currently empty.
- Buttons:** 'Add' and 'Remove' buttons are located below the AV Pair Substitutions table.
- Action:** A dropdown menu is present.
- Copy:** A checkbox labeled 'Current RADIUS Service Template' is checked.

215106

Step 4 Base Internet services are defined here for subscribers when they get authenticated.

Figure 16: RADIUS Templates Configuration - 4

RADIUS Service Template

***Name** **Base Template**
 BASE_INTERNET_SERVICE [clear](#)

AV Pairs

Vendor	*Name	Value	Tag	Type
CISCO	AVPAIR	ip:traffic-class=in access-group name INTERNET_ACL_IN priority 20		String
CISCO	AVPAIR	ip:traffic-class=out access-group name INTERNET_ACL_OUT priority 20		String
CISCO	AVPAIR	ip:traffic-class=out default drop		String
CISCO	AVPAIR	ip:traffic-class=in default drop		String
CISCO	AVPAIR	subscriber:accounting-list=QNS_ACCT_LIST		String

[Show Available AV Pair Attributes To Add](#)

AV Pair Substitutions

*Name	Replacement String	Associated AV Pairs

Action:

Copy:
 [Current RADIUS Service Template](#)

215107

Figure 17: RADIUS Templates Configuration - 5

Systems

Account Balance Templates

Custom Reference Data Tables

Fault List

Notifications

Policy Enforcement Points

RADIUS Service Templates

- Summary
- ASR9K Base Templates (Read)
- ASR5K Base Templates (Read)
- ISG Session (Read Only)
- ISG Access Accept and CoA Tem
- ISG Prepaid (Read Only)
- ISG Services
 - 2M-UP-DOWN
 - CISCO_REDIRECT_SERVICE
 - OPENGARDEN_SERVICE
 - PBHK
 - BASE_INTERNET_SERVICE
 - SP-ACCESS-ACCEPT**
 - 512K-DOWN
- Service Provider Specific Templat

Subscriber Data Sources

Tariff Times

RADIUS Service Template

***Name** **Base Template**

select
[clear](#)

AV Pairs

Vendor	*Name	Value	Tag	Type
<Radius>	IDLE-TIMEOUT	600		Integer
<Radius>	SESSION-TIMEOUT	3600		Integer

[Show Available AV Pair Attributes To Add](#)

AV Pair Substitutions

*Name	Replacement String	Associated AV Pairs

Action:

Copy:

[Current RADIUS Service Template](#)

215108

Figure 18: RADIUS Templates Configuration - 6

Systems

Account Balance Templates

Custom Reference Data Tables

Fault List

Notifications

Policy Enforcement Points

RADIUS Service Templates

- Summary
- ASR9K Base Templates (Read)
- ASR5K Base Templates (Read)
- ISG Session (Read Only)
- ISG Access Accept and CoA Tem
- ISG Prepaid (Read Only)
- ISG Services
 - 2M-UP-DOWN
 - CISCO_REDIRECT_SERVICE
 - OPENGARDEN_SERVICE
 - PBHK
 - BASE_INTERNET_SERVICE
 - SP-ACCESS-ACCEPT
 - 512K-DOWN**
- Service Provider Specific Templat

Subscriber Data Sources

Tariff Times

RADIUS Service Template

***Name** **Base Template** [clear](#)

AV Pairs				
Vendor	*Name	Value	Tag	Type
CISCO	SERVICE-INFO	QU;100000;D;512000		String

▶ [Show Available AV Pair Attributes To Add](#)

AV Pair Substitutions		
*Name	Replacement String	Associated AV Pairs

▼ **Action:**

Copy:

[Current RADIUS Service Template](#)

215109

Domain Configuration

Step 1

Configure a Domain “web-auth” for the subscribers and authorizations based on session Username and User Password. Set this domain as Default Domain.

Figure 19: Domain Configuration - General

The screenshot shows the 'Domain Configuration - General' page. At the top, there is a 'Name' field containing 'web-auth' and a checked 'Is Default' checkbox. Below this are tabs for 'General', 'Provisioning', 'Additional Profile Data', 'Locations', and 'Advanced Rules'. The 'General' tab is active, showing the 'Authorization' section set to 'USuM Authorization'. Under 'Authorization', there are three fields: 'User Id Field' (set to 'Session User Name'), 'Password Field' (set to 'User Password'), and 'Remote Db Lookup Key Field' (empty). To the right, the '*Domain Naming' section has a 'Domain Prefix' field (empty) and an unchecked 'Append Location' checkbox. At the bottom left, there is an 'Actions' section with a 'Create Child:' link pointing to 'Service Provider'. The number '215110' is visible in the bottom right corner of the interface.

Step 2 Define locations based on Framed IP location type.

Figure 20: Domain Configuration - Locations

🏠 **Domain**

Name

 Is Default

General
Provisioning
Additional Profile Data
Locations
Advanced Rules

***Location Matching Type**

select
clear

Location Matching Type

Name	Mapping Values	Timezone

Add
Remove
↑
↓

▼ **Actions**

Create Child:

[Service Provider](#)

215112

Step 3 Set Advanced Rules For the MAC TAL.**Figure 21: Domain Configuration - Advanced Rules**

The screenshot shows the 'Domain Configuration - Advanced Rules' page. At the top, there is a 'Name' field containing 'web-auth' and a checked 'Is Default' checkbox. Below this are tabs for 'General', 'Provisioning', 'Additional Profile Data', 'Locations', and 'Advanced Rules'. The 'Advanced Rules' tab is active. The page contains several configuration sections: 'Transparent Auto-Login (TAL) Type' with a dropdown set to 'RADIUS MAC Address', 'clear' button, and a checked 'Tal With No Domain' checkbox; 'EAP Correlation Attribute' with a dropdown, 'clear' button, and a checked 'Eap To Mac Format' checkbox; 'Unknown Service' with a dropdown, 'clear' button, and a checked 'Autodelete Expired Users' checkbox; 'Default Service' with a dropdown, 'clear' button; and 'Anonymous Subscriber Service' with a dropdown, 'select' button, and 'clear' button. There is also an 'Authentication Dampening' checkbox which is unchecked. At the bottom, there is an 'Actions' section with a dropdown arrow, 'Create Child:' with a link to 'Service Provider', and 'Copy:' with a link to 'Current Domain'. A vertical ID '215113' is located on the right side of the form.

Domain

Name: web-auth Is Default

General | Provisioning | Additional Profile Data | Locations | **Advanced Rules**

Transparent Auto-Login (TAL) Type
RADIUS MAC Address select clear Tal With No Domain

EAP Correlation Attribute
select clear Eap To Mac Format

Unknown Service
select clear Autodelete Expired Users

Default Service select clear **Anonymous Subscriber Service** select clear

Authentication Dampening

▼ Actions

Create Child:
[Service Provider](#)

Copy:
[Current Domain](#)

215113

Service Configuration: Use Case Template

Read only Use Case Templates with their service configurations used in the Service configuration.

Step 1 Auto Register MAC Credential.

Figure 22: Auto Register MAC Credential

Use Case Template (Read Only)

Name: Auto Register MAC Credential

Use Case Template | Use Case Initiators | Documentation

Service Configurations

Name
+ Registration Limit

Add Remove Up Down

Actions

Create Child:

Use Case Option

Copy:

Current Use Case Template

Registration Limit Parameters

*Display Name	Value	Bind Field	Allow Override
Register	true		<input type="checkbox"/>
Duration	0		<input checked="" type="checkbox"/>
Duration Type	Days		<input checked="" type="checkbox"/>

Add Remove Add Child Up Down

215114

Step 2 Base ISG Service.

Figure 23: Base ISG Service

Use Case Template (Read Only)

Name: ISG Base Service

Use Case Template | Use Case Initiators | Documentation

Service Configurations

Name
+ Base ISG Service
+ AccessAcceptConfiguration

+Add -Remove ↑ ↓

Actions

Create Child:

[Use Case Option](#)

Copy:

[Current Use Case Template](#)

Base ISG Service Parameters

*Display Name	Value	Bind Field	Allow Override
Priority	0		<input type="checkbox"/>
Group Name			<input type="checkbox"/>
Isg Service			<input checked="" type="checkbox"/>
Min Time Between Reactiv	30		<input type="checkbox"/>

+Add -Remove +Add Child ↑ ↓

215115

Service Configuration: Service Options

Service options based on above Use Case Templates.

Step 1 3 min service-option configuration of “Auto Register MAC Credential” Use Case Template.

Figure 24: 3 min Service Option

The screenshot displays the configuration interface for a Service Option. On the left is a tree view of the configuration hierarchy, including 'Service Options' and 'Auto Register MAC Credential'. The main area shows the configuration for a '3 min' service option. The 'Name' field is set to '3 min' and the 'Use Case Template' is 'Auto Register MAC Credential'. Below this, there are sections for 'Service Configurations' (containing a 'Registration Limit' entry) and 'Registration Limit Parameters' (a table with columns for Display Name, Value, and Pull value from...). The 'Registration Limit Parameters' table contains the following data:

*Display Name	Value	Pull value from...
Duration	3	
Duration Type	Minutes	
Register	true	

At the bottom of the interface, there are buttons for 'Add', 'Remove', 'Add Child', and navigation arrows.

21 51 16

Step 2 Base Service-option Configuration of “Base ISG Service” Use Case Template.

Figure 25: Base Service Option - Base ISG Service

The screenshot shows the 'Service Option' configuration page. On the left is a tree view of 'Use Case Templates' with 'ISG Base Service' selected. The main area has a 'Name' field containing 'Base' and a 'Use Case Template' dropdown set to 'ISG Base Service'. Below this are two sections: 'Service Configurations' and 'Base ISG Service Parameters'. The 'Service Configurations' list includes 'Base ISG Service' and 'AccessAcceptConfiguration'. The 'Base ISG Service Parameters' table is as follows:

*Display Name	Value	Pull value from...
Isg Service	512K-DOWN	

At the bottom, there are 'Add', 'Remove', and 'Add Child' buttons, along with up and down arrows. A 'Copy' section with a 'Current Service Option' button is also visible.

215117

Figure 26: Base Service Option - Access Accept Configuration

This screenshot shows the 'Service Option' configuration page with 'AccessAcceptConfiguration' selected in the 'Service Configurations' list. The 'Name' field still contains 'Base'. The 'Use Case Template' remains 'ISG Base Service'. The 'AccessAcceptConfiguration Parameters' table is as follows:

*Display Name	Value	Pull value from...
Access Accept Template	ISG_ACCESS_ACCEPT	

The interface includes the same navigation and control elements as Figure 25.

215118

Service Configuration: Service

Create a Service that will be assigned to the user account in the uSuM.

Figure 27: Service

The screenshot displays the Service Configuration interface. On the left, a tree view under 'Domains' shows 'Services' expanded, with 'Service_Z (SERVICE_Z)' selected. The main area shows the configuration for 'Service_Z'. The '*Code' field contains 'SERVICE_Z' and the '*Name' field contains 'Service_Z'. There are checkboxes for 'Enabled' and 'Suppress In Portal', both of which are checked. Below these are checkboxes for 'Balance Service' (checked) and 'Add To Sub Accounts' (unchecked). A 'Service Options' table is visible, with columns for 'Name' and '*Use Case Template'. The table contains two rows: 'Base' with 'ISG Base Service' and '3 min' with 'Auto Register MAC Credential'. Below the table are 'Add', 'Remove', and 'View Service Option Parameters' buttons. An 'Actions' section is expanded, showing 'Create Child:' with a link to 'Automatic Balance Provisioning' and 'Copy:' with a link to 'Current Service'.

Name	*Use Case Template
Base	ISG Base Service
3 min	Auto Register MAC Credential

215119

Control Center Configuration

Step 1 Create subscribers in USuM database and add service type applicable to the subscriber.

Figure 28: Create Subscriber

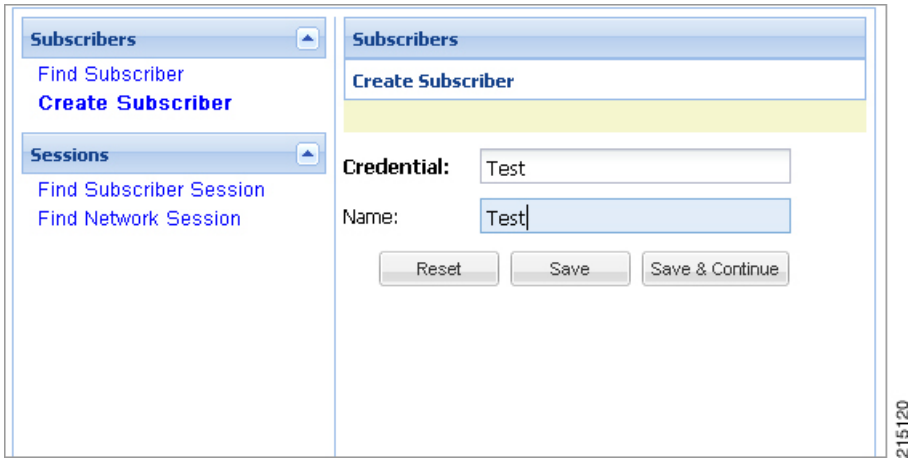

Step 2 Select **Save & Continue**. Click **Services > add**.

Figure 29: Add Service

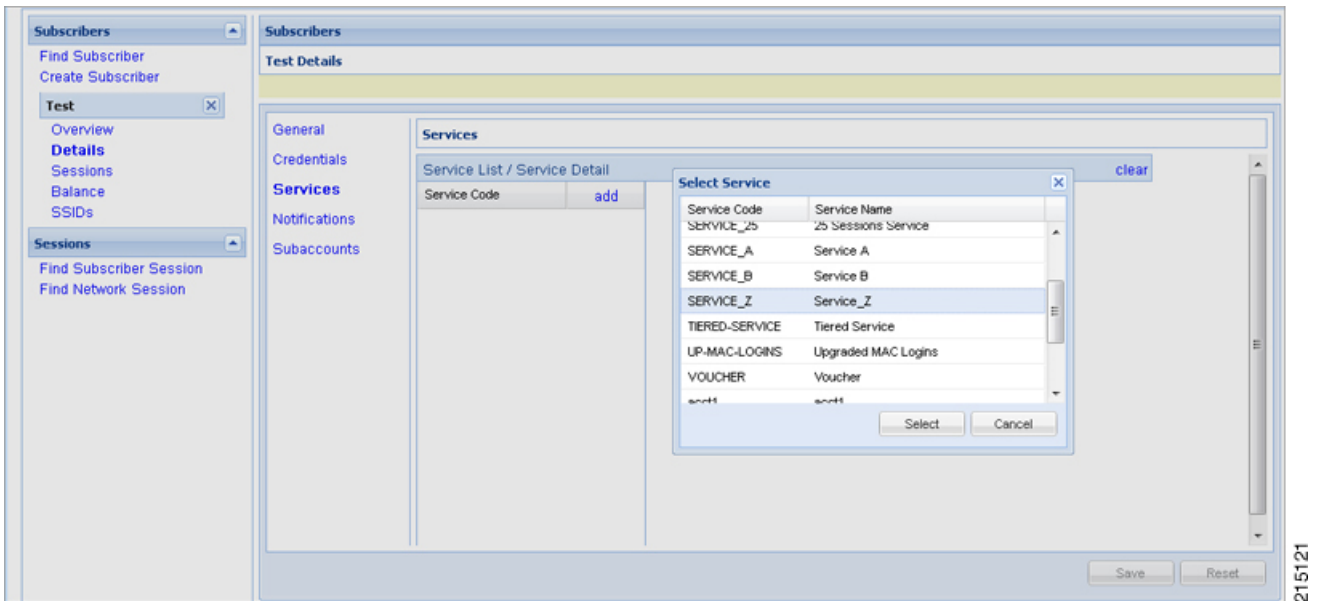

Step 3 Select a service and click **Select** to select a service from the available list of services.

Figure 30: Assign a Service

The screenshot shows a web interface for configuring subscribers. On the left is a navigation menu with sections for 'Subscribers', 'Test', and 'Sessions'. The main area is titled 'Subscribers' and contains a 'Test Details' section (highlighted in yellow) and a 'Services' section. The 'Services' section has a table with the following content:

Service List / Service Detail		clear
Service Code		add
SERVICE_Z		

At the bottom right of the main area are 'Save' and 'Reset' buttons. A vertical scroll bar is on the right side of the 'Services' table.

21 51 23

Step 4 For setting the Credentials of the subscriber, click **Credentials** > **edit**.

Figure 31: Edit the Credentials

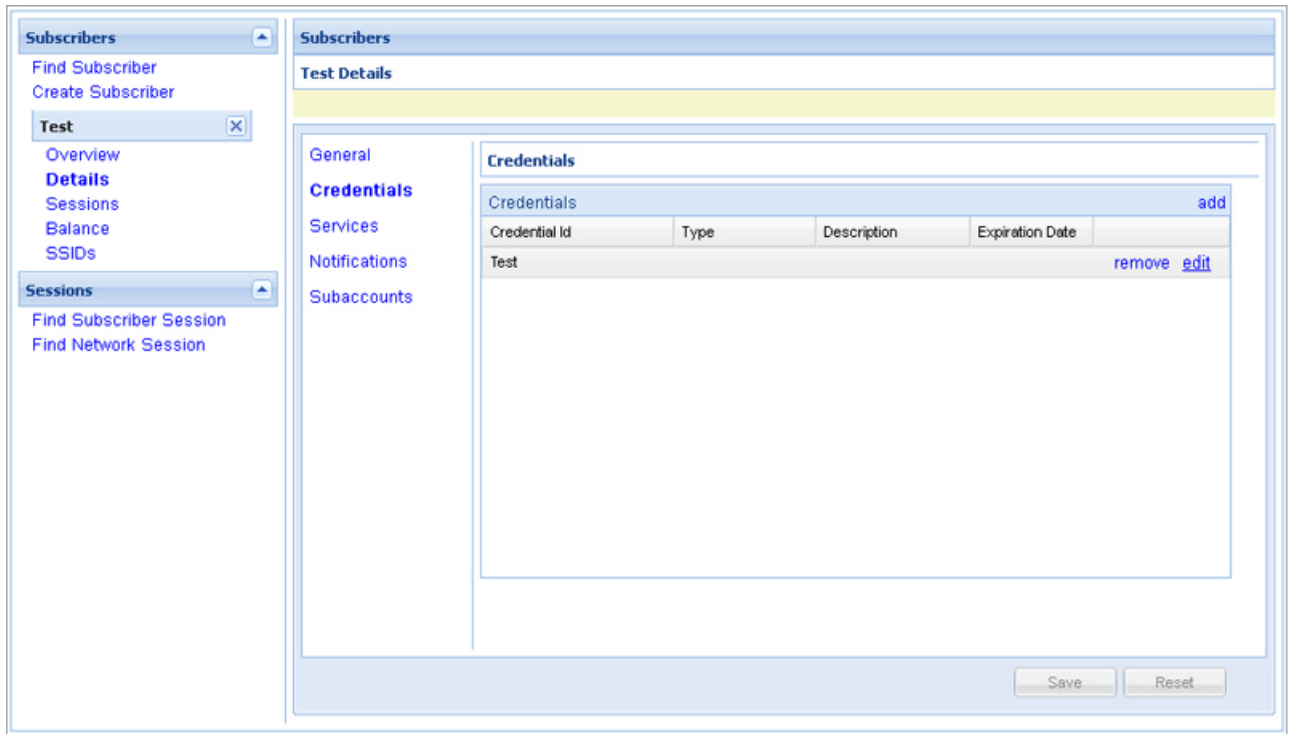

Step 5 Enter **New Password** and **Confirm Password** in the pop-up dialog box, then click **OK**.

Figure 32: Password

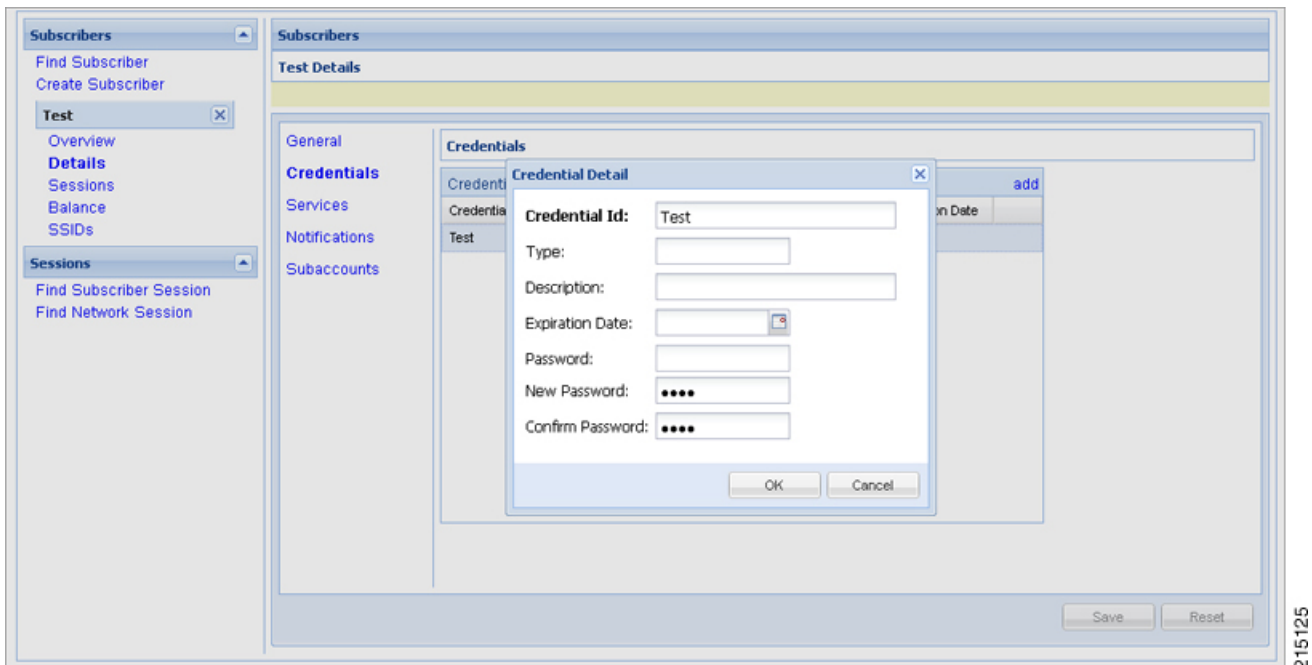

Step 6 Click **Save** to save the configuration.

ASR9K PEP Configuration

ASR9K PEP is used specifically for interfacing CPS with ASR9K devices. PEP configuration for ASR9K is same as Generic Radius device but there is one more additional parameter "Cache Account Session Id from

Access Request”. This option will store the value coming in Account-Session-Id AVP in Session database within a session.

Figure 33: ASR9K PEP Configuration

Cisco ASR9K

<p>*Name <input type="text" value="default"/></p> <p>Default Shared Secret <input type="text" value="cisco"/></p> <p>*CoA Port <input type="text" value="1700"/></p> <p>*CoA Timeout Seconds <input type="text" value="3"/></p> <p>*Access Request Guard Timer (Milliseconds) <input type="text" value="0"/></p> <p>Disconnect Template <input type="text" value=""/> <input type="button" value="select"/> clear</p> <p><input type="checkbox"/> Dup Check With Framed Ip</p> <p><input type="checkbox"/> Radius Network Session Correlation</p> <p><input type="checkbox"/> Cache Account Session Id From Access Request</p>	<p>Description <input type="text"/></p> <p>Default CoA Shared Secret <input type="text" value="cisco"/></p> <p>*CoA Retries <input type="text" value="3"/></p> <p>Correlation Key <input type="text" value="AccountSessionId"/> ▼</p> <p>Coa Disconnect Template <input type="text" value="ASR9K_DISCONNECT"/> <input type="button" value="select"/> clear</p> <p>Proxy Access Accept Filter <input type="text" value=""/> <input type="button" value="select"/> clear</p> <p><input type="checkbox"/> Dup Check With Mac Address</p> <p><input checked="" type="checkbox"/> Control Session Lifecycle</p>
--	--

Devices

*IP Address or IP Range (CIDR notation)	Shared Secret	CoA Shared Secret	Loopback Addresses
1.1.1.1	cisco	cisco	

215126

To make a sample call using ASR9K PEP, perform the following steps:

- Step 1** Configure the radius plug-in in **Reference Data** tab > **System** > **Plugin Configuration** > **Radius Configuration**.
- Step 2** Configure the PEP as explained above for ASR9K.
- Step 3** Configure the domain as explained in Domains. For example, select USuM Authorization type of authorization.
- Step 4** Configure the service, this service must use the ASR9K Templates listed below.

Figure 34: ASR9K Templates

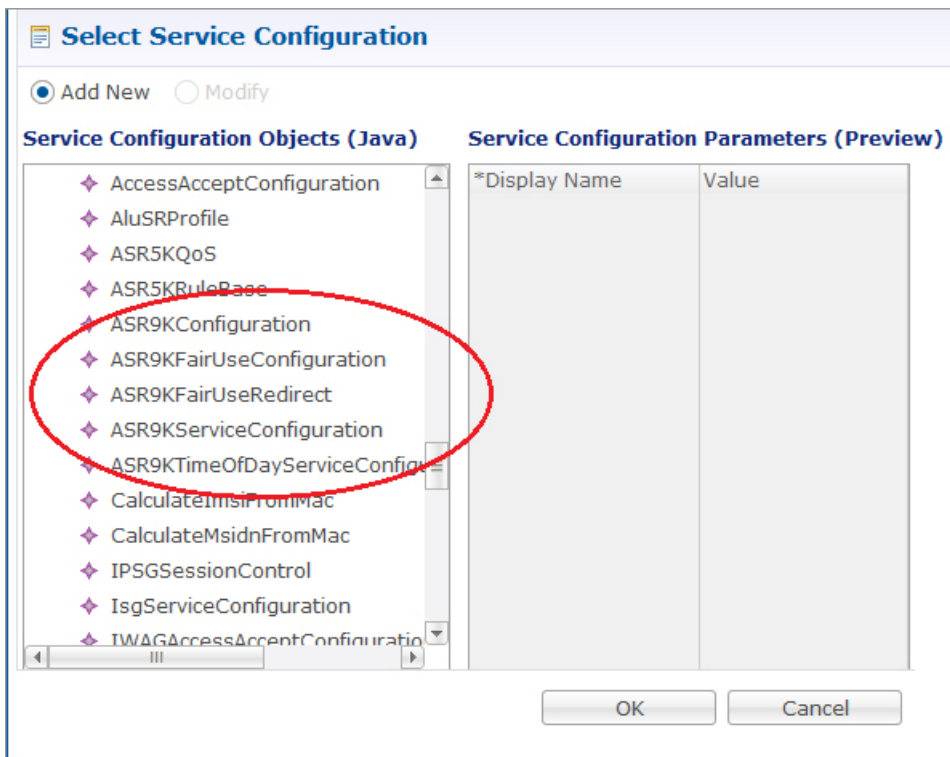

- Step 5** Add a subscriber in Control Center and assign a service to it.
- Step 6** Make a radius call with NAS IP same as provided in the devices table in ASR9K device table.

ASR9K Call Flows

Portal Based Authentication

Figure 35: Portal Based Authentication - 1

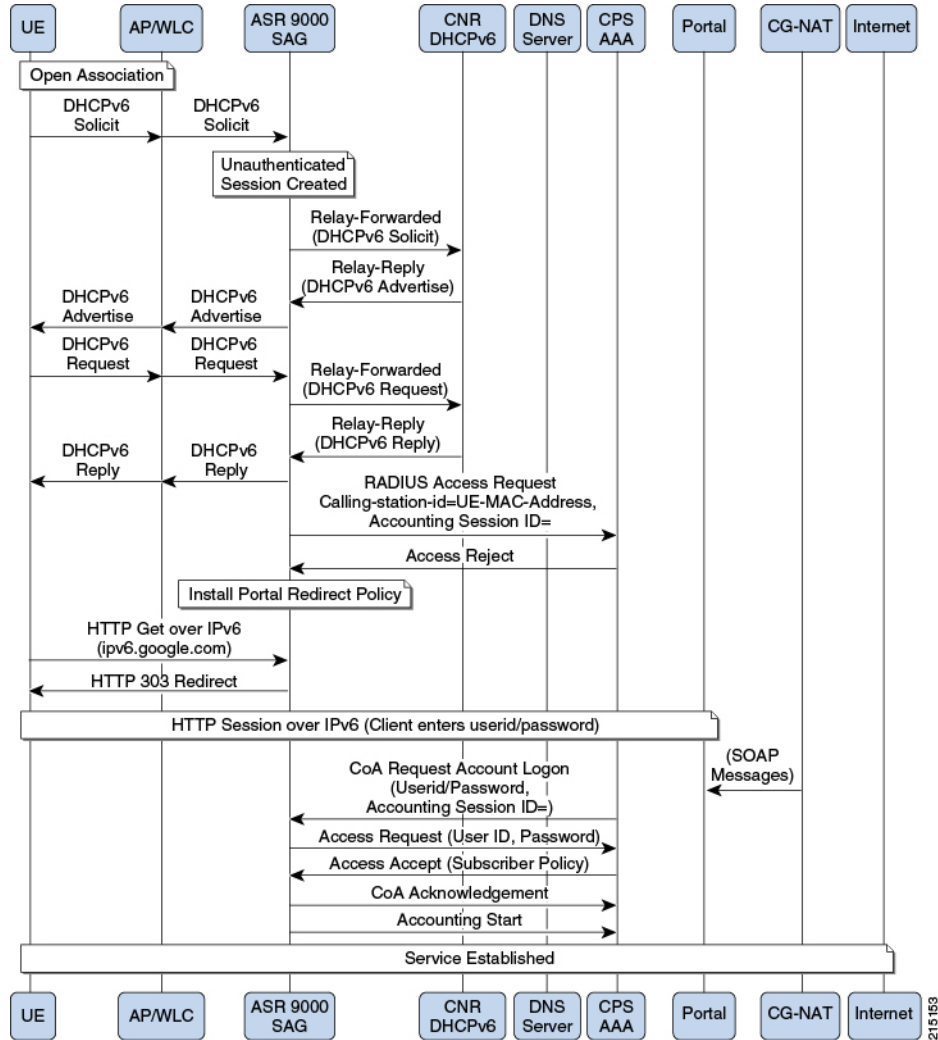
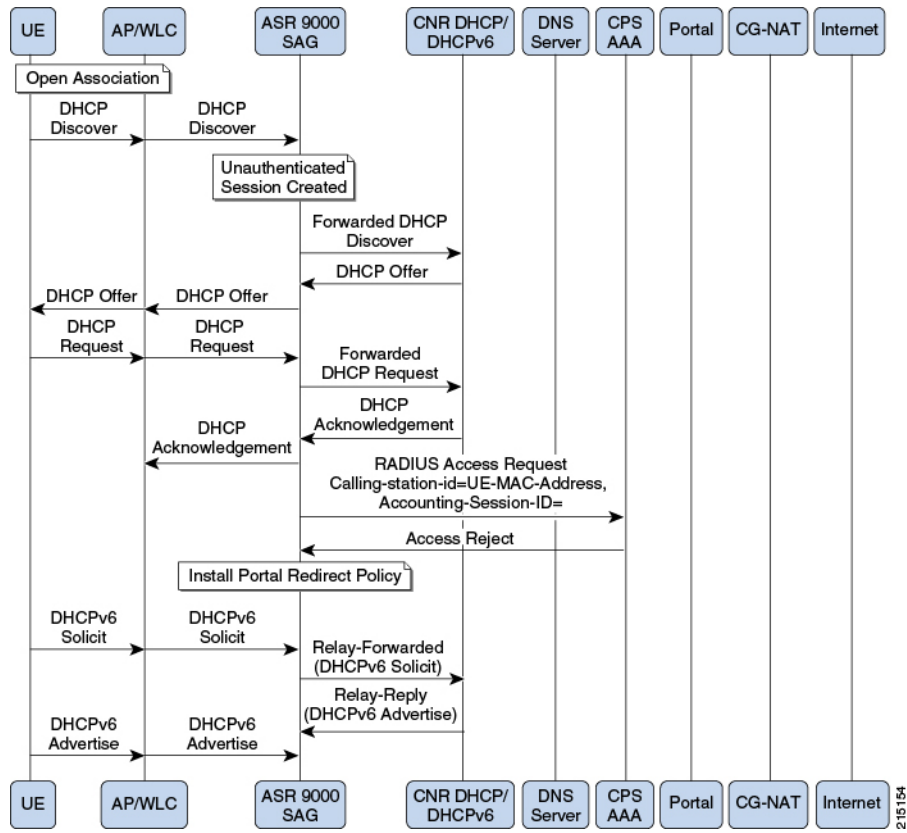
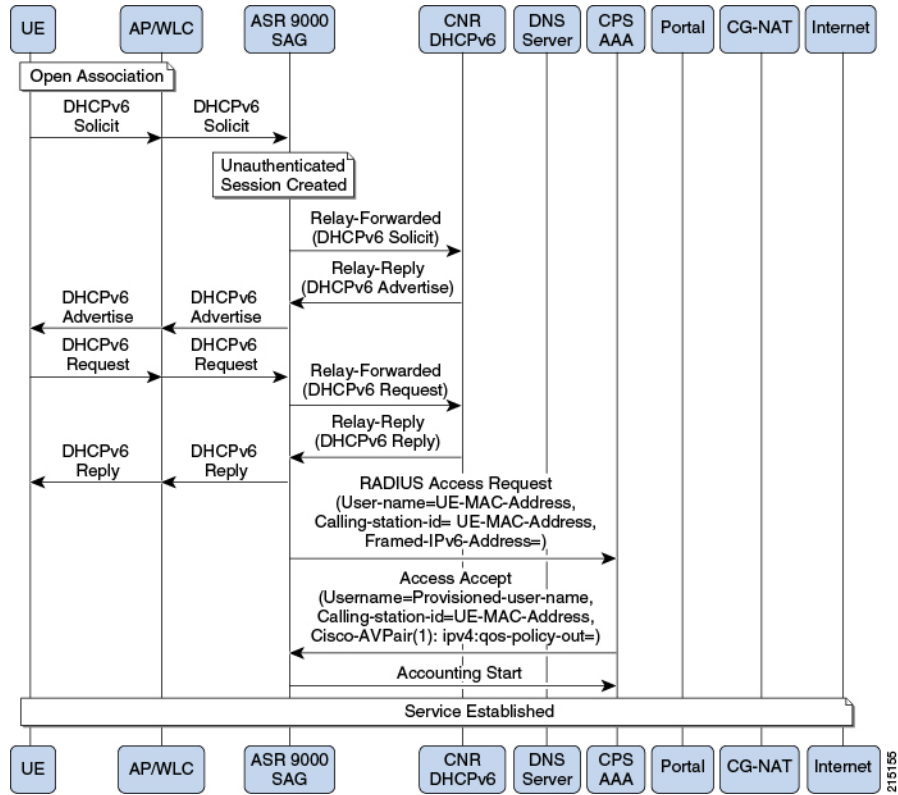

Figure 36: Portal Based Authentication - 2



MAC-TAL

Figure 37: MAC-TAL



ASR5K PEP Configuration

ASR5K PEP is used specifically for interfacing CPS with ASR5K devices. PEP configuration for ASR5K is same as Generic Radius device. This does not have any additional parameters configuration. The need of

having separate configuration is to differentiate the device type so that policy derivation/processing for ASR5K devices will be different. Service configuration for ASR5K needs to use the use case template of ASR5K.

Figure 38: ASR5K PEP Configuration

Cisco ASR5K

<p>*Name <input type="text" value="default"/></p> <p>Default Shared Secret <input type="text" value="cisco"/></p> <p>*CoA Port <input type="text" value="1700"/></p> <p>*CoA Timeout Seconds <input type="text" value="3"/></p> <p>*Access Request Guard Timer (Milliseconds) <input type="text" value="0"/></p> <p>Disconnect Template <input type="text" value=""/> <input type="button" value="select"/> clear</p> <p><input type="checkbox"/> Dup Check With Framed Ip</p> <p><input type="checkbox"/> Radius Network Session Correlation</p> <p><input type="checkbox"/> Disconnect On Web Login</p>	<p>Description <input type="text"/></p> <p>Default CoA Shared Secret <input type="text" value="cisco"/></p> <p>*CoA Retries <input type="text" value="3"/></p> <p>Correlation Key <input type="text" value="AccountSessionId"/></p> <p>Coa Disconnect Template <input type="text" value=""/> <input type="button" value="select"/> clear</p> <p>Proxy Access Accept Filter <input type="text" value=""/> <input type="button" value="select"/> clear</p> <p><input type="checkbox"/> Dup Check With Mac Address</p> <p><input checked="" type="checkbox"/> Control Session Lifecycle</p> <p><input type="checkbox"/> Send Disconnect To Source</p>
---	--

Devices

*IP Address or IP Range (CIDR notation)	Shared Secret	CoA Shared Secret	Loopback Addresses

2115128

To make a sample call using ASR5K PEP, perform the following steps:

- Step 1** Configure the radius plug-in in **Reference Data** tab > **System** > **Plugin Configuration** > **Radius Configuration**.
- Step 2** Configure the PEP as explained above for ASR5K.
- Step 3** Configure the domain as explained in Domains chapter in this book. For example, select USuM Authorization type of authorization.
- Step 4** Configure the service, this service must use the ASR5K Templates listed below.

Figure 39: ASR5K Templates

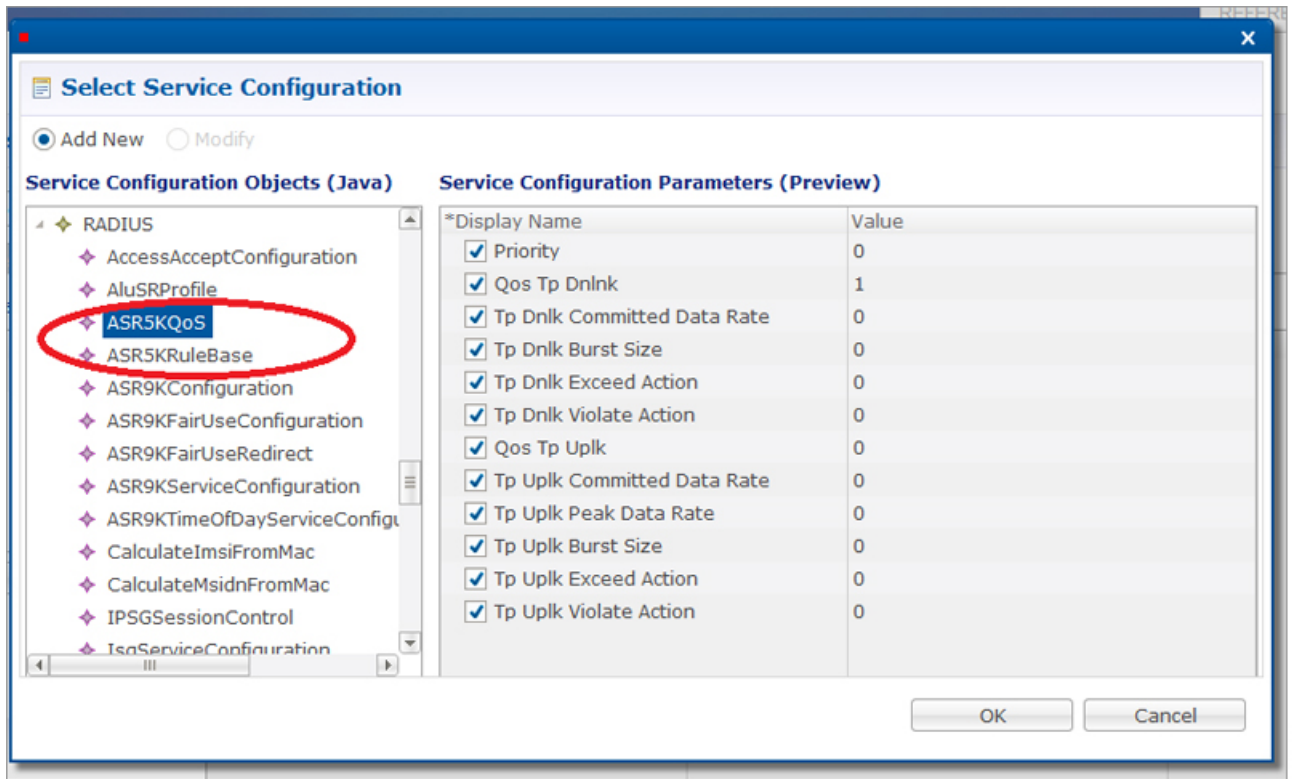

- Step 5** Add a subscriber in Control Center and assign a service to it.
- Step 6** Make a radius call with NAS IP same as provided in the devices table in ASR5K device table.

MAG PEP Configuration

MAG PEP is used specifically for interfacing CPS with MAG (Mobility Access Gateway). PEP configuration for MAG is same as Generic Radius Device Pool.

Figure 40: MAG PEP Configuration

MAG

<p>*Name</p> <input type="text" value="default"/>	<p>Description</p> <input type="text"/>								
<p>Default Shared Secret</p> <input type="text"/>	<p>Default CoA Shared Secret</p> <input type="text"/>								
<p>*CoA Port</p> <input type="text" value="1700"/>	<p>*CoA Retries</p> <input type="text" value="3"/>								
<p>*CoA Timeout Seconds</p> <input type="text" value="3"/>	<p>Correlation Key</p> <input type="text" value="AccountSessionId"/>								
<p>*Access Request Guard Timer (Milliseconds)</p> <input type="text" value="0"/>	<p>Coa Disconnect Template</p> <input type="text"/> <input type="button" value="select"/> clear								
<p>Disconnect Template</p> <input type="text"/> <input type="button" value="select"/> clear	<p>Proxy Access Accept Filter</p> <input type="text"/> <input type="button" value="select"/> clear								
<p>Access Accept Template</p> <input type="text"/> <input type="button" value="select"/> clear	<p>Lma Address</p> <input type="text"/>								
<p>Mcc</p> <input type="text"/>	<p>Mnc</p> <input type="text"/>								
<p>*Default Realm</p> <input type="text" value="wlan.mnc316.mcc95.3gppnetwc"/>	<p><input type="checkbox"/> Dup Check With Framed Ip</p>								
<p><input type="checkbox"/> Dup Check With Mac Address</p>	<p><input type="checkbox"/> Radius Network Session Correlation</p>								
<p><input checked="" type="checkbox"/> Control Session Lifecycle</p>	<p><input type="checkbox"/> Partial Mac For Mcc Mnc</p>								
<p>Devices</p> <table border="1" style="width: 100%; border-collapse: collapse;"> <thead> <tr> <th style="width: 45%;">*IP Address or IP Range (CIDR notation)</th> <th style="width: 15%;">Shared Secret</th> <th style="width: 15%;">CoA Shared Secret</th> <th style="width: 25%;">Loopback Addresses</th> </tr> </thead> <tbody> <tr> <td> </td> <td> </td> <td> </td> <td> </td> </tr> </tbody> </table>		*IP Address or IP Range (CIDR notation)	Shared Secret	CoA Shared Secret	Loopback Addresses				
*IP Address or IP Range (CIDR notation)	Shared Secret	CoA Shared Secret	Loopback Addresses						

215150

The following are the additional parameters used for MAG:

Table 3: MAG PEP Configuration Parameters

Parameter	Description
LMA Address	LMA address will be sent to MAG in Access Accept response.
MCC	MCC and MNC is used to derive the partial MAC Address.
MNC	MCC and MNC is used to derive the partial MAC Address.
Default Realm	This default realm will be added to the UserId i.e. IMSI, User Id format will be encodedImsi@defaultRealm. Default Realm should be "wlan.mncxxx.mccxx.3gppnetwork.org", otherwise "wlan.3gppnetwork.org".
Partial Mac for Mcc Mnc	If this is checked, a partial MAC IMSI will be derived based on the MCC, MNC and MAC.

To make a sample call using MAG PEP, perform the following the below steps:

- Step 1** Configure the Radius plug-in in **Reference Data** tab > **System** > **Plugin Configuration** > **Radius Configuration**.
- Step 2** Configure the PEP as explained above for MAG.
- Step 3** Configure the domain as explained in Domains chapter in this book. For example, select the USuM Authorization type of authorization.
- Step 4** Configure the service, this service must use the MAG Template listed below.

Figure 41: MAG Template

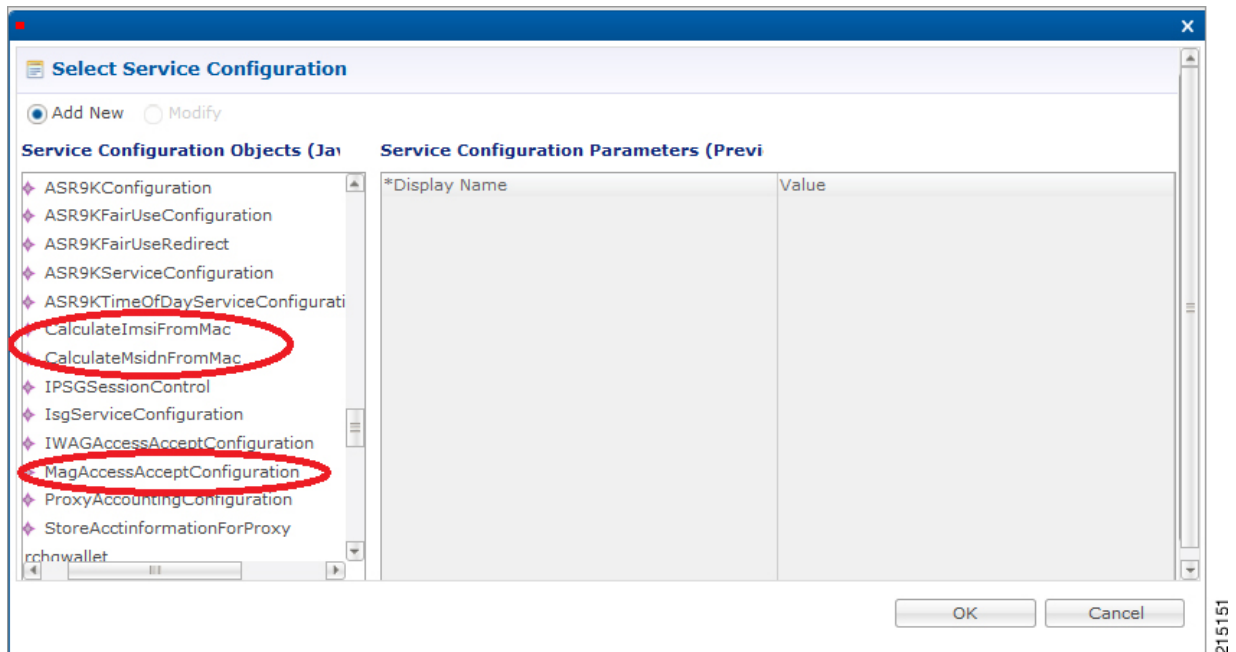

iWAG PEP Configuration

iWAG PEP is used specifically for interfacing CPS with iWAG devices. PEP configuration for iWAG is same as Generic Radius device. This does not have any additional parameters configuration. For the requests processed on this interface will use iWAG Access Accept configuration use case template.

Figure 42: iWAG PEP Configuration

iWAG

<p>*Name <input type="text" value="default"/></p> <p>Default Shared Secret <input type="text" value="cisco"/></p> <p>*CoA Port <input type="text" value="1700"/></p> <p>*CoA Timeout Seconds <input type="text" value="3"/></p> <p>*Access Request Guard Timer (Milliseconds) <input type="text" value="0"/></p> <p>Disconnect Template <input type="text" value=""/> <input type="checkbox"/> Dup Check With Framed Ip <input type="checkbox"/> Radius Network Session Correlation</p>	<p>Description <input type="text"/></p> <p>Default CoA Shared Secret <input type="text" value="cisco"/></p> <p>*CoA Retries <input type="text" value="3"/></p> <p>Correlation Key <input type="text" value="AccountSessionId"/></p> <p>Coa Disconnect Template <input type="text" value=""/> <input type="button" value="select"/> <input type="button" value="clear"/></p> <p>Proxy Access Accept Filter <input type="text" value=""/> <input type="checkbox"/> Dup Check With Mac Address <input checked="" type="checkbox"/> Control Session Lifecycle</p>
---	---

Devices

*IP Address or IP Range (CIDR notation)	Shared Secret	CoA Shared Secret	Loopback Addresses
1.1.1.1	cisco	cisco	

215131

To make a sample call using iWAG PEP, perform the following steps:

- Step 1** Configure the radius plug-in in **Reference Data** tab > **System** > **Plugin Configuration** > **Radius Configuration**.
- Step 2** Configure the PEP as explained above for iWAG.
- Step 3** Configure the domain as explained in Domains chapter in this book. For example, select USuM Authorization type of authorization.
- Step 4** Configure the service, this service must use the iWAG Template listed below.

Figure 43: iWAG Template

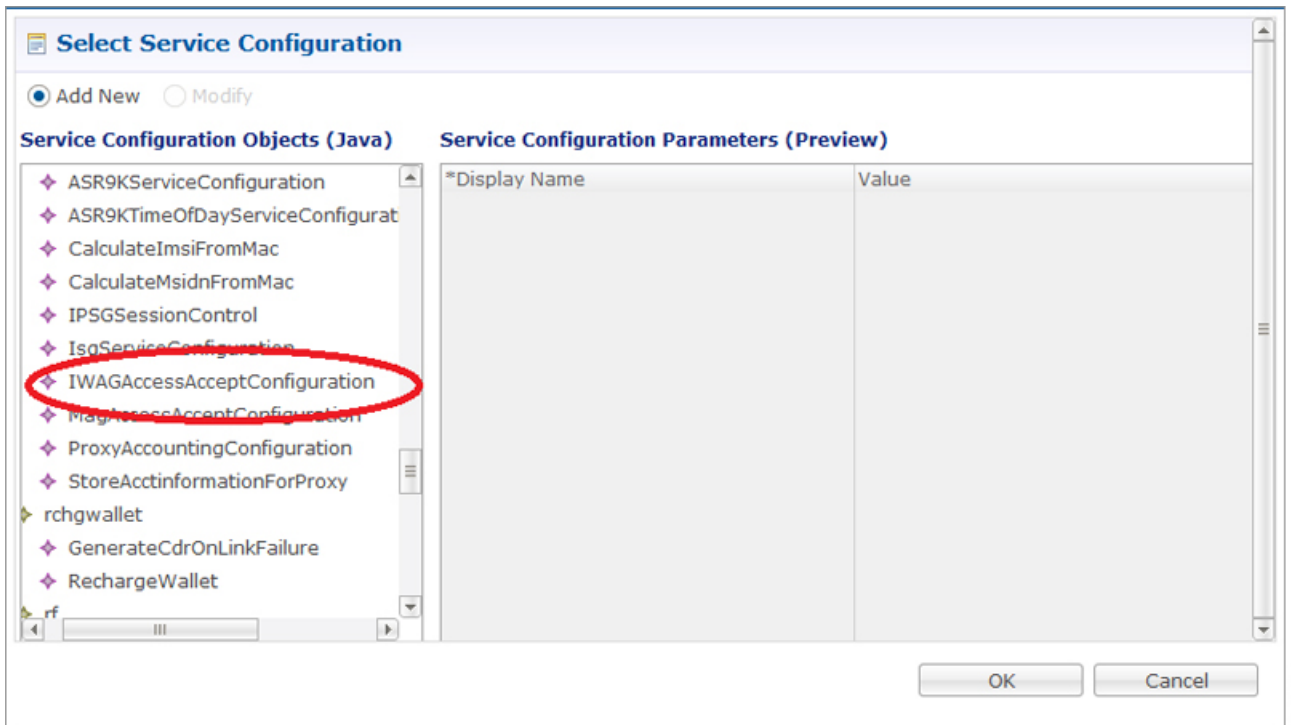

Configuring Access Accept Templates for iWAG

For configuring the Access Accept Template for iWAG, create a child in iWAG Access Accept Template and configure as shown below. This configuration is same as any other Access Accept template we have.

Figure 44: Access Accept Templates for iWAG



Configuring Use Case Template for iWAG Access Accept

Create a Use Case Template for iWAG Access Accept Configuration in Services tab as shown below:

Figure 45: Use Case Template for iWAG Access Accept

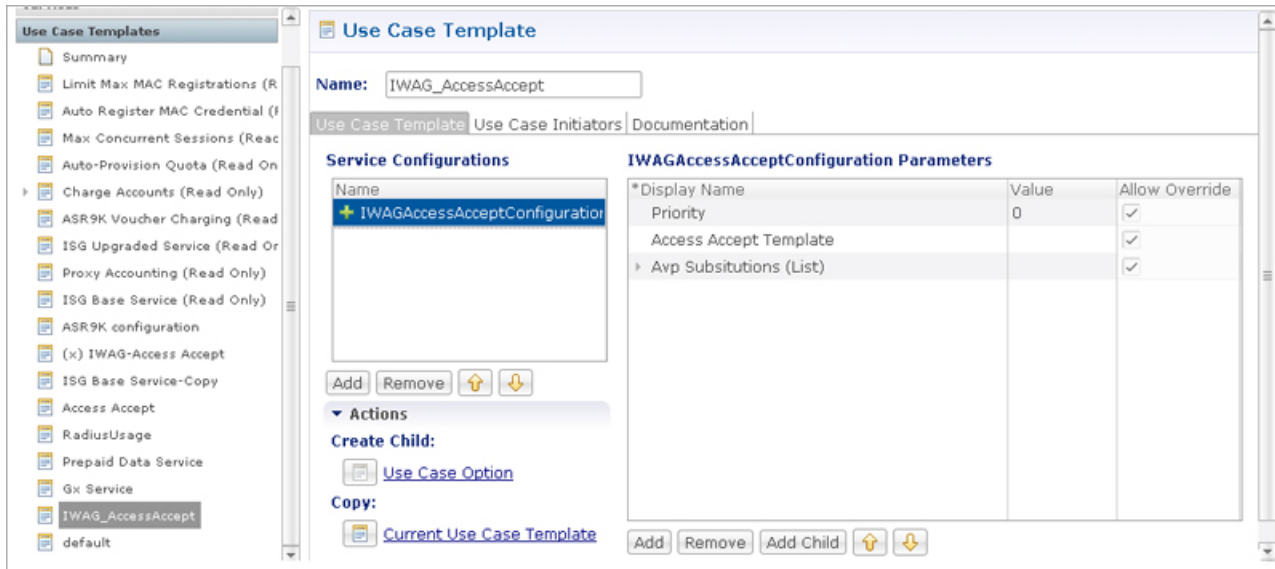

iWAG-Service Option Configuration

Create a service options using the Use Case Template created for iWAG in the previous section as shown below:

Figure 46: iWAG-Service Option Configuration

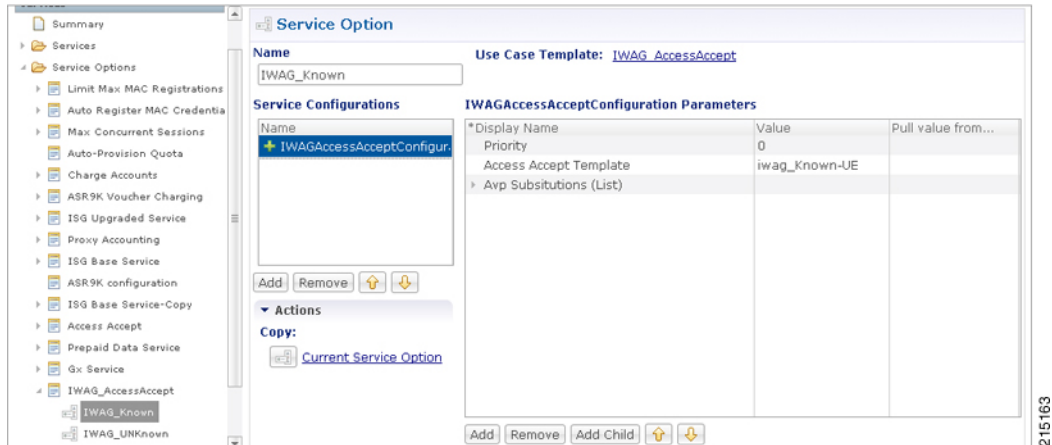

Create a Service which uses the service options which was created in the previous step as shown below.

Figure 47: Create a Service

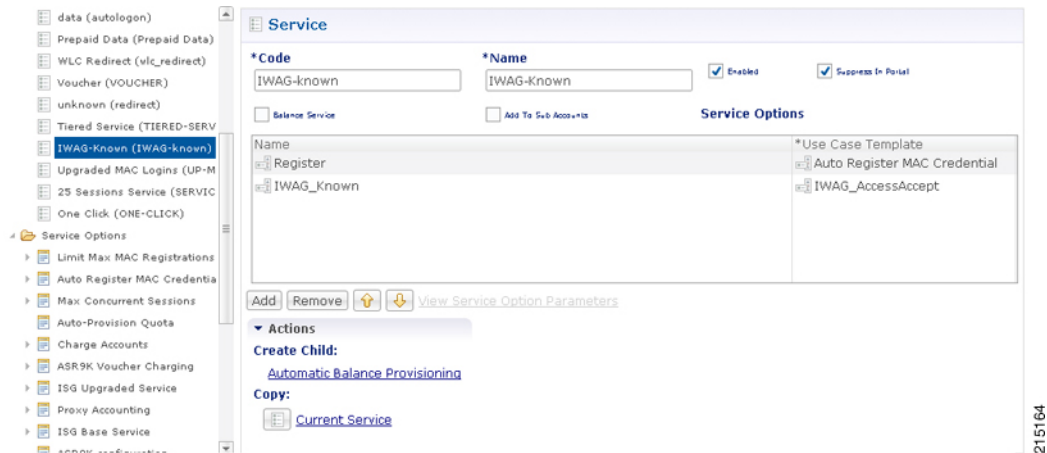

Publish the configuration and associate this service with the subscriber in Control Center.

iWAG Call Flow

Figure 48: iWAG based Decoupled Web-Auth - 1

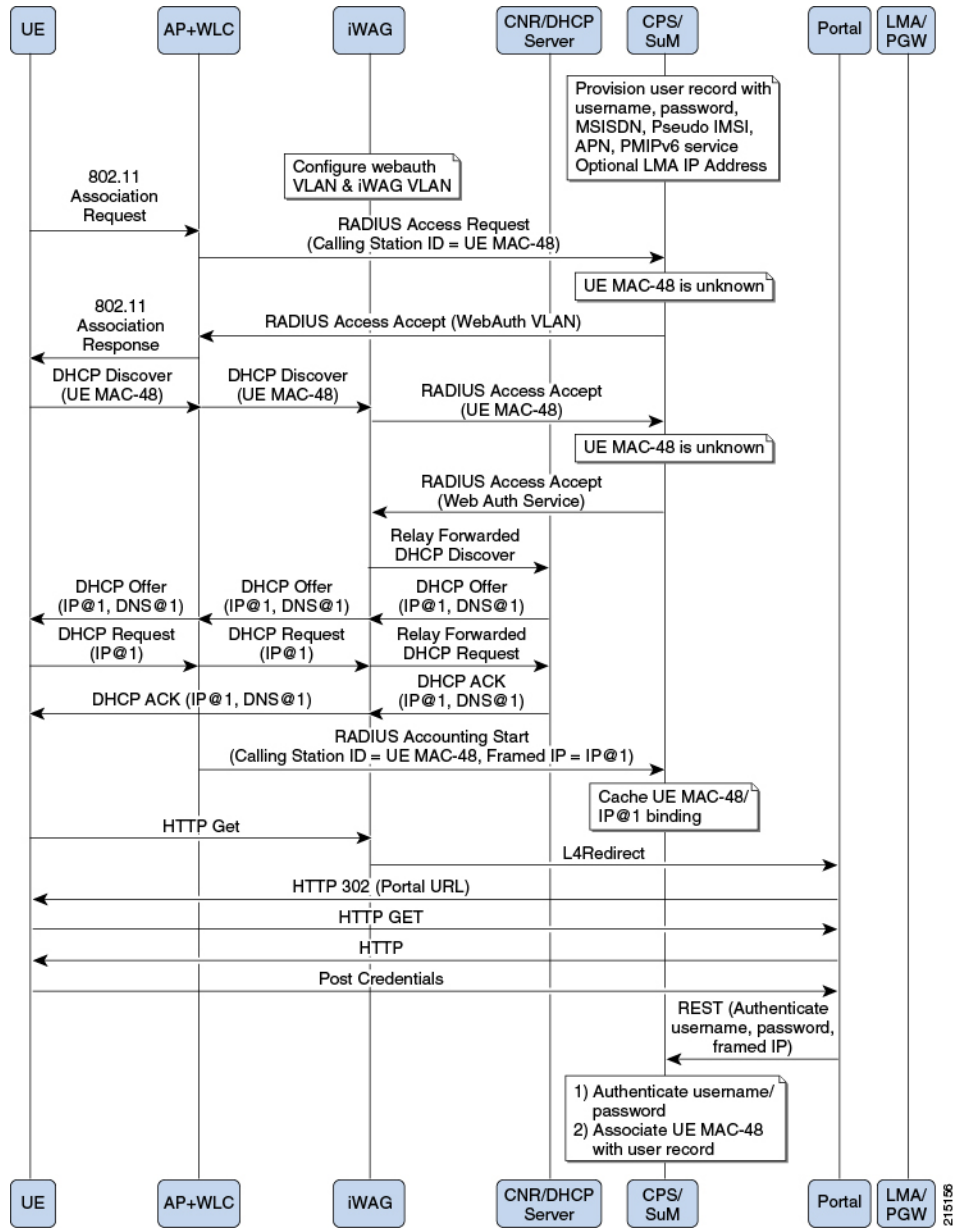
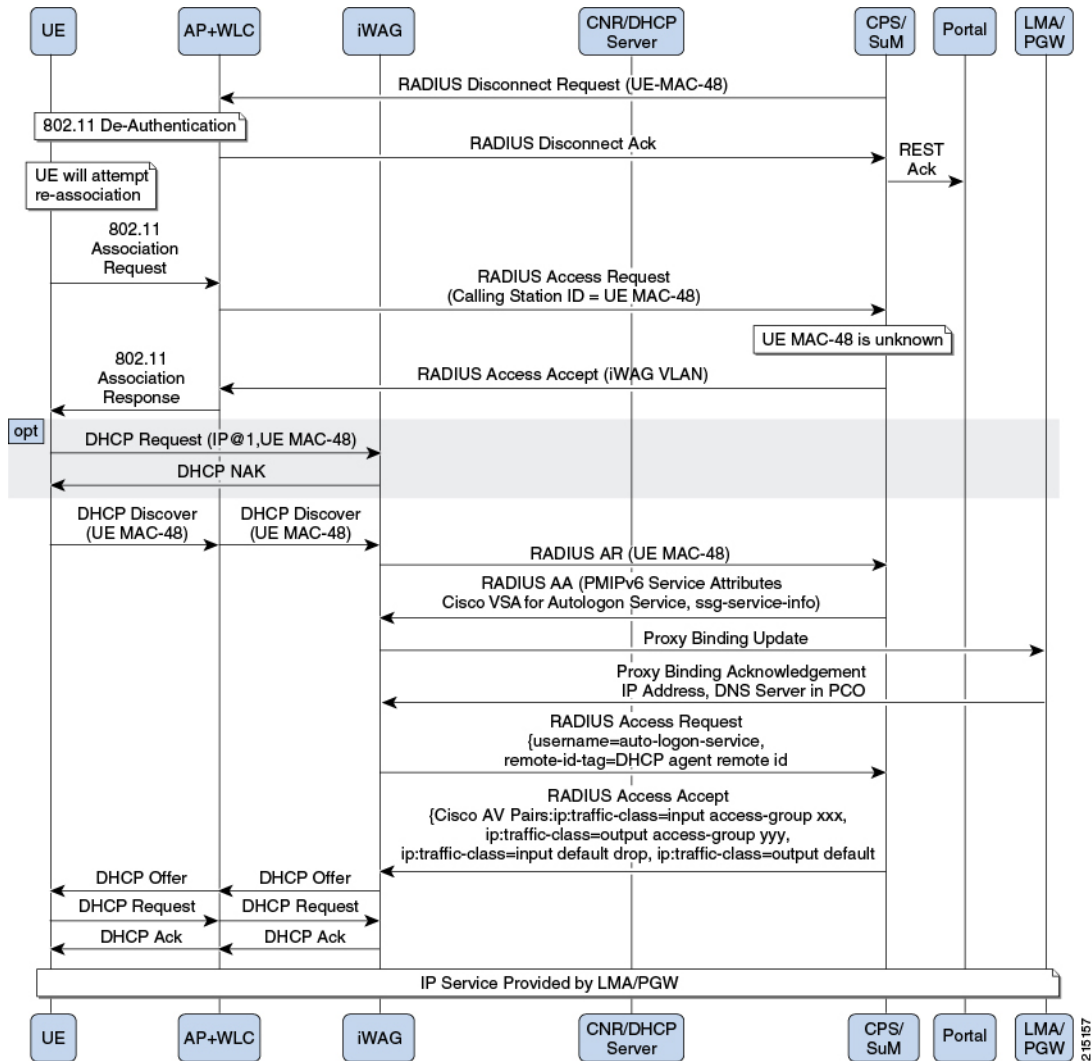

Figure 49: iWAG based Decoupled Web-Auth - 2



Cisco WLCs

In the **Cisco WLCs Summary** window, click **Cisco WLC** under **Create Child** to create a new WLC pool.

Figure 50: Cisco WLCs

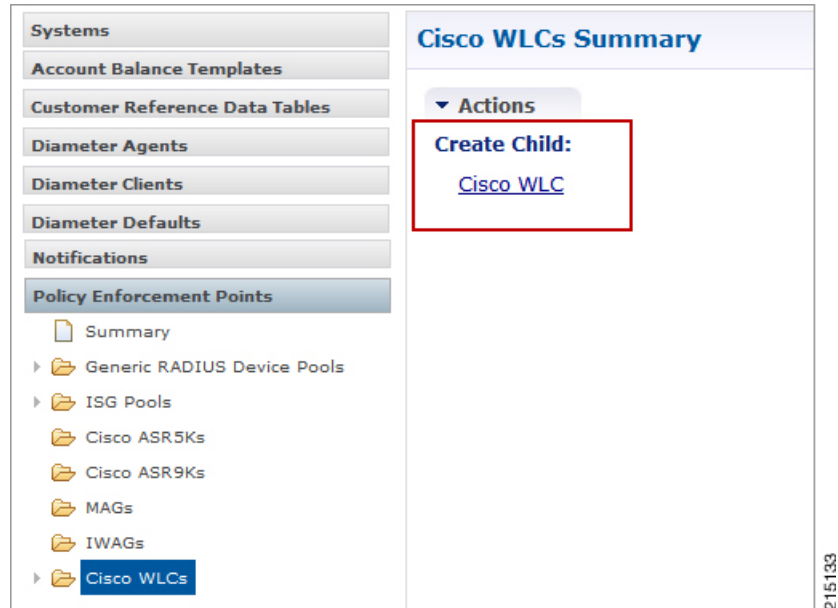

The default WLC is shown below.

Figure 51: Default WLC

Cisco WLC

<p>*Name <input type="text" value="default"/></p> <p>Default Shared Secret <input type="text"/></p> <p>*CoA Port <input type="text" value="1700"/></p> <p>*CoA Timeout Seconds <input type="text" value="3"/></p> <p>*Access Request Guard Timer (Milliseconds) <input type="text" value="0"/></p> <p>Disconnect Template <input type="text"/> <input type="button" value="select"/> clear</p> <p>Coa Login Template <input type="text"/> <input type="button" value="select"/> clear</p> <p><input type="checkbox"/> Dup Check With Mac Address</p> <p><input checked="" type="checkbox"/> Control Session Lifecycle</p> <p><input type="checkbox"/> Send To Policy Intel</p> <p><input type="checkbox"/> Disconnect On Web Login</p>	<p>Description <input type="text"/></p> <p>Default CoA Shared Secret <input type="text"/></p> <p>*CoA Retries <input type="text" value="3"/></p> <p>Correlation Key <input type="text" value="AccountSessionId"/></p> <p>Coa Disconnect Template <input type="text"/> <input type="button" value="select"/> clear</p> <p>Proxy Access Accept Filter <input type="text"/> <input type="button" value="select"/> clear</p> <p><input type="checkbox"/> Dup Check With Framed Ip</p> <p><input type="checkbox"/> Radius Network Session Correlation</p> <p><input type="checkbox"/> Track Locations</p> <p><input type="checkbox"/> Send To Policy Engine</p>
--	--

Devices

*IP Address or IP Range (CIDR notation)	Shared Secret	CoA Shared Secret	Loopback Addresses

215099

In the Devices section, enter the IP Address or IP Range (CIDR notation). To add an IP Range, click Add. By default, the IP Range is 0.0.0.0. Edit the IP Range according to your requirements in the CIDR notation by clicking on the default value as shown in the example.

Figure 52: IP Range

Cisco WLC

<p>*Name <input type="text" value="WLC"/></p> <p>Default Shared Secret <input type="text" value="cisco"/></p> <p>*CoA Port <input type="text" value="1700"/></p> <p>*CoA Timeout Seconds <input type="text" value="3"/></p> <p>*Access Request Guard Timer (Milliseconds) <input type="text" value="0"/></p> <p>Disconnect Template <input type="text" value=""/> select clear</p> <p>Coa Login Template <input type="text" value=""/> select clear</p> <p><input type="checkbox"/> Dup Check With Mac Address</p> <p><input checked="" type="checkbox"/> Control Session Lifecycle</p> <p><input checked="" type="checkbox"/> Send To Policy Intel</p> <p><input checked="" type="checkbox"/> Disconnect On Web Login</p>	<p>Description <input type="text" value="WLC for Quality Assurance"/></p> <p>Default CoA Shared Secret <input type="text" value="cisco"/></p> <p>*CoA Retries <input type="text" value="3"/></p> <p>Correlation Key <input type="text" value="callingStationId"/></p> <p>Coa Disconnect Template <input type="text" value=""/> select clear</p> <p>Proxy Access Accept Filter <input type="text" value=""/> select clear</p> <p><input type="checkbox"/> Dup Check With Framed Ip</p> <p><input type="checkbox"/> Radius Network Session Correlation</p> <p><input type="checkbox"/> Track Locations</p> <p><input type="checkbox"/> Send To Policy Engine</p>
---	--

Devices

*IP Address or IP Range (CIDR notation)	Shared Secret	CoA Shared Secret	Loopback Addresses
10.10.10.10/24	cisco	cisc	192.168.3.0/24

215134

Enter the value for Shared Secret and CoA Shared Secret by selecting the blank row of the column respectively. If the IP Range in one device definition overrides with any other IP Range or any IP Address in the same or other device definitions, the Policy Builder performs a validation check and displays suitable error messages against the Policy Enforcement Point, which has an overlapping IP range. Most of the parameters are already covered in Generic Radius Device Pool and some of the new parameters are described in the following table:

Table 4: WLC Parameters

Parameter	Description
Coa Login Template	Upon successful Web authentication, CPS can send the Re-auth CoA to the right WLC (based on NAS IP) and include the correct session id for the subscriber in the CoA Request.
Track Locations	This defines enhanced location mapping feature of the client. It will track the AP or SSID location of the client and will be stored as a location in the mongo radius database.
Send To Policy Intel	This defines that radius events are sent to policy server for tracking and generate event for records.
Send To Policy Engine	Selecting this check box will send radius messages to CPS or Policy engine. If we are using ISG in between, then uncheck this check box.
Disconnect on Web Login	Selecting this check box will send radius disconnect request and terminate the session when the user for the first time does the successfully web login to portal.

Configuration and Restrictions

- Configuration of Loopback Address in CIDR notation is not supported.
- If a Loopback Address is configured, the corresponding IP Address column should have a single IP Address and not a range of IP Address. This leads to an incorrect configuration.

Example - CPS Configuration for Web-Auth Call Flow

Call Flows

Figure 53: WLC-CPS Integration - Central Web Authentication

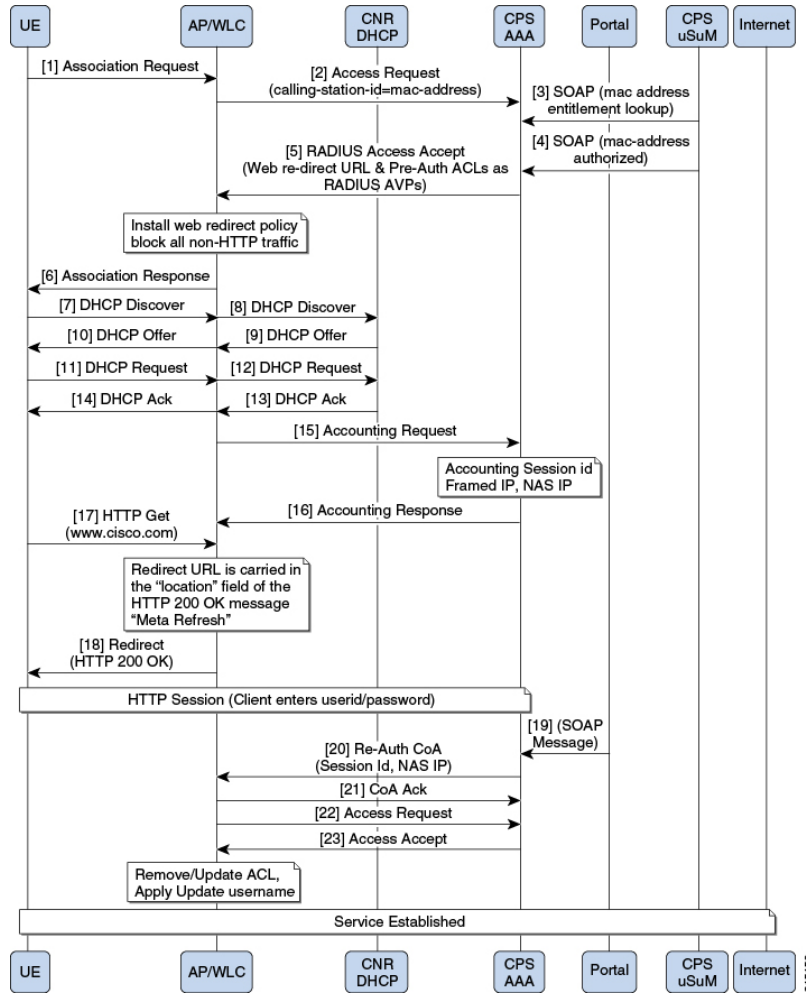
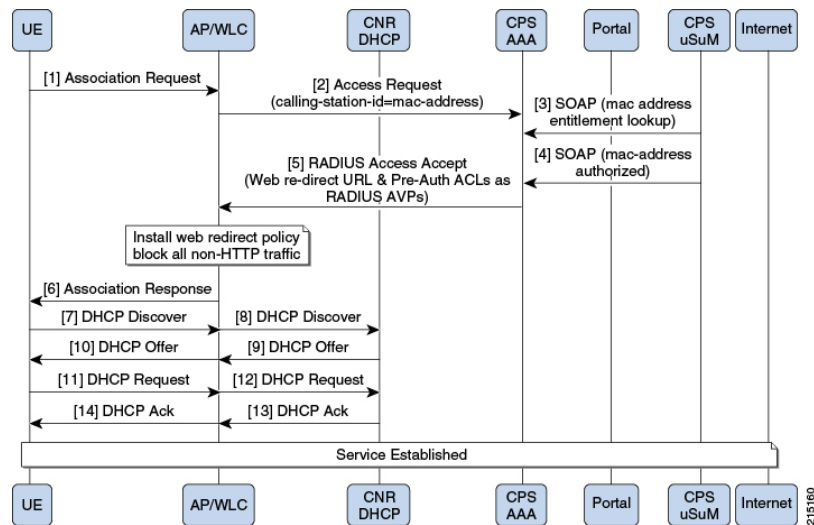

Figure 54: MAC-TAL



Policy Builder Configuration

Cisco WLC Configuration

Configure WLCs for policy enforcement points in CPS. The configuration includes configuring WLC IPs and any loopback interfaces used in WLC configuration. The shared secret needs to match with what is configured on WLC.

Radius Templates Configuration

Radius service templates for WLC services are used to define all the services CPS will send as access-accept for the requests received from WLC.

Step 1

Cisco redirect services will define the AV pair values for redirect to a portal and access-lists used for redirecting subscriber traffic.

Figure 55: WLC Redirect Service

The screenshot shows the configuration page for a RADIUS Service. On the left is a navigation tree with 'RADIUS Service Templates' selected, and 'wlc_redirect' highlighted under the 'WLC' folder. The main content area is titled 'RADIUS Service' and includes the following elements:

- *Name:** wlc_redirect
- Base Template:** (empty field)
- AV Table:**

Vendor	*Name	Value	Tag	Type
CISCO	AVPAIR	url-redirect-acl=ACL-REDIRECT		String
CISCO	AVPAIR	url-redirect=http://10.225.115.24		String
- AV Pair Table:**

*Name	Replacement String	Associated AV Pairs
- Actions:**
 - Copy: [Current RADIUS Service Template](#)

215135

Step 2 Define CoA services for subscriber sessions. Upon successful Web Auth, CPS sends the CoA login to WLC for the subscriber session.

Figure 56: CoA Services

The screenshot displays the configuration interface for a RADIUS Service on a Cisco WLC. The left-hand navigation menu includes categories such as Systems, Account Balance Templates, Andsf Clients, Custom Reference Data Tables, DM Configuration, Diameter Agents, Diameter Clients, Diameter Defaults, Fault List, Notifications, Policy Enforcement Points, Policy Reporting, RADIUS Service Templates, and Subscriber Data Sources. The RADIUS Service Templates section is expanded to show various templates, with 'coa_login' selected under the WLC category.

The main configuration area for the RADIUS Service is titled 'RADIUS Service' and includes the following sections:

- *Name:** coa_login
- Base Template:** (empty field)
- AV:** A table listing AV pairs with columns for Vendor, *Name, Value, Tag, and Type.

Vendor	*Name	Value	Tag	Type
CISCO	AVPAIR	subscriber:command=reauthenticate		String
CISCO	AVPAIR	subscriber:reauthenticate-type=last		String
CISCO	AVPAIR	audit-session-id=\$audit-session-id		String
<Radius>	NAS-IP-ADDRESS	10.225.115.23		Ipaddr
- Show Available AV Pair Attributes To:** (expanded)
- AV Pair:** A table listing AV pairs with columns for *Name, Replacement String, and Associated AV Pairs.

*Name	Replacement String	Associated AV Pairs
Cisco Audit Session	\$audit-session-id	1 pairs selected
- Actions:** A section with a 'Copy:' button and a link to 'Current RADIUS Service Template'.

215137

Step 3 Username template to be sent after the client get authenticated via portal. We can configure any information needed to be sent to WLC process

Figure 57: Username Template

The screenshot displays the configuration page for a RADIUS Service Template. On the left is a navigation sidebar with categories like Systems, Account Balance Templates, and RADIUS Service Templates. The main area is titled 'RADIUS Service' and includes fields for '*Name' (username) and 'Base Template'. Below this is an 'AV' table with columns for Vendor, *Name, Value, Tag, and Type. A section for 'AV Pair' shows a table with columns for *Name, Replacement String, and Associated AV Pairs. The 'AV Pair' table contains one entry: Username, \$userName, and 1 pairs selected. There are also 'Add' and 'Remove' buttons, and an 'Actions' section with a 'Copy' button for the 'Current RADIUS Service Template'.

Vendor	*Name	Value	Tag	Type
<Radius>	USER-NAME	\$userName		String

*Name	Replacement String	Associated AV Pairs
Username	\$userName	1 pairs selected

215138

Domain Configuration

Configure a Domain “web-auth” for the subscribers and authorizations based on session username and User Password and set this domain as Default Domain.

Figure 58: Web-Auth Domain

The screenshot shows the 'Domain' configuration page for 'web-auth'. The 'Name' field contains 'web-auth' and the 'Is Default' checkbox is checked. The 'Authorization' dropdown is set to 'USuM Authorization'. Under 'User Id Field', 'Session User Name' is selected. Under 'Password Field', 'User Password' is selected. The 'Remote Db Lookup Key Field' is empty. The '*Domain Naming' section has an empty 'Domain Prefix' field and the 'Append Location' checkbox is unchecked. The tabs 'General', 'Provisioning', 'Additional Profile Data', 'Locations', and 'Advanced Rules' are visible, with 'General' being the active tab.

Define locations based on Framed IP location type.

Figure 59: Framed IP Location Type

The screenshot shows the 'Domain' configuration page for 'web-auth' with the 'Locations' tab selected. The 'Name' field contains 'web-auth' and the 'Is Default' checkbox is checked. The '*Location Matching Type' dropdown is set to 'Framed IP Location Type'. Below this is a table for 'Location Matching Type' with columns 'Name', 'Mapping Values', and 'Timezone'. The table is currently empty. Below the table are 'Add', 'Remove', and two arrow buttons (up and down). Under the 'Actions' section, there is a 'Create Child:' link pointing to 'Service Provider'. The page number '00' is visible in the bottom right corner.

Name	Mapping Values	Timezone

Set Advanced Rules For the MAC TAL.

Figure 60: Advanced Rules

The screenshot shows the configuration interface for a Domain named 'web-auth'. The 'Advanced Rules' tab is active. Key settings include:

- Name:** web-auth (with a checked 'Is' checkbox).
- Transparent Auto-Login (TAL) Type:** Session Mac Address (with 'select' and 'clear' buttons). A 'Tal With No' checkbox is present.
- EAP Correlation Attribute:** (with 'select' and 'clear' buttons). An 'Imsi To Mac Format' checkbox is present.
- Unknown Service:** WLC Redirect Service (wlc_redir) (with 'select' and 'clear' buttons). An 'Autodelete Expired Users' checkbox is checked.
- Default Service:** (with 'select' and 'clear' buttons).
- Anonymous Subscriber Service:** (with 'select' and 'clear' buttons).
- Authentication:** A collapsed section with a checkbox.
- Actions:**
 - Create Child:** [Service Provider](#)
 - Copy:** [Current Domain](#)

215141

Service Configuration: Use Case Template

Configure use Case Templates as “AccessAccept” and map the Service configuration Objects (Radius) “AccessAcceptConfiguration” from the Service Configurations pop-up dialog box.

- AccessAccept template configuration

Figure 61: AccessAccept Template

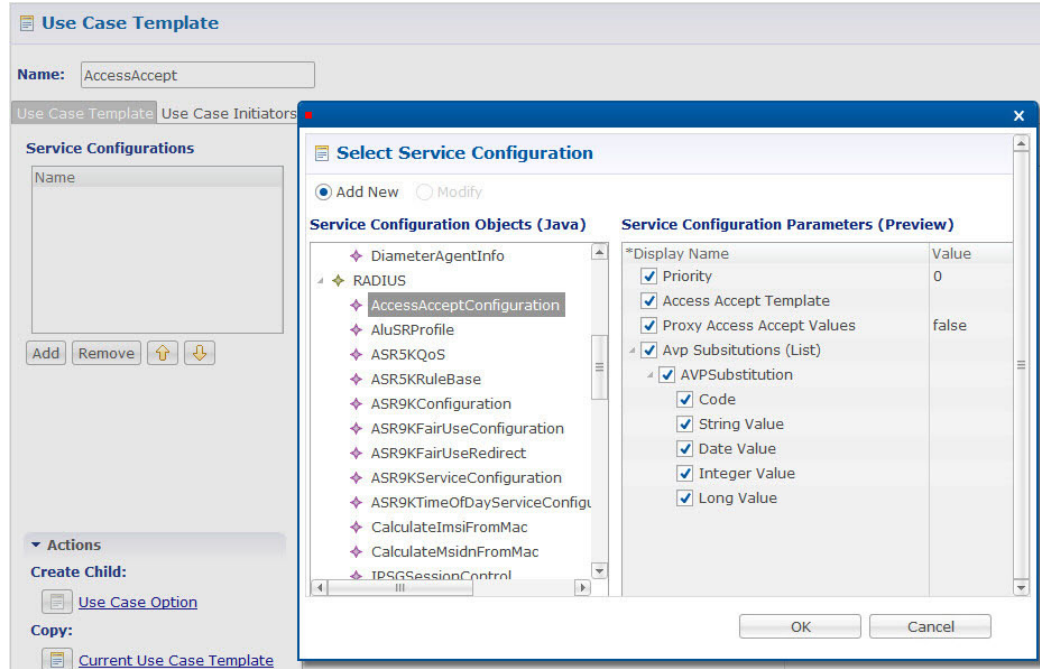

Service Options

Based on above Use Case Templates, configure Service Options “wlc redirect” and “username”.

- wlc-Redirect service-option configuration

Figure 62: wlc-Redirect Service Option

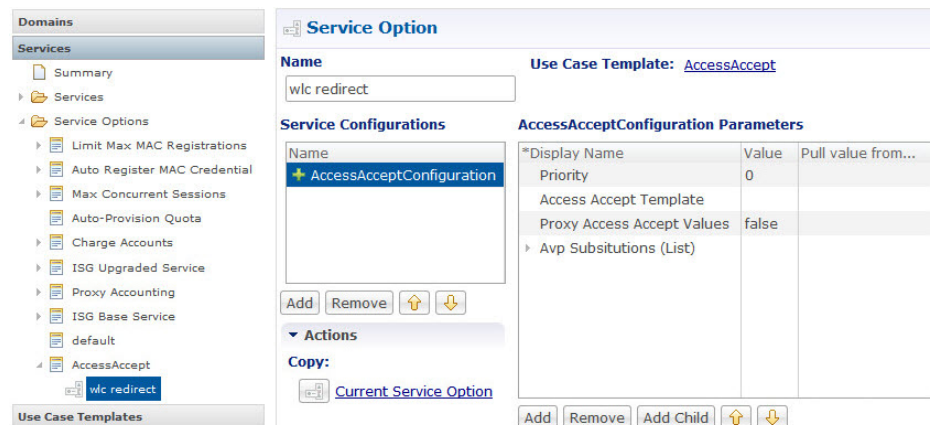

- “username” Service Options Configuration

Figure 63: username Service Option

Service Option

Name: Use Case Template: [AccessAccept](#)

Service Configurations

Name:

AccessAcceptConfiguration Parameters

*Display Name	Value	Pull value from...
Priority	0	
Access Accept Template		
Proxy Access Accept Values	false	
Avp Substitutions (List)		

Buttons: Add, Remove, Up, Down, Copy: [Current Service Option](#)

- “6-Hours MAC Limit” Auto Register MAC Credential Service Options configuration

Figure 64: 6-Hours MAC Limit

Service Option

Name: Use Case Template: [Auto Register MAC Credential](#)

Service Configurations

Name:

Registration Limit Parameters

*Display Name	Value	Pull value from...
Duration	6	
Duration Type	Hours	

Buttons: Add, Remove, Up, Down, Copy: [Current Service Option](#)

Service

Create a Service that will be assigned to the user account when the user connects for the first time and MAC TAL fails then assign an Unknown Service. For example, wlc-redirect.

Figure 65: wlc-redirect

The screenshot shows the Cisco WLC configuration interface. On the left, a navigation pane shows 'Domains' and 'Services'. Under 'Services', 'Service A (SERVICE_A)' is expanded, and 'wlc redirect (wlc redirect)' is selected. The main area displays the configuration for this service:

- *Code:** wlc redirect
- *Name:** wlc redirect
- Enabled
- Suppress In Portal
- Balance Service
- Add To Sub Accounts
- Service Options:**
 - Name: wlc redirect
 - *Use Case Template: AccessAccept

At the bottom, there are buttons for 'Add', 'Remove', and 'View Service Option Parameters'.

Create a Service that will be assigned to the user account in the uSuM.

Figure 66: Service

The screenshot shows the Cisco WLC configuration interface. On the left, a navigation pane shows 'Domains' and 'Services'. Under 'Services', 'Service A (SERVICE_A)' is expanded, and 'wlc_access_accept (wlc_access_...' is selected. The main area displays the configuration for this service:

- *Code:** wlc_access_accept
- *Name:** wlc_access_accept
- Enabled
- Suppress In Portal
- Balance Service
- Add To Sub Accounts
- Service Options:**
 - Name: username
 - *Use Case Template: AccessAccept
 - 6 Hour Limit
 - Auto Register MAC Credential

At the bottom, there are buttons for 'Add', 'Remove', and 'View Service Option Parameters'.

Control Center

Create subscribers in USuM database and add service type applicable to the subscriber. For more information on control center configuration, refer to [Control Center Configuration](#), on page 31.