



## **Cisco Wireless Mesh Access Points, Design and Deployment Guide, Release 7.4**

**First Published:** December 07, 2012

**Last Modified:** June 30, 2013

### **Americas Headquarters**

Cisco Systems, Inc.  
170 West Tasman Drive  
San Jose, CA 95134-1706  
USA  
<http://www.cisco.com>  
Tel: 408 526-4000  
800 553-NETS (6387)  
Fax: 408 527-0883

Text Part Number: OL-28135-01

THE SPECIFICATIONS AND INFORMATION REGARDING THE PRODUCTS IN THIS MANUAL ARE SUBJECT TO CHANGE WITHOUT NOTICE. ALL STATEMENTS, INFORMATION, AND RECOMMENDATIONS IN THIS MANUAL ARE BELIEVED TO BE ACCURATE BUT ARE PRESENTED WITHOUT WARRANTY OF ANY KIND, EXPRESS OR IMPLIED. USERS MUST TAKE FULL RESPONSIBILITY FOR THEIR APPLICATION OF ANY PRODUCTS.

THE SOFTWARE LICENSE AND LIMITED WARRANTY FOR THE ACCOMPANYING PRODUCT ARE SET FORTH IN THE INFORMATION PACKET THAT SHIPPED WITH THE PRODUCT AND ARE INCORPORATED HEREIN BY THIS REFERENCE. IF YOU ARE UNABLE TO LOCATE THE SOFTWARE LICENSE OR LIMITED WARRANTY, CONTACT YOUR CISCO REPRESENTATIVE FOR A COPY.

The Cisco implementation of TCP header compression is an adaptation of a program developed by the University of California, Berkeley (UCB) as part of UCB's public domain version of the UNIX operating system. All rights reserved. Copyright © 1981, Regents of the University of California.

NOTWITHSTANDING ANY OTHER WARRANTY HEREIN, ALL DOCUMENT FILES AND SOFTWARE OF THESE SUPPLIERS ARE PROVIDED "AS IS" WITH ALL FAULTS. CISCO AND THE ABOVE-NAMED SUPPLIERS DISCLAIM ALL WARRANTIES, EXPRESSED OR IMPLIED, INCLUDING, WITHOUT LIMITATION, THOSE OF MERCHANTABILITY, FITNESS FOR A PARTICULAR PURPOSE AND NON-INFRINGEMENT OR ARISING FROM A COURSE OF DEALING, USAGE, OR TRADE PRACTICE.

IN NO EVENT SHALL CISCO OR ITS SUPPLIERS BE LIABLE FOR ANY INDIRECT, SPECIAL, CONSEQUENTIAL, OR INCIDENTAL DAMAGES, INCLUDING, WITHOUT LIMITATION, LOST PROFITS OR LOSS OR DAMAGE TO DATA ARISING OUT OF THE USE OR INABILITY TO USE THIS MANUAL, EVEN IF CISCO OR ITS SUPPLIERS HAVE BEEN ADVISED OF THE POSSIBILITY OF SUCH DAMAGES.

Any Internet Protocol (IP) addresses and phone numbers used in this document are not intended to be actual addresses and phone numbers. Any examples, command display output, network topology diagrams, and other figures included in the document are shown for illustrative purposes only. Any use of actual IP addresses or phone numbers in illustrative content is unintentional and coincidental.

Cisco and the Cisco logo are trademarks or registered trademarks of Cisco and/or its affiliates in the U.S. and other countries. To view a list of Cisco trademarks, go to this URL: <http://www.cisco.com/go/trademarks>. Third-party trademarks mentioned are the property of their respective owners. The use of the word partner does not imply a partnership relationship between Cisco and any other company. (1110R)

© 2012 Cisco Systems, Inc. All rights reserved.



## CONTENTS

---

### Preface

#### Preface xi

Audience xii

Organization xii

Conventions xii

Related Documentation xv

Obtaining Documentation and Submitting a Service Request xv

---

### CHAPTER 1

#### Mesh Network Components 1

Mesh Access Points 1

Licensing for Mesh Access Points on a 5500 Series Controller 1

Access Point Roles 2

Network Access 3

Network Segmentation 4

Cisco Indoor Mesh Access Points 4

Cisco Outdoor Mesh Access Points 5

Cisco Aironet 1552 Mesh Access Point 6

Cisco 1522 Mesh Access Point 12

Cisco 1524PS Mesh Access Point 12

Cisco 1524SB Mesh Access Point 12

Ethernet Ports 15

Multiple Power Options 15

Battery Backup Module (Optional) 17

Reset Button 17

Resetting Access Point 19

Monitoring the LED Status 19

Serial Backhaul Access Point Guidelines for the Rest of the World (ROW) 22

Discontinuation of the 116 and 132 Channels from the UNII-2 Extended Band 24

Frequency Bands	25
Dynamic Frequency Selection	26
Antennas	27
Antenna Configurations for 1552	32
Client Access Certified Antennas (Third-Party Antennas)	35
Maximum Ratio Combining	35
Cisco 1500 Hazardous Location Certification	38
Cisco Wireless LAN Controllers	41
Cisco Prime Infrastructure	41
Architecture	41
Control and Provisioning of Wireless Access Points	41
CAPWAP Discovery on a Mesh Network	41
Dynamic MTU Detection	42
XML Configuration File	42
Adaptive Wireless Path Protocol	43
Traffic Flow	44
Mesh Neighbors, Parents, and Children	45
Criteria to Choose the Best Parent	46
Ease Calculation	46
Parent Decision	46
SNR Smoothing	47
Loop Prevention	47

---

**CHAPTER 2**

<b>Mesh Deployment Modes</b>	<b>49</b>
Wireless Mesh Network	49
Wireless Backhaul	49
Universal Access	50
Point-to-Multipoint Wireless Bridging	50
Point-to-Point Wireless Bridging	51
Configuring Mesh Range (CLI)	52
Assumptions for the AP1522 Range Calculator	52
Assumptions for the AP1552 Range Calculator	52

---

**CHAPTER 3**

<b>Design Considerations</b>	<b>55</b>
Wireless Mesh Constraints	55



Wireless Backhaul Data Rate	55
ClientLink Technology	59
Configuring ClientLink (CLI)	61
Commands Related to ClientLink	62
Controller Planning	62

---

**CHAPTER 4****Site Preparation and Planning 65**

Site Survey	65
Pre-Survey Checklist	65
Outdoor Site Survey	66
Determining a Line of Sight	66
Weather	67
Fresnel Zone	67
Fresnel Zone Size in Wireless Mesh Deployments	68
Hidden Nodes Interference	69
Functional Routing of Three Radio MAPs	70
Slot Bias Options	70
Disabling Slot Bias	71
Commands Related to Slot Bias	71
Preferred Parent Selection	72
Preferred Parent Selection Criteria	72
Configuring a Preferred Parent	73
Related Commands	73
Co-Channel Interference	75
Wireless Mesh Network Coverage Considerations	75
Cell Planning and Distance	75
Assumptions for the AP1522 Range Calculator	87
Assumptions for the AP1552 Range Calculator	88
Collocating Mesh Access Points	90
Special Considerations for Indoor Mesh Networks	91
Wireless Propagation Characteristics	93
CleanAir	93
CleanAir AP Modes of Operation	94
Pseudo MAC (PMAC) and Merging	95
Event Driven Radio Resource Management and Persistence Device Avoidance	96

CleanAir Access Point Deployment Recommendations	96
CleanAir Advisor	97
Enabling CleanAir	98
Licensing	98
Wireless Mesh Mobility Groups	98
Multiple Controllers	99
Increasing Mesh Availability	99
Multiple RAPS	100
Indoor Mesh Interoperability with Outdoor Mesh	101

**CHAPTER 5****Connecting the Cisco 1500 Series Mesh Access Points to the Network 103**

Adding Mesh Access Points to the Mesh Network	104
Adding MAC Addresses of Mesh Access Points to MAC Filter	105
Adding the MAC Address of the Mesh Access Point to the Controller Filter List (GUI)	105
Adding the MAC Address of the Mesh Access Point to the Controller Filter List (CLI)	106
Defining Mesh Access Point Role	106
General Notes about MAP and RAP Association With The Controller	106
Configuring the AP Role (GUI)	107
Configuring the AP Role (CLI)	108
Configuring Multiple Controllers Using DHCP 43 and DHCP 60	108
Backup Controllers	109
Configuring Backup Controllers (GUI)	110
Configuring Backup Controllers (CLI)	111
Configuring External Authentication and Authorization Using a RADIUS Server	113
Configuring RADIUS Servers	114
Adding a Username to a RADIUS Server	115
Enabling External Authentication of Mesh Access Points (GUI)	116
Enable External Authentication of Mesh Access Points (CLI)	116
View Security Statistics (CLI)	117
Configuring Global Mesh Parameters	117
Configuring Global Mesh Parameters (GUI)	117
Configuring Global Mesh Parameters (CLI)	120
Viewing Global Mesh Parameter Settings (CLI)	121

Backhaul Client Access	122
Configuring Backhaul Client Access (GUI)	123
Configuring Backhaul Client Access (CLI)	123
Backhaul Client Access on Serial Backhaul Access Points	123
Configuring Extended Universal Access (GUI)	124
Configuring Extended Universal Access (CLI)	126
Configuring Extended Universal Access from Cisco Prime Infrastructure	127
Configuring Local Mesh Parameters	128
Configuring Wireless Backhaul Data Rate	128
Configuring Ethernet Bridging	135
Enabling Ethernet Bridging (GUI)	137
Configuring Bridge Group Names	137
Configuring Bridge Group Names (CLI)	138
Verifying Bridge Group Names (GUI)	138
Configuring Public Safety Band Settings	138
Configuring Interoperability with Cisco 3200	140
Enabling AP1522 to Associate with Cisco 3200 (GUI)	142
Enabling 1522 and 1524PS Association with Cisco 3200 (CLI)	142
Configuring Power and Channel Settings	143
Configuring Power and Channel Settings (GUI)	143
Configuring the Channels on the Serial Backhaul (CLI)	144
Configuring Antenna Gain	145
Configuring Antenna Gain (GUI)	145
Configuring Antenna Gain (CLI)	145
Backhaul Channel Deselection on Serial Backhaul Access Point	145
Configuring Backhaul Channel Deselection (GUI)	146
Configuring Backhaul Channel Deselection (CLI)	147
Backhaul Channel Deselection Guidelines	150
Configuring Dynamic Channel Assignment	151
Configuring Advanced Features	153
Using the 2.4-GHz Radio for Backhaul	154
Configuring Ethernet VLAN Tagging	155
Ethernet Port Notes	156
Ethernet VLAN Tagging Guidelines	157
VLAN Registration	159

Enabling Ethernet VLAN Tagging (GUI)	159
Configuring Ethernet VLAN Tagging (CLI)	160
Viewing Ethernet VLAN Tagging Configuration Details (CLI)	161
Workgroup Bridge Interoperability with Mesh Infrastructure	161
Configuring Workgroup Bridges	162
Guidelines for Configuration	165
Configuration Example	166
WGB Association Check	168
Link Test Result	170
WGB Wired/Wireless Client	171
Client Roaming	172
WGB Roaming Guidelines	172
Configuration Example	173
Troubleshooting Tips	174
Configuring Voice Parameters in Indoor Mesh Networks	174
Call Admission Control	175
Quality of Service and Differentiated Services Code Point Marking	175
Guidelines For Using Voice on the Mesh Network	180
Voice Call Support in a Mesh Network	182
Viewing the Voice Details for Mesh Networks (CLI)	183
Enabling Mesh Multicast Containment for Video	186
Enabling Multicast on the Mesh Network (CLI)	187
IGMP Snooping	187
Locally Significant Certificates for Mesh APs	188
Guidelines for Configuration	188
Differences Between LSCs for Mesh APs and Normal APs	189
Certificate Verification Process in LSC AP	189
Getting Certificates for LSC Feature	189
Configuring a Locally Significant Certificate (CLI)	191
LSC-Related Commands	193
Controller GUI Security Settings	194
Deployment Guidelines	195

**CHAPTER 6****Checking the Health of the Network 197**

Show Mesh Commands	197
--------------------	-----

Viewing General Mesh Network Details	197
Viewing Mesh Access Point Details	199
Viewing Global Mesh Parameter Settings	200
Viewing Bridge Group Settings	200
Viewing VLAN Tagging Settings	201
Viewing DFS Details	201
Viewing Public Safety Setting	201
Viewing Security Settings and Statistics	202
Viewing GPS Status	202
Viewing Mesh Statistics for a Mesh Access Point	202
Viewing Mesh Statistics for a Mesh Access Point (GUI)	203
Viewing Mesh Statistics for an Mesh Access Point (CLI)	206
Viewing Neighbor Statistics for a Mesh Access Point	207
Viewing Neighbor Statistics for a Mesh Access Point (GUI)	207
Viewing the Neighbor Statistics for a Mesh Access Point (CLI)	208

---

**CHAPTER 7**
**Troubleshooting 211**

Installation and Connections	211
Debug Commands	212
Remote Debug Commands	213
AP Console Access	213
Cable Modem Serial Port Access From an AP	214
Configuration	214
Mesh Access Point CLI Commands	216
Mesh Access Point Debug Commands	218
Defining Mesh Access Point Roles	218
Backhaul Algorithm	219
Passive Beaconing (Anti-Stranding)	220
Dynamic Frequency Selection	221
DFS in RAP	221
DFS in MAP	222
Preparation in a DFS Environment	223
Monitoring DFS	224
Frequency Planning	224
Good Signal-to-Noise Ratios	225

Access Point Placement	225
Check Packet Error Rate	225
Bridge Group Name Misconfiguration	225
Misconfiguration of the Mesh Access Point IP Address	227
Misconfiguration of DHCP	228
Identifying the Node Exclusion Algorithm	228
Throughput Analysis	230

**CHAPTER 8****Managing Mesh Access Points with Cisco Prime Infrastructure 233**

Adding Campus Maps, Outdoor Areas, and Buildings with Cisco Prime Infrastructure	233
Adding Campus Maps	234
Adding Outdoor Areas	234
Adding a Building to a Campus Map	235
Adding Mesh Access Points to Maps with Cisco Prime Infrastructure	236
Monitoring Mesh Access Points Using Google Earth	237
Launching Google Earth in Cisco Prime Infrastructure	237
Viewing Google Earth Maps	238
Adding Indoor Mesh Access Points to Cisco Prime Infrastructure	241
Managing Mesh Access Points with Cisco Prime Infrastructure	242
Monitoring Mesh Networks Using Maps	242
Monitoring Mesh Link Statistics Using Maps	242
Monitoring Mesh Access Points Using Maps	243
Monitoring Mesh Access Point Neighbors Using Maps	244
Monitoring Mesh Health	245
Viewing Mesh Statistics for a Mesh Access Point	247
Viewing the Mesh Network Hierarchy	252
Using Mesh Filters to Modify Map Display of Maps and Mesh Links	253
Monitoring Workgroup Bridges	255
Multiple VLAN and QoS Support for WGB Wired Clients	256
Workgroup Bridge Guidelines	257
Configuring VLAN and QoS Support (CLI)	258
Workgroup Bridge Output	258
WGB Detail on Controller	260
Troubleshooting Tips	261
Viewing AP Last Reboot Reason	262



# Preface

---

This document provides design and deployment guidelines for the deployment of secure enterprise, campus, and metropolitan Wi-Fi networks within the Cisco wireless mesh networking solution, a component of the Cisco Unified Wireless Network (CUWN).

Mesh networking employs Cisco Aironet 1500 Series outdoor mesh access points and indoor mesh access points (Cisco Aironet 1040, 1130, 1140, 1240, 1250, 1260, 1600, 2600, 3500e, 3500i, 3600e, and 3600i, series access points) along with the Cisco Wireless LAN Controller, and Cisco Prime Infrastructure to provide scalable, central management, and mobility between indoor and outdoor deployments. Control and Provisioning of Wireless Access Points (CAPWAP) protocol manages the connection of mesh access points to the network.

End-to-end security within the mesh network is supported by employing Advanced Encryption Standard (AES) encryption between the wireless mesh access points and Wi-Fi Protected Access 2 (WPA2) clients. This document also outlines radio frequency (RF) components to consider when designing an outdoor network.

The features described in this document are for the following products:

- Cisco Aironet 1550 (1552) series outdoor mesh access points
- Cisco Aironet 1520 (1522, 1524) series outdoor mesh access points
- Cisco Aironet 1040, 1130, 1140, 1240, 1250, 1260, 1600, 2600, 3500e, 3500i, 3600e, and 3600i, series indoor mesh access points
- Mesh features in Cisco Wireless LAN Controller
- Mesh features in Cisco Prime Infrastructure

This chapter contains the following sections:

- [Audience, page xii](#)
- [Organization, page xii](#)
- [Conventions, page xii](#)
- [Related Documentation, page xv](#)
- [Obtaining Documentation and Submitting a Service Request, page xv](#)

# Audience

This document is for experienced network administrators who design and deploy mesh networks and configure and maintain Cisco mesh access points and Cisco wireless LAN controllers.

# Organization

This guide is organized into these chapters:

Chapter Title	Description
<a href="#">Mesh Network Components, on page 1</a>	This chapter describes the components of a mesh network.
<a href="#">Mesh Deployment Modes, on page 49</a>	This chapter describes the various deployment modes of mesh access points.
<a href="#">Design Considerations, on page 55</a>	This chapter describes the design considerations involved in a mesh network.
<a href="#">Site Preparation and Planning, on page 65</a>	This chapter describes the implementation details and configuration examples.
<a href="#">Connecting the Cisco 1500 Series Mesh Access Points to the Network, on page 103</a>	This chapter describes the procedures involved in connecting mesh access points to a network and configuring the mesh access points.
<a href="#">Checking the Health of the Network, on page 197</a>	This chapter describes the commands to enter to check the health of a mesh network.
<a href="#">Troubleshooting, on page 211</a>	This chapter describes the troubleshooting information.
<a href="#">Managing Mesh Access Points with Cisco Prime Infrastructure, on page 242</a>	This chapter describes information about managing access points with Cisco Prime Infrastructure.

# Conventions

This document uses the following conventions:

**Table 1: Conventions**

Convention	Indication
<b>bold font</b>	Commands and keywords and user-entered text appear in <b>bold font</b> .
<i>italic font</i>	Document titles, new or emphasized terms, and arguments for which you supply values are in <i>italic font</i> .
[ ]	Elements in square brackets are optional.



Convention	Indication
{x   y   z }	Required alternative keywords are grouped in braces and separated by vertical bars.
[ x   y   z ]	Optional alternative keywords are grouped in brackets and separated by vertical bars.
string	A nonquoted set of characters. Do not use quotation marks around the string or the string will include the quotation marks.
<code>courier font</code>	Terminal sessions and information the system displays appear in <code>courier font</code> .
<>	Nonprinting characters such as passwords are in angle brackets.
[]	Default responses to system prompts are in square brackets.
!, #	An exclamation point (!) or a pound sign (#) at the beginning of a line of code indicates a comment line.

**Note**

Means reader take note.

**Tip**

Means the following information will help you solve a problem.

**Caution**

Means reader be careful. In this situation, you might perform an action that could result in equipment damage or loss of data.

**Warning**

This warning symbol means danger. You are in a situation that could cause bodily injury. Before you work on any equipment, be aware of the hazards involved with electrical circuitry and be familiar with standard practices for preventing accidents. (To see translations of the warnings that appear in this publication, refer to the appendix "Translated Safety Warnings.")

Warning Title	Description
Waarschuwing	Dit waarschuwingssymbool betekent gevaar. U verkeert in een situatie die lichamelijk letsel kan veroorzaken. Voordat u aan enige apparatuur gaat werken, dient u zich bewust te zijn van de bij elektrische schakelingen betrokken risico's en dient u op de hoogte te zijn van standaard maatregelen om ongelukken te voorkomen. (Voor vertalingen van de waarschuwingen die in deze publicatie verschijnen, kunt u het aanhangsel "Translated Safety Warnings" (Vertalingen van veiligheidsvoorschriften) raadplegen.)

Warning Title	Description
Varoitus	Tämä varoitusmerkki merkitsee vaaraa. Olet tilanteessa, joka voi johtaa ruumiinvammaan. Ennen kuin työskentelet minkään laitteiston parissa, ota selvää sähkökytkentöihin liittyvistä vaaroista ja tavanomaisista onnettomuuksien ehkäisykeinoista. (Tässä julkaisussa esiintyvien varoitusten käännökset löydät liitteestä "Translated Safety Warnings" (käännetyt turvallisuutta koskevat varoitukset).)
Attention	Ce symbole d'avertissement indique un danger. Vous vous trouvez dans une situation pouvant entraîner des blessures. Avant d'accéder à cet équipement, soyez conscient des dangers posés par les circuits électriques et familiarisez-vous avec les procédures courantes de prévention des accidents. Pour obtenir les traductions des mises en garde figurant dans cette publication, veuillez consulter l'annexe intitulée « Translated Safety Warnings » (Traduction des avis de sécurité).
Warnung	Dieses Warnsymbol bedeutet Gefahr. Sie befinden sich in einer Situation, die zu einer Körperverletzung führen könnte. Bevor Sie mit der Arbeit an irgendeinem Gerät beginnen, seien Sie sich der mit elektrischen Stromkreisen verbundenen Gefahren und der Standardpraktiken zur Vermeidung von Unfällen bewußt. (Übersetzungen der in dieser Veröffentlichung enthaltenen Warnhinweise finden Sie im Anhang mit dem Titel "Translated Safety Warnings" (Übersetzung der Warnhinweise).)
Avvertenza	Questo simbolo di avvertenza indica un pericolo. Si è in una situazione che può causare infortuni. Prima di lavorare su qualsiasi apparecchiatura, occorre conoscere i pericoli relativi ai circuiti elettrici ed essere al corrente delle pratiche standard per la prevenzione di incidenti. La traduzione delle avvertenze riportate in questa pubblicazione si trova nell'appendice, "Translated Safety Warnings" (Traduzione delle avvertenze di sicurezza).
Advarsel	Dette varselsymbolet betyr fare. Du befinner deg i en situasjon som kan føre til personskade. Før du utfører arbeid på utstyr, må du være oppmerksom på de faremomentene som elektriske kretser innebærer, samt gjøre deg kjent med vanlig praksis når det gjelder å unngå ulykker. (Hvis du vil se oversettelser av de advarslene som finnes i denne publikasjonen, kan du se i vedlegget "Translated Safety Warnings" [Oversatte sikkerhetsadvarsler].)
Aviso	Este símbolo de aviso indica perigo. Encontra-se numa situação que lhe poderá causar danos físicos. Antes de começar a trabalhar com qualquer equipamento, familiarize-se com os perigos relacionados com circuitos eléctricos, e com quaisquer práticas comuns que possam prevenir possíveis acidentes. (Para ver as traduções dos avisos que constam desta publicação, consulte o apêndice "Translated Safety Warnings" - "Traduções dos Avisos de Segurança").
¡Advertencia!	Este símbolo de aviso significa peligro. Existe riesgo para su integridad física. Antes de manipular cualquier equipo, considerar los riesgos que entraña la corriente eléctrica y familiarizarse con los procedimientos estándar de prevención de accidentes. (Para ver traducciones de las advertencias que aparecen en esta publicación, consultar el apéndice titulado "Translated Safety Warnings.")

Warning Title	Description
Varning	Denna varningssymbol signalerar fara. Du befinner dig i en situation som kan leda till personskada. Innan du utför arbete på någon utrustning måste du vara medveten om farorna med elkretsar och känna till vanligt förfarande för att förebygga skador. (Se förklaringar av de varningar som förekommer i denna publikation i appendix "Translated Safety Warnings" [Översatta säkerhetsvarningar].)

## Related Documentation

These documents provide complete information about the Cisco Unified Wireless Network solution:

- *Cisco Wireless LAN Controller Configuration Guide*
- *Cisco Wireless LAN Controller Command Reference*
- *Cisco Prime Infrastructure Configuration Guide*
- *Release Notes for Cisco Wireless LAN Controllers and Lightweight Access Points*

## Obtaining Documentation and Submitting a Service Request

For information on obtaining documentation, submitting a service request, and gathering additional information, see the monthly *What's New in Cisco Product Documentation*, which also lists all new and revised Cisco technical documentation, at:

<http://www.cisco.com/en/US/docs/general/whatsnew/whatsnew.html>

Subscribe to the *What's New in Cisco Product Documentation* as a Really Simple Syndication (RSS) feed and set content to be delivered directly to your desktop using a reader application. The RSS feeds are a free service and Cisco currently supports RSS version 2.0.





# Mesh Network Components

This chapter describes the mesh network components.

The Cisco wireless mesh network has four core components:

- Cisco Aironet 1500 series mesh access points



---

**Note** Cisco Aironet 1505 and 1510 mesh access points are not supported because of their End-of-Life status.

---

- Cisco Wireless LAN Controller (hereafter referred to as **controller**)
- Cisco Prime Infrastructure
- Mesh software architecture

This chapter contains the following sections:

- [Mesh Access Points, page 1](#)
- [Cisco Wireless LAN Controllers, page 41](#)
- [Cisco Prime Infrastructure, page 41](#)
- [Architecture, page 41](#)

## Mesh Access Points

### Licensing for Mesh Access Points on a 5500 Series Controller

To use both mesh and nonmesh access points with a Cisco 5500 Series Controller, only the base license (LIC-CT5508-X) is required from the 7.0 release and later releases. For more information about obtaining and installing licenses, see the *Cisco Wireless LAN Controller Configuration Guide* at [http://www.cisco.com/en/US/products/ps10315/products\\_installation\\_and\\_configuration\\_guides\\_list.html](http://www.cisco.com/en/US/products/ps10315/products_installation_and_configuration_guides_list.html).

## Access Point Roles

Access points within a mesh network operate in one of the following two ways:

- 1 Root access point (RAP)
- 2 Mesh access point (MAP)

**Note**

---

All access points are configured and shipped as mesh access points. To use an access point as a root access point, you must reconfigure the mesh access point to a root access point. In all mesh networks, ensure that there is at least one root access point.

---

While the RAPs have wired connections to their controller, the MAPs have wireless connections to their controller.

MAPs communicate among themselves and back to the RAP using wireless connections over the 802.11a/n radio backhaul. MAPs use the Cisco Adaptive Wireless Path Protocol (AWPP) to determine the best path through the other mesh access points to the controller.

Bridge mode access points support CleanAir in mesh backhaul at 5GHz frequency and provides only the interference device report (IDR) and Air Quality Index (AQI) reports.

**Note**

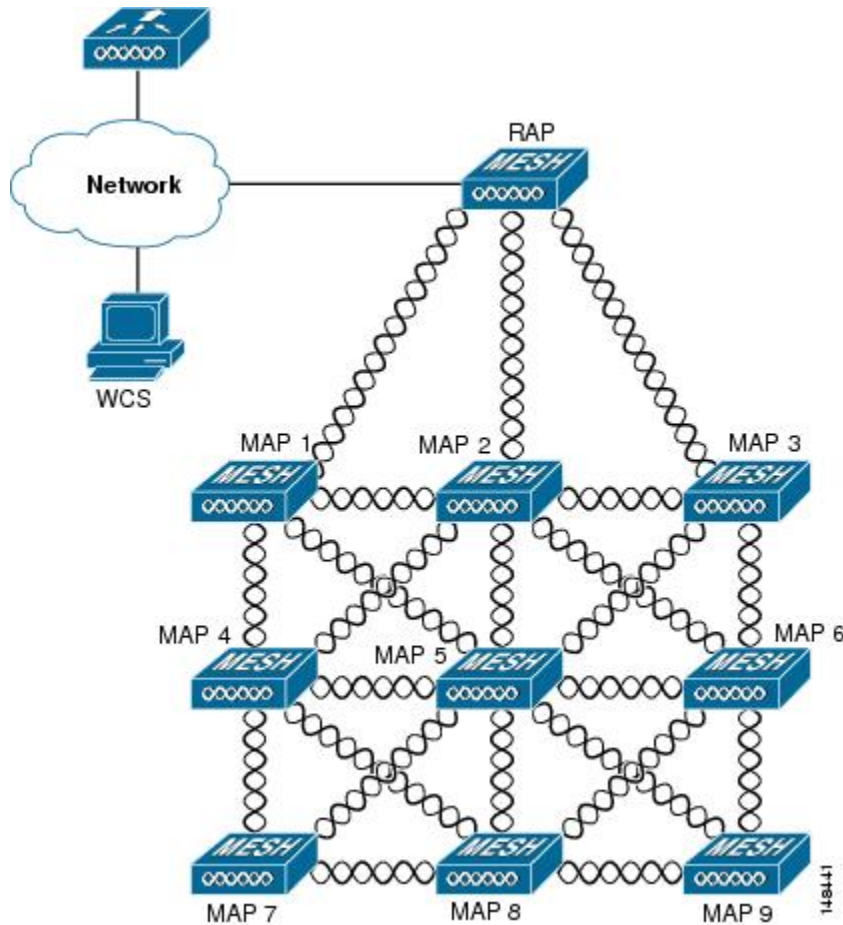
---

The RAP or MAP does not generate Bridge Protocol Data Unit (BPDU) itself. However, the RAP or MAP forwards the BPDU to upstream devices if the RAP or MAP received the BPDU from its connected wired or wireless interface across the network.

---

This figure shows the relationship between RAPs and MAPs in a mesh network.

**Figure 1: Simple Mesh Network Hierarchy**



## Network Access

Wireless mesh networks can simultaneously carry two different traffic types. They are as follows:

- Wireless LAN client traffic
- MAP Ethernet port traffic

Wireless LAN client traffic terminates on the controller, and the Ethernet traffic terminates on the Ethernet ports of the mesh access points.

Access to the wireless LAN mesh for mesh access points is managed by the following authentication methods:

- MAC authentication—Mesh access points are added to a database that can be referenced to ensure they are provided access to a given controller and mesh network.
- External RADIUS Authentication—Mesh access points can be externally authorized using a RADIUS server such as Cisco ACS (4.1 and later) that supports the client authentication type of Extensible Authentication Protocol-FAST (EAP-FAST) with certificates.

## Network Segmentation

Membership to the wireless LAN mesh network for mesh access points is controlled by the bridge group names (BGNs). Mesh access points can be placed in similar bridge groups to manage membership or provide network segmentation.

## Cisco Indoor Mesh Access Points

Indoor mesh is available on the following access points:

- 802.11a/b/g
  - 1130
  - 1240
- 802.11n
  - 1040
  - 1140
  - 1250
  - 1260
  - 1600
- 802.11n+CleanAir
  - 2600
  - 3500e
  - 3500i
  - 3600
- 802.11ac+CleanAir

**Note**

For more information about controller software support for access points, see the *Cisco Wireless Solutions Software Compatibility Matrix* at [http://www.cisco.com/en/US/docs/wireless/controller/5500/tech\\_notes/Wireless\\_Software\\_Compatibility\\_Matrix.html](http://www.cisco.com/en/US/docs/wireless/controller/5500/tech_notes/Wireless_Software_Compatibility_Matrix.html).

Enterprise 11n mesh is an enhancement added to the CUWN feature to work with the 802.11n access points. Enterprise 11n mesh features are compatible with non-802.11n mesh but adds higher backhaul and client access speeds. The 802.11n indoor access points are two-radio Wi-Fi infrastructure devices for select indoor deployments. One radio can be used for local (client) access for the access point and the other radio can be configured for wireless backhaul. The backhaul is supported only on the 5-GHz radio. Enterprise 11n mesh supports P2P, P2MP, and mesh types of architectures.



You have a choice of ordering indoor access points directly into the bridge mode, so that these access points can be used directly as mesh access points. If you have these access points in a local mode (nonmesh), then you have to connect these access points to the controller and change the AP mode to the bridge mode (mesh). This scenario can become cumbersome particularly if the volume of the access points being deployed is large and if the access points are already deployed in the local mode for a traditional nonmesh wireless coverage.

The Cisco indoor mesh access points are equipped with the following two simultaneously operating radios:

- 2.4-GHz radio used for client access
- 5-GHz radio used for data backhaul

The 5-GHz radio supports the 5.15 GHz, 5.25 GHz, 5.47 GHz, and 5.8 GHz bands.

## Cisco Outdoor Mesh Access Points

Cisco outdoor mesh access points comprise of the Cisco Aironet 1500 series access points. The 1500 series includes 1552 11n outdoor mesh access points, 1522 dual-radio mesh access points, and 1524 multi-radio mesh access points. There are two models of the 1524, which are the following:

- The public safety model, 1524PS
- The serial backhaul model, 1524SB



---

**Note**

In the 6.0 release, the AP1524SB access point was launched in A, C, and N domains. In the 7.0 release, the AP1524SB access point was launched in the -E, -M, -K, -S, and -T domains.

---

Cisco 1500 series mesh access points are the core components of the wireless mesh deployment. AP1500s are configured by both the controller (GUI and CLI) and Cisco Prime Infrastructure. Communication between outdoor mesh access points (MAPs and RAPs) is over the 802.11a/n radio backhaul. Client traffic is generally transmitted over the 802.11b/g/n radio (802.11a/n can also be configured to accept client traffic), and public safety traffic (AP1524PS only) is transmitted over the 4.9-GHz radio.

The mesh access point can also operate as a relay node for other access points not directly connected to a wired network. Intelligent wireless routing is provided by the Adaptive Wireless Path Protocol (AWPP). This Cisco protocol enables each mesh access point to identify its neighbors and intelligently choose the optimal path to the wired network by calculating the cost of each path in terms of the signal strength and the number of hops required to get to a controller.

AP1500s are manufactured in two different configurations: cable and noncable.

- The cable configuration can be mounted to a cable strand and supports power-over-cable (POC).
- The noncable configuration supports multiple antennas. It can be mounted to a pole or building wall and supports several power options.

Uplinks support includes Gigabit Ethernet (1000BASE-T) and a small form-factor (SFP) slot that can be plugged for a fiber or cable modem interface. Both single mode and multimode SFPs up to 1000BASE-BX are supported. The cable modem can be DOCSIS 2.0 or DOCSIS/EuroDOCSIS 3.0 depending upon the type of mesh access point.

AP1500s are available in a hazardous location hardware enclosure. When configured, the AP1500 complies with safety standards for Class I, Division 2, Zone 2 hazardous locations.



**Note** See the *Cisco Aironet 1520 Series Lightweight Outdoor Access Point Ordering Guide* for power, mounting, antenna, and regulatory support by model: [http://www.cisco.com/en/US/prod/collateral/wireless/ps5679/ps8368/product\\_data\\_sheet0900aecd8066a157.html](http://www.cisco.com/en/US/prod/collateral/wireless/ps5679/ps8368/product_data_sheet0900aecd8066a157.html)

The mesh access points, can operate, apart from the mesh mode, in the following modes:

- **Local mode**—In this mode, the AP can handle clients on its assigned channel or while monitoring all channels on the band over a 180-second period. During this time, the AP listens on each channel for 50 milliseconds for rogue client beacons, noise floor measurements, interference, and IDS events. The AP also scans for CleanAir interference on the channel.
- **FlexConnect mode**—FlexConnect is a wireless solution for branch office and remote office deployments. The FlexConnect mode enables you to configure and control access points in a branch or remote office from the corporate office through a WAN link without having to deploy a controller in each office. The FlexConnect mode can switch client data traffic locally and perform client authentication locally when the connection to the controller is lost. When connected to the controller, the FlexConnect mode can also tunnel traffic back to the controller.
- **Monitor mode**—In this mode, the AP radios are in the receive state. The AP scans all the channels every 12 seconds for rogue client beacons, noise floor measurements, interference, IDS events, and CleanAir intruders.
- **Rogue Detector mode**—In this mode, the AP radio is turned off, and the AP listens only to the wired traffic. The controller passes the APs that are configured as rogue detectors as well as lists of suspected rogue clients and AP MAC addresses. The rogue detector listens for ARP packets and can be connected to all broadcast domains through a trunk link.
- **Sniffer mode**—In this mode, the AP captures and forwards all packets on a channel to a remote device that decodes the packets with packet analyzer software such as Wireshark.
- **Bridge mode**—In this mode, the AP is configured to build a wireless mesh network where wired network cabling is not available.



**Note** You can configure these modes using both the GUI and CLI. For configuration instructions, see the *Cisco Wireless LAN Controller Configuration Guide*.



**Note** MAPs can only be configured in Bridge mode regardless of their wired or wireless backhaul. If the MAPs have a wired backhaul, you must change their AP role to RAP before you change the AP Mode.

## Cisco Aironet 1552 Mesh Access Point

The Cisco Aironet 1550 Series Outdoor Mesh Access Point is a modularized wireless outdoor 802.11n access point designed for use in a mesh network. The access point supports point-to-multipoint mesh wireless connectivity and wireless client access simultaneously. The access point can also operate as a relay node for

other access points that are not directly connected to a wired network. Intelligent wireless routing is provided by the Adaptive Wireless Path Protocol (AWPP). This enables the access point to identify its neighbors and intelligently choose the optimal path to the wired network by calculating the cost of each path in terms of signal strength and the number of hops required to get to a controller.

The 1550 series access points leverage 802.11n technology with integrated radio and internal/external antennas. The 1552 outdoor platform consists of Multiple Input Multiple Output (MIMO) WLAN radios. It offers 2x3 MIMO with two spatial streams, Beamforming, and comes with integrated spectrum intelligence (CleanAir).

CleanAir provides full 11n data rates while detecting, locating, classifying, and mitigating radio frequency (RF) interference to provide the best client experience possible. CleanAir technology on the outdoor 11n platform mitigates Wi-Fi and non-Wi-Fi interference on 2.4-GHz radios.

The 1550 series access points have two radios—2.4-GHz and 5-GHz MIMO radios. While the 2.4-GHz radios are used primarily for local access, the 5-GHz radios are used for both local access and wireless backhaul in mesh mode.

**Note**

The wIPS submode is not supported on the Cisco 1552 Series Mesh Access Points.

**Note**

The 2.4-GHz radios cannot be used for backhaul in 1552 APs.

The 2-GHz b/g/n radio has the following features:

- Operates in the 2.4-GHz ISM band.
- Supports channels 1-11 in the United States, 1-13 in Europe, and 1-13 in Japan.
- Has two transmitters for 802.11b/g/n operation.
- You can configure the output power for 5 power levels.
- The radio has three receivers that enable maximum-ratio combining (MRC).

The 5-GHz a/n radio has the following feature:

- Operates in the UNII-2 band (5.25 to 5.35 GHz), UNII-2 Extended/ETSI band (5.47 to 5.725 GHz), and the upper ISM band (5.725 to 5.850 GHz).
- Has two transmitters for 802.11a operation.
- Power settings can change depending on the regulatory domain. You can configure the output power for 5 power levels in 3 dB steps.
- The radio has three receivers that enable maximum-ratio combining (MRC).

The 1550 series access points have the following features:

- Supports modularity of the 1520 series and allows flexibility in radio configuration
- Fully interoperable with the 1520 series access points
- Can also interoperate with legacy clients and offers enhanced backhaul performance
- Multicast VideoStream and HotSpot 2.0 are supported when the AP is configured in Local mode.
- AP1552 is QoS capable of supporting quality VoWLAN calls.

- Band Select, which notifies a connected client to roam from 2.4 GHz to 5 GHz, is supported.
- DTLS support allows AP1552 to encrypt data in all supported AP modes except Bridge mode.
- You can enable CleanAir on the 5-GHz radio by navigating to **Wireless > Radios > 802.11a > Configure** on the controller GUI.
- If AP1552 is in Bridge mode, CleanAir Advisor becomes operational. CleanAir Advisor generates CleanAir reports and identifies interference. The event driven RRM is disabled. Therefore, the radio does not change the transmission power level or channel.

The models can be classified as models with external antennas and models with built-in antennas. The 1552C model is configured with an integrated DOCSIS/EuroDOCSIS 3.0 cable modem. The DOCSIS 3.0 cable modem provides 8 DS and 4 US (8x4), 304x108 Mbps. The EuroDOCSIS 3.0 cable modem provides 4 US and 4 DS (4x4), 152x108 Mbps. While a DOCSIS 2.0 cable modem could provide throughput of up to 40 Mbps only, a DOCSIS 3.0 cable modem can provide a DS throughput of 290 Mbps and a US throughput of 100 Mbps.

The 1552 Access Point is available in these models:

- [1552E, on page 8](#)
- [1552C, on page 9](#)
- [1552I, on page 10](#)
- [1552H, on page 10](#)
- [1552CU, on page 11](#)
- [1552EU, on page 11](#)

For more information about the Cisco 1550 Series Access Points, see <http://www.cisco.com/en/US/products/ps11451/index.html>.

## 1552E

The Cisco Aironet 1552E Outdoor Access Point is the standard model, dual-radio system with dual-band radios that are compliant with IEEE 802.11a/n (5-GHz) and 802.11b/g/n standards (2.4 GHz). The 1552E has three external antenna connections for three dual-band antennas. It has Ethernet and fiber Small Form Factor Pluggable (SFP) backhaul options, along with the option of a battery backup. This model also has a PoE-out port and can power a video surveillance camera. A highly flexible model, the Cisco Aironet 1552E is well equipped for municipal and campus deployments, video surveillance applications, mining environments, and data offload.

The 1552E model has the following features:

- Weighs 17.3 lbs (7.9 kg) excluding external antennas
- Two radios (2.4 GHz and 5 GHz)
- Three external dual-band omnidirectional antennas with 4 dBi in 2.4 GHz and 7 dBi in 5 GHz
- Vertical beamwidth: 29° at 2.4 GHz, 15° at 5 GHz
- Aligned console port
- Higher equivalent isotropically radiated power (EIRP)
- Multiple uplinks with Ethernet and fiber

- An optional Small Form Factor Pluggable (SFP) fiber module that can be ordered with the AP. The AP can use SFP fiber or copper module.
- 802.3af-compliant PoE-Out option to connect IP devices (such as video cameras)
- AC Powered (100 to 480 VAC)
- PoE-In using Power Injector
- Battery backup option (6 AH)



---

**Note** The 1552E model has no cable modem. The 1552E battery cannot be used for 1552H.

---

- AP1552E can be ordered with an Ethernet Passive Optical Network SFP as an add-on. The EPON SFP provides Gigabit data rates.



---

**Note** The EPON SFP feature must be ordered separately and installed.

---

- The AP1552 can be ordered with a GPS module as an add-on. The GPS module provides GPS coordinates every 5 minutes and automatically updates location in the Cisco Prime Infrastructure Street Maps.



---

**Note** The AP1552E with a GPS Module must be powered using AC or DC power. The GPS module will be disabled if the AP is powered by PoE or battery backup.

---

## 1552C

Where service providers have already invested in a broadband cable network, the Cisco next-generation outdoor wireless mesh can seamlessly extend network connectivity with the Cisco Aironet 1552C access point by connecting to its integrated cable modem interface. The Cisco Aironet 1552C Outdoor Mesh Access Point is a dual-radio system with DOCSIS 3.0/EuroDOCSIS 3.0 (8x4 HFC) cable modem for power and backhaul. It has dual-band radios that are compliant with IEEE 802.11a/n (5 GHz) and 802.11b/g/n standards (2.4 GHz). The 1552C has an integrated, three-element, dual-band antenna and easily fits within the 30 cm height restriction for service providers. This model is suitable for 3G data offload applications and public Wi-Fi.

The 1552C model has the following features:

- Lightweight (14 lbs or 6.4 kg), low-profile AP
- Two radios (2.4 GHz and 5 GHz)
- DOCSIS/EuroDOCSIS 3.0 Cable Modem
- Aligned console port
- It supports cable modem backhaul
- Has an integrated 3-element array antenna with 2 dBi in 2.4 GHz and 4 dBi in 5 GHz
- Input module, power-over-cable supply (40 to 90 VAC)
- Stamped cover with two convenient holes to tighten the seizure screw for stringer connector (RF/Power Input) and to adjust the fuse pad to attenuate the signal



---

**Note** The 1552C model has no battery backup, no fiber SFP support, no PoE Out, no PoE In using Power Injector or Ethernet port, and no AC power option.

---

- The AP1552 can be ordered with a GPS module as an add-on. The GPS module provides GPS coordinates every 5 minutes and automatically updates location in the Cisco Prime Infrastructure Street Maps.

### 1552I

The Cisco Aironet 1552I Outdoor Access Point is a low-profile, lighter weight model. The smaller size and sleeker look helps it blend with the surrounding environment. The smaller power supply also makes it an energy efficient product. The 1552I does not have PoE-Out or a fiber SFP port.

The 1552I model has the following features:

- Lightweight (14 lbs or 6.4 kg), low-profile version
- Two radios (2.4 GHz and 5 GHz)
- Aligned console port
- AC powered (100 to 277 VAC)
- Stamped cover with no holes
- Supports street light power TAP



---

**Note** The 1552I model has no battery backup, no fiber SFP support, no cable modem, and no PoE Out.

---

### 1552H

This access point is designed for hazardous environments like oil and gas refineries, chemical plants, mining pits, and manufacturing factories. The Cisco Aironet 1552H Outdoor Access Point is Class 1, Div 2/Zone 2 hazardous location certified. The features are similar to the 1552E model, with the exception of the battery backup.

The 1552H model has the following features:

- Weighs 14 lbs (6.4 kg)
- Two radios (2.4 GHz and 5 GHz)
- Hazardous Location (Haz Loc) version.
- Power-over-Ethernet (PoE) input using Power Injector
- Aligned console port
- Three dual-band external omnidirectional antennas
- AC entry module with terminal block
- AC powered (100 to 240 VAC, as per ATEX certification requirement)

- Fiber SFP backhaul option
- 802.3af-compliant PoE Out option to connect IP devices (such as video cameras)
- Battery backup option (special battery for hazardous locations)

For more information about Cisco Aironet 1552 mesh access point hardware and installation instructions, see [http://www.cisco.com/en/US/products/ps11451/prod\\_installation\\_guides\\_list.html](http://www.cisco.com/en/US/products/ps11451/prod_installation_guides_list.html)

### 1552CU

The 1552CU model has the following features:

- Two radios (2.4 GHz and 5 GHz)
- Aligned console port
- AC powered (40 to 90 VAC)
- Stamped cover with no holes
- External high-gain antennas (13 dBi in 2.4 GHz, 14 dBi in 5 GHz)
- Cable modem
- The AP1552 can be ordered with a GPS module as an add-on. The GPS module provides GPS coordinates every 5 minutes and automatically updates location in the Cisco Prime Infrastructure Street Maps.

### 1552EU

The 1552EU model has the following features:

- Two radios (2.4 GHz and 5 GHz)
- Aligned console port
- AC powered (90 to 480 VAC)
- PoE 802.3af
- External high-gain antennas (13 dBi in 2.4 GHz, 14 dBi in 5 GHz)
- Battery
- AP1552EU can be ordered with an Ethernet Passive Optical Network SFP as an add-on. The EPON SFP provides Gigabit data rates.



---

**Note** The EPON SFP feature must be ordered separately and installed.

---

- The AP1552 can be ordered with a GPS module as an add-on. The GPS module provides GPS coordinates every 5 minutes and automatically updates location in the Cisco Prime Infrastructure Street Maps.



---

**Note** The AP1552EU with a GPS Module must be powered using AC or DC power. The GPS module will be disabled if the AP is powered by PoE or battery backup.

---

## Cisco 1522 Mesh Access Point

The AP1522 mesh access point (part numbers: AIR-LAP1522AG-X-K9, AIR-LAP1522HZ-X-K9, AIR-LAP1522PC-X-K9) includes two radios: a 2.4-GHz and a 4.9- to 5.8-GHz radio. The 2.4-GHz (802.11b/g) radio is for client access and the 5-GHz (802.11a) radio is used as the backhaul. With the 7.0.116.0 release and later releases, 2.4 GHz is available for backhaul. This feature is applicable only to AP1522.

The 5-GHz radio is a 802.11a radio that covers the 4.9- to 5.8-GHz frequency band and is used as a backhaul. It can also be used for client access if the *backhaul client access* feature is enabled.




---

**Note** AP1522s with serial numbers *prior* to FTX1150XXXX do **not** support 5- and 10-MHz channels on the 4.9-GHz radio; however, a 20-MHz channel is supported.

---




---

**Note** Those AP1522s with serial numbers *after* FTX1150XXXX support 5-, 10-, and 20-MHz channels.

---

## Cisco 1524PS Mesh Access Point

The AP1524PS mesh access point (part number: AIR-LAP1524PS-X-K9) includes three radios: a 2.4-GHz, a 5.8-GHz, and a 4.9-GHz radio. The 2.4-GHz radio is for client access (nonpublic safety traffic) and the 4.9-GHz radio is for public safety client access traffic only. The 5.8-GHz radio can be used as the backhaul for both public safety and nonpublic safety traffic.

The 4.9-GHz and 5.8-GHz radios are 802.11a subband radios that support a subset of specific 802.11a channels and include a subband specific filter designed to lessen interference from other 11a subband radios within the same mesh access point.

The 4.9-GHz subband radio on the AP1524 supports public safety channels within the 5-MHz (channels 1 to 10), 10-MHz (channels 11 to 19), and 20-MHz (channels 20 to 26) bandwidths.

- The data rates supported within the 5-MHz bandwidth are 1.5, 2.25, 3, 4.5, 6, 9, 12, and 13.5 Mbps. The default rate is 6 Mbps.
- The data rates supported within the 10-MHz bandwidth are 3, 4.5, 6, 9, 12, 18, 24, and 27 Mbps. The default rate is 12 Mbps.

## Cisco 1524SB Mesh Access Point

The AP1524SB mesh access point (part number: AIR-LAP1524SB-X-K9) includes three radios: one 2.4-GHz radio and two 5-GHz radios.

The 2.4-GHz radio is for client access (nonpublic safety traffic). The two 5-GHz radios serve as serial backhauls: one uplink and one downlink. The AP1524SB is suitable for linear deployments.




---

**Note** In the 6.0 release, the 5-GHz radios in the -A domain could be operated only in the 5.8-GHz band with 5 channels. In the 7.0 release, these radios cover the whole 5-GHz band.

---



Each 5-GHz radio backhaul is configured with a different backhaul channel. There is no need to use the same shared wireless medium between the north-bound and south-bound traffic in a mesh tree-based network.

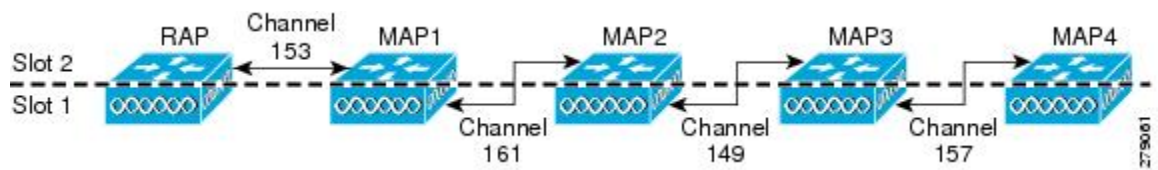
On the RAP, the radio in slot 2 is used to extend the backhaul in the downlink direction; the radio in slot 1 is used only for client access and not mesh.

On the MAP, the radio in slot 2 is used for the backhaul in the uplink direction; the radio in slot 1 is used for the backhaul in the downlink direction.

You only need to configure the RAP downlink (slot 2) channel. The MAPs automatically select their channels from the channel subset. The available channels for the 5.8-GHz band are 149, 153, 157, 161, and 165.

This figure shows an example of channel selection when the RAP downlink channel is 153.

**Figure 2: Channel Selection Example**



### Fall Back Mode

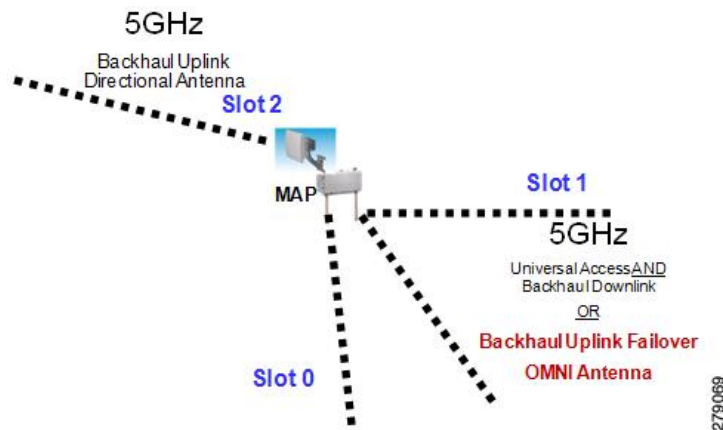
Slot 1 in a 5-GHz radio in a MAP can act as an uplink radio for the backhaul in any one of the following scenarios:

- Slot 2 radio fails.
- Antenna for slot 2 radio goes bad.
- Slot 2 radio is unable to find the uplink because of a bad RF design.
- Interference and long-term fades disturb the uplink to the extent that the slot 2 radio loses its uplink connection.

When a slot 1 radio takes over a slot 2 radio, it is called Fall Back Mode. The slot 2 radio is made inactive on a noninterfering channel. The hardware is reduced to AP1522 (two radios). The slot 1 radio (omni antenna) is extended to the uplink. A period of 15 minutes is set on a timer to attempt a rescan to find a parent on the slot 2 radio again. The timer is similar to the default BGN timer.

This figure shows an example of the Fall Back Mode.

**Figure 3: Fall Back Mode**



The antenna ports are labeled on the AP1524SB and are connected internally to the radios in each slot. The AP1524SB has six ports with three radio slots (0, 1, 2) as described in [Table 2: AP1524SB Antenna Ports](#), on page 14.

**Table 2: AP1524SB Antenna Ports**

Antenna Port	Radio Slot	Description
1	1	5 GHz—Used for backhaul and universal access. Universal access is configured only on slot 1. <b>Note</b> Omni antenna is required.
2	0	2 GHz—Used for client access.
3	0	2 GHz—Used for client access.
4	0	2 GHz—Used for client access.
5	—	Not connected.
6	2	5 GHz—Used for backhaul. <b>Note</b> Directional antenna is required.



**Note**

Depending on the product model, the AP1524SB could have either 5-GHz radios or 5.8-GHz subband radios installed in slot 1 and slot 2. Regardless of the radios installed, the AP1524SB running controller software release 6.0 is restricted to the UNII-3 channels (149, 153, 157, 161, and 165) in slot 1 and slot 2.

## Ethernet Ports

AP1500s support four Gigabit Ethernet interfaces.

- Port 0 (g0) is a Power over Ethernet (PoE) input port—PoE (in)
- Port 1 (g1) is a PoE output port—PoE (out)
- Port 2 (g2) is a cable connection
- Port 3 (g3) is a fiber connection

You can query the status of these four interfaces in the controller CLI and Cisco Prime Infrastructure.

In the controller CLI, the **show mesh env summary** command is used to display the status of the ports.

- The Up or Down (Dn) status of the four ports is reported in the following format:
  - port0(PoE-in):port1(PoE-out):port2(cable):port3(fiber)
- For example, *rap1522.a380* in the display below shows a port status of *UpDnDnDn*. This indicates the following:
  - PoE-in port 0 (g0) is Up, PoE-out port 1 (g1) is Down (Dn), Cable port 2 (g2) is Down (Dn), and Fiber port 3 (g3) is Down (Dn).

```
(controller)> show mesh env summary
AP Name      Temperature (C/F)  Heater  Ethernet  Battery
-----
rap1242.c9ef  N/A                N/A     UP         N/A
rap1522.a380  29/84              OFF     UpDnDnDn  N/A
rap1522.4da8  31/87              OFF     UpDnDnDn  N/A
```

## Multiple Power Options

### For the 1550 Series

Power options include the following:

- Power over Ethernet (PoE)-In
  - 56 VDC using a Power Injector (1552E and 1552H)
  - PoE-In is not 802.3af and does not work with PoE 802.3af-capable Ethernet switch
- AC Power
  - 100 to 480 VAC (47-63 Hz)—Connecting AC or Streetlight Power (1552E)
  - 100 to 240 VAC—Connecting AC or Streetlight Power (1552H)
- External Supply
  - 12 VDC—Connecting DC Power Cable (All Models)
- Internal Battery Backup (1552E and 1552H)

- Power over Cable (PoC)
  - 40 to 90VAC—Connecting Cable PoC (1552C)
- PoE-Out 802.3af compliant to connect IP devices such as Video Cameras (1552E and 1552H)
  - (PoE-Out) is not available when using Power Injector (PoE-In) as the power source
- 802.3af compliant PoE-Out to connect IP devices such as video cameras (1552E and 1552H)
 

This port also performs Auto-MDIX, which enables to connect crossover or straightthrough cables.

The 1550 series access points can be connected to more than one power source. The access points detect the available power sources and switch to the preferred power source using the following default prioritization:

- AC power or PoC power
- External 12-VDC power
- Power injector PoE power
- Internal battery power

[Table 3: Power Options in 1552 Models](#), on page 16 lists the power options available for the 1552 access point models.

**Table 3: Power Options in 1552 Models**

Power Option	1552E	1552H	1552C	1552I
<b>AC</b>	<b>100 to 480 VAC 80W</b>	<b>100 to 240 VAC 80W</b>	<b>Not Applicable</b>	<b>100 to 277 VAC 50W</b>
Power over Cable	Not Applicable	Not Applicable	40-90 V (quasi-square wave) 45W	Not Applicable
PoE (using Power Injector)	56V +/- 10%	56V +/- 10%	Not Applicable	Not Applicable
DC (nominal 12 VDC)	11.4 – 15V	11.4 – 15V	11.4 – 12.6V	11.4 – 15V
Battery Backup	80W-hr	35W-hr	Not Applicable	Not Applicable

#### For the 1520 Series

Power options include the following:

- 100 to 480 VAC streetlight power
- 12 VDC
- Power-over-cable power supply (40 to 90 VAC)

- PoE using a separate power injection system (48 VDC)
  - For more information about the power injection, its specifications, and installation, see [http://www.cisco.com/en/US/docs/wireless/access\\_point/1520/power/guide/1520pwrinj.html](http://www.cisco.com/en/US/docs/wireless/access_point/1520/power/guide/1520pwrinj.html)
- Internal battery backup power
- 802.3af-compliant PoE-Out to connect IP devices (such as video cameras)  
This port also performs Auto-MDIX, which allows to connect crossover or straightthrough cables.

## Battery Backup Module (Optional)

Battery backup six-ampere hour module is available for the following:

- AIR-1520-BATT-6AH for AP1520s
- AIR-1550-BATT-6AH for only the AIR-CAP-1552E-x-K9 model

The integrated battery can be used for temporary backup power during external power interruptions.

The battery run time for AP1520s is as follows:

- 3-hour access point operation with up to 3 radios at 77oF (25oC) with PoE output port off
- 2-hour access point operation with up to 3 radios at 77oF (25oC) with PoE output port on

The battery run time for AP1550s is as follows:

- 2-hour access point operation using two radios at 77oF (25oC) with PoE output port off
- 1.5-hour access point operation using two radios at 77oF (25oC) with PoE output port on

The battery pack is not supported on the access point cable configuration.



### Note

For a complete listing of optional hardware components for AP1520s such as mounting brackets, power injectors, and power tap adapters, see [http://www.cisco.com/en/US/prod/collateral/wireless/ps5679/ps8368/product\\_data\\_sheet0900aecd8066a157.html](http://www.cisco.com/en/US/prod/collateral/wireless/ps5679/ps8368/product_data_sheet0900aecd8066a157.html)

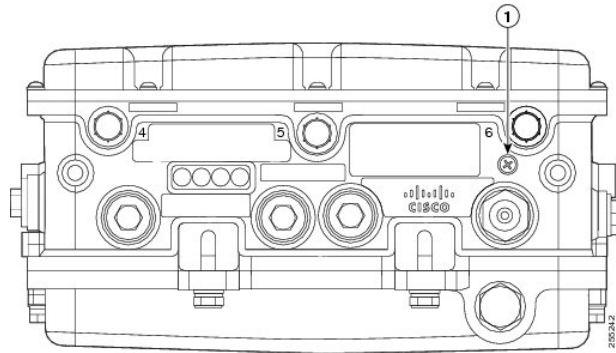
## Reset Button

A 1500 series access point has a reset button located on the bottom of the unit. The reset button is recessed in a small hole that is sealed with a screw and a rubber gasket. The reset button can be used to perform the following functions:

- Reset the access point—Press the reset button for less than 10 seconds, and the LEDs turn off during the reset and then reactivate when the reset is complete.
- Disable battery backup power—Press the reset button for more than 10 seconds, and the LEDs turn off, then on, and then stay off.
  - You can also disable the battery remotely by entering the following command:  
**config mesh battery-state disable *AP\_name***

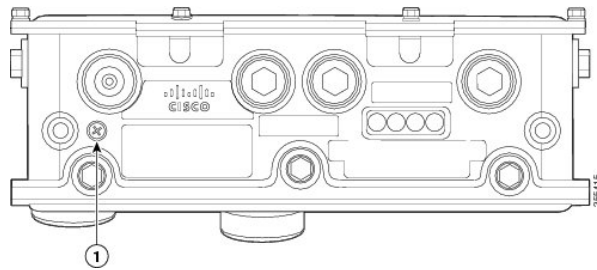
- Switch off LEDs—Press the reset button for more than 10 seconds, and the LEDs turn off, then on, and then stay off.

**Figure 4: Reset Button Location - Models AIR-CAP1552E-x-K9 and AIR-CAP1552H-x-K9**



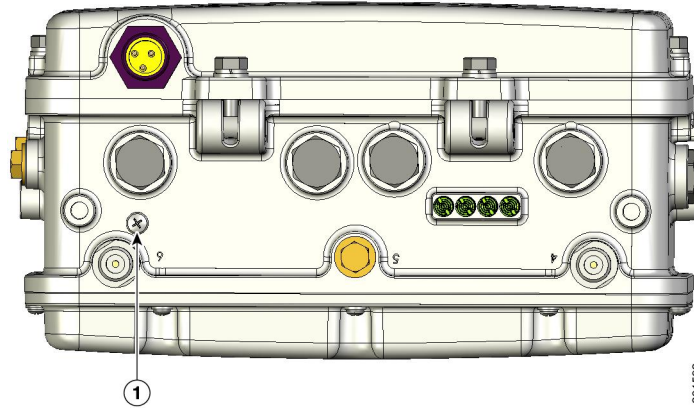
1	Reset button
---	--------------

**Figure 5: Reset Button Location - Models AIR-CAP1552C-x-K9 and AIR-CAP1552I-x-K9**



1	Reset button
---	--------------

Figure 6: Reset Button Location for 1520 Series



1	Reset button location
---	-----------------------

## Resetting Access Point

To reset the access point, follow these steps:

- Step 1** Use a Phillips screwdriver to remove the reset button screw. Ensure that you do not lose the screw.
- Step 2** Use a straightened paperclip, and push the reset button for less than 10 seconds. This step causes the access point to reboot (power cycle), all LEDs turn off for approximately 5 seconds, and then the LEDs reactivate.
- Step 3** Replace the reset button screw, and use a Phillips screwdriver to tighten to 22 to 24 in. lbs (2.49 to 2.71 nm).

## Monitoring the LED Status

The four-status LEDs on AP1500s are useful during the installation process to verify connectivity, radio status, access point status, and software status. However, once the access point is up and running and no further diagnosis is required, we recommend that you turn off the LEDs to discourage vandalism.

If your access point is not working as expected, see the LEDs at the bottom of the unit. You can use them to quickly assess the status of the unit.

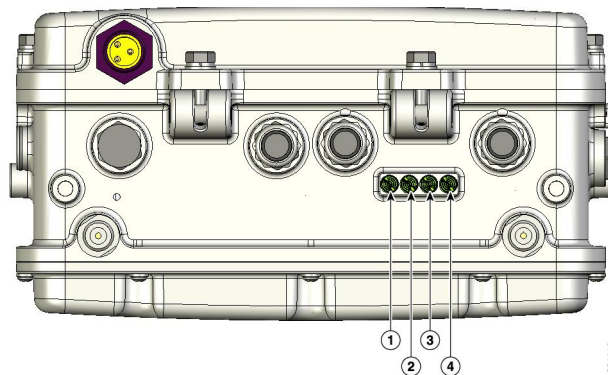


**Note** LEDs are enabled or disabled using the `config ap led-state {enable | disable} {cisco_ap_name | all}` command.

There are four LED status indicators on AP1500s.

This figure shows the location of the AP1500 LEDs.

**Figure 7: Access Point LEDs at the Bottom of the Unit**



The table below describes each LED and its status.

1	Status LED—Access point and software status	3	RF-1 LED—Status of the radio in slot 0 (2.4-GHz) and slot 2 (5.8-GHz for 1524SB and 4.9-GHz for 1524PS)).
2	Uplink LED—Ethernet, cable, or fiber status	4	RF-2 LED—Status of the radio in slot 1 (5.8-GHz) and the radio in slot 3. <sup>1</sup>

<sup>1</sup> Slot 3 is disabled



**Note**

The RF-1 and RF-2 LEDs monitor two radios simultaneously but do not identify the affected radio. For example, if the RF-1 LED displays a steady red LED, one or both of the radios in slots 0 and 2 have experienced a firmware failure. To identify the failing radio, you must use other means, such as the access point CLI or controller GUI to investigate and isolate the failure.

[Table 4: Access Point LED Signals](#), on page 21 lists the access point LED signals.



**Table 4: Access Point LED Signals**

LED	Color <sup>2 3</sup>	Meaning
Status	Off	Access is point is not powered on.
	Green	Access point is operational.
	Blinking green	Download or upgrade of Cisco IOS image file is in progress.
	Amber	Mesh neighbor access point discovery is in progress.
	Blinking amber	Mesh authentication is in progress.
	Blinking red/green/amber	CAPWAP discovery is in progress.
	Red	Firmware failure. Contact your support organization for assistance.
Uplink	Off	No physical connector is present. The uplink port is not operational.
	Green	Uplink network is operational (cable, fiber optic, or Ethernet).
RF-1 Slot 0 2.4-GHz radio	Off	Radio is turned off.
	Green	Radio is operational.
	Red	Firmware failure. Contact your support organization for assistance.
RF-1 Slot 2 802.11a radio	Off	Radio is turned off.
	Green	Radio is operational.
	Red	Firmware failure. Contact your support organization for assistance.
RF-2 Slot 1 802.11a radio	Off	Radio is turned off.
	Green	Radio is operational.
	Red	Firmware failure. Contact your support organization for assistance.
RF-2 Slot 3	Disabled in this release.	—

- 2 If all LEDs are off, the access point has no power.
- 3 When the access point power supply is initially turned on, all LEDs are amber.

## Serial Backhaul Access Point Guidelines for the Rest of the World (ROW)

In the 7.0 release, new 1524 SKUs are released, with both 802.11a radio units supporting the entire 5-GHz band from 4.9 GHz to 5.8 GHz. This release also opens the 5-GHz band for the -A domain as well on the existing hardware. The radios can also operate in UNII-2 (5.25 to 5.35 GHz), UNII-2 plus (5.47 to 5.725 GHz), and the upper ISM (5.725 to 5.850 GHz) bands.

The public safety band (4.94 to 4.99 GHz) is not supported for backhaul and for client access.

For information about the channels and maximum power levels of the AP1500 supported within the world's regulatory domains, see the *Channels and Maximum Power Settings for Cisco Aironet Lightweight Access Points* manual at:

- AP1520: [http://www.cisco.com/en/US/docs/wireless/access\\_point/channels/lwapp/reference/guide/1520\\_chp.html](http://www.cisco.com/en/US/docs/wireless/access_point/channels/lwapp/reference/guide/1520_chp.html)

**Table 5: Channels Supported Per Regulatory Domain**, on page 22 provides a complete overview of channels supported in each domain. In addition to 5 channels in the upper ISM band, there are 4 channels in the UNII-2 band and 11 channels in the UNII-2 Plus band. For outdoor APs, there are 5 channels in the upper ISM band, 3 channels in the UNII-2 band, and 8 channels in the UNII-2 Plus band.

**Table 5: Channels Supported Per Regulatory Domain**

Channel ID	Frequency (MHz)	Regulatory Domains								
		-A	-C	-E	-K	-M	-N	-P	-S	-T
4940-5100 MHz										
184	4920							Yes		
188	4949							Yes		
22/192	4960							Yes		
26/196	4980							Yes		
8	5040							Yes		
12	5060							Yes		
5250-5350 MHz										
52	5260									
56	5280	DFS			DFS					
60	5300	DFS			DFS					
64	5320	DFS			DFS					

Channel ID	Frequency (MHz)	Regulatory Domains								
		-A	-C	-E	-K	-M	-N	-P	-S	-T
5470-5725 MHz										
100	5500	DFS		DFS	DFS	DFS				DFS
104	5520	DFS		DFS	DFS	DFS				DFS
108	5540	DFS		DFS	DFS	DFS				DFS
112	5560	DFS		DFS	DFS	DFS				DFS
116	5580	DFS		DFS	DFS	DFS				DFS
120	5580				DFS					DFS
124	5620				DFS					DFS
128	5640									DFS
132	5660	DFS		DFS		DFS				DFS
136	5680	DFS		DFS		DFS				DFS
140	5700	DFS		DFS		DFS				DFS
5725-5875 MHz										
149	5745	Yes	Yes			DFS	Yes		Yes	Yes
153	5765	Yes	Yes			DFS	Yes		Yes	Yes
157	5785	Yes	Yes			DFS	Yes		Yes	Yes
161	5805	Yes	Yes			DFS	Yes		Yes	Yes
165	5825	Yes	Yes				Yes		Yes	Yes
<b>Note</b>	Channels marked Yes/DFS are channels supported in that domain. Channels marked DFS are additional DFS-enabled channels and require checks for radar detection. This table is for up to 8 -Bi antennas. For higher gain antennas, see <a href="http://www.cisco.com/en/US/docs/wireless/access_point/channels/lwapp/reference/guide/1520_chp.html">http://www.cisco.com/en/US/docs/wireless/access_point/channels/lwapp/reference/guide/1520_chp.html</a> .									

With the expansion of the channel set, DFS-enabled channels are also supported. Radar detection and automatic channel reassignment in case of radar detection on RAP/MAPs are also supported. When there is a channel change, it is also propagated to the corresponding parent/child access point (if applicable) so that the channel change is synchronized between the parent and child so that there is no link downtime. For example, if radar is detected on the uplink radio of a child access point, the parent is informed so that it can change the channel

of the downlink radio. The parent in turn informs the child about the channel change, so that the child access point can set the new channel on its uplink radio as well and does not have to scan again to rejoin the parent on the new channel.

For countries in the Middle East such as Saudi Arabia and Kuwait, a new regulatory domain for outdoor APs, the -M domain, has been mandated. With this release, outdoor APs will now support this new -M domain. Earlier, these countries were part of the -E domain, which supported a channel set of 100 to 140. However, in the -M domain, channels 149 to 161 are also supported with the 100 to 140 band. Also, in the -M domain, channels 149 to 161 are DFS enabled, unlike other domains such as -A, -C, -N, and so on, where these channels are non-DFS. Radar detection is also enabled on these channels. Because the countries that are now part of the -M domain (that is, Saudi Arabia and Kuwait) were earlier part of the -E domain, both the -E domain and the -M domain APs are supported, when any of these countries is configured on the controller, which ensures backward compatibility with the existing -E domain APs in these countries. However, you will have to ensure that only a valid set of channels (the channels common to both the -E and the -M domains) is selected as part of the 802.11a DCA list, and that the backhaul channel deselection feature is enabled to ensure correct operation of the -E domain APs, as these APs can support 100 to 140 channels and not the extended list of 149 to 161 channels available in the -M domain.

## Discontinuation of the 116 and 132 Channels from the UNII-2 Extended Band

With the 7.0 release, in AP1522 and AP1524SB platforms, in addition to the 5 channels in the upper ISM band, there are 3 channels in the UNII-2 band and 8 channels in the UNII-2 Extended band. There are 11 channels in the UNII-2 Extended band, but only 8 are applicable in the outdoors due to stringent dynamic frequency selection (DFS) conditions for Canada because Canada requires a channel availability check every 10 minutes compared to every 60 seconds in the USA. The 120 (5600 MHz), 124 (5620 MHz), and 128 (5640 MHz) channels have had to be dropped.

The Federal Communications Commission (FCC) has issued a guideline to protect Terminal Doppler Weather Radar (TDWR) systems operating in the 5600- to 5650-MHz band from interference. Also, the UNII-2 Wi-Fi operating channels are interfering with the TDWR band. Therefore, with the 7.0.116.0 release, the 116 and 132 channels are dropped in addition to the 120, 124, and 128 channels. The guidelines also require that you avoid operation in the TDWR band and operate at least 30 MHz away from the TDWR operation frequencies when devices are installed within 35 km (about 21 miles) or the line-of-sight of the TDWR sites.



### Note

Your outdoor installation should be registered in the outdoor database. No fee is required to register your company. The TDWR location sites can be found on the Internet.



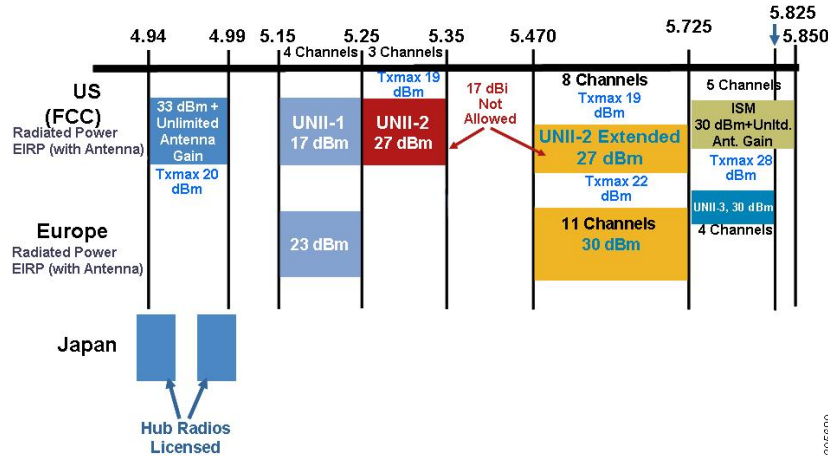
### Note

The FCC, the National Telecommunications and Information Administration (NTIA), and the Federal Aviation Administration (FAA) are continuing to investigate and eliminate cases of interference to TDWRs. For more information about FCC guidelines for outdoor installations, see [http://www.cisco.com/en/US/prod/collateral/routers/ps272/data\\_sheet\\_c78-647116\\_ps11451\\_Products\\_Data\\_Sheet.html](http://www.cisco.com/en/US/prod/collateral/routers/ps272/data_sheet_c78-647116_ps11451_Products_Data_Sheet.html).

## Frequency Bands

Both the 2.4-GHz and 5-GHz frequency bands are supported on the indoor and outdoor access points. Additionally, the 4.9-GHz public safety band is supported on AP1524PS.

**Figure 8: Frequency Bands Supported By 802.11a Radios on AP1520s**



The 5-GHz band is a conglomerate of three bands in the USA: 5.150 to 5.250 (UNII-1), 5.250 to 5.350 (UNII-2), 5.470 to 5.725 (UNII-2 Extended), and 5.725 to 5.850 (ISM). UNII-1 and the UNII-2 bands are contiguous and are treated by 802.11a as being a continuous swath of spectrum 200-MHz wide, more than twice the size of the 2.4-GHz band (see [Table 6: Frequency Band](#), on page 25).

The 4.9 GHz is a public safety channel within the 5-MHz (channels 1 to 10), 10-MHz (channels 11 to 19), and 20-MHz (channels 20 to 26) bandwidths.

The -D domain, which is the country domain for India, supports the following:

- 20-MHz channels—169 (5.845 GHz) and 173 (5.865 GHz)
- 40-MHz channels—The channel pair 169/173 (5.855 GHz)



**Note**

The frequency depends on the regulatory domain in which the access point is installed. For additional information, see the Channels and Power Levels document at [http://www.cisco.com/en/US/docs/wireless/access\\_point/channels/lwapp/reference/guide/lw\\_chp2.html](http://www.cisco.com/en/US/docs/wireless/access_point/channels/lwapp/reference/guide/lw_chp2.html).

**Table 6: Frequency Band**

Frequency Band Terms	Description	Model Support
UNII-1 <sup>4</sup>	Regulations for UNII devices operating in the 5.15- to 5.25-GHz frequency band. Indoor operation only,	1130, 1240, and all 11n Indoor APs

Frequency Band Terms	Description	Model Support
UNII-2	Regulations for UNII devices operating in the 5.25- to 5.35-GHz frequency band. DFS and TPC are mandatory in this band.	1130, 1240, all 11n indoor APs, 1522, 1524SB, and 1552 (except -A domain)
UNII-2 Extended	Regulations for UNII-2 devices operating in the 5.470 to 5.725 frequency band.	1130, 1240, all 11n indoor APs, 1522, 1524SB, 1552
ISM <sup>5</sup>	Regulations for UNII devices operating in the 5.725 to 5.850 GHz frequency band.	1130, 1240, all 11n indoor APs, 1522, 1524 (AP1524PS and AP1524SB), 1552

<sup>4</sup> UNII refers to the Unlicensed National Information Infrastructure.

<sup>5</sup> ISM refers to Industrial, Scientific and Medical.



**Note**

The 1552 access points support only the ISM band in the -A domain. The 1552 access points support the UNII-2 and UNII-2 Extended bands. The DFS algorithms work as expected. The DFS algorithms can be implemented in the ETSI and other domains, but not in the -A domain. The product certification is pending the FCC approval and it might take up to 4 months to get the product certified. After the product is certified, Cisco will provide new software that will allow the UNII-2 and UNII-2 Extended bands to be used for the 1552 access points in the -A domain.

For regulatory information, see [http://www.cisco.com/en/US/prod/collateral/wireless/ps5679/ps5861/product\\_data\\_sheet0900aecd80537b6a.html](http://www.cisco.com/en/US/prod/collateral/wireless/ps5679/ps5861/product_data_sheet0900aecd80537b6a.html).

## Dynamic Frequency Selection

Previously, devices employing radar operated in frequency subbands without other competing services. However, controlling regulatory bodies are attempting to open and share these bands with new services like wireless mesh LANs (IEEE 802.11).

To protect existing radar services, the regulatory bodies require that devices wishing to share the newly opened frequency subband behave in accordance with the Dynamic Frequency Selection (DFS) protocol. DFS dictates that to be compliant, a radio device must be capable of detecting the presence of radar signals. When a radio detects a radar signal, it is required to stop transmitting to for at least 30 minutes to protect that service. The radio then selects a different channel to transmit on but only after monitoring it. If no radar is detected on the projected channel for at least one minute, then the new radio service device may begin transmissions on that channel.

The AP performs a DFS scan on the new DFS channel for 60 seconds. However, if a neighboring AP is already using that new DFS channel, the AP does not perform the DFS scan.

The process for a radio to detect and identify a radar signal is a complicated task that sometimes leads to incorrect detects. Incorrect radar detections can occur due to a large number of factors, including due to uncertainties of the RF environment and the ability of the access point to reliably detect actual on-channel radar.

The 802.11h standard addresses DFS and Transmit Power Control (TPC) as it relates to the 5-GHz band. Use DFS to avoid interference with radar and TPC to avoid interference with satellite feeder links.



**Note** DFS is mandatory in the USA for 5250 to 5350 and 5470 to 5725 frequency bands. DFS and TPC are mandatory for these same bands in Europe.

**Figure 9: DFS and TPC Band Requirements**

	Frequency (MHz)
1	5150 – 5250
2	5250 – 5350
	5470 – 5725
3	5725 – 5850

## Antennas

### Overview

Antenna choice is a vital component of any wireless network deployment. There are two broad types of antennas:

- Directional
- Omnidirectional

Each type of antenna has a specific use and is most beneficial in specific types of deployments. Because antennas distribute RF signal in large *lobed* coverage areas determined by antenna design, successful coverage is heavily reliant on antenna choice.

An antenna gives a mesh access point three fundamental properties: gain, directivity, and polarization:

- Gain—A measure of the increase in power. Gain is the amount of increase in energy that an antenna adds to an RF signal.
- Directivity—The shape of the transmission pattern. If the gain of the antenna increases, the coverage area decreases. The coverage area or radiation pattern is measured in degrees. These angles are measured in degrees and are called beamwidths.

**Note**

Beamwidth is defined as a measure of the ability of an antenna to focus radio signal energy toward a particular direction in space. Beamwidth is usually expressed in degrees HB (Horizontal Beamwidth); usually, the most important one is expressed in a VB (Vertical Beamwidth) (up and down) radiation pattern. When viewing an antenna plot or pattern, the angle is usually measured at half-power (3 dB) points of the main lobe when referenced to the peak effective radiated power of the main lobe.

**Note**

An 8-dBi antenna transmits with a horizontal beamwidth of 360 degrees, causing the radio waves to disperse power in all directions. Therefore, radio waves from an 8-dBi antenna do not go nearly as far as those radio waves sent from a 17-dBi patch antenna (or a third-party dish) that has a more narrow beamwidth (less than 360 degrees).

- **Polarization**—The orientation of the electric field of the electromagnetic wave through space. Antennas can be polarized either horizontally or vertically, though other kinds of polarization are available. Both antennas in a link must have the same polarization to avoid an additional unwanted loss of signal. To improve the performance, an antenna can sometimes be rotated to alter polarization, which reduces interference. A vertical polarization is preferable for sending RF waves down concrete *canyons*, and horizontal polarization is generally more preferable for wide area distribution. Polarization can also be harnessed to optimize for RF bleed-over when reducing RF energy to adjacent structures is important. Most omnidirectional antennas ship with vertical polarization as their default.

### Antenna Options

A wide variety of antennas are available to provide flexibility when you deploy the mesh access points over various terrains. 5 GHz is used as a backhaul and 2.4 GHz is used for client access.

[Table 7: External 2.4- and 5-GHz Antennas](#), on page 28 lists the supported external 2.4- and 5-GHz antennas for AP1500s.

**Table 7: External 2.4- and 5-GHz Antennas**

Part Number	Model	Gain (dBi)
AIR-ANT2450V-N	2.4-GHz compact omnidirectional <sup>6</sup>	5
AIR-ANT-2455V-N	2.4-GHz compact omnidirectional	5.5
AIR-ANT2480V-N	2.4-GHz omnidirectional	8.0
AIR-ANT5180V-N	5-GHz compact omnidirectional <sup>7</sup>	8.0
	4.9-GHz compact omnidirectional <sup>8</sup>	7.0
AIR-ANT5140V-N	5-GHz right-angle omnidirectional	4.0
AIR-ANT58G10SSA-N	5-GHz sector	9.5



Part Number	Model	Gain (dBi)
AIR-ANT5114P-N	4.9- to 5-GHz patch2	14.0
AIR-ANT5117S-N	4.9- to 5-GHz 90-degree sector2	17.0
AIR-ANT2547V-N	2.4- to 5-GHz dual-band omnidirectional	4 dBi at 2.4 GHz and 7 dBi at 5 GHz

<sup>6</sup> The compact omnidirectional antennas mount directly on the access point.

<sup>7</sup> The compact omnidirectional antennas mount directly on the access point.

<sup>8</sup> Use of the 4.9-GHz band requires a license and may be used only by qualified Public Safety operators as defined in section 90.20 of the FCC rules.

See the *Cisco Aironet Antenna and Accessories Reference Guide* on Cisco antennas and accessories at [http://www.cisco.com/en/US/prod/collateral/wireless/ps7183/ps469/product\\_data\\_sheet09186a008008883b.html](http://www.cisco.com/en/US/prod/collateral/wireless/ps7183/ps469/product_data_sheet09186a008008883b.html)

The deployment and design, limitations and capabilities, and basic theories of antennas as well as installation scenarios, regulatory information, and technical specifications are addressed in detail.

**Table 8: Horizontal and Vertical Beamwidth for Cisco Antennas**, on page 29 summarizes the horizontal and vertical beamwidth for Cisco antennas.

**Table 8: Horizontal and Vertical Beamwidth for Cisco Antennas**

Antenna	Horizontal Beamwidth (degrees)	Vertical Beamwidth (degrees)
AIR-ANT5180V-N	360	16
AIR-ANT58G10SSA-N	60	60
AIR-ANT5114P-N	25	29
AIR-ANT5117S-N	90	8
AIR-ANT2547V-N	360	30

### N-Connectors

All external antennas are equipped with male N-connectors.

AP1552 E/H have three N-connectors to connect dual-band antennas.

AP1552 C/I have no N-connectors as they come with inbuilt antennas.

AP1522 has three separate N-connectors to attach two 2.4-GHz antennas and one N-connector for a 5-GHz antenna.

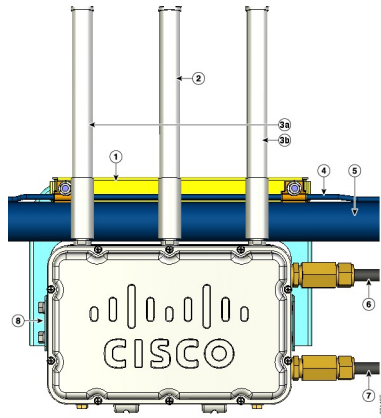
AP1524PS and AP1524SB have five N connectors to attach three 2.4-GHz antennas and two N connectors for 5-GHz/4.9-GHz bands.

Each radio has at least one TX/RX port. Each radio must have an antenna connected to at least one of its available TX/RX ports.

Antenna locations for 5.8 GHz, 4.9 GHz, and 2.4 GHz are fixed and labeled.

This figure shows antenna placement for a two-radio cable mesh access point.

**Figure 10: 1522C Two Radio Cable Mesh Access Point Configuration (Hinged-Side Facing Forward)**



1	Clamp bracket with cable clamps (part of strand mount kit, ordered separately)	5	Cable bundle
2	5-GHz antenna <sup>9</sup> (Tx/Rx)	6	Fiber-optic connection <sup>2</sup>
3a	2.4-GHz antennas <sup>10</sup> (Tx/Rx)	7	Cable POC power input <sup>11</sup>
3b	2.4-GHz antennas (Rx) <sup>2</sup>	8	Strand mount bracket (part of strand mount kit, ordered separately)
4	Strand support cable		

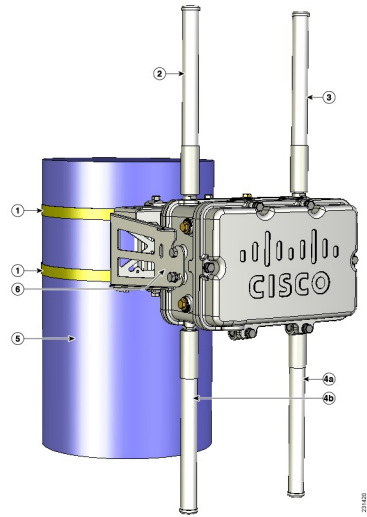
<sup>9</sup> Illustration shows antenna for an access point with two radios.

<sup>10</sup> Liquid tight connector not shown.

<sup>11</sup> Stinger connector shown is user-supplied.

This figure shows antenna placement for a two-radio fiber mesh access point.

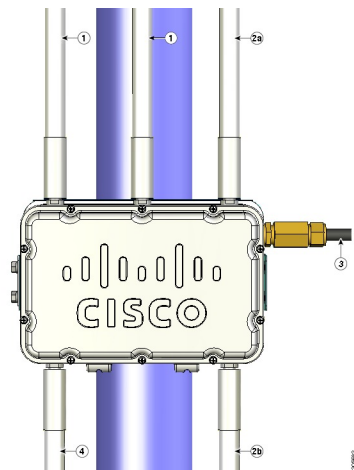
**Figure 11: AP 1522 Two Radio Fiber Mesh Access Point Configuration (Hinged-Side Facing Backward)**



1	Stainless steel mounting straps (part of pole mount kit)	4b	2.4 GHz antennas (Tx/Rx)
2	2.4-GHz antenna (Rx)	5	Pole (wood, metal, or fiberglass), 2 to 16 in. (5.1 to 40.6 cm) diameter
3	5-GHz antenna (Tx/Rx)	6	Mounting bracket (part of pole mount kit)
4a	2.4 GHz antennas (Rx)		

This figure shows antenna placement for a three-radio fiber mesh access point.

**Figure 12: AP1524SB and AP1524PS Mesh Access Point Pole Mount Configuration (Hinged-Side Facing Forward)**



1	2.4-GHz antenna (Rx)	3	Fiber-optic connection
2a	5-GHz antenna (Tx/Rx)	4	5-GHz/4.9-GHz antenna (Tx/Rx)
2b	2.4-GHz antenna (Tx/Rx)		

## Antenna Configurations for 1552

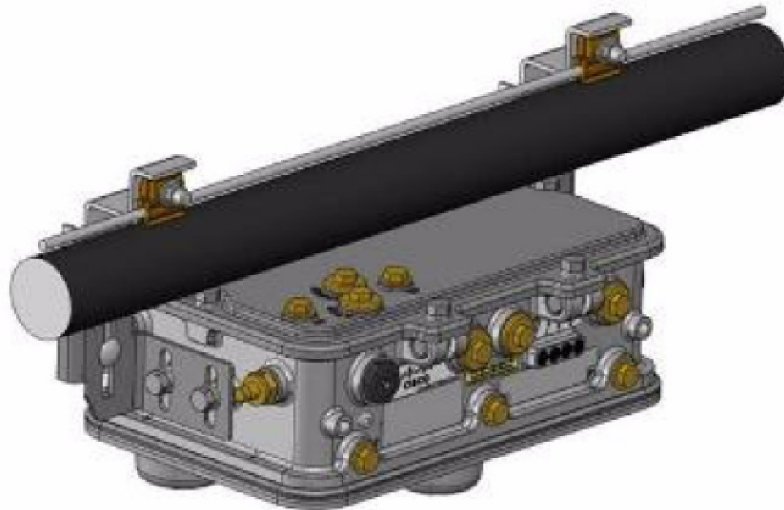
The 1552 access point supports the following two types of antennas designed for outdoor use with radios operating in the 2.4-GHz and 5-GHz frequency:

- Cisco Aironet Low Profile Dual-Band 2.4/5 GHz Dipole Antenna Array (CPN 07-1123-01), an integrated array of three dual-band dipole antennas
- Cisco Aironet Dual-Band Omnidirectional Antenna (AIR-ANT2547V-N), referred to as “stick” antennas

Two types of mounting configurations are available: the cable strand mount and the pole mount.

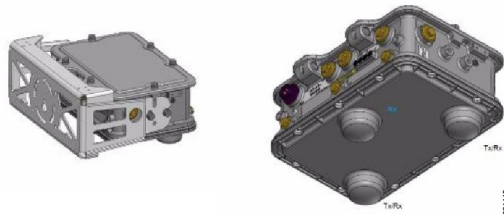
The 1552 models C and I access points are equipped with three new integrated dual-band antennas, with 2 dBi gain at 2.4 GHz and 4 dBi gain at 5 GHz. The antenna works in cable strand mount and low cost, low profile applications.

**Figure 13: 1552C Cable Mount**



331444

**Figure 14: 1552I Pole/Wall Mount**

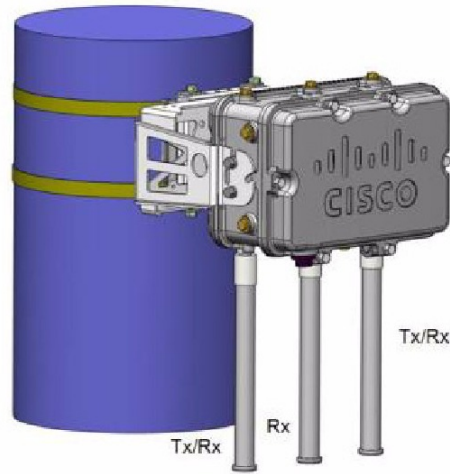


331445

The 1552 E and H access points are equipped with three N-type radio frequency (RF) connectors (antenna ports 4, 5, and 6) on the bottom of the unit for external antennas to support multiple input multiple output (MIMO) operation as shown in the figure below. When using the optional Cisco Aironet AIR-ANT2547V-N

Dual-Band Omnidirectional Antenna, the 2.4- and 5-GHz antennas connect directly to the access point. These antennas have 4 dBi gain at 2.4 GHz and 7 dBi gain at 5 GHz.

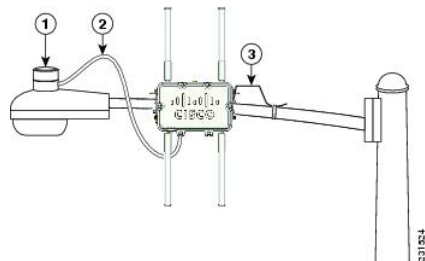
**Figure 15: 1552 E Pole/Wall Mount**



381446

This figure shows one of the recommended installations of an outdoor AP1500.

**Figure 16: Outdoor Pole-top Installation of a Mesh Access Point**



1	Outdoor light control	3	6-AWG copper grounding wire
2	Streetlight power tap adapter		

The AP1500 series was designed building on the long experience we have had in deploying outdoor access points over the past few years. This includes consideration for resistance to lightning effects. The AP1500 series employs some lightning arrestor circuitry on the Ethernet & Power ports. On input Ethernet port, Gas Discharge Tubes (GDT) are used on the Power Entry Module (PEM) to mitigate lightning effect. On the AC Power, GDTs are also used along with fuses to mitigate a high-current condition. For the DC power, a fuse is used to mitigate a high-current condition.

While not a common practice, users may want to consider adding additional lightning protection at the antenna ports for added protection.

## Client Access Certified Antennas (Third-Party Antennas)

You can use third-party antennas with AP1500s. However, note the following:

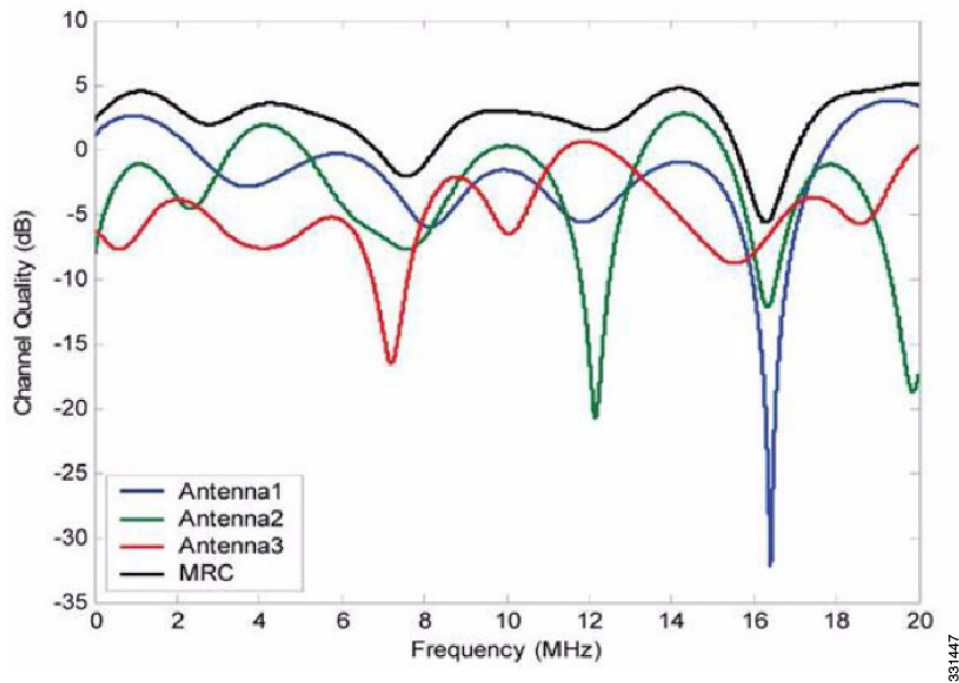
- Cisco does not track or maintain information about the quality, performance, or reliability of the noncertified antennas and cables.
- RF connectivity and compliance is the customer's responsibility.
- Compliance is only guaranteed with Cisco antennas or antennas that are of the same design and gain as Cisco antennas.
- Cisco Technical Assistance Center (TAC) has no training or customer history with regard to nonCisco antennas and cables.

## Maximum Ratio Combining

To understand how this works, consider a single transmitter 802.11a/g client sending an uplink packet to an 802.11n access point with multiple transceivers. The access point receives the signal on each of its three receive antennas.

Each received signal has a different phase and amplitude based on the characteristics of the space between the antenna and the client. The access point processes the three received signals into one reinforced signal by adjusting their phases and amplitudes to form the best possible signal. The algorithm used, called maximum ratio combining (MRC), is typically used on all 802.11n access points. MRC only helps in the uplink direction, enabling the access point to "hear" the client better.

**Figure 17: Reinforcement of Received Signal via MRC Algorithm**



### For the 1520 Series

AP1520 radios have a much higher transmit power, better receiver sensitivity, and broader outdoor temperature range as compared to AP1510 and AP1505 mesh access points.

- The 5-GHz radio (802.11a) is a Single-in-Single-Out (SISO) architecture and the 2.4-GHz radio (802.11 b/g) is 1x3 Single-in-Multiple-Out (SIMO) architecture.
- The 2.4-GHz radio has one transmitter and three receivers. Output power is configurable to 5 levels. With its 3 receivers enabling maximum-ratio combining (MRC), this radio has better sensitivity and range than a typical SISO 802.11b/g radio for OFDM rates.

When operating with data rates higher than 12 Mbps, you can increase gain on a 2.4-GHz radio to 2.7 dB by adding two antennas and to 4.5 dB, by adding three antennas. For information about RX sensitivities and MRC gain, see [Table 9: RX Sensitivities and MRC Gain](#), on page 36.

**Table 9: RX Sensitivities and MRC Gain**

Modulation Rate	Typical sensitivity (dBm)			MRC gain	
	One antenna	Two antennas MRC	Three antennas MRC	Two antennas	Three antennas
1	-92.0	-92.0	-92.0	0.0	0.0
2	-91.0	-91.0	-91.0	0.0	0.0
5.5	-90.3	-90.3	-90.3	0.0	0.0
11	-90.0	-90.0	-90.0	0.0	0.0
6	-90.3	-90.3	-90.3	0.0	0.0
9	-90.3	-90.3	-90.3	0.0	0.0
12	-89.0	-89.5	-90.0	0.5	1.0
18	-88.0	-89.5	-90.0	1.5	2.0
24	-84.3	-87.0	-88.3	2.7	4.0
36	-81.3	-84.0	-85.8	2.7	4.5
48	-77.3	-80.0	-81.8	2.7	4.5
54	-76.0	-78.7	-80.5	2.7	4.5

### For the 1550 Series

In the 1552 series mesh access point, MRC gain is different than the 1520 series mesh access points. The 1520 series access points do not have 802.11n functionality. In the 2.4-GHz band, it has only one transmitter and up to three receivers. Therefore, it is SIMO (Single in Multiple out) in 2.4 GHz. In the 5-GHz band, it



has only one transmitter and one receiver. Therefore, it is SISO (Single in Single out) in the 5-GHz band. The MRC gain is important only for the 2.4-GHz radio in the 1552 access points. The MRC is not available for the 5-GHz radio. The 2.4-GHz radio has one Tx and up to three Rx antennas depending on the AP configuration.

In the 1522 access points, users have an option to use one, two, or three 2.4-GHz Rx antennas. With this option, users get around 3 dB MRC gain with 2 Rx antennas and a 4.5-dB MRC gain with 3 Rx antennas for data rates of 24 Mbps or higher.

For the 1552 access points, both the 2.4- and 5-GHz radios are 2x3 MIMO. Therefore, they have two transmitters and three receivers. Because the antennas are dual band and there is no option to have less than three Rx antennas, the MRC is added to the RX sensitivity always as it is embedded into the baseband chipset.

The number for typical Rx sensitivity in our customer data sheet assume 3 Rx antennas for both the 1520 and the 1550 series access points.

With the chipset used in the AP1520 series radios, there was a start-of-packet problem at lower data rates that wiped out the gain. Therefore, the MRC gain became useful from a data rate of 12 Mbps onwards in the 1520 series access points. This problem has been corrected in the current chipset used in the 1552 access points. The MRC gain has improved for lower data rates as well in the 1552 access points. You get a 4.7-dB improvement in sensitivity with the 2x3 MIMO radio over a 1x1 SISO implementation.

[Table 10: AP1552 11a/g MRC Gain, on page 37](#) and [Table 11: AP1552 11n MRC Gain, on page 37](#) list the MRC gain for the AP1552 11a/g and AP1552 11n respectively.

**Table 10: AP1552 11a/g MRC Gain**

11a/g MCS (Mbps)	Modulation	MRC Gain from 3 RXs (dB)
6	BPSK 1/2	4.7
9	BPSK 3/4	4.7
12	QPSK 1/2	4.7
18	QPSK 3/4	4.7
24	16QAM 1/2	4.7
36	16QAM 3/4	4.7
48	64QAM 2/3	4.7
54	64QAM 3/4	4.7

**Table 11: AP1552 11n MRC Gain**

No. of Spatial Streams	11n MCS	Modulation	MRC Gain from 3 RXs (dB)
1	MCS 0	BPSK 1/2	4.7
1	MCS 1	QPSK 1/2	4.7
1	MCS 2	QPSK 3/4	4.7

No. of Spatial Streams	11n MCS	Modulation	MRC Gain from 3 RXs (dB)
1	MCS 3	16QAM 1/2	4.7
1	MCS 4	16QAM 3/4	4.7
1	MCS 5	64QAM 2/3	4.7
1	MCS 6	64QAM 3/4	4.7
1	MCS 7	64QAM 5/6	4.7
2	MCS 8	BPSK 1/2	1.7
2	MCS 9	QPSK 1/2	1.7
2	MCS 10	QPSK 3/4	1.7
2	MCS 11	16QAM 1/2	1.7
2	MCS 12	16QAM 3/4	1.7
2	MCS 13	64QAM 2/3	1.7
2	MCS 14	64QAM 3/4	1.7
2	MCS 15	64QAM 5/6	1.7

**Note**

With two spatial streams, the MRC gain is halved, that is the MRC gain is reduced by 3 dB. This is because the system has  $10 \log(3/2 \text{ SS})$  instead of  $10 \log(3/1 \text{ SS})$ . If there were to have been 3 SS with 3 RX, then the MRC gain would have been zero.

## Cisco 1500 Hazardous Location Certification

The standard AP1500 enclosure is a ruggedized, hardened enclosure that supports the NEMA 4X and IP67 standards for protection to keep out dust, damp and water.

### Hazardous Certification (Class 1, Div 2, and Zone 2)

To operate in occasional hazardous environments, such as oil refineries, oil fields, drilling platforms, chemical processing facilities, and open-pit mining, special certification is required and the certification is labeled as Class 1, Div 2, or Zone 2.



**Note** For USA and Canada, this certification is CSA Class 1, Division 2. For Europe (EU), it is ATEX or IEC Class 1, Zone 2.

Cisco has Hazardous Certified SKUs for USA and EU: AIR-LAP1522HZ-x-K9, AIR-LAP1524HZ-x-K9, and AIR-LAP1552H-x-K9. These SKUs are modified, as per the certification requirements. The hazardous locations certificate requires that all electrical power cables be run through conduit piping to protect against accidental damage to the electrical wiring that could cause a spark and possible explosion. Access points for hazardous locations contain an internal electrical mounting connect that receives discrete wires from a conduit interface coupler entering from the side of the housing. After the electrical wiring is installed, a cover housing is installed over the electrical connector to prevent exposure to the electrical wiring. The outside of the housing has a hazardous location certification label (CSA, ATEX, or IEC) that identifies the type of certifications and environments that the equipment is approved for operation.



**Note** Power entry module for CSA (USA and Canada) is Power Entry Module, Groups A, B, C, and D with T5v(120° C) temp code. Power Entry Module for ATEX (EU) is Power entry module Groups IIC, IIB, IIA with T5 (120° C) temp code.

#### Hazardous Certification (Div 1 > Div 2 and Zone 1 > Zone 2)

Class 1, Division 1/Zone 1 is for environments with full-time ignitable concentrations of flammable gases, vapors, or liquids. To meet the requirements of the Div 1 > Div 2 and Zone 1 > Zone 2 locations, we recommend a TerraWave Solutions CSA certified protective Wi-Fi enclosure (see [Table 12: TerraWave Enclosures, on page 39](#)).

**Table 12: TerraWave Enclosures**

Access Points	Enclosure Part No	Description
Indoor Mesh Access Points (Cisco Aironet 1040, 1130, 1140, 1240, 1250, 1260, 3500e, and 3500i series access points)	Example: TerraWave XEP1242 for 1240 series.	18 x12 x8 Protective Wi-Fi Enclosure that includes the Cisco 1242 Access Point
Outdoor Mesh Access Points (1522, 1524, 1552)	Example: TerraWave Part Number: XEP1522	18 x 12 x8 Protective Wi-Fi Enclosure that includes the Cisco 1522 Access Point

For more information about the TerraWave enclosures, see [http://www.tessco.com/yts/partner/manufacture\\_list/vendors/terrawave/pdf/terrawavehazardouesenclosuresjan08.pdf](http://www.tessco.com/yts/partner/manufacture_list/vendors/terrawave/pdf/terrawavehazardouesenclosuresjan08.pdf)

[Table 13: Hardware Features at a Glance, on page 40](#) lists the hardware features across different AP1500 models at a glance.

**Table 13: Hardware Features at a Glance**

Features	1552E	1552H	1552C	1552I	152X (1522, 1524SB, 1524PS)
Number of radios	2	2	2	2	2 (1522), 3 (1524)
External Antennas	Yes	Yes	—	—	Yes
Internal Antennas	—	—	Yes	Yes	—
CleanAir 2.4-GHz radio	Yes	Yes	Yes	Yes	—
CleanAir 5-GHz radio	—	—	—	—	—
Beam Forming (ClientLink)	Yes	Yes	Yes	Yes	—
Fiber SFP	Yes	Yes	—	—	Yes
802.3af PoE out port	Yes	Yes	—	—	Yes
DOCSIS 3.0 Cable Modem	—	—	Yes	—	—
DOCSIS 2.0 Cable Modem	—	—	—	—	Yes
HazLoc Class 1 Div 2/Zone 2	—	Yes	—	—	Yes
Battery backup option	Yes	Yes	—	—	Yes
Power options	AC, DC, Power Injector	AC, DC, Power Injector	40 to 90 VAC Power over Cable	AC, DC	AC, DC, 40 to 90 VAC Power over Cable
Heater	—	—	—	—	Yes (1522C)
Console Port Ext. Access	Yes	Yes	Yes	Yes	Yes <b>Note</b> You need to open the access point.



**Note** PoE-in is not 802.3af and does not work with PoE 802.3af-capable Ethernet switch. It requires Power Injector.

# Cisco Wireless LAN Controllers

The wireless mesh solution is supported on Cisco 2500, 5500, and 8500 Series Wireless LAN Controllers.

For more information about the Cisco 2500, 5500, and 8500 Series Wireless LAN Controllers, see [http://www.cisco.com/en/US/products/ps6302/Products\\_Sub\\_Category\\_Home.html](http://www.cisco.com/en/US/products/ps6302/Products_Sub_Category_Home.html).

## Cisco Prime Infrastructure

The Cisco Prime Infrastructure provides a graphical platform for wireless mesh planning, configuration, and management. Network managers can use the Prime Infrastructure to design, control, and monitor wireless mesh networks from a central location.

With the Prime Infrastructure, network administrators have a solution for RF prediction, policy provisioning, network optimization, troubleshooting, user tracking, security monitoring, and wireless LAN systems management. Graphical interfaces make wireless LAN deployment and operations simple and cost-effective. Detailed trending and analysis reports make the Prime Infrastructure vital to ongoing network operations.

The Prime Infrastructure runs on a server platform with an embedded database, which provides scalability that allows hundreds of controllers and thousands of Cisco mesh access points to be managed. Controllers can be located on the same LAN as the Prime Infrastructure, on separate routed subnets, or across a wide-area connection.

## Architecture

### Control and Provisioning of Wireless Access Points

Control and provisioning of wireless access points (CAPWAP) is the provisioning and control protocol used by the controller to manage access points (mesh and nonmesh) in the network. In release 5.2, CAPWAP replaced lightweight access point protocol (LWAPP).

**Note**

---

CAPWAP significantly reduces capital expenditures (CapEx) and operational expenses (OpEx), which enables the Cisco wireless mesh networking solution to be a cost-effective and secure deployment option in enterprise, campus, and metropolitan networks.

---

### CAPWAP Discovery on a Mesh Network

The process for CAPWAP discovery on a mesh network is as follows:

- 1 A mesh access point establishes a link before starting CAPWAP discovery, whereas a nonmesh access point starts CAPWAP discovery using a static IP for the mesh access point, if any.
- 2 The mesh access point initiates CAPWAP discovery using a static IP for the mesh access point on the Layer 3 network or searches the network for its assigned primary, secondary, or tertiary controller. A maximum of 10 attempts are made to connect.

**Note**

---

The mesh access point searches a list of controllers configured on the access point (primed) during setup.

---

- 3 If Step 2 fails after 10 attempts, the mesh access point falls back to DHCP and attempts to connect in 10 tries.
- 4 If both Steps 2 and 3 fail and there is no successful CAPWAP connection to a controller, then the mesh access point falls back to LWAPP.
- 5 If there is no discovery after attempting Steps 2, 3, and 4, the mesh access point tries the next link.

## Dynamic MTU Detection

If the MTU is changed in the network, the access point detects the new MTU value and forwards that to the controller to adjust to the new MTU. After both the access point and the controller are set at the new MTU, all data within their path are fragmented into the new MTU. The new MTU size is used until it is changed. The default MTU on switches and routers is 1500 bytes.

## XML Configuration File

Mesh features within the controller's boot configuration file are saved in an XML file in ASCII format. The XML configuration file is saved in the flash memory of the controller.

**Note**

---

The current release does not support binary configuration files; however, configuration files are in the binary state *immediately* after an upgrade from a mesh release to controller software release 7.0. After reset, the XML configuration file is selected.

---

**Caution**

---

Do not edit the XML file. Downloading a modified configuration file onto a controller causes a cyclic redundancy check (CRC) error on boot and the configuration is reset to the default values.

---

You can easily read and modify the XML configuration file by converting it to CLI format. To convert from XML to CLI format, upload the configuration file to a TFTP or an FTP server. The controller initiates the conversion from XML to CLI during the upload.

Once on the server, you can read or edit the configuration file in CLI format. Then, you can download the file back to the controller. The controller converts the configuration file back to XML format, saves it to flash memory, and reboots using the new configuration.

The controller does not support uploading and downloading of port configuration CLI commands. If you want to configure the controller ports, enter the relevant commands summarized below:

**Note**

The commands listed below are manually entered after the software upgrade to release 7.0.

- **config port linktrap** *{port | all}* *{enable | disable}*—Enables or disables the up and down link traps for a specific controller port or for all ports.
- **config port adminmode** *{port | all}* *{enable | disable}*—Enables or disables the administrative mode for a specific controller port or for all ports.
- **config port multicast appliance** *port* *{enable | disable}*—Enables or disables the multicast appliance service for a specific controller port.
- **config port power** *{port | all}* *{enable | disable}*—Enables or disables power over Ethernet (PoE) for a specific controller port or for all ports.

CLI commands with known keywords and proper syntax are converted to XML while improper CLI commands are ignored and saved to flash memory. Any field with an invalid value is filtered out and set to a default value by the XML validation engine. Validation occurs during bootup.

To see any ignored commands or invalid configuration values, enter the following command:

```
show invalid-config
```

**Note**

You can only execute this command before either the **clear config** or **save config** command. If the downloaded configuration contains a large number of invalid CLI commands, you might want to upload the invalid configuration to the TFTP or FTP server for analysis.

Access passwords are hidden (obfuscated) in the configuration file. To enable or disable access point or controller passwords, enter the following command:

```
config switchconfig secret-obfuscation {enable | disable}
```

## Adaptive Wireless Path Protocol

The Adaptive Wireless Path Protocol (AWPP) is designed specifically for wireless mesh networking to provide ease of deployment, fast convergence, and minimal resource consumption.

AWPP takes advantage of the CAPWAP WLAN, where client traffic is tunneled to the controller and is therefore hidden from the AWPP process. Also, the advance radio management features in the CAPWAP WLAN solution are available to the wireless mesh network and do not have to be built into AWPP.

AWPP enables a remote access point to dynamically find the best path back to a RAP for each MAP that is part of the RAP's bridge group (BGN). Unlike traditional routing protocols, AWPP takes RF details into account.

To optimize the route, a MAP actively solicits neighbor MAP. During the solicitation, the MAP learns all of the available neighbors back to a RAP, determines which neighbor offers the best path, and then synchronizes with that neighbor. The path decisions of AWPP are based on the link quality and the number of hops.

AWPP automatically determines the best path back to the CAPWAP controller by calculating the cost of each path in terms of the signal strength and number of hops. After the path is established, AWPP continuously monitors conditions and changes routes to reflect changes in conditions. AWPP also performs a smoothing

function to signal condition information to ensure that the ephemeral nature of RF environments does not impact network stability.

## Traffic Flow

The traffic flow within the wireless mesh can be divided into three components:

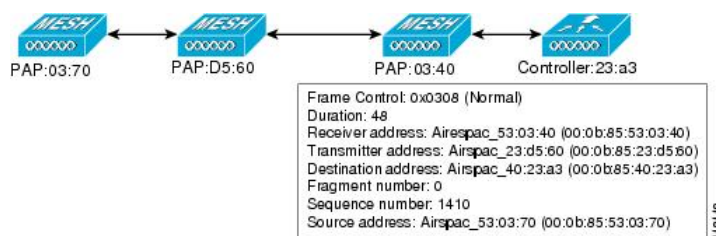
- 1 Overlay CAPWAP traffic that flows within a standard CAPWAP access point deployment; that is, CAPWAP traffic between the CAPWAP access point and the CAPWAP controller.
- 2 Wireless mesh data frame flow.
- 3 AWPP exchanges.

As the CAPWAP model is well known and the AWPP is a proprietary protocol, only the wireless mesh data flow is described. The key to the wireless mesh data flow is the address fields of the 802.11 frames being sent between mesh access points.

An 802.11 data frame can use up to four address fields: receiver, transmitter, destination, and source. The standard frame from a WLAN client to an AP uses only three of these address fields because the transmitter address and the source address are the same. However, in a WLAN bridging network, all four address fields are used because the source of the frame might not be the transmitter of the frame, because the frame might have been generated by a device *behind* the transmitter.

Figure 18: Wireless Mesh Frame, on page 44 shows an example of this type of framing. The source address of the frame is MAP:03:70, the destination address of this frame is the controller (the mesh network is operating in Layer 2 mode), the transmitter address is MAP:D5:60, and the receiver address is RAP:03:40.

**Figure 18: Wireless Mesh Frame**



As this frame is sent, the transmitter and receiver addresses change on a hop-by-hop basis. AWPP is used to determine the receiver address at each hop. The transmitter address is known because it is the current mesh access point. The source and destination addresses are the same over the entire path.

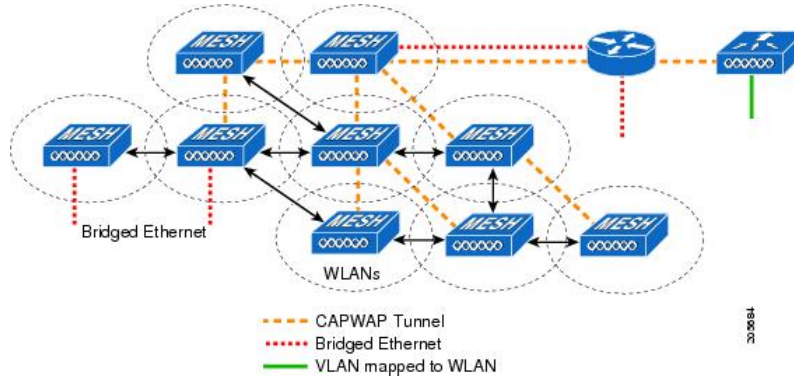
If the RAP's controller connection is Layer 3, the destination address for the frame is the default gateway MAC address, because the MAP has already encapsulated the CAPWAP in the IP packet to send it to the controller, and is using the standard IP behavior of using ARP to find the MAC address of the default gateway.

Each mesh access point within the mesh forms a CAPWAP session with a controller. WLAN traffic is encapsulated inside CAPWAP and is mapped to a VLAN interface on the controller. Bridged Ethernet traffic



can be passed from each Ethernet interface on the mesh network and does not have to be mapped to an interface on the controller (see [Figure 19: Logical Bridge and WLAN Mapping](#), on page 45).

**Figure 19: Logical Bridge and WLAN Mapping**

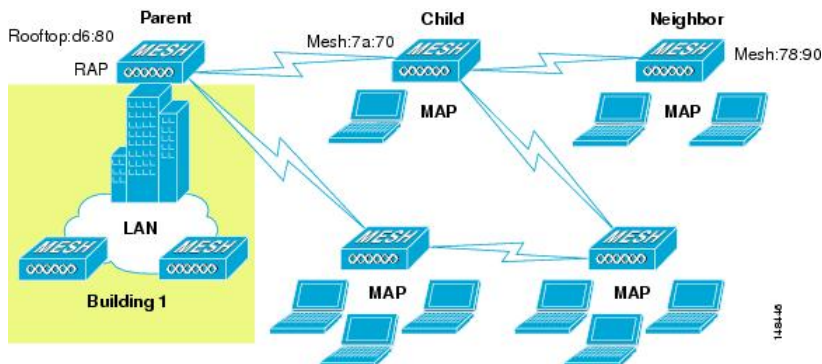


## Mesh Neighbors, Parents, and Children

Relationships among mesh access points are as a parent, child, or neighbor (see [Figure 20: Parent, Child, and Neighbor Access Points](#), on page 45).

- A parent access point offers the best route back to the RAP based on its ease values. A parent can be either the RAP itself or another MAP.
  - Ease is calculated using the SNR and link hop value of each neighbor. Given multiple choices, generally an access point with a higher ease value is selected.
- A child access point selects the parent access point as its best route back to the RAP.
- A neighbor access point is within RF range of another access point but is not selected as its parent or a child because its ease values are lower than that of the parent.

**Figure 20: Parent, Child, and Neighbor Access Points**



## Criteria to Choose the Best Parent

AWPP follows this process in selecting parents for a RAP or MAP with a radio backhaul:

- A list of channels with neighbors is generated by passive scanning in the *scan* state, which is a subset of all backhaul channels.
- The channels with neighbors are sought by actively scanning in the *seek* state and the backhaul channel is changed to the channel with the best neighbor.
- The parent is set to the best neighbor and the parent-child handshake is completed in the *seek* state.
- Parent maintenance and optimization occurs in the *maintain* state.

This algorithm is run at startup and whenever a parent is lost and no other potential parent exists, and is usually followed by CAPWAP network and controller discovery. All neighbor protocol frames carry the channel information.

Parent maintenance occurs by the child node sending a directed NEIGHBOR\_REQUEST to the parent and the parent responding with a NEIGHBOR\_RESPONSE.

Parent optimization and refresh occurs by the child node sending a NEIGHBOR\_REQUEST broadcast on the same channel on which its parent resides, and by evaluating all responses from neighboring nodes on the channel.

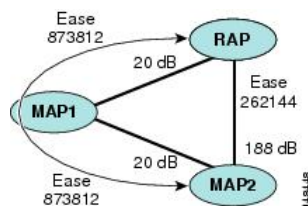
A parent mesh access point provides the best path back to a RAP. AWPP uses ease to determine the best path. Ease can be considered the opposite of cost, and the preferred path is the path with the higher ease.

## Ease Calculation

Ease is calculated using the SNR and hop value of each neighbor, and applying a multiplier based on various SNR thresholds. The purpose of this multiplier is to apply a spreading function to the SNRs that reflects various link qualities.

Figure 21: Parent Path Selection, on page 46 shows the parent path selection where MAP2 prefers the path through MAP1 because the adjusted ease value (436906) though this path is greater then the ease value (262144) of the direct path from MAP2 to RAP.

**Figure 21: Parent Path Selection**



## Parent Decision

A parent mesh access point is chosen by using the adjusted ease, which is the ease of each neighbor divided by the number of hops to the RAP:

adjusted ease = min (ease at each hop) Hop count

### SNR Smoothing

One of the challenges in WLAN routing is the ephemeral nature of RF, which must be considered when analyzing an optimal path and deciding when a change in path is required. The SNR on a given RF link can change substantially from moment to moment, and changing route paths based on these fluctuations results in an unstable network, with severely degraded performance. To effectively capture the underlying SNR but remove moment-to-moment fluctuations, a smoothing function is applied that provides an adjusted SNR.

In evaluating potential neighbors against the current parent, the parent is given 20 percent of bonus-ease on top of the parent's calculated ease, to reduce the ping-pong effect between parents. A potential parent must be significantly better for a child to make a switch. Parent switching is transparent to CAPWAP and other higher-layer functions.

### Loop Prevention

To ensure that routing loops are not created, AWPP discards any route that contains its own MAC address. That is, routing information apart from hop information contains the MAC address of each hop to the RAP; therefore, a mesh access point can easily detect and discard routes that loop.





## Mesh Deployment Modes

---

This chapter describes the mesh deployment modes and contains the following sections:

- [Wireless Mesh Network, page 49](#)
- [Wireless Backhaul, page 49](#)
- [Point-to-Multipoint Wireless Bridging, page 50](#)
- [Point-to-Point Wireless Bridging, page 51](#)

### Wireless Mesh Network

In a Cisco wireless outdoor mesh network, multiple mesh access points comprise a network that provides secure, scalable outdoor wireless LAN.

The three RAPs are connected to the wired network at each location and are located on the building roof. All the downstream access points operate as MAPs and communicate using wireless links (not shown).

Both MAPs and RAPs can provide WLAN client access; however, the location of RAPs are often not suitable for providing client access. All the three access points in are located on the building roofs and are functioning as RAPs. These RAPs are connected to the network at each location.

Some of the buildings have onsite controllers to terminate CAPWAP sessions from the mesh access points but it is not a mandatory requirement because CAPWAP sessions can be back hauled to a controller over a wide-area network (WAN).



**Note**

---

CAPWAP over CAPWAP is not supported.

---

### Wireless Backhaul

In a Cisco wireless backhaul network, traffic can be bridged between MAPs and RAPs. This traffic can be from wired devices that are being bridged by the wireless mesh or CAPWAP traffic from the mesh access points. This traffic is always AES encrypted when it crosses a wireless mesh link such as a wireless backhaul.

AES encryption is established as part of the mesh access point neighbor relationship with other mesh access points. The encryption keys used between mesh access points are derived during the EAP authentication process.

Only 5 GHz backhaul is possible on all mesh access points except 1522 in which either 2.4 or 5 GHz radio can be configured as a backhaul radio (see [Configuring Advanced Features](#)).

## Universal Access

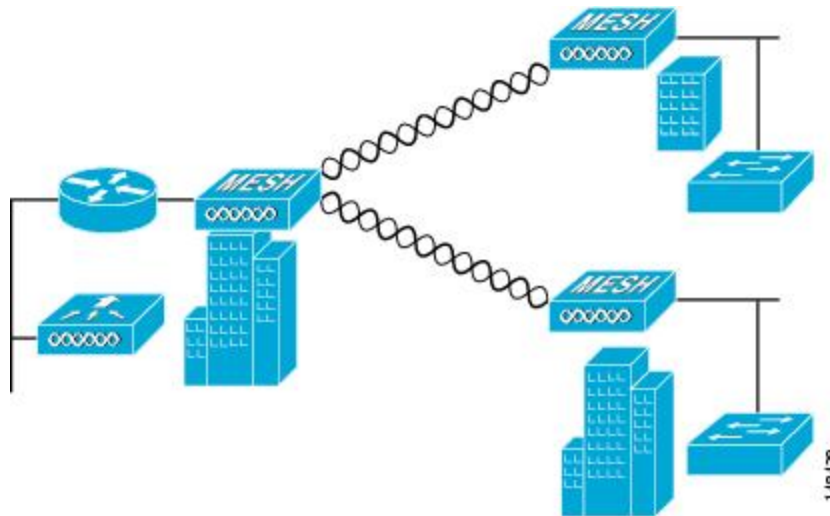
You can configure the backhaul on mesh access points to accept client traffic over its 802.11a radio. This feature is identified as Backhaul Client Access in the controller GUI (Monitor > Wireless). When this feature is disabled, backhaul traffic is transmitted only over the 802.11a or 802.11a/n radio and client association is allowed only over the 802.11b/g or 802.11b/g/n radio. For more information about the configuration, see the [Configuring Advanced Features](#).

## Point-to-Multipoint Wireless Bridging

In the point-to-multipoint bridging scenario, a RAP acting as a root bridge connects multiple MAPs as nonroot bridges with their associated wired LANs. By default, this feature is disabled for all MAPs. If Ethernet bridging is used, you must enable it on the controller for the respective MAP and for the RAP.

This figure shows a simple deployment with one RAP and two MAPs, but this configuration is fundamentally a wireless mesh with no WLAN clients. Client access can still be provided with Ethernet bridging enabled, although if bridging between buildings, MAP coverage from a high rooftop might not be suitable for client access.

**Figure 22: Point-to-Multipoint Bridging Example**

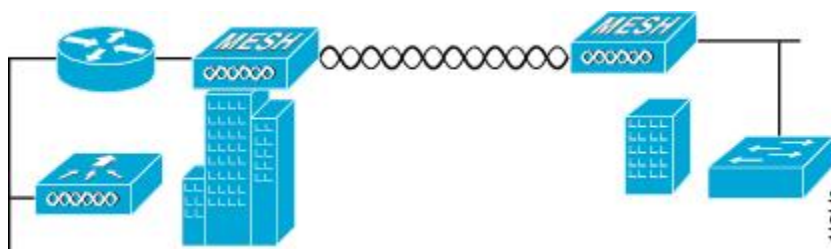


## Point-to-Point Wireless Bridging

In a point-to-point bridging scenario, a 1500 Series Mesh AP can be used to extend a remote network by using the backhaul radio to bridge two segments of a switched network. This is fundamentally a wireless mesh network with one MAP and no WLAN clients. Just as in point-to-multipoint networks, client access can still be provided with Ethernet bridging enabled, although if bridging between buildings, MAP coverage from a high rooftop might not be suitable for client access.

If you intend to use an Ethernet bridged application, we recommend that you enable the bridging feature on the RAP and on all MAPs in that segment. You must verify that any attached switches to the Ethernet ports of your MAPs are not using VLAN Trunking Protocol (VTP). VTP can reconfigure the trunked VLANs across your mesh and possibly cause a loss in connection for your RAP to its primary WLC. An incorrect configuration can take down your mesh deployment.

**Figure 23: Point-to-Point Bridging Example**



For security reasons the Ethernet port on the MAPs is disabled by default. It can be enabled only by configuring Ethernet bridging on the Root and the respective MAPs. To enable Ethernet bridging using the controller GUI, choose **Wireless > All APs > Details for the AP** page, click the **Mesh** tab, and then select the **Ethernet Bridging** check box.



### Note

The overall throughput of backhaul radio decreases by half for each hop of a mesh tree. When the Ethernet-bridged clients are used in MAPs and heavy traffic is passed, it may result in a high throughput consumption, which may cause the downlink MAPs to disassociate from the network due to throughput starvation.

Ethernet bridging has to be enabled for the following two scenarios:

When you want to use the mesh nodes as bridges.

When you want to connect Ethernet devices such as a video camera on the MAP using its Ethernet port.

Ensure that you enable Ethernet bridging for every parent mesh AP taking the path from the mesh AP in question to the controller. For example, if you enable Ethernet bridging on MAP2 in Hop 2, then you must also enable Ethernet bridging on MAP1 (parent MAP), and on the RAP connecting to the controller.

To configure range parameters for longer links, choose **Wireless > Mesh**. Optimum distance (in feet) should exist between the root access point (RAP) and the farthest mesh access point (MAP). Range from the RAP bridge to the MAP bridge has to be mentioned in feet.

The following global parameter applies to all mesh access points when they join the controller and all existing mesh access points in the network:

Range: 150 to 132,000 feet

Default: 12,000 feet

## Configuring Mesh Range (CLI)

- To configure the distance between the nodes doing the bridging, enter the **config mesh range** command. APs reboot after you specify the range.



### Note

To estimate the range and the AP density, you can use range calculators that are available at:

Cisco 1520 Series Outdoor Mesh Range Calculation Utility: [http://www.cisco.com/en/US/products/ps8368/products\\_implementation\\_design\\_guides\\_list.html](http://www.cisco.com/en/US/products/ps8368/products_implementation_design_guides_list.html)

Range Calculator for 1550 Series Outdoor Mesh Access Points: [http://www.cisco.com/en/US/products/ps11451/products\\_implementation\\_design\\_guides\\_list.html](http://www.cisco.com/en/US/products/ps11451/products_implementation_design_guides_list.html)

- To view the mesh range, enter the **show mesh config** command.

## Assumptions for the AP1522 Range Calculator

- The AP1522 Range Calculator has been edited to stay within limitations for Tx power and EIRP under the listed regulatory domains. There may be cases where it exceeds the limitations. You must verify that the installation is within the laws of the location in which it is being installed.
- When you use the AP1522 Range Calculator, available power levels change based upon the regulatory domain, the antenna (or antenna gain) selected, the modulation mode, which is based on the data rate selected (OFDM requires a lower power level in some domains). You must verify all parameters after making any parameter changes.
- Rx sensitivity in 2.4 GHz is the composite sensitivity of all three Rx paths. That is, MRC is included in 2.4 GHz. There is only one Rx for 5 GHz.
- You can choose only the channels that the access point is certified for.
- You can select only valid power levels.

## Assumptions for the AP1552 Range Calculator

- The AP1552 Range Calculator has been edited to stay within limitations for Tx power and EIRP under the listed regulatory domains. There may be cases where it exceeds the limitations. You must verify that the installation is within the laws of the location in which it is being installed.
- All three antenna ports must be used for external antenna models of 1552 for effective performance. Otherwise, range is significantly compromised. 1552 radios have two Tx paths and three Rx paths.
- The Tx power is the total composite power of both Tx paths.
- Rx sensitivity is the composite sensitivity of all three Rx paths. That is, MRC is included.
- The AP1552 Range Calculator assumes that ClientLink (Beamforming) is switched on.



- You can select a different antenna than the two that are available by default. If you enter a high gain antenna and choose a power that goes over the EIRP limit, then you get a warning and the range equals 0.
- You can choose only the channels that the access point is certified for.
- You can only select only valid power levels.





## Design Considerations

---

This chapter describes important design considerations and provides an example of a wireless mesh design.

Each outdoor wireless mesh deployment is unique, and each environment has its own challenges with available locations, obstructions, and available network infrastructure. Design requirements driven by expected users, traffic, and availability needs are also major design criteria. This chapter contains the following sections:

- [Wireless Mesh Constraints](#), page 55
- [ClientLink Technology](#), page 59
- [Controller Planning](#), page 62

### Wireless Mesh Constraints

The following are a few system characteristics to consider when you design and build a wireless mesh network. Some of these characteristics apply to the backhaul network design and others to the CAPWAP controller design:

### Wireless Backhaul Data Rate

Backhaul is used to create only the wireless connection between the access points. The backhaul interface by default is 802.11a or 802.11a/n depending upon the access point. The rate selection is important for effective use of the available RF spectrum. The rate can also affect the throughput of client devices, and throughput is an important metric used by industry publications to evaluate vendor devices.

Dynamic Rate Adaptation (DRA) introduces a process to estimate optimal transmission rate for packet transmissions. It is important to select rates correctly. If the rate is too high, packet transmissions fail resulting in communication failure. If the rate is too low, the available channel bandwidth is not used, resulting in inferior products, and the potential for catastrophic network congestion and collapse.

Data rates also affect the RF coverage and network performance. Lower data rates, for example 6 Mbps, can extend farther from the access point than can higher data rates, for example 300 Mbps. As a result, the data rate affects cell coverage and consequently the number of access points required. Different data rates are achieved by sending a more redundant signal on the wireless link, allowing data to be easily recovered from noise. The number of symbols sent out for a packet at the 1-Mbps data rate is higher than the number of

symbols used for the same packet at 11 Mbps. Therefore, sending data at the lower bit rates takes more time than sending the equivalent data at a higher bit rate, resulting in reduced throughput.

A lower bit rate might allow a greater distance between MAPs, but there are likely to be gaps in the WLAN client coverage, and the capacity of the backhaul network is reduced. An increased bit rate for the backhaul network either requires more MAPs or results in a reduced SNR between MAPs, limiting mesh reliability and interconnection.

**Note**

The data rate can be set on the backhaul on a per AP basis. It is not a global command.

The required minimum LinkSNR for backhaul links per data rate is shown in [Table 14: Backhaul Data Rates and Minimum LinkSNR Requirements](#), on page 56.

**Table 14: Backhaul Data Rates and Minimum LinkSNR Requirements**

802.11a Data Rate (Mbps)	Minimum Required LinkSNR (dB)
54	31
48	29
36	26
24	22
18	18
12	16
9	15
6	14

- The required minimum LinkSNR value is driven by the data rate and the following formula: *Minimum SNR + fade margin*.

[Table 15: Backhaul Data Rates and Minimum LinkSNR Requirements for 802.11n](#), on page 56 summarizes the calculation by data rate.

- Minimum SNR refers to an ideal state of noninterference, nonnoise, and a system packet error rate (PER) of no more than 10 percent.
- Typical fade margin is approximately 9 to 10 dB.

Minimum Required LinkSNR Calculations by Data Rate

**Table 15: Backhaul Data Rates and Minimum LinkSNR Requirements for 802.11n**

802.11n Date Rate (Mbps)	Spatial Stream	Minimum Required LinkSNR (dB)
15	1	9.3

802.11n Date Rate (Mbps)	Spatial Stream	Minimum Required LinkSNR (dB)
30	1	11.3
45	1	13.3
60	1	17.3
90	1	21.3
120	1	24.3
135	1	26.3
157.5	1	27.3
30	2	12.3
60	2	14.3
90	2	16.3
120	2	20.3
180	2	24.3
240	2	27.3
270	2	29.3
300	2	30.3

- If we take into account the effect of MRC for calculating Minimum Required Link SNR. [Table 16: Required LinkSNR Calculations for 802.11a/g, on page 57](#) shows the required LinkSNR for 802.11a/g (2.4 GHz and 5 GHz) for AP1552 and 1522 with 3 Rx antennas (MRC gain).

$$\text{LinkSNR} = \text{Minimum SNR} - \text{MRC} + \text{Fade Margin (9 dB)}$$

**Table 16: Required LinkSNR Calculations for 802.11a/g**

802.11a/g MCS (Mbps)	Modulation	Minimum SNR (dB)	MRC Gain from 3 RXs (dB)	Fade Margin (dB)	Required Link SNR (dB)
6	BPSK 1/2	5	4.7	9	9.3
9	BPSK 3/4	6	4.7	9	10.3
12	QPSK 1/2	7	4.7	9	11.3
18	QPSK 3/4	9	4.7	9	13.3

802.11a/g MCS (Mbps)	Modulation	Minimum SNR (dB)	MRC Gain from 3 RXs (dB)	Fade Margin (dB)	Required Link SNR (dB)
24	16QAM 1/2	13	4.7	9	17.3
36	16QAM 3/4	17	4.7	9	21.3
48	64QAM 2/3	20	4.7	9	24.3
54	64QAM 3/4	22	4.7	9	26.3

If we consider only 802.11n rates, then [Table 17: Requirements for LinkSNR with AP1552 for 2.4 and 5 GHz](#), on page 58 shows LinkSNR requirements with AP1552 for 2.4 and 5 GHz.

**Table 17: Requirements for LinkSNR with AP1552 for 2.4 and 5 GHz**

No. of Spatial Streams	11n MCS	Modulation	Minimum SNR (dB)	MRC Gain from 3 RXs (dB)	Fade Margin (dB)	Link SNR (dB)
1	MCS 0	BPSK 1/2	5	4.7	9	9.3
1	MCS 1	QPSK 1/2	7	4.7	9	11.3
1	MCS 2	QPSK 3/4	9	4.7	9	13.3
1	MCS 3	16QAM 1/2	13	4.7	9	17.3
1	MCS 4	16QAM 3/4	17	4.7	9	21.3
1	MCS 5	64QAM 2/3	20	4.7	9	24.3
1	MCS 6	64QAM 3/4	22	4.7	9	26.3
1	MCS 7	64QAM 5/6	23	4.7	9	27.3
2	MCS 8	BPSK 1/2	5	1.7	9	12.3
2	MCS 9	QPSK 1/2	7	1.7	9	14.3
2	MCS 10	QPSK 3/4	9	1.7	9	16.3
2	MCS 11	16QAM 1/2	13	1.7	9	20.3
2	MCS 12	16QAM 3/4	17	1.7	9	24.3
2	MCS 13	64QAM 2/3	20	1.7	9	27.3
2	MCS 14	64QAM 3/4	22	1.7	9	29.3

No. of Spatial Streams	11n MCS	Modulation	Minimum SNR (dB)	MRC Gain from 3 RXs (dB)	Fade Margin (dB)	Link SNR (dB)
2	MCS 15	64QAM 5/6	23	1.7	9	30.3

**Note**

With two spatial streams, the MRC gain is halved, that is the MRC gain is reduced by 3 dB. This is because the system has  $10 \log(3/2 \text{ SS})$  instead of  $10 \log(3/1 \text{ SS})$ . If there were to have been 3 SS with 3 RX, then the MRC gain would have been zero.

- Number of backhaul hops is limited to eight but we recommend three to four hops.

The number of hops is recommended to be limited to three or four primarily to maintain sufficient backhaul throughput, because each mesh access point uses the same radio for transmission and reception of backhaul traffic, which means that throughput is approximately halved over every hop. For example, the maximum throughput for 24 Mbps is approximately 14 Mbps for the first hop, 9 Mbps for the second hop, and 4 Mbps for the third hop.

- Number of MAPs per RAP.

There is no current software limitation on how many MAPs per RAP you can configure. However, it is suggested that you limit the number to 20 MAPs per RAP.

- Number of controllers

- The number of controllers per mobility group is limited to 72.

- Number of mesh access points supported per controller.

## ClientLink Technology

Many networks still support a mix of 802.11a/g and 802.11n clients. Because 802.11a/g clients (legacy clients) operate at lower data rates, the older clients can reduce the capacity of the entire network. Cisco's ClientLink technology can help solve problems related to adoption of 802.11n in mixed-client networks by ensuring that 802.11a/g clients operate at the best possible rates, especially when they are near cell boundaries.

Advanced signal processing has been added to the Wi-Fi chipset. Multiple transmit antennas are used to focus transmissions in the direction of the 802.11a/g client, increasing the downlink signal-to-noise ratio and the data rate over range, thereby reducing coverage holes and enhancing the overall system performance. This technology learns the optimum way to combine the signal received from a client and then uses this information to send packets in an optimum way back to the client. This technique is also referred to as MIMO (multiple-input multiple-output) beamforming, transmit beamforming, or cophasing, and it is the only enterprise-class and service provider-class solution in the market that does not require expensive antenna arrays.

The 802.11n systems take advantage of multipath by sending multiple radio signals simultaneously. Each of these signals, called a spatial stream, is sent from its own antenna using its own transmitter. Because there is some space between these antennas, each signal follows a slightly different path to the receiver, a situation called spatial diversity. The receiver has multiple antennas as well, each with its own radio that independently decodes the arriving signals, and each signal is combined with signals from the other receiver radios. This

results in multiple data streams receiving at the same time. This enables a higher throughput than previous 802.11a/g systems, but requires an 802.11n capable client to decipher the signal. Therefore, both AP and client need to support this capability. Due to the complexity of issues, in the first generation of mainstream 802.11n chipsets, neither the AP nor client chipsets implemented 802.11n transmit beamforming. Therefore, the 802.11n standard transmit beamforming will be available eventually, but not until the next generation of chipsets take hold in the market. We intend to lead in this area going forward.

We realized that for the current generation of 802.11n APs, while the second transmit path was being well utilized for 802.11n clients (to implement spatial diversity), it was not being fully used for 802.11a/g clients. In other words, for 802.11 a/g clients, some of the capabilities of the extra transmit path was lying idle. In addition, we realized that for many networks, the performance of the installed 802.11 a/g client base would be a limiting factor on the network.

To take advantage of this fallow capacity and greatly enhance overall network capacity by bringing 802.11 a/g clients up to a higher performance level, we created an innovation in transmit beamforming technology, called ClientLink.

ClientLink uses advanced signal processing techniques and multiple transmit paths to optimize the signal received by 802.11a/g clients in the downlink direction without requiring feedback. Because no special feedback is required, Cisco ClientLink works with all existing 802.11a/g clients.

Cisco ClientLink technology effectively enables the access point to optimize the SNR exactly at the position where the client is placed. ClientLink provides a gain of almost 4 dB in the downlink direction. Improved SNR yields many benefits, such as a reduced number of retries and higher data rates. For example, a client at the edge of the cell that might previously have been capable of receiving packets at 12 Mbps could now receive them at 36 Mbps. Typical measurements of downlink performance with ClientLink show as much as 65 percent greater throughput for 802.11a/g clients. By allowing the Wi-Fi system to operate at higher data rates and with fewer retries, ClientLink increases the overall capacity of the system, which means an efficient use of spectrum resources.

ClientLink in the 1552 access points is based on ClientLink capability available in AP3500s. Therefore, the access point has the ability to beamform well to nearby clients and to update beamforming information on 802.11ACKs. Therefore, even if there is no dedicated uplink traffic, the ClientLink works well, which is beneficial to both TCP and UDP traffic streams. There are no RSSI watermarks, which the client has to cross to take advantage of this Beamforming with Cisco 802.11n access points.

ClientLink can beamform to 15 clients at a time. Therefore, the host must select the best 15 if the number of legacy clients exceeds 15 per radio. AP1552 has two radios, which means that up to 30 clients can be beamformed in time domain.

Although ClientLink is applied to legacy OFDM portions of packets, which refers to 11a/g rates (not 11b) for both indoor and outdoor 802.11n access points, there is one difference between ClientLink for indoor 11n and ClientLink for outdoor 11n. For indoor 11n access points, SW limits the affected rates to 24, 36, 48, and 54 Mbps. This is done to avoid clients sticking to a far away AP in an indoor environment. SW also does not allow ClientLink to work for those rates for 11n clients because the throughput gain is so minimal. However, there is a demonstrable gain for pure legacy clients. For outdoor 11n access points, we do need more coverage. Thus, three more additional legacy data rates lower than 24 Mbps have been added. ClientLink for outdoors is applicable to legacy data rates of 6, 9, 12, 18, 24, 36, 48, and 54 Mbps.

**Note**

---

ClientLink is enabled by default.

---



## Configuring ClientLink (CLI)

From the 7.2 release onwards, it is not possible to configure ClientLink (beamforming) using the controller GUI.

- 
- Step 1** Disable the 802.11a or 802.11b/g network by entering this command:  
**config {802.11a | 802.11b} disable network**
- Step 2** Globally enable or disable beamforming on your 802.11a or 802.11g network by entering this command:  
**config {802.11a | 802.11b} beamforming global {enable | disable}**  
 The default value is disabled.
- Note** After you enable beamforming on the network, it is automatically enabled for all the radios applicable to that network type.
- Step 3** Override the global configuration and enable or disable beamforming for a specific access point by entering this command:  
**config {802.11a | 802.11b} beamforming ap Cisco\_AP {enable | disable}**  
 The default value is disabled if beamforming is disabled on the network and enabled if beamforming is enabled on the network.
- Step 4** Reenable the network by entering this command:  
**config {802.11a | 802.11b} enable network**
- Step 5** Save your changes by entering this command:  
**save config**
- Step 6** See the beamforming status for your network by entering this command:  
**show {802.11a | 802.11b}**  
 Information similar to the following appears:

```
802.11a Network..... Enabled
11nSupport..... Enabled
802.11a Low Band..... Enabled
802.11a Mid Band..... Enabled
802.11a High Band..... Enabled
...
Pico-Cell-V2 Status..... Disabled
TI Threshold..... -50
Legacy Tx Beamforming setting..... Enabled
```

- Step 7** See the beamforming status for a specific access point by entering this command:  
**show ap config {802.11a | 802.11b} Cisco\_AP**  
 Information similar to the following appears:

```
Cisco AP Identifier..... 14
Cisco AP Name..... 1250-1
Country code..... US - United States
Regulatory Domain allowed by Country..... 802.11bg:-A 802.11a:-A
...
Phy OFDM parameters
```

```

Configuration ..... AUTOMATIC
Current Channel ..... 149
Extension Channel ..... NONE
Channel Width..... 20 Mhz
Allowed Channel List..... 36,40,44,48,52,56,60,64,100,
..... 104,108,112,116,132,136,140,
..... 149,153,157,161,165
TI Threshold ..... -50
Legacy Tx Beamforming Configuration ..... CUSTOMIZED
Legacy Tx Beamforming ..... ENABLED

```

---

## Commands Related to ClientLink

The following commands are related to ClientLink:

- The following commands are to be entered in the AP console:
  - To check the status of Beamforming on the AP, enter the **show controller d0/d1** command.
  - To find a client in the AP rbf table, enter the **show interface dot110** command.
  - To check the Beamforming rate assigned on the AP, enter the **debug d0 trace print rates** command.
- The following commands on the AP console are used for troubleshooting:
  - To show that ClientLink is enabled on a radio, enter the **show controllers | inc Beam** command.

The output is displayed as follows:

```

Legacy Beamforming: Configured Yes, Active Yes, RSSI Threshold -50 dBm
Legacy Beamforming: Configured Yes, Active Yes, RSSI Threshold -60 dBm

```

- To show that ClientLink is Beamforming to a particular client, enter the **show interface dot11radio 1 lbf rbf** command.

The output is displayed as follows:

```

RBF Table:
Index      Client MAC      Reserved      Valid      Tx BF      Aging
1          0040.96BA.45A0  Yes           Yes        Yes        No

```

## Controller Planning

The following items affect the number of controllers required in a mesh network:

- Mesh access points (RAPs and MAPs) in the network.
 

The wired network that connects the RAP and controllers can affect the total number of access points supported in the network. If this network allows the controllers to be equally available to all access points without any impact on WLAN performance, the access points can be evenly distributed across

all controllers for maximum efficiency. If this is not the case, and controllers are grouped into various clusters or PoPs, the overall number of access points and coverage are reduced.

- Number of mesh access points (RAPs and MAPs) supported per controller. See [Table 18: Mesh Access Point Support by Controller Model](#), on page 63.

For clarity, nonmesh access points are referred to as *local* access points in this document.

**Table 18: Mesh Access Point Support by Controller Model**

Controller Model	Local AP Support (nonmesh) <sup>12</sup>	Maximum Possible Mesh AP Support
5508 <sup>13</sup>	500	500
2504 <sup>14</sup>	50	50
WiSM2	500	500

<sup>12</sup> Local AP support is the total number of nonmesh APs supported on the controller model.

<sup>13</sup> For 5508, controllers, the number of MAPs is equal to (local AP support - number of RAPs).

<sup>14</sup> For 2504, controllers, the number of MAPs is equal to (local AP support - number of RAPs).



**Note**

Mesh is fully supported on Cisco 5508 Controllers. The Base License (LIC-CT508-Base) is sufficient for indoor and outdoor APs (AP152X). The WPlus License (LIC-WPLUS-SW) is merged with the base license. The WPlus License is not required for indoor mesh APs.





## Site Preparation and Planning

---

This chapter describes the site preparation and planning for your mesh network and contains the following sections:

- [Site Survey, page 65](#)
- [Wireless Mesh Network Coverage Considerations, page 75](#)
- [Indoor Mesh Interoperability with Outdoor Mesh, page 101](#)

### Site Survey

We recommend that you perform a radio site survey before installing the equipment. A site survey reveals problems such as interference, Fresnel zone, or logistics problems. A proper site survey involves temporarily setting up mesh links and taking measurements to determine whether your antenna calculations are accurate. Determine the correct location and antenna before drilling holes, routing cables, and mounting equipment.



**Note**

---

When power is not readily available, we recommend you to use an unrestricted power supply (UPS) to temporarily power the mesh link.

---

### Pre-Survey Checklist

Before attempting a site survey, determine the following:

- How long is your wireless link?
- Do you have a clear line of sight?
- What is the minimum acceptable data rate within which the link runs?
- Is this a point-to-point or point-to-multipoint link?
- Do you have the correct antenna?
- Can the access point installation area support the weight of the access point?

- Do you have access to both of the mesh site locations?
- Do you have the proper permits, if required?
- Do you have a partner? Never attempt to survey or work alone on a roof or tower.
- Have you configured the 1500 series before you go onsite? It is always easier to resolve configuration or device problems first.
- Do you have the proper tools and equipment to complete your task?

**Note**

---

Cellular phones or handheld two-way radios can be helpful to do surveys.

---

## Outdoor Site Survey

Deploying WLAN systems outdoors requires a different skill set to indoor wireless deployments. Considerations such as weather extremes, lightning, physical security, and local regulations need to be taken into account.

When determining the suitability of a successful mesh link, define how far the mesh link is expected to transmit and at what radio data rate. Remember that the data rate is not directly included in the wireless routing calculation, and we recommend that the same data rate is used throughout the same mesh (the recommended rate is 24 Mbps).

Design recommendations for mesh links are as follows:

- MAP deployment cannot exceed 35 feet in height above the street.
- MAPs are deployed with antennas pointed down toward the ground.
- Typical 5-GHz RAP-to-MAP distances are 1000 to 4000 feet.
- RAP locations are typically towers or tall buildings.
- Typical 5-GHz MAP-to-MAP distances are 500 to 1000 feet.
- MAP locations are typically short building tops or streetlights.
- Typical 2.4-GHz MAP-to-client distances are 500 to 1000 feet (depends upon the type of access point).
- Clients are typically laptops, Smart Phones, Tablets, and CPEs. Most of the clients operate in the 2.4-GHz band.

## Determining a Line of Sight

When you determine the suitability of a successful link, you must define how far the link is expected to transmit and at what radio data rate. Very close links, one kilometer or less, are fairly easy to achieve assuming there is a *clear line of sight (LOS)*—a path with no obstructions.

Because mesh radio waves have very high frequency in the 5-GHz band, the radio wavelength is small; therefore, the radio waves do not travel as far as radio waves on lower frequencies, given the same amount of power. This higher frequency range makes the mesh ideal for unlicensed use because the radio waves do not travel far unless a high-gain antenna is used to tightly focus the radio waves in a given direction.

This high-gain antenna configuration is recommended only for connecting a RAP to the MAP. To optimize mesh behavior, omnidirectional antennas are used because mesh links are limited to one mile (1.6 km). The curvature of the earth does not impact line-of-sight calculations because the curvature of the earth changes every six miles (9.6 km).

## Weather

In addition to free space path loss and line of sight, weather can also degrade a mesh link. Rain, snow, fog, and any high humidity condition can slightly obstruct or affect the line of sight, introducing a small loss (sometimes referred to as rain fade or fade margin), which has little effect on the mesh link. If you have established a stable mesh link, the weather should not be a problem; however, if the link is poor to begin with, bad weather can degrade performance or cause loss of link.

Ideally, you need a line of sight; a white-out snow storm does not allow a line of sight. Also, while storms may make the rain or snow itself appear to be the problem, many times it might be additional conditions caused by the adverse weather. For example, perhaps the antenna is on a mast pipe and the storm is blowing the mast pipe or antenna structure and that movement is causing the link to come and go, or there might be a large build-up of ice or snow on the antenna.

## Fresnel Zone

A Fresnel zone is an imaginary ellipse around the visual line of sight between the transmitter and receiver. As radio signals travel through free space to their intended target, they could encounter an obstruction in the Fresnel area, degrading the signal. Best performance and range are attained when there is no obstruction of this Fresnel area. Fresnel zone, free space loss, antenna gain, cable loss, data rate, link distance, transmitter power, receiver sensitivity, and other variables play a role in determining how far your mesh link goes. Links can still occur as long as 60 percent to 70 percent of the Fresnel area is unobstructed, as illustrated in [Figure 24: Point-to-Point Link Fresnel Zone](#), on page 67.

**Figure 24: Point-to-Point Link Fresnel Zone**

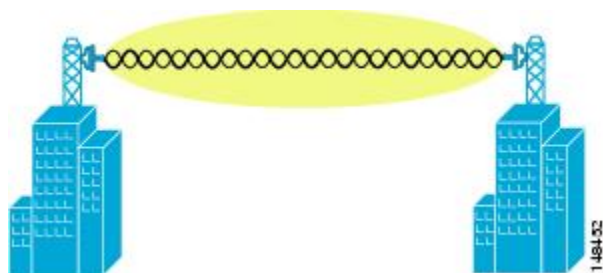
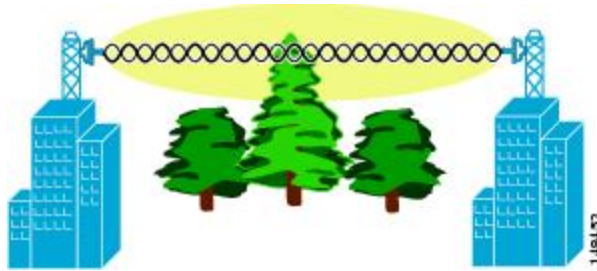


Figure 25: Typical Obstructions in a Fresnel Zone, on page 68 illustrates an obstructed Fresnel zone.

**Figure 25: Typical Obstructions in a Fresnel Zone**



It is possible to calculate the radius of the Fresnel zone (in feet) at any particular distance along the path using the following equation:

$$F1 = 72.6 \times \text{square root} (d/4 \times f)$$

where

F1 = the first Fresnel zone radius in feet

D = total path length in miles

F = frequency (GHz)

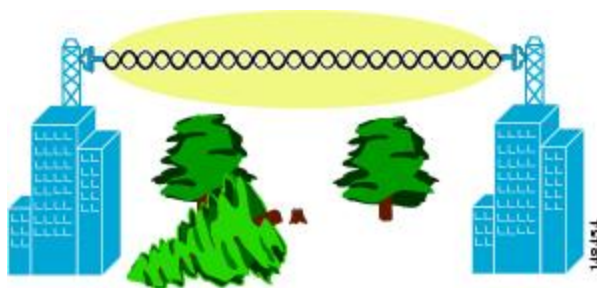
Normally, 60 percent of the first Fresnel zone clearance is recommended, so the above formula for 60 percent Fresnel zone clearance can be expressed as follows:

$$0.60 F1 = 43.3 \times \text{square root} (d/4 \times f)$$

These calculations are based on a flat terrain.

Figure 26: Removing Obstructions in a Fresnel Zone, on page 68 shows the removal of an obstruction in the Fresnel zone of the wireless signal.

**Figure 26: Removing Obstructions in a Fresnel Zone**



## Fresnel Zone Size in Wireless Mesh Deployments

To give an approximation of size of the maximum Fresnel zone to be considered, at a possible minimum frequency of 4.9 GHz, the minimum value changes depending on the regulatory domain. The minimum figure quoted is a possible band allocated for public safety in the USA, and a maximum distance of one mile gives a Fresnel zone of clearance requirement of  $9.78 \text{ ft} = 43.3 \times \text{SQR}(1/(4 \times 4.9))$ . This clearance is relatively easy to achieve in most situations. In most deployments, distances are expected to be less than one mile, and the



frequency greater than 4.9 GHz, making the Fresnel zone smaller. Every mesh deployment should consider the Fresnel zone as part of its design, but in most cases, it is not expected that meeting the Fresnel clearance requirement is an issue.

## Hidden Nodes Interference

The mesh backhaul uses the same 802.11a channel for all nodes in that mesh, which can introduce hidden nodes into the WLAN backhaul environment.

**Figure 27: Hidden Nodes**

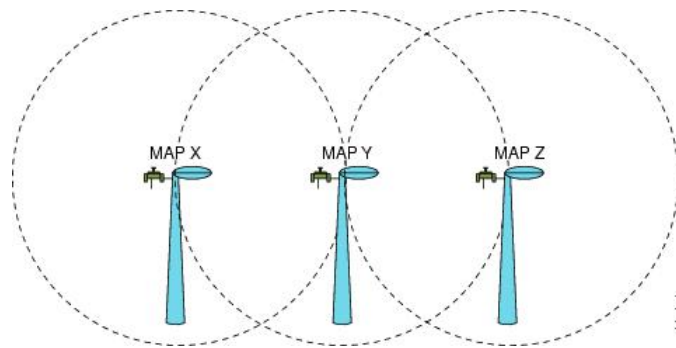


Figure 27: Hidden Nodes, on page 69 shows the following three MAPs:

- MAP X
- MAP Y
- MAP Z

If MAP X is the route back to the RAP for MAP Y and Z, both MAP X and MAP Z might be sending traffic to MAP Y at the same time. MAP Y can see traffic from both MAP X and Z, but MAP X and Z cannot see each other because of the RF environment, which means that the carrier sense multi-access (CSMA) mechanism does not stop MAP X and Z from transmitting during the same time window; if either of these frames is destined for a MAP, it is corrupted by the collision between frames and requires retransmission.

Although all WLANs at some time can expect some hidden node collisions, the fixed nature of the MAP makes hidden node collisions a persistent feature of the mesh WLAN backhaul under some traffic conditions such as heavy loads and large packet streams.

Both the hidden node problem and the exposed node problem are inherent to wireless mesh networks because mesh access points share the same backhaul channel. Because these two problems can affect the overall network performance, the Cisco mesh solution seeks to mitigate these two problems as much as possible. For example, the AP1500s have at least two radios: one for backhaul access on a 5-GHz channel and the other for 2.4-GHz client access. In addition, the radio resource management (RRM) feature, which operates on the 2.4-GHz radio, enables cell breathing and automatic channel change, which can effectively decrease the collision domains in a mesh network.

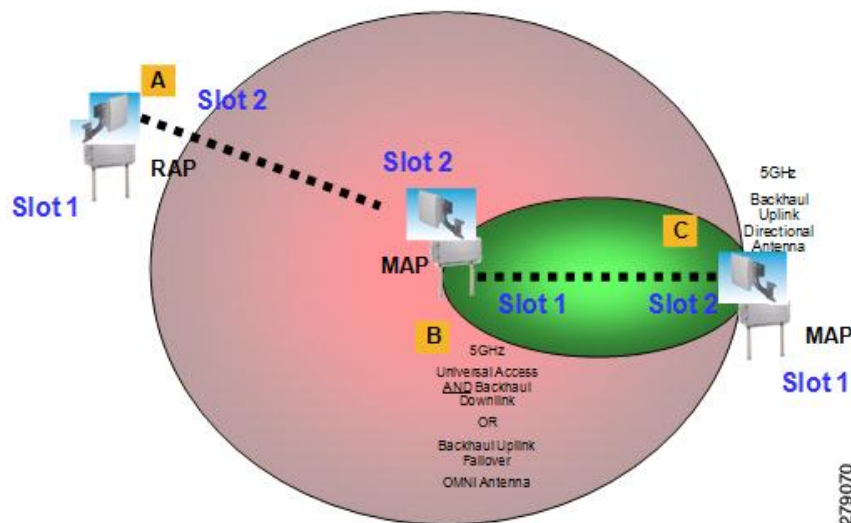
There is an additional solution that can help to further mitigate these two problems. To reduce collisions and to improve stability under high load conditions, the 802.11 MAC uses an exponential backoff algorithm, where contending nodes back off exponentially and retransmit packets whenever a perceived collision occurs. Theoretically, the more retries a node has, the smaller the collision probability will be. In practice, when there are only two contending stations and they are not hidden stations, the collision probability becomes negligible

after just three retries. The collision probability increases when there are more contending stations. Therefore, when there are many contending stations in the same collision domain, a higher retry limit and a larger maximum contention window are necessary. Further, collision probability does not decrease exponentially when there are hidden nodes in the network. In this case, an RTS/CTS exchange can be used to mitigate the hidden node problem.

## Functional Routing of Three Radio MAPs

Because a directional antenna is required to be attached to the slot 2 radios, you should align and RF tune each link to minimize the hidden node effect. For example, a MAP at location C should be aligned to the MAP at location B. The MAP at location C should not be able to see AP at location A. First, align the antennas and then optimize each link by tuning the RF power. A channel is reused after 4 hops. A maximum number of 8 hops is supported.

**Figure 28: Functional Routing Example**



## Slot Bias Options

When a 1524SB AP is switched on, either slot 1 or slot 2 can be used for an uplink depending on the strength of the signal. AWPP treats both slots equally. For a MAP, slot 2 is the preferred (biased) uplink slot, that is, the slot that is used to connect to the parent AP. Slot 1 is the preferred downlink slot. When both radio slots are available for use and if slot 1 is used for an uplink backhaul, a 15-minute timer is started. At the end of 15 minutes, the AP scans for a channel in slot 2 so that slot 2 might be used for an uplink backhaul again. This process is called slot bias.

We recommend that you use directional antenna on slot 2 for a proper linear functionality. We also recommend that you ensure that slot 2 is selected for a strong uplink. However, there may be some scenarios where directional antennas are used on both the backhaul radios for mobility. When the AP is powered on, the parent can be selected in either direction. If slot 1 is selected, the AP should not go to the scanning mode after 15 minutes, that is, you should disable the slot bias.

## Disabling Slot Bias

To disable slot bias so that the APs can be stable on slot 1, enter the **config mesh slot-bias disable** command.



**Note** The slot bias is enabled by default.

### Usage Guidelines

Follow these guidelines for the **config mesh slot-bias disable** command:

- The **config mesh slot-bias disable** command is a global command and is applicable to all 1524SB APs associated with the same controller.
- Slot bias is applicable only when both slot 1 and slot 2 are usable. If a slot radio does not have a channel that is available because of dynamic frequency selection (DFS), the other slot takes up both the uplink and downlink roles.
- If slot 2 is not available because of hardware issues, slot bias functions normally. Take corrective action by disabling the slot bias or fixing the antenna.
- A 15-minute timer is initiated (slot bias) only when slot 1 and slot 2 are usable (have channels to operate).
- The 15-minute timer is not initiated if slot 2 cannot find any channels because of DFS, which results in slot 1 taking over the uplink and the downlink.
- Slot 2 takes over slot 1 if slot 1 does not have any channels to operate because of DFS.
- If slot 2 has a hardware failure, then slot bias is initiated, and slot 1 is selected for uplinking.
- Disabling slot bias enables you to take preventive action for a smooth operation.

## Commands Related to Slot Bias

The following commands related to slot bias:

- To see which slot is being used for an uplink or a downlink, enter the following command:

```
(Cisco Controller) > show mesh config

Mesh Range..... 12000
Mesh Statistics update period..... 3 minutes
Backhaul with client access status..... enabled
Backhaul with extended client access status..... disabled
Background Scanning State..... enabled
Backhaul Amsdu State..... enabled
Mesh Security
  Security Mode..... EAP
  External-Auth..... disabled
  Use MAC Filter in External AAA server..... disabled
  Force External Authentication..... disabled
Mesh Alarm Criteria
  Max Hop Count..... 4
  Recommended Max Children for MAP..... 10
  Recommended Max Children for RAP..... 20
  Low Link SNR..... 12
  High Link SNR..... 60
  Max Association Number..... 10
  Association Interval..... 60 minutes
  Parent Change Numbers..... 3
  Parent Change Interval..... 60 minutes
```

```

Mesh Multicast Mode..... In-Out
Mesh Full Sector DFS..... enabled
Mesh Ethernet Bridging VLAN Transparent Mode..... enabled
Mesh DCA channels for serial backhaul APs..... disabled
Mesh Slot Bias..... disabled

```

- To verify that slot 1 is being used for an uplink, do the following:

Enable debugging on the AP by entering the following command in the controller:

```
(Cisco Controller) > debug ap enable AP_name
```

Enter the following commands in the controller:

```
(Cisco Controller) > debug ap command show mesh config AP_name
```

```
(Cisco Controller) > debug ap command show mesh adjacency parent AP_name
```

## Preferred Parent Selection

You can configure a preferred parent for a MAP. This feature gives more control to you and enables you to enforce a linear topology in a mesh environment. You can skip AWPP and force a parent to go to a preferred parent.

### Preferred Parent Selection Criteria

The child AP selects the preferred parent based on the following criteria:

- The preferred parent is the best parent.
- The preferred parent has a link SNR of at least 20 dB (other parents, however good, are ignored).
- The preferred parent has a link SNR in the range of 12 dB and 20 dB, but no other parent is significantly better (that is, the SNR is more than 20 percent better). For an SNR lower than 12 dB, the configuration is ignored.
- The preferred parent is not blacklisted.
- The preferred parent is not in silent mode because of dynamic frequency selection (DFS).
- The preferred parent is in the same bridge group name (BGN). If the configured preferred parent is not in the same BGN and no other parent is available, the child joins the parent AP using the default BGN.



#### Note

Slot bias and preferred parent selection features are independent of each other. However, with the preferred parent configured, the connection is made to the parent using slot 1 or slot 2, whichever the AP sees first. If slot 1 is selected for the uplink in a MAP, then slot bias occurs. We recommend that you disable slot bias if you already know that slot 1 is going to be selected.

## Configuring a Preferred Parent

To configure a preferred parent, enter the following command:

```
(Cisco Controller) > config mesh parent preferred AP_name MAC
```

where:

- *AP\_name* is the name of the child AP that you have to specify.
- *MAC* is the MAC address of the preferred parent that you have to specify.

**Note**

When you configure a preferred parent, ensure that you specify the MAC address of the actual mesh neighbor for the desired parent. This MAC address is the base radio MAC address that has the letter f as the final character. For example, if the base radio MAC address is 00:24:13:0f:92:00, then you must specify 00:24:13:0f:92:0f as the preferred parent. This is the actual MAC address that is used for mesh neighbor relationships.

The following example shows how to configure the preferred parent for the MAP1SB access point, where 00:24:13:0f:92:00 is the preferred parent's MAC address:

```
(Cisco Controller) > config mesh parent preferred MAP1SB 00:24:13:0f:92:0f
```

To configure a preferred parent using the controller GUI, follow these steps:

- 1 Choose **Wireless > Access Points > AP\_NAME > Mesh**.
- 2 Enter the MAC address of the preferred parent in the **Preferred Parent** text box.

**Note**

To clear the Preferred Parent value, enter none in the Preferred Parent Text box.

- 3 Click **Apply**.

**Note**

When the preferred parent is entered, no other mesh configurations can be made at the same time. You must apply the changes and wait for 90 seconds before other mesh changes can be made.

## Related Commands

The following commands are related to preferred parent selection:

- To clear a configured parent, enter the following command:

```
(Cisco Controller) > config mesh parent preferred AP_name none
```

- To get information about the AP that is configured as the preferred parent of a child AP, enter the following command:

```
(Cisco Controller) > show ap config general AP_name
```

The following example shows how to get the configuration information for the MAP1SB access point, where 00:24:13:0f:92:00 is the MAC address of the preferred parent:

```
(Cisco Controller) > show ap config general MAP1SB
```

```
Cisco AP Identifier..... 9
Cisco AP Name..... MAP1SB
Country code..... US - United States
Regulatory Domain allowed by Country..... 802.11bg:-A 802.11a:-A
AP Country code..... US - United States
AP Regulatory Domain..... 802.11bg:-A 802.11a:-A
Switch Port Number ..... 1
MAC Address..... 12:12:12:12:12:12
IP Address Configuration..... DHCP
IP Address..... 209.165.200.225
IP NetMask..... 255.255.255.224
CAPWAP Path MTU..... 1485
Domain.....
Name Server.....
Telnet State..... Disabled
Ssh State..... Disabled
Cisco AP Location..... default location
Cisco AP Group Name..... default-group
Primary Cisco Switch Name..... 4404
Primary Cisco Switch IP Address..... 209.165.200.230
Secondary Cisco Switch Name.....
Secondary Cisco Switch IP Address..... Not Configured
Tertiary Cisco Switch Name..... 4404
Tertiary Cisco Switch IP Address..... 3.3.3.3
Administrative State ..... ADMIN ENABLED
Operation State ..... REGISTERED
Mirroring Mode ..... Disabled
AP Mode ..... Local
Public Safety ..... Global: Disabled, Local: Disabled
AP subMode ..... WIPS
Remote AP Debug ..... Disabled
S/W Version ..... 5.1.0.0
Boot Version ..... 12.4.10.0
Mini IOS Version ..... 0.0.0.0
Stats Reporting Period ..... 180
LED State..... Enabled
PoE Pre-Standard Switch..... Enabled
PoE Power Injector MAC Addr..... Disabled
Power Type/Mode..... PoE/Low Power (degraded mode)
Number Of Slots..... 2
AP Model..... AIR-LAP1252AG-A-K9
IOS Version..... 12.4(10:0)
Reset Button..... Enabled
AP Serial Number..... serial number
AP Certificate Type..... Manufacture Installed
Management Frame Protection Validation..... Enabled (Global MFP Disabled)
AP User Mode..... CUSTOMIZED
AP username..... maria
AP Dot1x User Mode..... Not Configured
AP Dot1x username..... Not Configured
Cisco AP system logging host..... 255.255.255.255
AP Up Time..... 4 days, 06 h 17 m 22 s
AP LWAPP Up Time..... 4 days, 06 h 15 m 00 s
Join Date and Time..... Mon Mar 3 06:19:47 2008

Ethernet Port Duplex..... Auto
Ethernet Port Speed..... Auto
AP Link Latency..... Enabled
```

```

Current Delay..... 0 ms
Maximum Delay..... 240 ms
Minimum Delay..... 0 ms
Last updated (based on AP Up Time)..... 4 days, 06 h 17 m 20 s
Rogue Detection..... Enabled
AP TCP MSS Adjust..... Disabled
Mesh preferred parent..... 00:24:13:0f:92:00

```

## Co-Channel Interference

In addition to hidden node interference, co-channel interference can also impact performance. Co-channel interference occurs when adjacent radios on the same channel interfere with the performance of the local mesh network. This interference takes the form of collisions or excessive deferrals by CSMA. In both cases, performance of the mesh network is degraded. With appropriate channel management, co-channel interference on the wireless mesh network can be minimized.

## Wireless Mesh Network Coverage Considerations

This section provides a summary of items that must be considered for maximum wireless LAN coverage in an urban or suburban area, to adhere to compliance conditions for respective domains.

The following recommendations assume a flat terrain with no obstacles (green field deployment).

We always recommend that you perform a site survey before taking any real estimations for the area and creating a bill of materials.

## Cell Planning and Distance

### For the Cisco 1520 Series Access Points

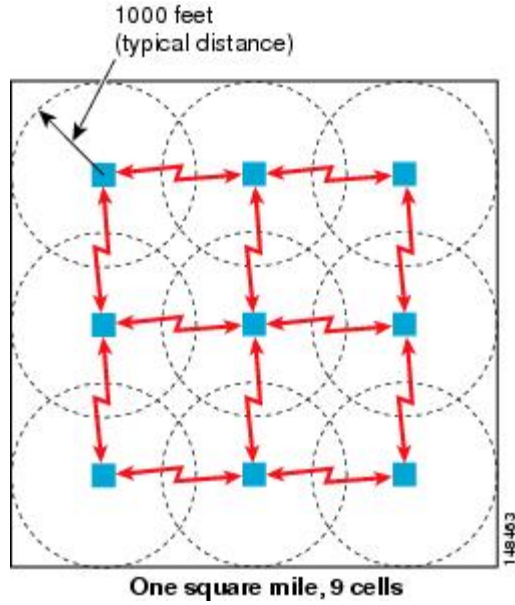
The RAP-to-MAP ratio is the starting point. For general planning purposes, the current ratio is 20 MAPs per RAP.

We recommend the following values for cell planning and distance in nonvoice networks:

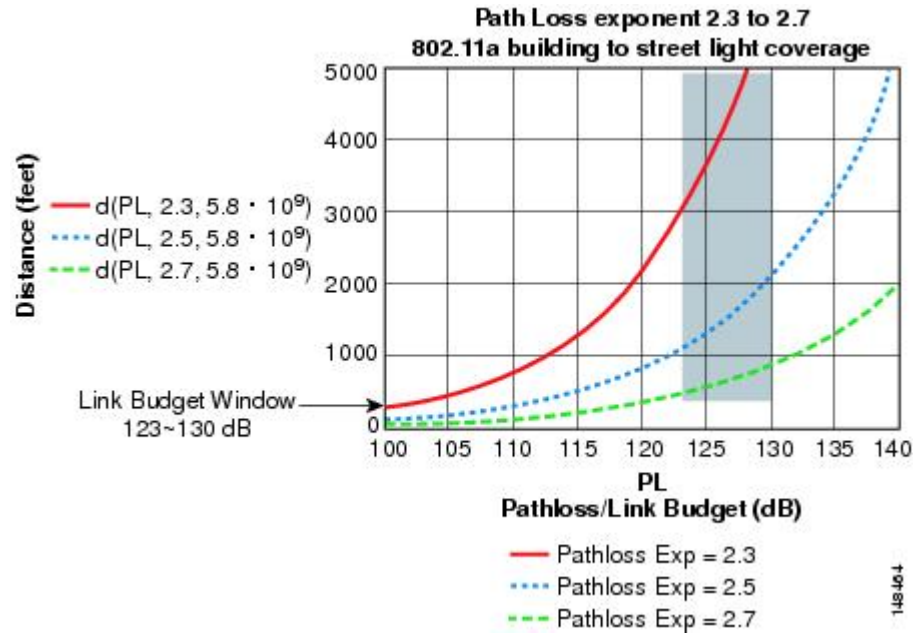
- RAP-to-MAP ratio—Recommended maximum ratio is 20 MAPs per RAP.
- AP-to-AP distance—A spacing of no more than of 2000 feet (609.6 meters) between each mesh access point is recommended. When you extend the mesh network on the backhaul (no client access), use a cell radius of 1000 feet (304.8 meters).
- Hop count—Three to four hops.
  - One square mile in feet (52802), is nine cells and you can cover one square mile with approximately three or four hops (see [Figure 29: Cell Radius of 1000 Feet and Access Point Placement for Nonvoice Mesh Networks](#), on page 76 and [Figure 30: Path Loss Exponent 2.3 to 2.7](#), on page 76.)
- For 2.4 GHz, the local access cell size radius is 600 feet (182.88 meters). One cell size is around 1.310 x 106, so there are 25 cells per square mile. (See [Figure 31: Cell Radius of 600 Feet and Access Point](#)

Placement for Nonvoice Mesh Networks, on page 76 and Figure 32: Path Loss Exponent 2.5 to 3.0, on page 77.)

**Figure 29: Cell Radius of 1000 Feet and Access Point Placement for Nonvoice Mesh Networks**



**Figure 30: Path Loss Exponent 2.3 to 2.7**



**Figure 31: Cell Radius of 600 Feet and Access Point Placement for Nonvoice Mesh Networks**



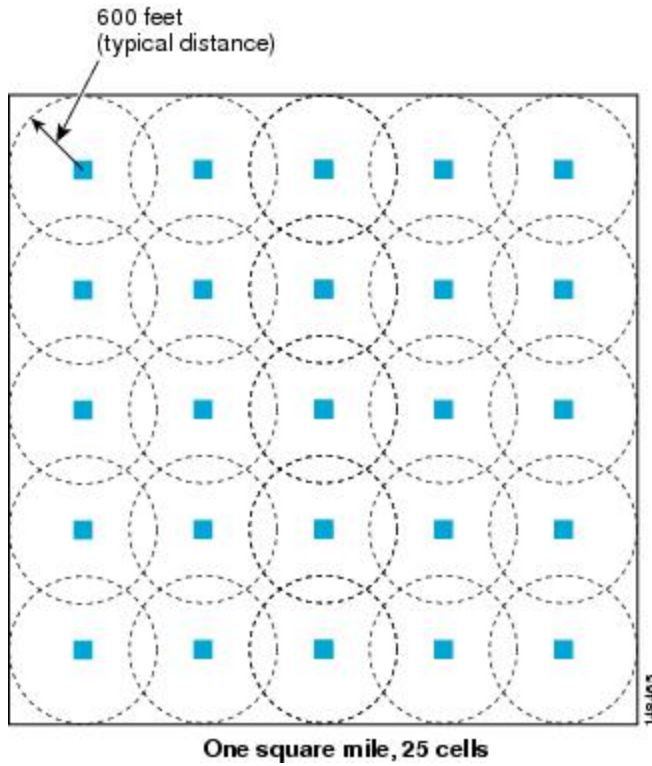
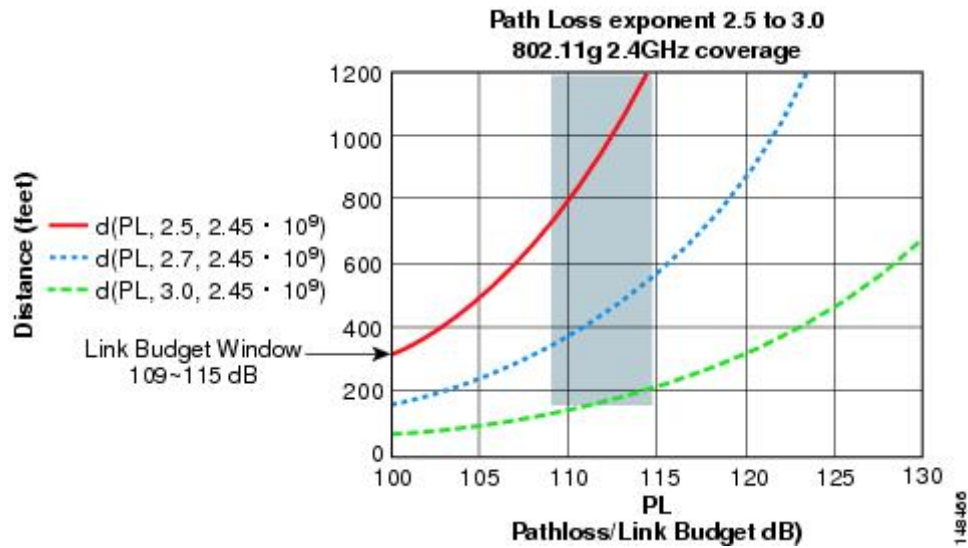


Figure 32: Path Loss Exponent 2.5 to 3.0



**For the Cisco 1550 Series Access Points**

As seen in the previous section, for a Greenfield deployment with the AP1520 series, we recommend a cell radius of 600 feet, and an AP to AP distance of 1200 feet. Normally, an AP to AP distance that is twice the

AP to client distance is recommended. That is, if we halve the AP to AP distance, we will get the approximate cell radius.

The AP1550 series offers comparatively better range and capacity as it has the 802.11n functionality. It has advantages of ClientLink (Beamforming) in downstream, better receiver sensitivities because of MRC in upstream, multiple transmitter streams and a few other advantages of 802.11n such as channel combining and so on. The 1552 access points can provide comparatively larger and higher capacity cells.

**Note**

Link budgets are different for different country domains. The discussion in this section takes into account the most widely distributed and large country domains: -A and -E.

Comparison of Link Budgets of AP1520 Series and AP1552 Series in 2.4- and 5-GHz Bands (-A Domain)

For the 2.4-GHz band 1520s and 1552s have almost the same Tx power, but 1552s have 3 dB better Rx sensitivity because of improved MRC (see [Table 19: Link Budget Comparison for the 2.4-GHz band in -A Domain](#), on page 78).

**Table 19: Link Budget Comparison for the 2.4-GHz band in -A Domain**

Parameter	Cisco 1552 (-A domain)	Cisco 1522 (-A Domain)	Comments
Frequency Band	2412-2462 MHz	2412-2462 MHz	Center Frequencies
Air Interface	802.11b/g/n	802.11b/g	
Channel Bandwidth	20 MHz	20 MHz	
No. of Tx Spatial Streams	2	1	
PHY Data Rates	Up to 144 Mbps <sup>15</sup>	Up to 54 Mbps	
Tx Power Conducted	28 dBm, Composite <sup>16</sup>	27 dBm	Maximum power, data rate dependent
Rx Sensitivity	-94 dBm at 6 Mbps -79 dBm at 54 Mbps -73 dBm at 300 Mbps <sup>17</sup>	-90 dBm at 6 Mbps -80 dBm at 54 Mbps	Includes 4.7 dB MRC gain for AP1552
No. of Receive Channels	3	3	
Rx Diversity	MRC	MRC	
Antenna Cable loss	0.5 dB, with external antenna	0.5 dB	

Parameter	Cisco 1552 (-A domain)	Cisco 1522 (-A Domain)	Comments
Antenna gain without ClientLink (Beamforming)	3 dual-band omnidirectional antenna 1552 E/H: 4 dBi each  1552 C/I: 2 dBi each (3-element low profile Radom)	5.5 dBi or 8 dBi omnidirectional	
Antenna gain with ClientLink (Beamforming)	8 dBi or 6 dBi	5.5 dBi or 8 dBi (No BF)	

<sup>15</sup> 40-MHz channel bonding in 2.4 GHz is not applicable. Therefore, the maximum data rate is 144 Mbps.

<sup>16</sup> Composite power is the power when we have two Tx streams enabled in AP1552.

<sup>17</sup> 1552 has 3 dB better receiver sensitivity when compared to 1520 series APs.



**Note**

AP1552 has almost the same antenna gain with ClientLink (Beamforming) as compared to AP1522s. There is no 20-MHz channel bonding available in the 2.4-GHz band to get the 40-MHz channel as we only have 3 nonoverlapping channels. The maximum data rate that we can achieve in 2.4 GHz is 144 Mbps.

For the 5-GHz band, 1520s and 1552s have almost the same Tx power, but 1552s have approximately 4 dB better Rx sensitivity because of the availability of MRC in 5 GHz (see [Table 20: Link Budget Comparison for the 5-GHz band in -A Domain, on page 79](#)).

**Table 20: Link Budget Comparison for the 5-GHz band in -A Domain**

Parameter	Cisco 1552 (-A Domain)	Cisco 1522 (-A Domain)	Comments
Frequency Band	5745-5825 MHz	5745-5825 MHz	Center Frequencies
Air Interface	802.11a/n	802.11a	
Channel Bandwidth	20 MHz, 40 MHz	20 MHz	
No. of Tx Spatial Streams	2	1	
PHY Data Rates	Up to 300 Mbps	Up to 54 Mbps	
Tx Power Conducted	28 dBm, Composite	28 dBm	Maximum power, data rate dependent
Rx Sensitivity	-92 dBm at 6 Mbps -76 dBm at 54 Mbps -72 dBm at 300 Mbps <sup>18</sup>	-88 dBm at 6 Mbps -73 dBm at 54 Mbps	Includes 4.7 dB MRC gain for AP1552

Parameter	Cisco 1552 (-A Domain)	Cisco 1522 (-A Domain)	Comments
No. of Receive Channels	3	1	
Rx Diversity	MRC	No MRC <sup>19</sup>	
Antenna Cable loss	0.5 dB	0.5 dB	
Antenna gain without ClientLink (Beamforming)	3 dual-band omnidirectional antenna 1552 E/H: 7 dBi each 1552 C/I: 4 dBi each (3 element low profile Radom)	8 dBi, 14 dBi, 17 dBi	
Antenna gain with ClientLink (Beamforming)	11 dBi (omnidirectional), 8 dBi panel array	8 dBi (No BF)	

<sup>18</sup> 1552 has ~4 dB better Rx sensitivity as compared to 1520 series APs.

<sup>19</sup> Maximum Ratio Combining not available for 1522 in 5 GHz.

The 20-MHz channel bonding to form a 40-MHz channel is available in 5 GHz. Therefore, we can go up to a data rate of 300 Mbps.

As discussed in the previous section, Path Loss Exponents (PLE) and Link Budget windows work together. For a full clear path, PLE is 2.0. For AP to AP, there is comparatively more clearance than AP to client. For AP to AP, PLE can be taken as 2.3 because it can be assumed that the height of both APs is about 10 meters, which means a good line of sight (but without Fresnel zone clearance).

For AP to client, PLE should be greater than or equal to 2.5 because the client is only 1 meter high. Therefore, there will be less Fresnel zone clearance. This applies to both the 2.4-GHz and 5-GHz bands.

Let us consider AP to AP link budget in 5 GHz for -A domain because 5 GHz is used as a backhaul for mesh. We can take a legacy data rate of 9 Mbps to estimate the range (see [Table 21: AP to AP RF Link Budget, 5.8 GHz: 9 Mbps \(-A domain\)](#), on page 80).



**Note**

This is the lowest data rate for outdoor 802.11n APs, which carries the Cisco's ClientLink (Beamforming for Legacy clients) advantage. It provides a gain of up to 4 dB in the downlink direction.

**Table 21: AP to AP RF Link Budget, 5.8 GHz: 9 Mbps (-A domain)**

Parameter	Cisco 1552 I/C	Cisco 1552 E/H	Cisco 1522
Tx Power Conducted at 9 Mbps, 20 MHz bandwidth	28 dBm, Composite	26 dBm, Composite	28 dBm
Tx Antenna Cable Loss	0 dB	0.5 dB	0.5 dB

Parameter	Cisco 1552 I/C	Cisco 1552 E/H	Cisco 1522
Tx Antenna Gain	4 dBi (inbuilt antenna)	7 dBi	8 dBi
Tx Beam Forming (BF)	4 dB	4 dB	0 dB
Tx EIRP	36 dBm	36.5 dBm	35.5 dBm
Rx Antenna Gain	4 dBi	7 dBi	8 dBi
Rx Antenna Cable Loss	0 dB	0.5 dB	0.5 dB
Rx Sensitivity	-91 dBm at 9 Mbps	-91 dBm at 9 Mbps	-88 dBm at 9 Mbps
System Gain	131 dB	134 dB	131 dB
Fade Margin	9 dB	9 dB	9 dB
Range between APs (LOS, PLE = 2.3)	829 meters (2722 feet)	1120 meters (3675 feet)	829 meters (2722 feet)

The AP1552 models with built-in antennas (1552C/I) have the same system gain as AP1522s for 5-GHz backhaul giving the AP to AP distance of 2722 feet. A fade margin of 9 dB is assumed, which is inconsistent with the assumption to calculate the required SNR values in the *Wireless Mesh Constraints* section.

#### Link Budget Analysis for AP to Client (–A Domain)

This section contains a link budget analysis for the AP to the Client, so that you know how far away a client can go from the AP with a system gain value in each band. In this analysis, the focus is on the system gain for upstream and downstream. A link should be balanced for upstream and downstream, but it might not happen. Generally, there is a higher antenna gain and higher Tx power available on the AP rather than on the client. But, this can also be opposite in a few regulatory domains because of different EIRP limit requirements. Therefore, the lowest of both upstream and downstream should be taken to calculate the AP to the client distance because that will be the decision factor. For example, if there is a higher downstream gain than upstream, the upstream should be the decision maker for the cell size because the upstream system gain allows only the client to connect to the AP.

The regulatory domain values of Tx EIRP and Rx sensitivities decide whether upstream or downstream has the lower system gain. The cell size should be determined by upstream and not downstream.

Because most of the clients available are 2.4-GHz clients, the focus is on the 2.4-GHz AP to the.

For the AP to client link budget in 2.4 GHz, let us assume a client Tx power of 20 dB and an antenna gain of 0 dBi (see [Table 22: Outdoor 11n AP-to-Client, at 2.4 GHz: 9 Mbps Data Rate \(–A domain\)](#), on page 82). For the –A domain EIRP limit is 36 dBm for 2.4- and 5-GHz bands.

**Table 22: Outdoor 11n AP-to-Client, at 2.4 GHz: 9 Mbps Data Rate (-A domain)**

Parameter	Cisco 1552 I/C		Cisco 1552 E/H		Comments
	DS	US	DS	US	
Tx Power Conducted	28 dBm (AP)	20 dBm (Client)	28 dBm (AP)	20 dBm (Client)	Composite power at 9 Mbps, 20 MHz bandwidth
Tx Antenna Gain	2 dBi (AP)	0 dBi (Client)	4 dBi (AP)	0 dBi (Client)	
Tx Beam Forming (BF)	4 dB (AP)	0 dB (Client)	4 dB (AP)	0 dB (Client)	Legacy Rate ClientLink. Helps only in DS.
Tx EIRP	34 dBm	20 dBm	36 dBm	20 dBm	
Rx Antenna Gain	0 dBi (Client)	2 dBi (AP)	0 dBi (Client)	4 dBi (AP)	
Rx Sensitivity	-90 dBm (Client)	-94 dBm (AP)	-90 dBm (Client)	-94 dBm (AP)	Includes 4.7 dB MRC gain for AP1552
System Gain	124 dB	116 dB	126 dB	118 dB	
Range (AP to Client)		268 meters (881 feet)		323 meters (1058 feet)	LOS, PLE = 2.5

The -A domain AP to client link budget in 2.4 GHz band is limited by upstream. That is, the upstream has lower system gain, and therefore, the decision factor will be upstream.

Cell sizes for AP to Client in 2.4 GHz for different AP1552 models can be decided by picking the lowest of the following two:

- AP to Client distance in the 2.4-GHz band (from [Table 22: Outdoor 11n AP-to-Client, at 2.4 GHz: 9 Mbps Data Rate \(-A domain\)](#), on page 82)
- Half of the distance between AP to AP on the 5-GHz backhaul (from [Table 20: Link Budget Comparison for the 5-GHz band in -A Domain](#), on page 79)

Because most of the clients available are 2.4-GHz clients, we recommend the cell size taking 2.4 GHz values into consideration (see [Table 23: Lowest of AP to Client and Half of AP to AP Backhaul Distance](#), on page 83).

**Table 23: Lowest of AP to Client and Half of AP to AP Backhaul Distance**

AP Type (-A Domain)	AP to Client 2.4 GHz	Half of AP to AP backhaul Distance in 5 GHz
1552 C/I	250 meters (800 feet)	415 meters (1360 feet)
1552 E/H	300 meters (1000 feet)	560 meters (1840 feet)

For the AP to the AP distance, you can take double the AP to the client distance (see [Table 24: Recommendations for Cell Radius](#), on page 83).

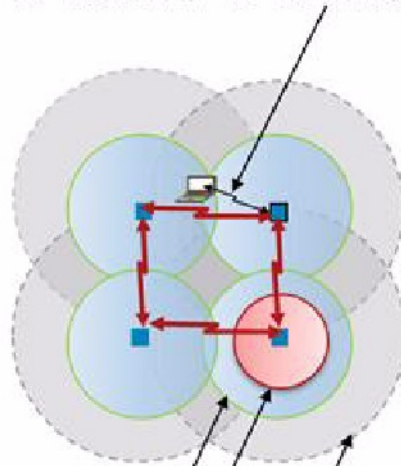
**Table 24: Recommendations for Cell Radius**

AP Type (-A Domain)	AP to Client	AP to AP
1552 C/I	250 meters (800 feet)	500 meters (1600 feet)
1552 E/H	300 meters (1000 feet)	600 meters (2000 feet)

Figure 33: AP-to-Client Cell Radius at 2.4 GHz

### AP-to-Client Cell Radius @ 2.4 GHz

AP 1552C/I: R= 250 meters  
 AP 1552E/H: R= 300 meters



- AP-Client Coverage 2.4 GHz
- AP-Client Coverage 5 GHz
- AP-AP Backhaul Coverage 5 GHz
  - AP-AP Distance  $\geq 2x$  AP-Client Distance

331452

The following assumptions are made:

- Height: APs are at 33 feet (10 meters); Client at 3.3 feet (1 meter)
- Throughput greater than 1 Mbps
- Decreasing AP-to-AP distance improves coverage
- Near LoS. For Less LoS scenarios, you must reduce the distance assumptions
- Flat Terrain Environment

AP Densities result as follows:

- AP1552C and AP1552I: 14 AP/sq. mile = 5.3 AP/sq. km
- AP1552E and AP1552H: 9 AP/sq. mile = 3.5 AP/sq. km

With these recommendations, the likelihood of getting healthy cells is more.





**Note** For 5-GHz clients, the cell radius is comparatively smaller because higher the frequency, higher is the attenuation. The 2.4-GHz band has almost 13 dB better link budget than 5 GHz.

**Comparison of Link Budgets of AP1520 Series and AP1552 Series in 2.4- and 5-GHz Bands (-E Domain)**

In the -E Domain, EIRP limits are comparatively much lower. EIRP limit for 2.4 GHz is 20 dBm and for 5 GHz is 30 dBm.

Let us consider 5 GHz because it is used as a backhaul for mesh. We can take a legacy data rate of 9 Mbps to estimate the range.



**Note** PLE is 2.3 for backhaul.

AP to AP RF Link Budget, 5.6 GHz: 9 Mbps (-E domain)

**Table 25: AP to AP RF Link Budget, 5.6 GHz: 9 Mbps (-E domain)**

Parameter	Cisco 1552 I/C	Cisco 1552 E/H	Cisco 1522
Tx Power Conducted at 9 Mbps, 20 MHz bandwidth	22 dBm, Composite	19 dBm, Composite	22 dBm
Tx Antenna Cable Loss	0 dB	0.5 dB	0.5 dB
Tx Antenna Gain	4 dBi (inbuilt antenna)	7 dBi	8 dBi
Tx Beamforming (BF)	4 dB	4 dB	0 dB
Tx EIRP	30 dBm	30.5 dBm	30.5 dBm
Rx Antenna Gain	4 dBi	7 dBi	8 dBi
Rx Antenna Cable Loss	0 dB	0.5 dB	0.5 dB
Rx Sensitivity	-91 dBm at 9 Mbps	-91 dBm at 9 Mbps	-88 dBm at 9 Mbps
System Gain	125 dB	127 dB	125 dB
Fade Margin	9 dB	9 dB	9 dB
Range between APs (LOS, PLE = 2.3)	471 meters (1543 feet)	575 meters (1888 feet)	471 meters (1543 feet)

The AP1552 models with inbuilt antennas (1552C/I) have the same system gain as AP1522s for 5 GHz backhaul giving the AP to AP distance of 1543 feet.

Link Budget Analysis for AP to Client (-E Domain)

This section contains link budget analysis for AP to Client in the 2.4-GHz band. In this analysis, the focus is on the system gain for upstream and downstream. Ideally, the link should be balanced for upstream and downstream, but practically it may not happen. Therefore, the decision factor for the cell radius will be the lowest of both upstream and downstream.

For AP to client link budget in 2.4 GHz, let us assume a client Tx power of 20 dBm and an antenna gain of 0 dBi.

For -E domain, the EIRP limit is 20 dBm for the 2.4-GHz band and 30 dBm for the 5-GHz band.

**Table 26: Outdoor 11n AP-to-Client, at 2.4 GHz: 9 Mbps Data Rate (-E domain)**

Parameter	Cisco 1552 I/C		Cisco 1552 E/H		Comments
	DS	US	DS	US	
Tx Power Conducted	15 dBm (AP)	20 dBm (Client)	13 dBm (AP)	20 dBm (Client)	Composite power at 9 Mbps, 20 MHz bandwidth
Tx Antenna Gain	2 dBi (AP)	0 dBi (Client)	4 dBi (AP)	0 dBi (Client)	
Tx Beamforming (BF)	3 dB (AP)	0 dB (Client)	3 dB (AP)	0 dB (Client)	Legacy Rate ClientLink. Helps only in DS.
Tx EIRP	20 dBm	20 dBm	20 dBm	20 dBm	
Rx Antenna Gain	0 dBi (Client)	2 dBi (AP)	0 dBi (Client)	4 dBi (AP)	
Rx Sensitivity	-91 dBm (Client)	-94 dBm (AP)	-91 dBm (Client)	-94 dBm (AP)	Includes 4.7 dB MRC gain for AP1552
System Gain	111 dB	116 dB	111 dB	118 dB	
Range (AP to Client)	173 meters (567 feet)		173 meters (567 feet)		LOS, PLE = 2.5 (5 dB fade margin)

The AP to client link budget in the 2.4-GHz band on the -E domain is limited by downstream. Therefore, downstream has a lower system gain. Thus, the decision factor will be downstream.

Cell sizes for AP to Client in 2.4 GHz for different AP1552 models can be decided by picking the lowest of the following two:

- AP to Client distance in 2.4 GHz band (from [Table 26: Outdoor 11n AP-to-Client, at 2.4 GHz: 9 Mbps Data Rate \(-E domain\)](#), on page 86)
- Half of the distance between AP to AP on 5 GHz backhaul (from [Table 25: AP to AP RF Link Budget, 5.6 GHz: 9 Mbps \(-E domain\)](#), on page 85)

Because most of the clients available are 2.4-GHz clients, we recommend the cell size taking 2.4 GHz values into consideration (see [Table 27: Lowest of AP to Client and Half of AP to AP Backhaul Distance](#), on page 87).

**Table 27: Lowest of AP to Client and Half of AP to AP Backhaul Distance**

AP Type (-E Domain)	AP to Client 2.4 GHz	Half of AP to AP backhaul Distance in 5 GHz
1552 C/I	180 meters (600 feet)	235 meters (770 feet)
1552 E/H	180 meters (600 feet)	288 meters (944 feet)

For AP to AP distance we can take double the AP to Client distance (see [Table 28: Recommendations for Cell Radius](#), on page 87).

**Table 28: Recommendations for Cell Radius**

AP Type (-E Domain)	AP to Client	AP to AP
1552 C/I	180 meters (600 feet)	360 meters (1200 feet)
1552 E/H	180 meters (600 feet)	360 meters (1200 feet)



**Note**

To estimate the range and the AP density, you can use range calculators that are available at

- Cisco 1520 Series Outdoor Mesh Range Calculation Utility: [http://www.cisco.com/en/US/products/ps8368/products\\_implementation\\_design\\_guides\\_list.html](http://www.cisco.com/en/US/products/ps8368/products_implementation_design_guides_list.html)
- Range Calculator for 1550 Series Outdoor Mesh Access Points: [http://www.cisco.com/en/US/products/ps11451/products\\_implementation\\_design\\_guides\\_list.html](http://www.cisco.com/en/US/products/ps11451/products_implementation_design_guides_list.html)

## Assumptions for the AP1522 Range Calculator

- The AP1522 Range Calculator has been edited to stay within limitations for Tx power and EIRP under the listed regulatory domains. There may be cases where it exceeds the limitations. You must verify that the installation is within the laws of the location in which it is being installed.
- When you use the AP1522 Range Calculator, available power levels change based upon the regulatory domain, the antenna (or antenna gain) selected, the modulation mode, which is based on the data rate selected (OFDM requires a lower power level in some domains). You must verify all parameters after making any parameter changes.

- Rx sensitivity in 2.4 GHz is the composite sensitivity of all three Rx paths. That is, MRC is included in 2.4 GHz. There is only one Rx for 5 GHz.
- You can choose only the channels that the access point is certified for.
- You can select only valid power levels.

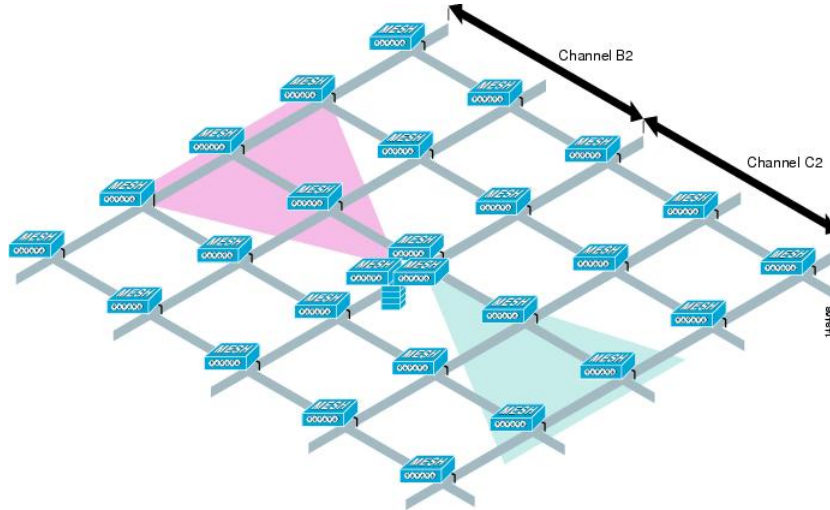
## Assumptions for the AP1552 Range Calculator

- The AP1552 Range Calculator has been edited to stay within limitations for Tx power and EIRP under the listed regulatory domains. There may be cases where it exceeds the limitations. You must verify that the installation is within the laws of the location in which it is being installed.
- All three antenna ports must be used for external antenna models of 1552 for effective performance. Otherwise, range is significantly compromised. 1552 radios have two Tx paths and three Rx paths.
- The Tx power is the total composite power of both Tx paths.
- Rx sensitivity is the composite sensitivity of all three Rx paths. That is, MRC is included.
- The AP1552 Range Calculator assumes that ClientLink (Beamforming) is switched on.
- When you use the AP1552 Range Calculator, available power levels change based upon the regulatory domain, the antenna (or antenna gain) selected, and the data rate selected. You must verify all parameters after making any parameter changes.
- You can select a different antenna than the two that are available by default. If you enter a high gain antenna and choose a power that goes over the EIRP limit, then you get a warning and the range equals 0.
- You can choose only the channels that the access point is certified for.
- You can only select only valid power levels.

The RAPs shown in [Figure 34: PoP with Multiple RAPs, on page 89](#) are simply a starting point. The goal is to use the RAP location in combination with the RF antenna design to ensure that there is a good RF link to the MAP within the core of the cell, which means that the physical location of the RAPs can be on the edge of the cell, and a directional antenna is used to establish a link into the center of the cell. Therefore, the wired

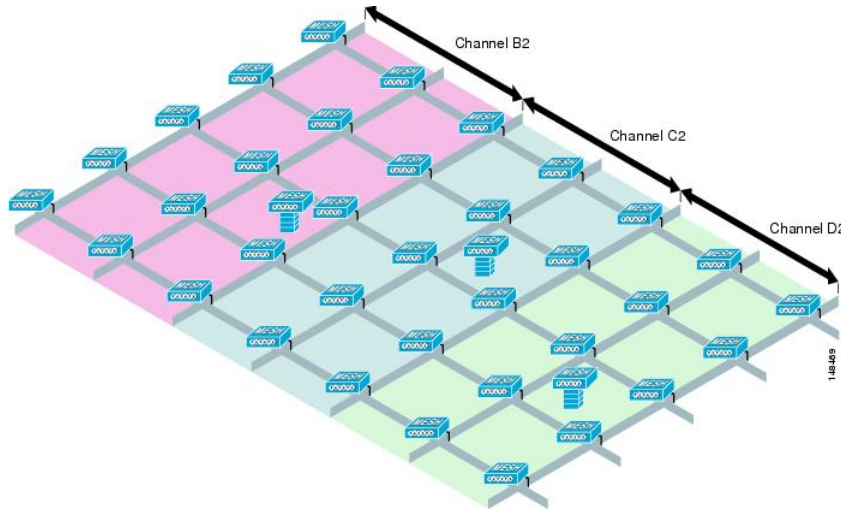
network location of a RAP might play host to the RAP of multiple cells, as shown in [Figure 34: PoP with Multiple RAPs](#), on page 89.

**Figure 34: PoP with Multiple RAPs**



When the basic cell composition is settled, the cell can be replicated to cover a greater area. When replicating the cells, a decision needs to be made whether to use the same backhaul channel on all cells or to change backhaul channels with each cell. In the example shown in [Figure 35: Multiple RAP and MAP Cells](#), on page 89, various backhaul channels (B2, C2, and D2) per cell have been chosen to reduce the co-channel interference between cells.

**Figure 35: Multiple RAP and MAP Cells**

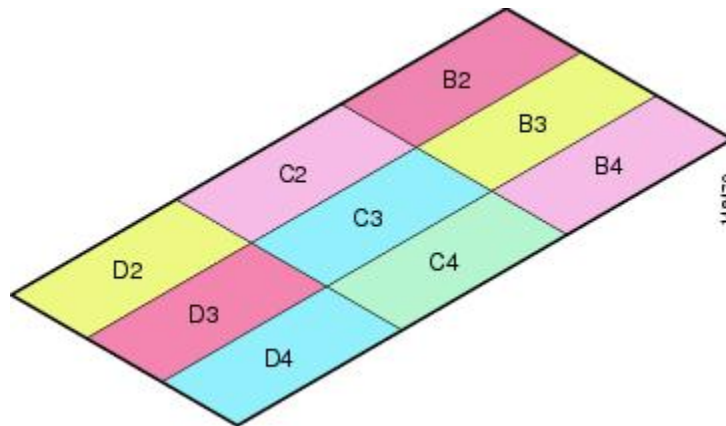


Choosing various channels reduces the co-channel interference at the cell boundaries, at the expense of faster mesh convergence, because MAPs must fall back to seek mode to find neighbors in adjacent cells. In areas of high-traffic density, co-channel interference has the highest impact, which is likely to be around the RAP.

If RAPs are clustered in one location, a different channel strategy is likely to give optimal performance; if RAPs are dispersed among the cells, using the same channel is less likely to degrade performance.

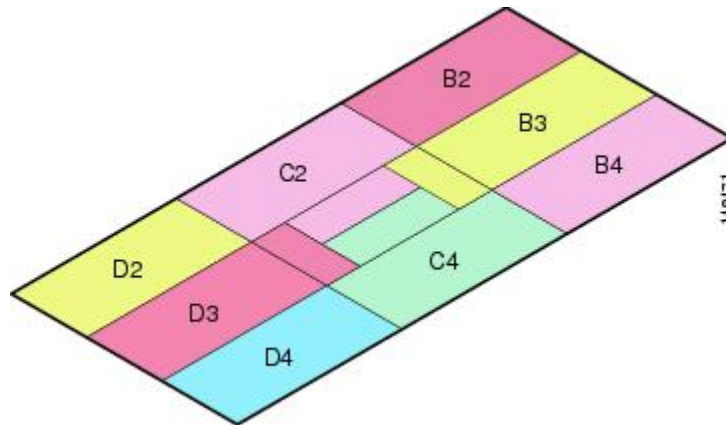
When you lay out multiple cells, use channel planning similar to standard WLAN planning to avoid overlapping channels, as shown in [Figure 36: Laying out Various Cells](#), on page 90.

**Figure 36: Laying out Various Cells**



If possible, the channel planning should also minimize channel overlap in cases where the mesh has expanded to cover the loss of a RAP connection, as shown in [Figure 37: Failover Coverage](#), on page 90.

**Figure 37: Failover Coverage**



## Collocating Mesh Access Points

The following recommendations provide guidelines to determine the required antenna separation when you collocate AP1500s on the same tower. The recommended minimum separations for antennas, transmit powers, and channel spacing are addressed.

The goal of proper spacing and antenna selection is to provide sufficient isolation by way of antenna radiation pattern, free space path loss, and adjacent or alternate adjacent channel receiver rejection to provide independent operation of the collocated units. The goal is to have negligible throughput degradation due to a CCA hold-off, and negligible receive sensitivity degradation due to a receive noise floor increase.

You must follow antenna proximity requirements, which depend upon the adjacent and alternate adjacent channel usage.

### Collocating AP1500s on Adjacent Channels

If two collocated AP1500s operate on adjacent channels such as channel 149 (5745 MHz) and channel 152 (5765 MHz), the minimum vertical separation between the two AP1500s is 40 feet (12.192 meters) (the requirement applies for mesh access points equipped with either 8 dBi omnidirectional or 17 dBi high-gain directional patch antennas).

If two collocated AP1500s operate on channels 1, 6, or 11 (2412 to 2437 MHz) with a 5.5-dBi omnidirectional antenna, then the minimum vertical separation is 8 feet (2.438 meters).

### Collocating AP1500s on Alternate Adjacent Channels

If two collocated AP1500s operate on alternate adjacent channels such as channel 149 (5745 MHz) and channel 157 (5785 MHz), the minimum vertical separation between the two AP1500s is 10 feet (3.048 meters) (the requirements applies for mesh access points equipped with either 8-dBi omnidirectional or 17-dBi high-gain directional patch antennas).

If two collocated AP1500s operate on alternate adjacent channels 1 and 11 (2412 MHz and 2462 MHz) with a 5.5-dBi omnidirectional antenna, then the minimum vertical separation is 2 feet (0.609 meters).

In summary, a 5-GHz antenna isolation determines mesh access point spacing requirements and antenna proximity must be followed and is dependent upon the adjacent and alternate adjacent channel usage.

## Special Considerations for Indoor Mesh Networks

Note these considerations for indoor mesh networks:

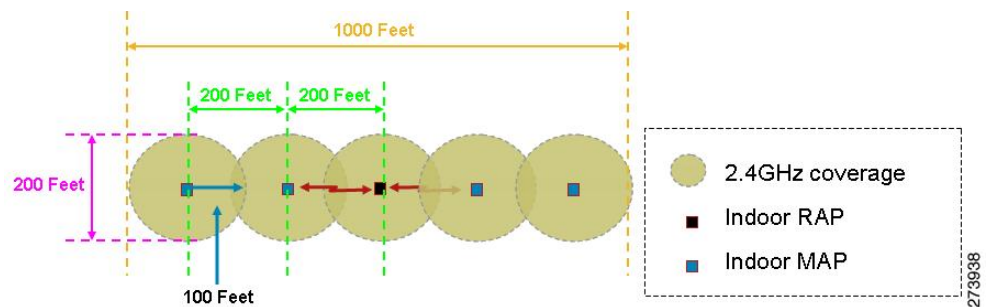
- For outdoors, voice is supported on a best-effort basis on a mesh infrastructure.
- Quality of Service (QoS) is supported on the local 2.4-GHz client access radio and on the 5-GHz and 4.9-GHz backhails.
- Cisco also supports static Call Admission Control (CAC) in CCXv4 clients, which provides CAC between the access point and the client.
- RAP-to-MAP ratio—The recommended ratio is 3 to 4 MAPs per RAP.
- AP-to-AP distance:
  - For non-11n mesh APs (1130 and 1240), a spacing of no more than of 200 feet (60.96 meters) between each mesh access point is recommended with a cell radius of 100 feet (30.48 meters).
  - For 11n mesh APs(1040, 1140, 1250, 1260, 3500e and 3500i), a spacing of no more than 250 feet between each mesh AP with a cell radius of 125 feet is recommended.
- Hop count—For data, the maximum is 4 hops. No more than 2 hops is recommended for voice.
- RF considerations for client access on voice networks:
  - Coverage hole of 2 to 10 percent
  - Cell coverage overlap of 15 to 20 percent
  - Voice needs RSSI and SNR values that are at least 15 dB higher than data requirements

- RSSI of -67 dBm for all data rates should be the goal for 11b/g/n and 11a/n
- SNR should be 25 dB for the data rate used by client to connect to the AP
- Packet error rate (PER) should be configured for a value of one percent or less
- Channel with the lowest utilization (CU) must be used

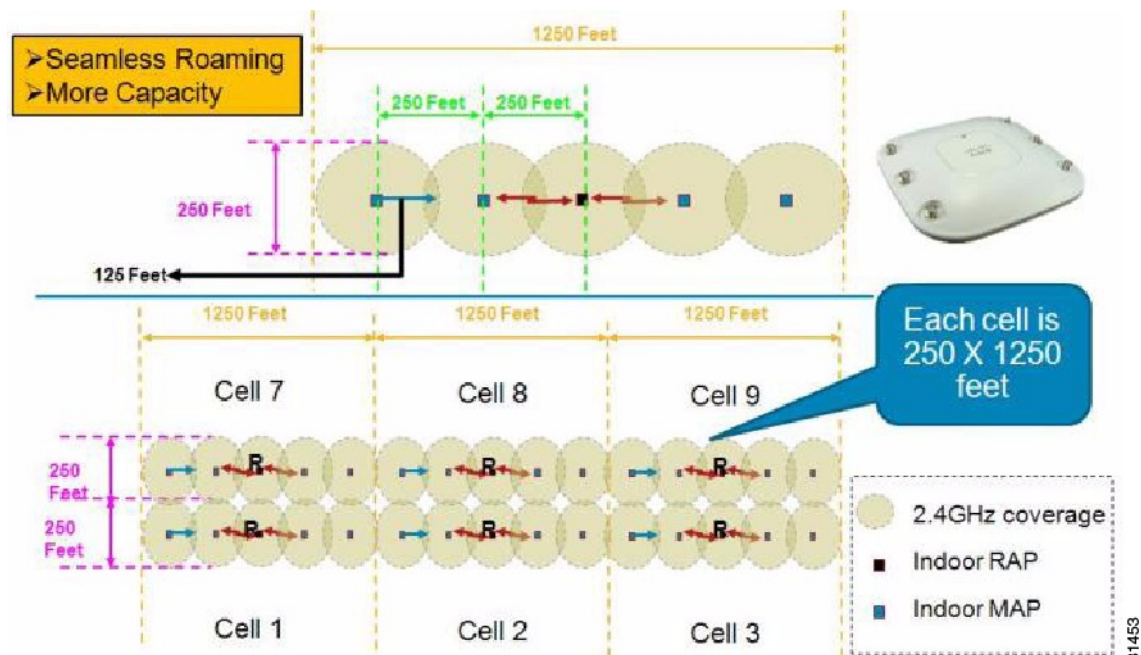
Check the CU when no traffic is running

- Radio resource manager (RRM) can be used to implement the recommended RSSI, PER, SNR, CU, cell coverage, and coverage hole settings on the 802.11b/g/n radio (RRM is not available on 802.11a/n radio).

**Figure 38: Cell Radius of 100 Feet (30.4 meters) and Access Point Placement for Voice Mesh Networks**



**Figure 39: Cell Radius of 125 Feet (38 meters) and Access Point Placement for Indoor 11n Mesh Networks**





**Note**

Although you can use directional antenna and have an AP-to-AP distance longer than 250 feet (76.2 meters), for seamless roaming, we recommend that you have an AP-to-AP distance no more than 250 feet.

## Wireless Propagation Characteristics

[Table 29: Comparison of 2.4-GHz and 5-GHz Bands, on page 93](#) provides a comparison of the 2.4-GHz and 5-GHz bands.

The 2.4-GHz band provides better propagation characteristics than 5 GHz, but 2.4 GHz is an unlicensed band and has historically been affected with more noise and interference to date than the 5-GHz band. In addition, because there are only three backhaul channels in 2.4 GHz, co-channel interference would result. Therefore, the best method to achieve comparable capacity is by reducing system gain (that is, transmit power, antenna gain, receive sensitivity, and path loss) to create smaller cells. These smaller cells require more access points per square mile (greater access point density).

**Table 29: Comparison of 2.4-GHz and 5-GHz Bands**

2.4-GHz Band Characteristics	5-GHz Band Characteristics
3 channels	20 channels
More prone to co-channel interference	No co-channel interference
Lower power	Higher power
Lower SNR requirements given lower data rates	Higher SNR requirements given higher data rates
Better propagation characteristics than 5 GHz but more susceptible to noise and interference	Worse propagation characteristics than 2.4 GHz but less susceptible to noise and interference
Unlicensed band. Widely available throughout the world.	Not as widely available in the world as 2.4-GHz. Licenses in some countries.

2.4 GHz has more penetration capability across the obstacles due to a larger wavelength. In addition, 2.4 GHz has lower data rates which increases the success of the signal to reach the other end.

## CleanAir

The 1550 series leverages 802.11n technology with integrated radio and internal/external antennas. The 1550 series access points are based on the same chipset as the present CleanAir capable Aironet 3500 APs. In other words, the 1550 series access points are capable of doing CleanAir.

With the 7.3.101.0 release, 2600 series access points can mesh with each other and can also provide CleanAir functionality.

With the 7.2.103.0 release, 3600 series access points can mesh with each other and can also provide CleanAir functionality.

With the 7.0.116.0 release, 3500 series access points can mesh with each other and can also provide CleanAir functionality.

CleanAir in mesh (1552, 3500 and 3600) can be implemented on the 2.4-GHz radio and provides clients complete 802.11n data rates while detecting, locating, classifying, and mitigating radio frequency (RF) interference. This provides a carrier class management and customer experience and ensures that you have control over the spectrum in the deployed location. CleanAir enabled RRM technology on the outdoor 11n platform detects, quantifies, and mitigates Wi-Fi and non-Wi-Fi interference on 2.4-GHz radios. AP1552 supports CleanAir in 2.4 GHz client access mode. AP3500/AP3600 in bridge (mesh) mode also supports CleanAir in 2.4 GHz client access only and not on the backhaul.

## CleanAir AP Modes of Operation

Bridge (Mesh) Mode AP (recommended)—AP1552 in bridge mode (mesh) offers complete CleanAir functionality in the 2.4-GHz band. Bridge (mesh) mode is equivalent of Local Mode (LMAP) for nonmesh CleanAir access points as far as CleanAir functionality is concerned. AP1552 comes only in the Bridge mode and the mode cannot be changed. A mesh access point performs CleanAir function and also serves clients on the assigned channel similar to the way the Cisco Indoor CleanAir AP3500 (nonmesh mode) operating in LMAP mode serving clients on its assigned channel. The mesh AP also monitors the spectrum only on that channel.

Similar CleanAir functionality is applicable to AP3500 in mesh mode. When AP3500 is in nonmesh mode, the AP can perform CleanAir function in LMAP or Monitor Mode. When AP3500 is in mesh mode, the AP can perform CleanAir function in bridge (mesh) mode on 2.4 GHz, serving clients at the same time on the assigned channel.

Tight silicon integration with the Wi-Fi radio allows the CleanAir hardware to listen between traffic on the channel that is currently being served with no penalty to throughput of attached clients. That is, line rate detection without interrupting client traffic.

AP1552 in 2.4 GHz client access offers Radio Resource Management (RRM) which helps to mitigate the interference from WiFi interferers. RRM is not available for the 5 GHz backhaul. There are no CleanAir dwells processed during normal off channel scans. Normally, a CUWN Local Mode AP executes an off channel passive scan of the alternate available channels in 2.4 GHz. Off-channel scans are used for system maintenance such as RRM metrics and rogue detection. The frequency of these scans is not sufficient to collect back-to-back dwells required for positive device classification. Thus, information collected during this scan is suppressed by the system. Increasing the frequency of off-channel scans is also not desirable because it takes away the time that the radio services traffic.

A CleanAir Mesh AP only scans one channel of each band continuously. In a normal deployment density, there should be many access points on the same channel, and at least one on each channel, assuming RRM is handling channel selection. In 2.4 GHz, access points have sufficient density to ensure at least three points of classification. An interference source that uses narrow band modulation (operates on or around a single frequency) is only detected by access points that share the frequency space. If the interference is a frequency hopping type (uses multiple frequencies—generally covering the whole band), it is detected by every access point that can hear it operating in the band.

Monitor Mode AP (optional) (MMAp)—A CleanAir monitor mode AP is dedicated and does not serve client traffic. The monitor mode ensures that all bands-channels are routinely scanned. The monitor mode is not available for AP1552, 3500 and 3600 in bridge (mesh) mode because in a mesh environment, access points also talk to each other on the backhaul. If a mesh AP (MAP) is in the monitor mode, then it cannot perform

mesh operation. Also, it is not possible for AP1552 or AP3500 (bridge mode) to be in a dedicated monitor mode.

Spectrum Expert Connect Mode (optional) (SE Connect)—An SE Connect AP is configured as a dedicated spectrum sensor that allows connection of the Cisco Spectrum Expert application running on a local host to use the CleanAir AP as a remote spectrum sensor for the local application. This mode allows viewing of the raw spectrum data such as FFT plots and detailed measurements. This mode is intended for only remote troubleshooting.

**Note**

---

SE Connect mode is not available in AP1552, 3500 and 3600 in bridge (mesh) mode.

---

## Pseudo MAC (PMAC) and Merging

PMAC and Merging phenomenon is similar to the one for Generation 2 access points in local mode. A PMAC is calculated as part of the device classification and included in the interference device record (IDR). Each AP generates the PMAC independently. While it is not identical for each report (at a minimum the measured RSSI of the device is likely different at each AP), it is similar. The function of comparing and evaluating PMACs is called merging. The PMAC is not exposed to customer interfaces. Only the results of merging are available in the form of a cluster ID.

The same device can be detected by multiple APs. All the PMACs and IDRs are analyzed on the controller and a report is generated called a device cluster, which shows the APs detecting the device and the device cluster showing the AP which is hearing the device as strongest.

In this merging spatial proximity, RF proximity (RF neighbor relationship) work together. If there are six similar IDRs with 5 APs nearby and another one from an AP that is far away, it is unlikely that it is the same interferer. Therefore, a cluster is formed taking all these into account. MSE and the controller first rely on RF Neighbor lists to establish spatial proximity in a merge.

PMAC Convergence and Merging depends upon the following factors:

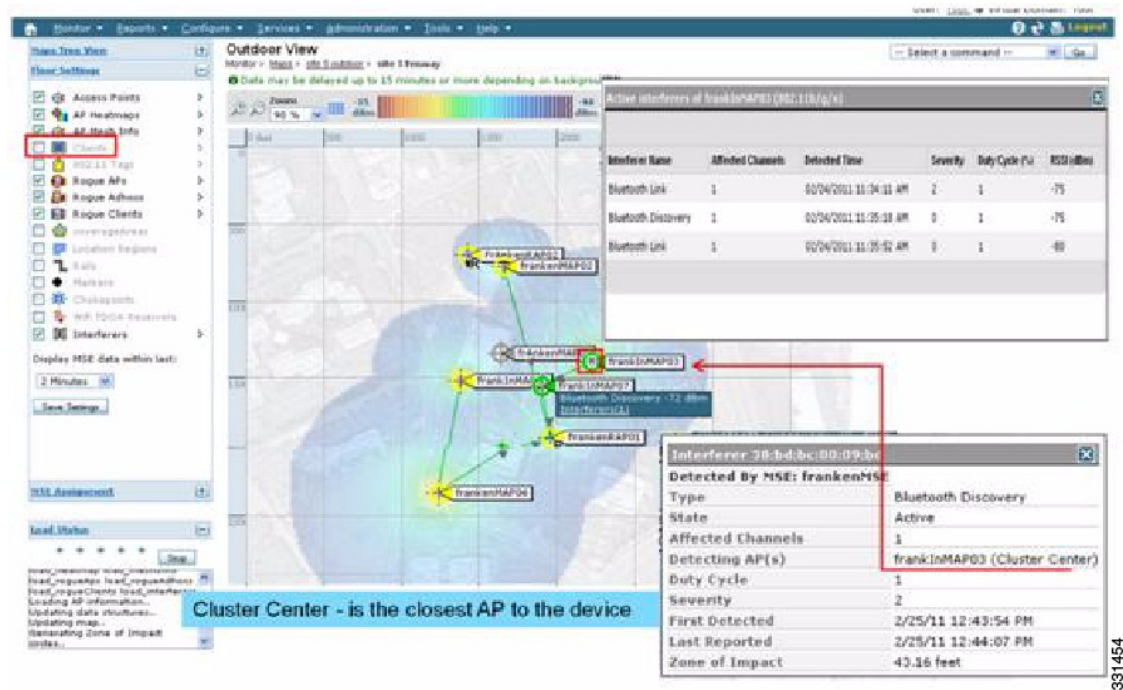
- Density of the sensors
- Quality of the observed classification
- RSSI from the interferer to the APs
- RF neighbor list at the APs

So RRM on 2.4 GHz in mesh also plays a key role in deciding the merging aspect. APs should be RF neighbors for any possibility of Merging. RF Neighbor list is consulted and spatial relationships for IDRs are taken into account for Merging.

Because there is no Monitor Mode in mesh, a single controller merging occurs on the controller. The result of a controller merge is forwarded to the MSE (if present) along with all of the supporting IDRs.

For more than one WLC (possible in outdoor deployments), merging occurs on the MSE. MSE does more advanced merging and extracts location and historical information for interferers. No Location is performed on controller merged interferers. Location is done on the MSE.

**Figure 40: Pseudo MAC Merging in Outdoors**



After PMAC signature merging, you can identify which AP can hear the device, and which AP is the center of a cluster. In the figure above, the values are relevant to the band selected. The label R on AP indicates that the AP is a RAP and the line between APs shows the mesh relationship.

## Event Driven Radio Resource Management and Persistence Device Avoidance

There are two key mitigation features that are present with CleanAir. Both rely directly on information that can only be gathered by CleanAir. Event Driven Radio Resource Management (EDRRM) and Persistence Device Avoidance (PDA). For mesh networks, they work exactly the same way as for nonmesh networks in the 2.4-GHz band.



### Note

EDRRM and PDA are only available in a Greenfield installation and configured off by default.

## CleanAir Access Point Deployment Recommendations

CleanAir is a passive technology that does not affect the normal operation of Wi-Fi networks. There is no inherent difference between a CleanAir deployment and a mesh deployment.

Locating a non-Wi-Fi device has a lot of variables to consider. Accuracy increases with power, duty cycle, and the number of channels hearing the device. This is advantageous because higher power, higher duty cycle, and devices that impact multiple channels are considered to be severe with respect to interference to networks.



**Note** There is no guarantee of accuracy for location of non- Wi-Fi devices.

There are a lot of variables in the world of consumer electronics and unintentional electrical interference. Any expectation of accuracy that is derived from current Client or Tag location accuracy models does not apply to non-Wi-Fi location and CleanAir features.

Important notes to consider:

- CleanAir mesh AP supports the assigned channel only.
- Band Coverage is implemented by ensuring that channels are covered.
- The CleanAir mesh AP can hear very well, and the active cell boundary is not the limit.
- For Location solutions, the RSSI cutoff value is  $-75$  dBm.
- A minimum of three quality measurements is required for location resolution.

In most deployments, it is difficult to have a coverage area that does not have at least three APs nearby on the same channel in the 2.4-GHz band. In locations where there is minimal density, while the location resolution is likely not supported, the active user channel is protected.

Deployment considerations are dependent upon planning the network for desired capacity and ensuring that you have the correct components and network paths in place to support CleanAir functions. RF proximity and the importance of RF Neighbor Relations cannot be understated. It is important to keep in mind the PMAC and the merging process. If a network does not have a good RF design, the neighbor relations is affected, which in turn affects CleanAir performance.

The AP Density recommendations for CleanAir remain the same as normal mesh AP deployment.

Location resolution in the Outdoors is to the nearest AP. Devices are located near the AP which is physically closest to the device. It is advisable to assume closest AP resolution.

It is possible to deploy a few 1520 APs (non-CleanAir) with an installation that consists of 1552 APs (CleanAir). This deployment can work from a client and coverage standpoint as these access points are fully interoperable with each other. The complete CleanAir functionality depends on all access points being CleanAir enabled. Detection can be affected, and mitigation is not recommended.

A CleanAir AP actively serving clients can only monitor the assigned channel that it is serving. In an area where you have multiple access points serving clients in close proximity, the channels being served by CleanAir access points can drive CleanAir features. Legacy non-CleanAir access points rely on RRM, and mitigate interference issues, but not report the type and severity as CleanAir access points do to the system level.

For more information about mixed systems, see [http://www.cisco.com/en/US/products/ps10315/products\\_tech\\_note09186a0080b4bdc1.shtml](http://www.cisco.com/en/US/products/ps10315/products_tech_note09186a0080b4bdc1.shtml)

## CleanAir Advisor

If CleanAir is enabled on a backhaul radio, CleanAir Advisor is activated. CleanAir Advisor generates Air Quality Index (AQI) and Interferer Detection Reports (IDR) but the reports are only displayed in the controller. No action is taken through event driven RRM (ED-RRM). CleanAir Advisor is only present on the 5-GHz

backhaul radio of the 1552 access points in Bridge mode. In all other AP modes, the 5-GHz backhaul radio of the 1552 access points operates in CleanAir mode.

## Enabling CleanAir

To enable CleanAir functionality in the system, you first need to enable CleanAir on the controller through **Wireless > 802.11a/b > CleanAir**. Although CleanAir is disabled by default, CleanAir is enabled by default on the AP interface.

After you enable CleanAir, it takes 15 minutes to propagate air quality information because the default reporting interval is 15 minutes. However, you can see the results instantly at the CleanAir detail level on the radio by going to **Monitor > Access Points > 802.11a/n or 802.11b/n**.

## Licensing

A CleanAir system requires a CleanAir AP and a controller that is running release 7.0 or later releases. Adding the Cisco Prime Infrastructure allows the displays to be enhanced and additional information to be correlated within the system. Adding the MSE further enhances the available features and provides the history and location of specific interference devices. There is no additional license requirement for the CleanAir feature because the CleanAir AP is the license. Adding the Prime Infrastructure can be done with a basic license. Adding the MSE to the system requires a Prime Infrastructure Plus license and a context-aware license selection for the MSE.

For purposes of interference location with the MSE, each interference device counts as a location target in Context-Aware. One hundred Permanent Interferer licenses are embedded in the MSE. Interferer Licenses open as CleanAir APs are detected, in stages of five licenses per CleanAir AP. This process is applicable to AP1552. An Interference device is the same as a client or a tag from a license quantity standpoint. Only a small percentage of the available licenses are used because there should be far less interference devices than clients or tags to track. Users do have control over what types of interference devices to detect and located from the controller configuration menus.

Cisco context-aware licenses can be managed and limited by the class of target (client, tag, interference), which gives users complete control over how licenses are used.



---

**Note** Each interference device requires one context-aware service (CAS) license.

---

If you have too many Bluetooth devices, it is advisable to switch off the tracing of these devices because they might take up too many CAS licenses.

## Wireless Mesh Mobility Groups

A mobility group allows controllers to peer with each other to support seamless roaming across controller boundaries. APs learn the IP addresses of the other members of the mobility group after the CAPWAP Join process. A controller can be a member of a single mobility group which can contain up to 24 controllers. Mobility is supported across 72 controllers. There can be up to 72 members (WLCs) in the mobility list with up to 24 members in the same mobility group (or domain) participating in client hand-offs. The IP address of a client does not have to be renewed in the same mobility domain. Renewing the IP address is irrelevant in the controller-based architecture when you use this feature.

## Multiple Controllers

The consideration in distance of the CAPWAP controllers from other CAPWAP controllers in the mobility group, and the distance of the CAPWAP controllers from the RAP, is similar to the consideration of an CAPWAP WLAN deployment in an enterprise.

There are operational advantages to centralizing CAPWAP controllers, and these advantages need to be traded off against the speed and capacity of the links to the CAPWAP APs and the traffic profile of the WLAN clients using these mesh access points.

If the WLAN client traffic is expected to be focused on particular sites, such as the Internet or a data center, centralizing the controllers at the same sites as these traffic focal points gives the operational advantages without sacrificing traffic efficiency.

If the WLAN client traffic is more peer-to-peer, a distributed controller model might be a better fit. It is likely that a majority of the WLAN traffic are clients in the area, with a smaller amount of traffic going to other locations. Given that many peer-to-peer applications can be sensitive to delay and packet loss, you should ensure that traffic between peers takes the most efficient path.

Given that most deployments see a mix of client-server traffic and peer-to-peer traffic, it is likely that a hybrid model of CAPWAP controller placement is used, where points of presence (PoPs) are created with clusters of controllers placed in strategic locations in the network.

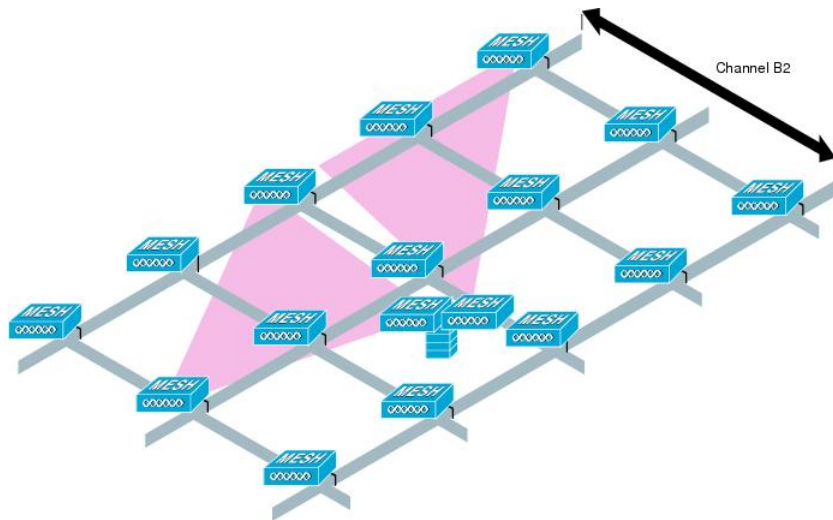
The CAPWAP model used in the wireless mesh network is designed for campus networks; that is, it expects a high-speed, low-latency network between the CAPWAP mesh access points and the CAPWAP controller.

## Increasing Mesh Availability

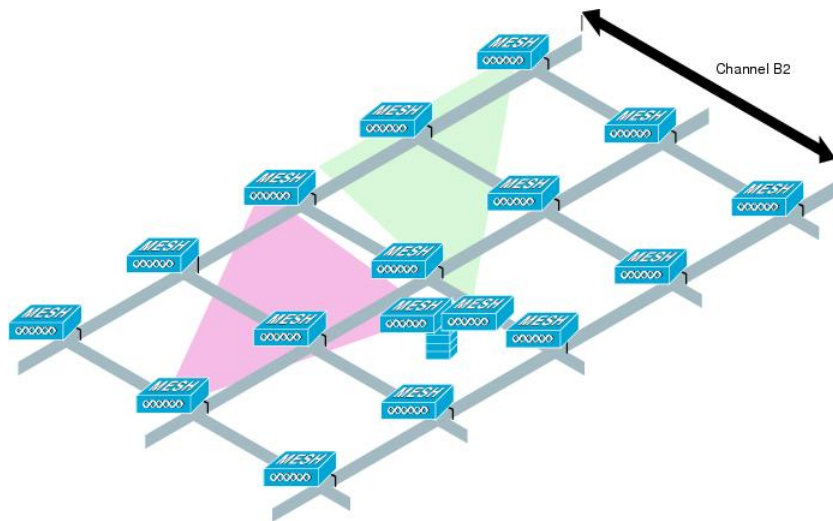
In the Cell Planning Distance section, a wireless mesh cell of one square mile was created and then built upon. This wireless mesh cell has similar properties to the cells used to create a cellular phone network because the smaller cells (rather than the defined maximum cell size) can be created to cover the same physical area, providing greater availability or capacity. This process is done by adding a RAP to the cell. Similar to the larger mesh deployment, the decision is whether to use RAP on the same channel, as shown in [Figure 41: Two RAPs per Cell with the Same Channel](#), on page 100, or to use RAPs placed on different channels, as

shown in [Figure 42: Two RAPs per Cell on Different Channels](#), on page 100. The addition of RAPs into an area adds capacity and resilience to that area.

**Figure 41: Two RAPs per Cell with the Same Channel**



**Figure 42: Two RAPs per Cell on Different Channels**



## Multiple RAPs

If multiple RAPs are to be deployed, the purpose for deploying these RAPs needs to be considered. If the RAPs are being deployed to provide hardware diversity, the additional RAP(s) should be deployed on the same channel as the primary RAP to minimize the convergence time in a scenario where the mesh transfers from one RAP to another. When you plan RAP hardware diversity, consider the 32 MAPs per RAP limitation.



If additional RAPs are deployed to primarily provide additional capacity, then the additional RAPs should be deployed on a different channel than its neighboring RAP to minimize the interference on the backhaul channels.

Adding a second RAP on a different channel also reduces the collision domain through channel planning or through RAP cell splitting. Channel planning allocates different nonoverlapping channels to mesh nodes in the same collision domain to minimize the collision probability. RAP cell splitting is a simple, yet effective, way to reduce the collision domain. Instead of deploying one RAP with omnidirectional antennas in a mesh network, two or more RAPs with directional antennas can be deployed. These RAPs collocate with each other and operate on different frequency channels. This process divides a large collision domain into several smaller ones that operate independently.

If the mesh access point bridging features are being used with multiple RAPs, these RAPs should all be on the same subnet to ensure that a consistent subnet is provided for bridge clients.

If you build your mesh with multiple RAPs on different subnets, MAP convergence times increase if a MAP has to fail over to another RAP on a different subnet. One way to limit this process from happening is to use different BGNs for segments in your network that are separated by subnet boundaries.

## Indoor Mesh Interoperability with Outdoor Mesh

Complete interoperability of indoor mesh access points with the outdoor ones is supported. It helps to bring coverage from outdoors to indoors. We recommend indoor mesh access points for indoor use only, and these access points should be deployed outdoors only under limited circumstances as described below.



### Caution

---

The indoor access points in a third-party outdoor enclosure can be deployed for limited outdoor deployments, such as a simple short haul extension from an indoor WLAN to a hop in a parking lot. The 1240, 1250, 1260, 1600, 2600, 3500e, and 3600 access points in an outdoor enclosure is recommended because of its robust environmental and temperature specifications. Additionally, the indoor access points have connectors to support articulated antennas when the AP is within an outdoor enclosure. Exercise caution with the SNR values as they may not scale and long-term fades may take away the links for these APs when compared to a more optimized outdoor 1500 series access point.

---

Mobility groups can be shared between outdoor mesh networks and indoor WLAN networks. It is also possible for a single controller to control indoor and outdoor mesh access points simultaneously. The same WLANs are broadcast out of both indoor and outdoor mesh access points.



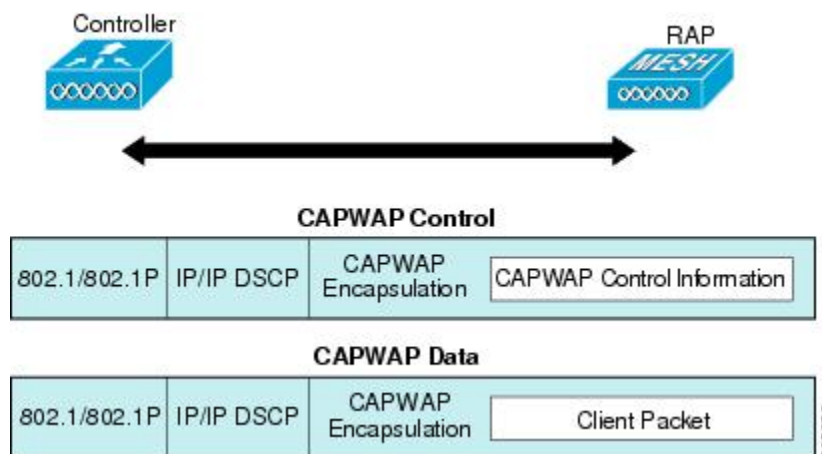


# Connecting the Cisco 1500 Series Mesh Access Points to the Network

This chapter describes how to connect the Cisco 1500 Series mesh access points to the network.

The wireless mesh terminates on two points on the wired network. The first location is where the RAP attaches to the wired network, and where all bridged traffic connects to the wired network. The second location is where the CAPWAP controller connects to the wired network; this location is where the WLAN client traffic from the mesh network connects to the wired network (see [Figure 43: Mesh Network Traffic Termination](#), on page 103). The WLAN client traffic from CAPWAP is tunneled at Layer 2, and matching WLANs should terminate on the same switch VLAN where the controllers are collocated. The security and network configuration for each of the WLANs on the mesh depend on the security capabilities of the network to which the controller is connected.

**Figure 43: Mesh Network Traffic Termination**



**Note**

When an HSRP configuration is in operation on a mesh network, we recommend that the In-Out multicast mode be configured. For more details on multicast configuration, see the Enabling Multicast on the Network (CLI) section.

For more information about upgrading to a new controller software release, see the *Release Notes for Cisco Wireless LAN Controllers and Lightweight Access Points* at [http://www.cisco.com/en/US/products/ps10315/prod\\_release\\_notes\\_list.html](http://www.cisco.com/en/US/products/ps10315/prod_release_notes_list.html).

For more information about mesh and controller software releases and the compatible access points, see the *Cisco Wireless Solutions Software Compatibility Matrix* at [http://www.cisco.com/en/US/docs/wireless/controller/5500/tech\\_notes/Wireless\\_Software\\_Compatibility\\_Matrix.html](http://www.cisco.com/en/US/docs/wireless/controller/5500/tech_notes/Wireless_Software_Compatibility_Matrix.html).

This chapter contains the following sections:

- [Adding Mesh Access Points to the Mesh Network](#), page 104
- [Configuring Advanced Features](#), page 153

## Adding Mesh Access Points to the Mesh Network

This section assumes that the controller is already active in the network and is operating in Layer 3 mode.




---

**Note** Controller ports that the mesh access points connect to should be untagged.

---

Before adding a mesh access point to a network, do the following:

- 
- Step 1** Add the MAC address of the mesh access point to the controller's MAC filter. See the *Adding MAC Addresses of Mesh Access Points to MAC Filter* section.
  - Step 2** Define the role (RAP or MAP) for the mesh access point. See the *Defining Mesh Access Point Role* section.
  - Step 3** Verify that Layer 3 is configured on the controller. See the *Verifying Layer 3 Configuration* section.
  - Step 4** Configure a primary, secondary, and tertiary controller for each mesh access point. See the *Configuring Multiple Controllers Using DHCP 43 and DHCP 60* section.  
Configure a backup controller. See the *Configuring Backup Controllers* section.
  - Step 5** Configure external authentication of MAC addresses using an external RADIUS server. See the *Configuring External Authentication and Authorization Using a RADIUS Server*.
  - Step 6** Configure global mesh parameters. See the *Configuring Global Mesh Parameters* section.
  - Step 7** Configure backhaul client access. See the *Configuring Advanced Features* section.
  - Step 8** Configure local mesh parameters. See the *Configuring Local Mesh Parameters* section.
  - Step 9** Configure antenna parameters. See the *Configuring Antenna Gain* section.
  - Step 10** Configure channels for serial backhaul. This step is applicable only to serial backhaul access points. See the *Backhaul Channel Deselection on Serial Backhaul Access Point* section.
  - Step 11** Configure the DCA channels for the mesh access points. See the *Configuring Dynamic Channel Assignment* section.
  - Step 12** Configure mobility groups (if desired) and assign controllers. See the *Configuring Mobility Groups* chapter in the *Cisco Wireless LAN Controller Configuration Guide*.
  - Step 13** Configure Ethernet bridging (if desired). See the *Configuring Ethernet Bridging* section.
  - Step 14** Configure advanced features such as Ethernet VLAN tagging network, video, and voice. See the *Configuring Advanced Features* section.
-

## Adding MAC Addresses of Mesh Access Points to MAC Filter

You must enter the radio MAC address for all mesh access points that you want to use in the mesh network into the appropriate controller. A controller only responds to discovery requests from outdoor radios that appear in its authorization list. MAC filtering is enabled by default on the controller, so only the MAC addresses need to be configured. If the access point has an SSC and has been added to the AP Authorization List, then the MAC address of the AP does not need to be added to the MAC Filtering List.

You can add the mesh access point using either the GUI or the CLI.



### Note

You can also download the list of mesh access point MAC addresses and push them to the controller using Cisco Prime Infrastructure.

### Adding the MAC Address of the Mesh Access Point to the Controller Filter List (GUI)

To add a MAC filter entry for the mesh access point on the controller using the controller GUI, follow these steps:

**Step 1** Choose **Security > AAA > MAC Filtering**. The MAC Filtering page appears.

**Figure 44: MAC Filtering Page**

MAC Address	Profile Name	Interface	Description
001d713e78b00	Any WLAN	management	SB_MAP2
001d713e78e00	Any WLAN	management	SB_MAP3
001d713e78900	Any WLAN	management	SB_MAP1
001d713e78d00	Any WLAN	management	SB_RAP1

**Step 2** Click **New**. The MAC Filters > New page appears.

**Step 3** Enter the radio MAC address of the mesh access point.

**Note** For 1500 series outdoor mesh access points, specify the BVI MAC address of the mesh access point into the controller as a MAC filter. For indoor mesh access points, enter the Ethernet MAC. If the required MAC address does not appear on the exterior of the mesh access point, enter the following command at the access point console to display the BVI and Ethernet MAC addresses: **sh int | i hardware**.

**Step 4** From the Profile Name drop-down list, select **Any WLAN**.

**Step 5** In the Description field, specify a description of the mesh access point. The text that you enter identifies the mesh access point on the controller.

**Note** You might want to include an abbreviation of its name and the last few digits of the MAC address, such as ap1522:62:39:10. You can also note details on its location such as *roof top*, *pole top*, or its cross streets.

**Step 6** From the Interface Name drop-down list, choose the controller interface to which the mesh access point is to connect.

**Step 7** Click **Apply** to commit your changes. The mesh access point now appears in the list of MAC filters on the MAC Filtering page.

**Step 8** Click **Save Configuration** to save your changes.

**Step 9** Repeat this procedure to add the MAC addresses of additional mesh access points to the list.

## Adding the MAC Address of the Mesh Access Point to the Controller Filter List (CLI)

To add a MAC filter entry for the mesh access point on the controller using the controller CLI, follow these steps:

**Step 1** To add the MAC address of the mesh access point to the controller filter list, enter this command:

```
config macfilter add ap_mac wlan_id interface [description]
```

A value of zero (0) for the *wlan\_id* parameter specifies any WLAN, and a value of zero (0) for the *interface* parameter specifies none. You can enter up to 32 characters for the optional *description* parameter.

**Step 2** To save your changes, enter this command:

```
save config
```

## Defining Mesh Access Point Role

By default, AP1500s are shipped with a radio role set to MAP. You must reconfigure a mesh access point to act as a RAP.

### General Notes about MAP and RAP Association With The Controller

The general notes are as follows:

- A MAP always sets the Ethernet port as the *primary backhaul* if it is UP, and secondarily the 802.11a/n radio. This gives the network administrator time to reconfigure the mesh access point as a RAP, initially.

For faster convergence on the network, we recommend that you do not connect any Ethernet device to the MAP until it has joined the mesh network.

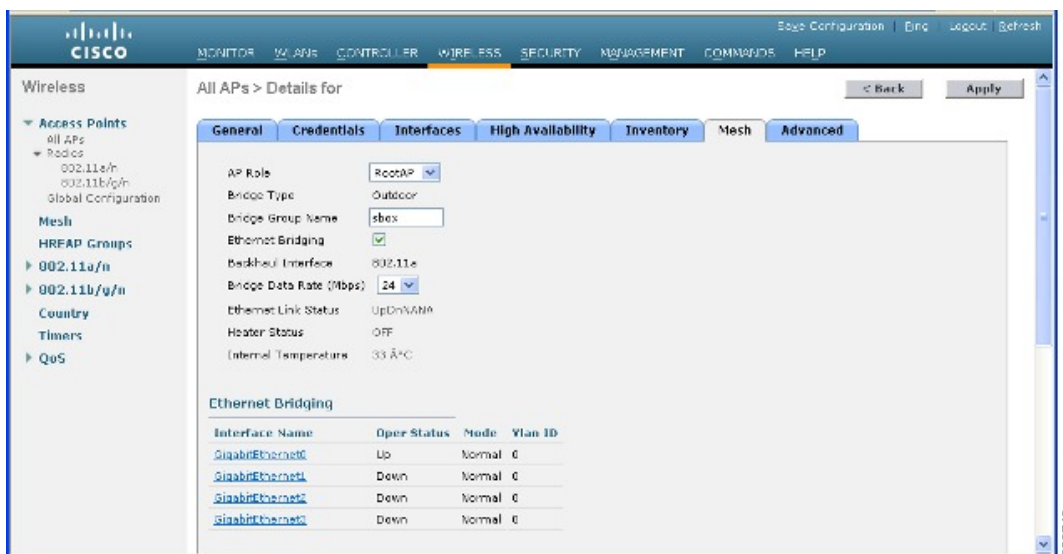
- A MAP that fails to connect to a controller on a UP Ethernet port, sets the 802.11a/n radio as the primary backhaul. If a MAP fails to find a neighbor or fails to connect to a controller through a neighbor, the Ethernet port is set as the primary backhaul again.
- A MAP connected to a controller over an Ethernet port does not build a mesh topology (unlike a RAP).
- A RAP always sets the Ethernet port as the primary backhaul.
- If the Ethernet port is DOWN on a RAP, or a RAP fails to connect to a controller on a UP Ethernet port, the 802.11a/n radio is set as the primary backhaul for 15 minutes. Failing to find a neighbor or failing to connect to a controller via any neighbor on the 802.11a/n radio causes the primary backhaul to go into the *scan* state. The primary backhaul begins its scan with the Ethernet port.

## Configuring the AP Role (GUI)

To configure the role of a mesh access point using the GUI, follow these steps:

- Step 1** Click **Wireless** to open the All APs page.
- Step 2** Click the name of an access point. The All APs > Details (General) page appears.
- Step 3** Click the **Mesh** tab.

**Figure 45: All APs > Details for (Mesh) Page**



- Step 4** Choose **RootAP** or **MeshAP** from the AP Role drop-down list.
- Step 5** Click **Apply** to commit your changes and to cause the access point to reboot.

## Configuring the AP Role (CLI)

To configure the role of a mesh access point using the CLI, enter the following command:

```
config ap role {rootAP | meshAP} Cisco_AP
```

## Configuring Multiple Controllers Using DHCP 43 and DHCP 60

To configure DHCP Option 43 and 60 for mesh access points in the embedded Cisco IOS DHCP server, follow these steps:

**Step 1** Enter configuration mode at the Cisco IOS CLI.

**Step 2** Create the DHCP pool, including the necessary parameters such as the default router and name server. The commands used to create a DHCP pool are as follows:

```
ip dhcp pool pool name
network IP Network Netmask
default-router Default router
dns-server DNS Server
```

where:

pool name is the name of the DHCP pool, such as AP1520  
 IP Network is the network IP address where the controller resides, such as 10.0.15.1  
 Netmask is the subnet mask, such as 255.255.255.0  
 Default router is the IP address of the default router, such as 10.0.0.1  
 DNS Server is the IP address of the DNS server, such as 10.0.10.2

**Step 3** Add the option 60 line using the following syntax:

```
option 60 ascii "VCI string"
```

For the VCI string, use one of the values below. The quotation marks must be included.

For Cisco 1550 series access points, enter "Cisco AP c1550"  
 For Cisco 1520 series access points, enter "Cisco AP c1520"  
 For Cisco 1240 series access points, enter "Cisco AP c1240"  
 For Cisco 1130 series access points, enter "Cisco AP c1130"

**Step 4** Add the option 43 line using the following syntax:

```
option 43 hex hex string
```

The hex string is assembled by concatenating the TLV values shown below:

Type + Length + Value

Type is always f1(hex). Length is the number of controller management IP addresses times 4 in hex. Value is the IP address of the controller listed sequentially in hex.



For example, suppose that there are two controllers with management interface IP addresses 10.126.126.2 and 10.127.127.2. The type is f1(hex). The length is  $2 * 4 = 8 = 08$  (hex). The IP addresses translate to 0a7e7e02 and 0a7f7f02. Assembling the string then yields f1080a7e7e020a7f7f02.

The resulting Cisco IOS command added to the DHCP scope is listed below:

```
option 43 hex f1080a7e7e020a7f7f02
```

---

## Backup Controllers

A single controller at a centralized location can act as a backup for mesh access points when they lose connectivity with the primary controller in the local region. Centralized and regional controllers need not be in the same mobility group. Using the controller GUI or CLI, you can specify the IP addresses of the backup controllers, which allows the mesh access points to fail over to controllers outside of the mobility group.

You can also configure primary and secondary backup controllers (which are used if primary, secondary, or tertiary controllers are not specified or are not responsive) for all access points connected to the controller as well as various timers, including the heartbeat timer and discovery request timers.

**Note**

The fast heartbeat timer is not supported on access points in bridge mode. The fast heartbeat timer is configured only on access points in local and FlexConnect modes.

The mesh access point maintains a list of backup controllers and periodically sends primary discovery requests to each entry on the list. When the mesh access point receives a new discovery response from a controller, the backup controller list is updated. Any controller that fails to respond to two consecutive primary discovery requests is removed from the list. If the mesh access point's local controller fails, it chooses an available controller from the backup controller list in this order: primary, secondary, tertiary, primary backup, and secondary backup. The mesh access point waits for a discovery response from the first available controller in the backup list and joins the controller if it receives a response within the time configured for the primary discovery request timer. If the time limit is reached, the mesh access point assumes that the controller cannot be joined and waits for a discovery response from the next available controller in the list.

**Note**

When a mesh access point's primary controller comes back online, the mesh access point disassociates from the backup controller and reconnects to its primary controller. The mesh access point falls back to its primary controller and not to any secondary controller for which it is configured. For example, if a mesh access point is configured with primary, secondary, and tertiary controllers, it fails over to the tertiary controller when the primary and secondary controllers become unresponsive and waits for the primary controller to come back online so that it can fall back to the primary controller. The mesh access point does not fall back from the tertiary controller to the secondary controller if the secondary controller comes back online; it stays connected to the tertiary controller until the primary controller comes back up.

## Configuring Backup Controllers (GUI)

Using the controller GUI, follow these steps to configure primary, secondary, and tertiary controllers for a specific mesh access point and to configure primary and secondary backup controllers for all mesh access points:

- Step 1** Choose **Wireless > Access Points > Global Configuration** to open the Global Configuration page (see [Figure 46: Global Configuration Page](#), on page 110).

**Figure 46: Global Configuration Page**

The screenshot shows the Cisco Wireless Global Configuration page. The left sidebar contains a navigation menu with options like Access Points, Mesh, H-REAP Groups, and QoS. The main content area is titled 'Global Configuration' and includes an 'Apply' button. The configuration is organized into several sections:

- CDP**: CDP State is checked.
- Login Credentials**: Username is 'user', Password and Enable Password are masked with asterisks.
- 802.1x Supplicant Credentials**: 802.1x Authentication is unchecked.
- AP Failover Priority**: Global AP Failover Priority is set to 'Enable'.
- High Availability**:
  - Local Mode AP Fast Heartbeat Timer State: Enable
  - Local Mode AP Fast Heartbeat Timeout(1 to 10): 10
  - H-REAP Mode AP Fast Heartbeat Timer State: Disable
  - AP Primary Discovery Timeout(30 to 3600): 120
  - Back-up Primary Controller IP Address: 209.165.200.225
  - Back-up Primary Controller name: controller1
  - Back-up Secondary Controller IP Address: 0.0.0.0
  - Back-up Secondary Controller name: (empty)

**Note** The fast heartbeat timer is not supported on mesh access points.

- Step 2** In the AP Primary Discovery Timeout field, enter a value between 30 and 3600 seconds (inclusive) to configure the access point primary discovery request timer. The default value is 120 seconds.

- Step 3** If you want to specify a primary backup controller for all access points, specify the IP address of the primary backup controller in the Back-up Primary Controller IP Address field and the name of the controller in the Back-up Primary Controller Name field.

**Note** The default value for the IP address is 0.0.0.0, which disables the primary backup controller.

- Step 4** If you want to specify a secondary backup controller for all access points, specify the IP address of the secondary backup controller in the Back-up Secondary Controller IP Address field and the name of the controller in the Back-up Secondary Controller Name field.
- Note** The default value for the IP address is 0.0.0.0, which disables the secondary backup controller.
- Step 5** Click **Apply** to commit your changes.
- Step 6** If you want to configure primary, secondary, and tertiary backup controllers for a specific point, follow these steps:
- Choose **Access Points > All APs** to open the All APs page.
  - Click the name of the access point for which you want to configure primary, secondary, and tertiary backup controllers.
  - Click the **High Availability** tab.
  - If desired, specify the name and IP address of the primary backup controller for this access point in the Primary Controller fields.  
**Note** Specifying an IP address for the backup controller is optional in this step and the next two steps. If the backup controller is outside the mobility group to which the mesh access point is connected (the primary controller), then you need to provide the IP address of the primary, secondary, or tertiary controller, respectively. The controller name and IP address must belong to the same primary, secondary, or tertiary controller. Otherwise, the mesh access point cannot join the backup controller.
  - If desired, specify the name and IP address of the secondary backup controller for this mesh access point in the Secondary Controller fields.
  - If desired, specify the name and IP address of the tertiary backup controller for this mesh access point in the Tertiary Controller fields.
  - No change is required to the AP Failover Priority value. The default value for mesh access points is critical and it cannot be modified.
  - Click **Apply** to commit your changes.
- Step 7** Click **Save Configuration** to save your changes.
- 

## Configuring Backup Controllers (CLI)

Using the controller CLI, follow these steps to configure primary, secondary, and tertiary controllers for a specific mesh access point and to configure primary and secondary backup controllers for all mesh access points.

---

- Step 1** To configure a primary controller for a specific mesh access point, enter this command:  
**config ap primary-base controller\_name Cisco\_AP [controller\_ip\_address]**
- Note** The *controller\_ip\_address* parameter in this command and the next two commands is optional. If the backup controller is outside the mobility group to which the mesh access point is connected (the primary controller), then you need to provide the IP address of the primary, secondary, or tertiary controller, respectively. In each command, the *controller\_name* and *controller\_ip\_address* must belong to the same primary, secondary, or tertiary controller. Otherwise, the mesh access point cannot join the backup controller.
- Step 2** To configure a secondary controller for a specific mesh access point, enter this command:  
**config ap secondary-base controller\_name Cisco\_AP [controller\_ip\_address]**
- Step 3** To configure a tertiary controller for a specific mesh access point, enter this command:  
**config ap tertiary-base controller\_name Cisco\_AP [controller\_ip\_address]**

- Step 4** To configure a primary backup controller for all mesh access points, enter this command:  
**config advanced backup-controller primary** *backup\_controller\_name backup\_controller\_ip\_address*
- Step 5** To configure a secondary backup controller for all mesh access points, enter this command:  
**config advanced backup-controller secondary** *backup\_controller\_name backup\_controller\_ip\_address*
- Note** To delete a primary or secondary backup controller entry, enter 0.0.0.0 for the controller IP address.
- Step 6** To configure the mesh access point primary discovery request timer, enter this command:  
**config advanced timers ap-primary-discovery-timeout** *interval*  
 where *interval* is a value between 30 and 3600 seconds. The default value is 120 seconds.
- Step 7** To configure the mesh access point discovery timer, enter this command:  
**config advanced timers ap-discovery-timeout** *interval*  
 where *interval* is a value between 1 and 10 seconds (inclusive). The default value is 10 seconds.
- Step 8** To configure the 802.11 authentication response timer, enter this command:  
**config advanced timers auth-timeout** *interval*  
 where *interval* is a value between 10 and 600 seconds (inclusive). The default value is 10 seconds.
- Step 9** To save your changes, enter this command:  
**save config**
- Step 10** To view a mesh access point's configuration, enter these commands:
- **show ap config general** *Cisco\_AP*
  - **show advanced backup-controller**
  - **show advanced timers**
  - **show mesh config**

Information similar to the following appears for the **show ap config general** *Cisco\_AP* command:

```

Cisco AP Identifier..... 1
Cisco AP Name..... AP5
Country code..... US - United States
Regulatory Domain allowed by Country..... 802.11bg:-AB 802.11a:-AB
AP Country code..... US - United States
AP Regulatory Domain..... 802.11bg:-A 802.11a:-N
Switch Port Number ..... 1
MAC Address..... 00:13:80:60:48:3e
IP Address Configuration..... DHCP
IP Address..... 1.100.163.133
...
Primary Cisco Switch Name..... 1-4404
Primary Cisco Switch IP Address..... 2.2.2.2
Secondary Cisco Switch Name..... 1-4404
Secondary Cisco Switch IP Address..... 2.2.2.2
Tertiary Cisco Switch Name..... 2-4404
Tertiary Cisco Switch IP Address..... 1.1.1.4

```

Information similar to the following appears for the **show advanced backup-controller** command:

```
AP primary Backup Controller ..... controller1 10.10.10.10
AP secondary Backup Controller ..... 0.0.0.0
```

Information similar to the following appears for the **show advanced timers** command:

```
Authentication Response Timeout (seconds)..... 10
Rogue Entry Timeout (seconds)..... 1300
AP Heart Beat Timeout (seconds)..... 30
AP Discovery Timeout (seconds)..... 10
AP Primary Discovery Timeout (seconds)..... 120
```

Information similar to the following appears for the **show mesh config** command:

```
Mesh Range..... 12000
Backhaul with client access status..... disabled
Background Scanning State..... enabled
Mesh Security
Security Mode..... EAP
External-Auth..... disabled
Use MAC Filter in External AAA server..... disabled
Force External Authentication..... disabled
Mesh Alarm Criteria
Max Hop Count..... 4
Recommended Max Children for MAP..... 10
Recommended Max Children for RAP..... 20
Low Link SNR..... 12
High Link SNR..... 60
Max Association Number..... 10
Association Interval..... 60 minutes
Parent Change Numbers..... 3
Parent Change Interval..... 60 minutes
Mesh Multicast Mode..... In-Out
Mesh Full Sector DFS..... enabled
Mesh Ethernet Bridging VLAN Transparent Mode..... enabled
```

## Configuring External Authentication and Authorization Using a RADIUS Server

External authorization and authentication of mesh access points using a RADIUS server such as Cisco ACS (4.1 and later) is supported in release 5.2 and later releases. The RADIUS server must support the client authentication type of EAP-FAST with certificates.

Before you employ external authentication within the mesh network, ensure that you make these changes:

- The RADIUS server to be used as an AAA server must be configured on the controller.
- The controller must also be configured on the RADIUS server.

- Add the mesh access point configured for external authorization and authentication to the user list of the RADIUS server.
  - For additional details, see the Adding a Username to a RADIUS Server section.
- Configure EAP-FAST on the RADIUS server and install the certificates. EAP-FAST authentication is required if mesh access points are connected to the controller using an 802.11a interface; the external RADIUS servers need to trust Cisco Root CA 2048. For information about installing and trusting the CA certificates, see the Configuring RADIUS Servers section.



**Note** If mesh access points connect to a controller using a Fast Ethernet or Gigabit Ethernet interface, only MAC authorization is required.



**Note** This feature also supports local EAP and PSK authentication on the controller.

## Configuring RADIUS Servers

To install and trust the CA certificates on the RADIUS server, follow these steps:

- 
- Step 1** Download the CA certificates for Cisco Root CA 2048 from the following locations:
- <http://www.cisco.com/security/pki/certs/crca2048.cer>
  - <http://www.cisco.com/security/pki/certs/cmca.cer>
- Step 2** Install the certificates as follows:
- From the CiscoSecure ACS main menu, click **System Configuration > ACS Certificate Setup > ACS Certification Authority Setup**.
  - In the **CA certificate file** box, type the CA certificate location (path and name). For example: C:\Certs\crca2048.cer.
  - Click **Submit**.
- Step 3** Configure the external RADIUS servers to trust the CA certificate as follows:
- From the CiscoSecure ACS main menu, choose **System Configuration > ACS Certificate Setup > Edit Certificate Trust List**. The Edit Certificate Trust List appears.
  - Select the check box next to the **Cisco Root CA 2048 (Cisco Systems)** certificate name.
  - Click **Submit**.
  - To restart ACS, choose **System Configuration > Service Control**, and then click **Restart**.
- 

For additional configuration details on Cisco ACS servers, see the following:

- [http://www.cisco.com/en/US/products/sw/secursw/ps2086/products\\_installation\\_and\\_configuration\\_guides\\_list.html](http://www.cisco.com/en/US/products/sw/secursw/ps2086/products_installation_and_configuration_guides_list.html)(Windows)
- <http://www.cisco.com/en/US/products/sw/secursw/ps4911/>(UNIX)

## Adding a Username to a RADIUS Server

Add MAC addresses of mesh access point that are authorized and authenticated by external RADIUS servers to the user list of that server *prior* to enabling RADIUS authentication for a mesh access point.

For remote authorization and authentication, EAP-FAST uses the manufacturer's certificate (CERT) to authenticate the child mesh access point. Additionally, this manufacturer certificate-based identity serves as the username for the mesh access point in user validation.

For Cisco IOS-based mesh access points, in addition to adding the MAC address to the user list, you need to enter the *platform\_name\_string-MAC\_address* string to the user list (for example, c1240-001122334455). The controller first sends the MAC address as the username; if this first attempt fails, then the controller sends the *platform\_name\_string-MAC\_address* string as the username.

**Note**

---

The Authentication MAC address is different for outdoor versus indoor APs. Outdoor APs use the AP's BVI MAC address, whereas indoor APs use the AP's Gigabit Ethernet MAC address.

---

### RADIUS Server Username Entry

For each mesh access point, two entries must be added to the RADIUS server, the *platform\_name\_string-MAC\_address* string, then a hyphen delimited MAC Address. For example:

- platform\_name\_string-MAC\_address  
User: c1520-aabbccddeeff  
Password: cisco
- Hyphen Delimited MAC Address  
User: aa-bb-cc-dd-ee-ff  
Password: aa-bb-cc-dd-ee-ff

**Note**

---

The AP1552 platform uses a platform name of c1520.

---

## Enabling External Authentication of Mesh Access Points (GUI)

To enable external authentication for a mesh access point using the GUI, follow these steps:

- Step 1** Choose **Wireless > Mesh**. The Mesh page appears (see [Figure 47: Mesh Page](#), on page 116).

**Figure 47: Mesh Page**

The screenshot shows the Cisco GUI for configuring a mesh access point. The 'Wireless' menu is open, and the 'Mesh' page is displayed. The 'General' section includes a 'Range (RootAP to MeshAP)' field set to 12000 feet, and checkboxes for 'IDS (Rogue and Signature Detection)' and 'Backhaul Client Access', both of which are checked and labeled 'Enabled'. The 'Ethernet Bridging' section has a 'VLAN Transparent' checkbox checked and labeled 'Enabled'. The 'Security' section has a 'Security Mode' dropdown menu set to 'EAP', and checkboxes for 'External MAC Filter Authorization' and 'Force External Authentication', both checked and labeled 'Enabled'. At the bottom, there is a table with columns for 'Server ID', 'Server Address', 'Port', and 'Enabled'. The table contains one entry: Server ID 1, Server Address 1.2.3.4, Port 1812, and Enabled.

- Step 2** In the security section, select the **EAP** option from the Security Mode drop-down list.
- Step 3** Select the **Enabled** check boxes for the External MAC Filter Authorization and Force External Authentication options.
- Step 4** Click **Apply**.
- Step 5** Click **Save Configuration**.

## Enable External Authentication of Mesh Access Points (CLI)

To enable external authentication for mesh access points using the CLI, enter the following commands:

- Step 1** `config mesh security eap`
- Step 2** `config macfilter mac-delimiter colon`
- Step 3** `config mesh security rad-mac-filter enable`
- Step 4** `config mesh radius-server index enable`
- Step 5** `config mesh security force-ext-auth enable` (Optional)



## View Security Statistics (CLI)

To view security statistics for mesh access points using the CLI, enter the following command:

```
show mesh security-stats Cisco_AP
```

Use this command to display packet error statistics and a count of failures, timeouts, and association and authentication successes as well as reassociations and reauthentications for the specified access point and its child.

## Configuring Global Mesh Parameters

This section provides instructions to configure the mesh access point to establish a connection with the controller including:

- Setting the maximum range between RAP and MAP (not applicable to indoor MAPs).
- Enabling a backhaul to carry client traffic.
- Defining if VLAN tags are forwarded or not.
- Defining the authentication mode (EAP or PSK) and method (local or external) for mesh access points including security settings (local and external authentication).

You can configure the necessary mesh parameters using either the GUI or the CLI. All parameters are applied globally.

## Configuring Global Mesh Parameters (GUI)

To configure global mesh parameters using the controller GUI, follow these steps:

**Step 1** Choose **Wireless > Mesh**.

**Step 2** Modify the mesh parameters as appropriate.

**Table 30: Global Mesh Parameters**

Parameter	Description
Range (RootAP to MeshAP)	<p>The optimum distance (in feet) that should exist between the root access point (RAP) and the mesh access point (MAP). This global parameter applies to all mesh access points when they join the controller and all existing mesh access points in the network.</p> <p><b>Range:</b> 150 to 132,000 feet</p> <p><b>Default:</b> 12,000 feet</p> <p><b>Note</b> After this feature is enabled, all mesh access points reboot.</p>

Parameter	Description
IDS (Rogue and Signature Detection)	<p>When you enable this feature, IDS reports are generated for all traffic on the client access only and not on the backhaul.</p> <p>When you disable this feature, no IDS reports are generated, which preserves bandwidth on the backhaul.</p> <p>You have to use the following command to enable or disable it on the mesh APs:</p> <pre><b>config mesh ids-state</b> {enable   disable}</pre> <p><b>Note</b> 2.4GHz IDS is activated with the global IDS settings on the controller.</p>
Backhaul Client Access	<p><b>Note</b> This parameter applies to mesh access points with two or more radios (1552, 1524SB, 1522, 1240, 1130, and 11n indoor mesh APs) <i>excluding</i> the 1524PS. When Backhaul Client Access is enabled, it allows wireless client association over the backhaul radio. Generally, backhaul radio is a 5-GHz radio for most of the mesh access points except for 1522 where backhaul can be 2.4 GHz. This means that a backhaul radio can carry both backhaul traffic and client traffic.</p> <p>When Backhaul Client Access is disabled, only backhaul traffic is sent over the backhaul radio and client association is only over the second radio(s).</p> <p><b>Default:</b> Disabled</p> <p><b>Note</b> After this feature is enabled, all mesh access points reboot.</p>
VLAN Transparent	<p>This feature determines how a mesh access point handles VLAN tags for Ethernet bridged traffic.</p> <p><b>Note</b> See the Configuring Advanced Features section for overview and additional configuration details.</p> <p>If VLAN Transparent is enabled, then VLAN tags are not handled and packets are bridged as untagged packets.</p> <p><b>Note</b> No configuration of Ethernet ports is required when VLAN transparent is enabled. The Ethernet port passes both tagged and untagged frames without interpreting the frames.</p> <p>If VLAN Transparent is disabled, then all packets are handled according to the VLAN configuration on the port (trunk, access, or normal mode).</p> <p><b>Note</b> If the Ethernet port is set to Trunk mode, then Ethernet VLAN tagging must be configured. See the Enabling Ethernet Bridging (GUI) section.</p> <p><b>Note</b> For an overview of normal, access, and trunk Ethernet port use, see the Ethernet Port Notes section.</p> <p><b>Note</b> To use VLAN tagging, you must uncheck the VLAN Transparent check box.</p> <p><b>Note</b> VLAN Transparent is enabled as a default to ensure a smooth software upgrade from 4.1.192.xxM releases to release 5.2. Release 4.1.192.xxM does not support VLAN tagging.</p> <p><b>Default:</b> Enabled.</p>

Parameter	Description
Security Mode	<p>Defines the security mode for mesh access points: Pre-Shared Key (PSK) or Extensible Authentication Protocol (EAP).</p> <p><b>Note</b> EAP must be selected if external MAC filter authorization using a RADIUS server is configured.</p> <p><b>Note</b> Local EAP or PSK authentication is performed within the controller if the External MAC Filter Authorization parameter is disabled (check box unchecked).</p> <p><b>Options:</b> PSK or EAP</p> <p><b>Default:</b> EAP</p>
External MAC Filter Authorization	<p>MAC filtering uses the local MAC filter on the controller by default.</p> <p>When external MAC filter authorization is enabled, if the MAC address is not found in the local MAC filter, then the MAC address in the external RADIUS server is used.</p> <p>This protects your network against rogue mesh access points by preventing mesh access points that are not defined on the external server from joining.</p> <p>Before employing external authentication within the mesh network, the following configuration is required:</p> <ul style="list-style-type: none"> <li>• The RADIUS server to be used as an AAA server must be configured on the controller.</li> <li>• The controller must also be configured on the RADIUS server.</li> <li>• The mesh access point configured for external authorization and authentication must be added to the user list of the RADIUS server. <ul style="list-style-type: none"> <li>◦ For remote authorization and authentication, EAP-FAST uses the manufacturer's certificate (CERT) to authenticate the child mesh access point. Additionally, this manufacturer certificate-based identity serves as the username for the mesh access point in user validation.</li> <li>◦ For IOS-based mesh access points (1130, 1240, 1522, 1524), the platform name of the mesh access point is located in front of its Ethernet address within the certificate; therefore, their username for external RADIUS servers is <i>platform_name_string-Ethernet MAC address</i> such as <i>c1520-001122334455</i>.</li> </ul> </li> <li>• The certificates must be installed and EAP-FAST must be configured on the RADIUS server.</li> </ul> <p><b>Note</b> When this capability is not enabled, by default, the controller authorizes and authenticates mesh access points using the MAC address filter.</p> <p><b>Default:</b> Disabled.</p>
Force External Authorization	<p>When enabled along with <i>EAP</i> and <i>External MAC Filter Authorization</i> parameters, external authorization and authentication of mesh access points is done by default by an external RADIUS server (such as Cisco 4.1 and later). The RADIUS server overrides local authentication of the MAC address by the controller which is the default.</p> <p><b>Default:</b> Disabled.</p>

- Step 3** Click **Apply**.
- Step 4** Click **Save Configuration**.
- 

## Configuring Global Mesh Parameters (CLI)

To configure global mesh parameters including authentication methods using the controller CLI, follow these steps:



**Note**

See the Configuring Global Mesh Parameters (GUI) section for descriptions, valid ranges, and default values of the parameters used in the CLI commands.

---

- 
- Step 1** To specify the maximum range (in feet) of all mesh access points in the network, enter this command:  
**config mesh range** *feet*
- To see the current range, enter the **show mesh range** command.
- Step 2** To enable or disable IDS reports for all traffic on the backhaul, enter this command:  
**config mesh ids-state** {enable | disable}
- Step 3** To specify the rate (in Mbps) at which data is shared between access points on the backhaul interface, enter this command:  
**config ap bhrate** {rate | auto} *Cisco\_AP*
- Step 4** To enable or disable client association on the primary backhaul (802.11a) of a mesh access point, enter these commands:  
**config mesh client-access** {enable | disable}  
**config ap wlan** {enable | disable} **802.11a** *Cisco\_AP*  
**config ap wlan** {add | delete} **802.11a** *wlan\_id* *Cisco\_AP*
- Step 5** To enable or disable VLAN transparent, enter this command:  
**config mesh ethernet-bridging VLAN-transparent** {enable | disable}
- Step 6** To define a security mode for the mesh access point, enter one of the following commands:
- To provide local authentication of the mesh access point by the controller, enter this command:  
**config mesh security** {eap | psk}
  - To store the MAC address filter in an external RADIUS server for authentication instead of the controller (local), enter these commands:  
**config macfilter mac-delimiter** colon  
**config mesh security rad-mac-filter** enable  
**config mesh radius-server** *index* enable
  - To provide external authentication on a RADIUS server and define a local MAC filter on the controller, enter these commands:

```

config mesh security eap
config macfilter mac-delimiter colon
config mesh security rad-mac-filter enable
config mesh radius-server index enable
config mesh security force-ext-auth enable

```

- d) To provide external authentication on a RADIUS server using a MAC username (such as c1520-123456) on the RADIUS server, enter these commands:

```

config macfilter mac-delimiter colon
config mesh security rad-mac-filter enable
config mesh radius-server index enable
config mesh security force-ext-auth enable

```

- Step 7** To save your changes, enter this command:  
**save config**

## Viewing Global Mesh Parameter Settings (CLI)

Use these commands to obtain information on global mesh settings:

- **show mesh client-access**—When Backhaul Client Access is enabled, it allows wireless client association over the backhaul radio. Generally, backhaul radio is a 5-GHz radio for most of the mesh access points except for 1522 where backhaul can be 2.4 GHz. This means that a backhaul radio can carry both backhaul traffic and client traffic.

When Backhaul Client Access is disabled, only backhaul traffic is sent over the backhaul radio and client association is only over the second radio(s).

```

(Cisco Controller)> show mesh client-access
Backhaul with client access status: enabled

```

- **show mesh ids-state**—Shows the status of the IDS reports on the backhaul as either enabled or disabled.

```

(Cisco Controller)> show mesh ids-state
Outdoor Mesh IDS(Rogue/Signature Detect): .... Disabled

```

- **show mesh config**—Displays global configuration settings.

```

(Cisco Controller)> show mesh config
Mesh Range..... 12000
Mesh Statistics update period..... 3 minutes
Backhaul with client access status..... disabled
Background Scanning State..... enabled
Backhaul Amsdu State..... disabled

Mesh Security
Security Mode..... EAP
External-Auth..... disabled
Use MAC Filter in External AAA server..... disabled
Force External Authentication..... disabled

```

```

Mesh Alarm Criteria
Max Hop Count..... 4
Recommended Max Children for MAP..... 10
Recommended Max Children for RAP..... 20
Low Link SNR..... 12
High Link SNR..... 60
Max Association Number..... 10
Association Interval..... 60 minutes
Parent Change Numbers..... 3
Parent Change Interval..... 60 minutes

Mesh Multicast Mode..... In-Out
Mesh Full Sector DFS..... enabled

Mesh Ethernet Bridging VLAN Transparent Mode..... enabled

```

## Backhaul Client Access

When Backhaul Client Access is enabled, it allows wireless client association over the backhaul radio. Generally, backhaul radio is a 5-GHz radio for most of the mesh access points except for 1522 where backhaul can be 2.4 GHz. This means that a backhaul radio can carry both backhaul traffic and client traffic.

When Backhaul Client Access is disabled, only backhaul traffic is sent over the backhaul radio and client association is only over the second radio(s).



### Note

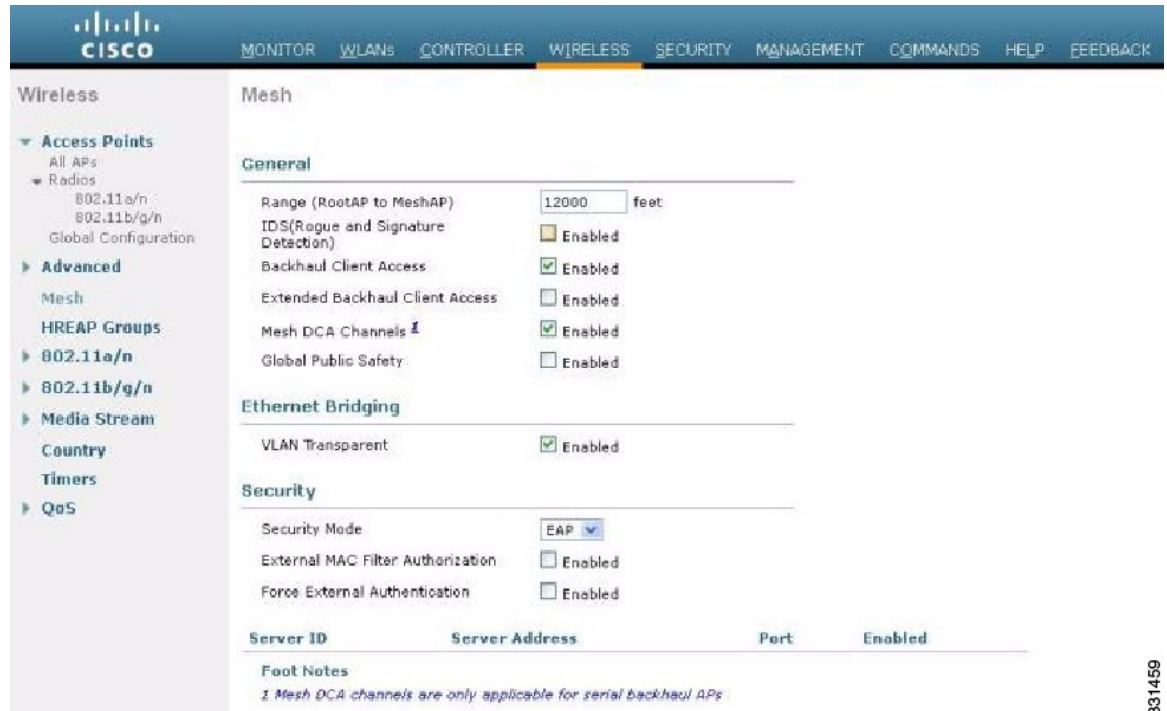
Backhaul Client Access is disabled by default. After this feature is enabled, all mesh access points, except slave AP and its child APs in Daisy-chained deployment, reboot.

This feature is applicable to mesh access points with two or more radios (1552, 1524SB, 1522, Indoor APs in mesh mode) excluding the 1524PS.

## Configuring Backhaul Client Access (GUI)

This figure shows how to enable Backhaul Client Access using the GUI. You will be prompted that the AP will reboot if you enable Backhaul Client Access.

**Figure 48: Configuring Backhaul Client Access using the GUI**



331459

## Configuring Backhaul Client Access (CLI)

Use the following command to enable Backhaul Client Access:

```
(Cisco Controller)> config mesh client-access enable
```

The following message is displayed:

```
All Mesh APs will be rebooted
Are you sure you want to start? (y/N)
```

## Backhaul Client Access on Serial Backhaul Access Points

With Backhaul Client Access, you can have client access on the backhaul 802.11a radios in addition to the backhaul functionality. This feature is applicable to mesh access points with two or more radios (1552, 1524SB, 1522, Indoor APs in mesh mode) excluding the 1524PS.

The dual 5-GHz Backhaul Client Access feature is intended for the serial backhaul access point platform, which has three radio slots. The radio in slot 0 operates in the 2.4-GHz band and is used for client access. The

radios in slot 1 and slot 2 operate in the 5-GHz band and are primarily used for backhaul. However, with the Backhaul Client Access feature, clients were allowed to associate over the slot 1 radio. But slot 2 radio was used only for backhaul. With the 7.0 release, client access over the slot 2 radio is allowed with this Dual 5-GHz Universal Access feature.

By default, client access is disabled over both the backhaul radios. Follow the guidelines to enable or disable client access on the radio slots that constitute 5-GHz radios, irrespective of the radios being used as downlinks or uplinks:

- You can enable client access on slot 1 even if client access on slot 2 is disabled.
- You can enable client access on slot 2 only when client access on slot 1 is enabled.
- If you disable client access on slot 1, client access on slot 2 is automatically disabled on the CLI.
- To disable only the extended client access (on the slot 2 radio), use the GUI.
- All the mesh access points reboot whenever client access is enabled or disabled.

The two 802.11a backhaul radios use the same MAC address. There may be instances where a WLAN maps to the same BSSID on more than one slot. Client access on the slot 2 radio is referred to as Extended Universal Access (EUA) in this document.

## Configuring Extended Universal Access (GUI)

- Step 1** Choose **Controller > Wireless > Mesh**.  
The Controller GUI when Backhaul Client Access is disabled page appears.

**Figure 49: Advanced Controller Settings for Mesh Page**

The screenshot displays the Cisco Controller GUI for the Mesh configuration page. The navigation menu on the left includes 'Wireless', 'Access Points', 'Radios', 'Advanced', 'Mesh', 'HREAP Groups', '802.11a/n', '802.11b/g/n', 'Media Stream', 'Country', 'Timers', and 'QoS'. The main configuration area is titled 'Mesh' and contains the following settings:

- General:**
  - Range (RootAP to MeshAP): 12000 feet
  - IDS(Rogue and Signature Detection):  Enabled
  - Backhaul Client Access:  Enabled
  - Mesh DCA Channels:  Enabled
- Ethernet Bridging:**
  - VLAN Transparent:  Enabled
- Security:**
  - Security Mode: EAP
  - External MAC Filter Authorization:  Enabled
  - Force External Authentication:  Enabled

At the bottom, there is a table with columns: Server ID, Server Address, Port, and Enabled. Below the table, a 'Foot Notes' section states: '1 Mesh DCA channels are only applicable for c15245B APs'.

279064



- Step 2** Select the **Backhaul Client Access** check box to display the **Extended Backhaul Client Access** check box.
- Step 3** Select the **Extended Backhaul Client Access** check box and click **Apply**. A message appears.
- Step 4** Click **OK**.  
After EUA is enabled, 802.11a radios appear.

**Figure 50: 802.11a Radios after EUA is Enabled**

The screenshot shows the Cisco Wireless Mesh Controller interface with the '802.11a/n Radios' configuration page. The table lists various radio configurations with columns for AP Name, Radio Slot#, Base Radio MAC, Sub Band, Admin Status, Operational Status, Channel, Clean-Air Admin Status, Clean-Air Oper Status, Radio Role, Power Level, and Antenna. Several rows are highlighted with colored boxes: a blue box around the RAPSB rows, a red box around the MAPSB rows, and a red box around the HMAP1 rows.

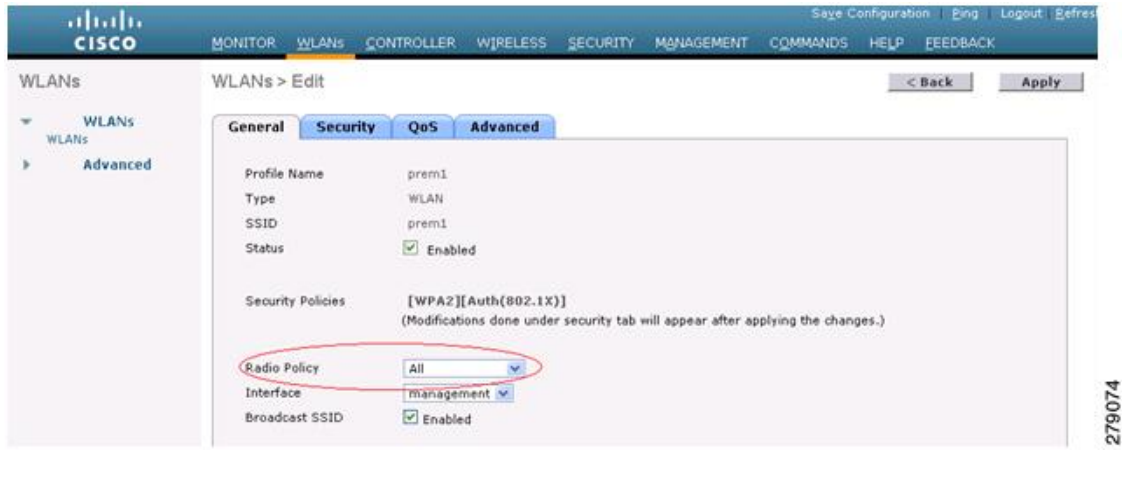
AP Name	Radio Slot#	Base Radio MAC	Sub Band	Admin Status	Operational Status	Channel	Clean-Air Admin Status	Clean-Air Oper Status	Radio Role	Power Level	Antenna
HPRAP1	1	00:1e:14:48:43:00	5.8GHz	Enable	UP	165	NA	NA	DOWNLINK	1	External
HPRAP1	2	00:1e:14:48:43:00	4.9GHz	Enable	UP	1	NA	NA	ACCESS	1	External
RAPSB	1	00:24:13:0f:92:00	-	Enable	UP	149	NA	NA	ACCESS	5	External
RAPSB	2	00:24:13:0f:92:00	-	Enable	UP	165	NA	NA	DOWNLINK ACCESS	5	External
HURAP1	1	00:1d:71:0d:e1:00	-	Enable	UP	161	NA	NA	DOWNLINK ACCESS	1	External
HMAP1	1	00:1b:04:a7:78:00	5.8GHz	Enable	UP	165	NA	NA	UPDOWNLINK	3	External
HMAP1	2	00:1b:04:a7:78:00	4.9GHz	Enable	UP	1	NA	NA	ACCESS	1	External
MAP1SB	1	00:24:50:34:21:00	-	Enable	UP	149	NA	NA	DOWNLINK ACCESS	1	External
MAP1SB	2	00:24:50:34:21:00	-	Enable	UP	165	NA	NA	UPLINK ACCESS	1	External
HMAP1	1	00:1d:71:0c:f4:00	-	Enable	UP	161	NA	NA	UPDOWNLINK ACCESS	5	External
HMAP3	1	00:1d:71:0d:d5:00	-	Enable	UP	161	NA	NA	UPDOWNLINK ACCESS	2	External
HMAP2	1	00:1d:71:0c:f0:00	-	Enable	UP	161	NA	NA	UPDOWNLINK ACCESS	2	External
MAP2SB	1	00:24:13:0e:bc:00	-	Enable	UP	157	NA	NA	DOWNLINK ACCESS	1	External
MAP2SB	2	00:24:13:0e:bc:00	-	Enable	UP	149	NA	NA	UPLINK ACCESS	1	External

Slot 2 in the 5-GHz radio in the RAPSB (serial backhaul) that is used to extend the backhaul in the DOWNLINK direction is displayed as DOWNLINK ACCESS, where slot 1 in the 5-GHz radio in the RAPSB that is used for client access is displayed as ACCESS. Slot 2 in the 5-GHz radio in the MAPSB that is used for the UPLINK is displayed as UPLINK ACCESS, and slot 1 in the MAPSB is used for the DOWNLINK ACCESS with an omnidirectional antenna that also provides the client access.

279068

Create WLAN on the WLC with the appropriate SSID mapped to the correct interface (VLAN). After you create a WLAN, it is applied to all the radios by default. If you want to enable client access only on 802.11a radios, choose only the appropriate radio policy from the list.

**Figure 51: Radio Policy Selection**



## Configuring Extended Universal Access (CLI)

### Before You Begin

- Go to the Controller prompt and enter the **config mesh client-access enable extended** command.

The following message is displayed:

```
Enabling client access on both backhaul slots
Same BSSIDs will be used on both slots
All Mesh Serial Backhaul APs will be rebooted
Are you sure you want to start? (y/N)
```

- Enter the **show mesh client-access** command to know the status of the backhaul with client access and the backhaul with client access extended.

The status is displayed as follows:

```
Backhaul with client access status: enabled
Backhaul with client access extended status(3 radio AP): enabled
```

- There is no explicit command to disable client access only on slot 2 (EUA). You have to disable client access on both the backhaul slots by entering the following command:

```
config mesh client-access disable
```

The following message is displayed:

```
All Mesh APs will be rebooted
```

Are you sure you want to start? (y/N)

- You can disable EUA from the GUI without disturbing client access on the slot 1 radio, but all 1524SB access points will be rebooted.

It is possible to enable client access only on slot 1 and not on slot 2 by entering the following command:

```
config mesh client-access enable
```

The following message is displayed:

```
All Mesh APs will be rebooted
Are you sure you want to start? (y/N)
```

## Configuring Extended Universal Access from Cisco Prime Infrastructure

- Step 1** Choose **Controllers > Controller IP Address > Mesh > Mesh Settings**.  
The Mesh page when Backhaul Client Access is disabled appears.

**Figure 52: Mesh Settings Page**



279066

- Step 2** Select the **Client Access on Backhaul Link** check box to display the Extended Backhaul Client Access check box.
- Step 3** Select the **Extended Backhaul Client Access** check box and click **Apply**. A message appears indicating the possible results of enabling the Extended Backhaul Client Access.
- Step 4** Click **OK** to continue.

## Configuring Local Mesh Parameters

After configuring global mesh parameters, you must configure the following local mesh parameters for these specific features if in use in your network:

- Backhaul Data Rate. See the [Configuring Wireless Backhaul Data Rate](#) section.
- Ethernet Bridging. See the [Configuring Ethernet Bridging](#) section.
- Bridge Group Name. See the [Configuring Ethernet Bridging](#) section.
- Workgroup Bridge. See the [Configuring Workgroup Bridges](#) section.
- Public Safety Band Settings. See the [Configuring Public Safety Band Settings](#) section.
- Cisco 3200 Series Association and Interoperability. See the WGB Interoperability Chart table.
- Power and Channel Setting. See the [Configuring Power and Channel Settings](#) section.
- Antenna Gain Settings. See the [Configuring Antenna Gain](#) section.
- Dynamic Channel Assignment. See the [Configuring Dynamic Channel Assignment](#) section.

### Configuring Wireless Backhaul Data Rate

Backhaul is used to create only the wireless connection between the access points. The backhaul interface by default is 802.11a or 802.11a/n depending upon the access point. The rate selection is important for effective use of the available RF spectrum. The rate can also affect the throughput of client devices, and throughput is an important metric used by industry publications to evaluate vendor devices.

Dynamic Rate Adaptation (DRA) introduces a process to estimate optimal transmission rate for packet transmissions. It is important to select rates correctly. If the rate is too high, packet transmissions fail resulting in communication failure. If the rate is too low, the available channel bandwidth is not used, resulting in inferior products, and the potential for catastrophic network congestion and collapse.

Data rates also affect the RF coverage and network performance. Lower data rates, for example 6 Mbps, can extend farther from the access point than can higher data rates, for example 300 Mbps. As a result, the data rate affects cell coverage and consequently the number of access points required. Different data rates are achieved by sending a more redundant signal on the wireless link, allowing data to be easily recovered from noise. The number of symbols sent out for a packet at the 1-Mbps data rate is higher than the number of symbols used for the same packet at 11 Mbps. Therefore, sending data at the lower bit rates takes more time than sending the equivalent data at a higher bit rate, resulting in reduced throughput.

In the controller release 5.2, the default data rate for the mesh 5-GHz backhaul is 24 Mbps. It remains the same with 6.0 and 7.0 controller releases.

With the 6.0 controller release, mesh backhaul can be configured for 'Auto' data rate. Once configured, the access point picks the highest rate where the next higher rate cannot be used because of conditions not being suitable for that rate and not because of conditions that affect all rates. That is, once configured, each link is free to settle down to the best possible rate for its link quality.

We recommend that you configure the mesh backhaul to Auto.

For example, if mesh backhaul chose 48 Mbps, then this decision is taken after ensuring that we cannot use 54 Mbps as there is not enough SNR for 54 and not because some just turned the microwave oven on which affects all rates.

A lower bit rate might allow a greater distance between MAPs, but there are likely to be gaps in the WLAN client coverage, and the capacity of the backhaul network is reduced. An increased bit rate for the backhaul network either requires more MAPs or results in a reduced SNR between MAPs, limiting mesh reliability and interconnection.

This figure shows the RAP using the "auto" backhaul data rate, and it is currently using 54 Mbps with its child MAP.

**Figure 53: Bridge Rate Set to Auto**



**Note**

The data rate can be set on the backhaul on a per-AP basis. It is not a global command.

**Related Commands**

Use these commands to obtain information about backhaul:

- **config ap bhrate**—Configures the Cisco Bridge backhaul Tx rate.

The syntax is as follows:

```
(controller) > config ap bhrate backhaul-rate ap-name
```



**Note**

Preconfigured data rates for each AP (RAP=18 Mbps, MAP1=36 Mbps) are preserved after the upgrade to 6.0 or later software releases. Before you upgrade to the 6.0 release, if you have the backhaul data rate configured to any data rate, then the configuration is preserved.

The following example shows how to configure a backhaul rate of 36000 Kbps on a RAP:

```
(controller) > config ap bhrate 36000 HPRAP1
```

- **show ap bhrate**—Displays the Cisco Bridge backhaul rate.

The syntax is as follows:

```
(controller) > show ap bhrate ap-name
```

- **show mesh neigh summary**—Displays the link rate summary including the current rate being used in backhaul

Example:

```
(controller) > show mesh neigh summary HPRAPI
```

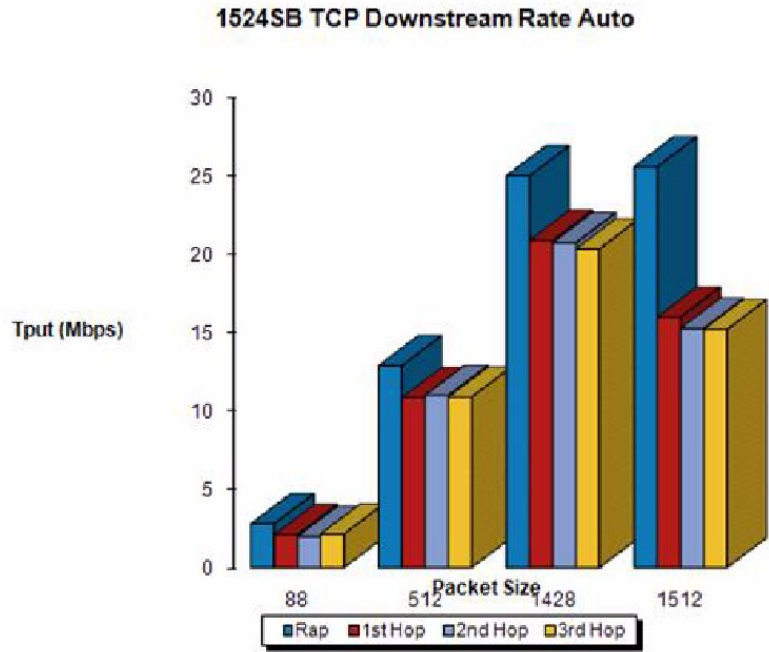
AP Name/Radio	Channel	Rate	Link-Snr	Flags	State
00:0B:85:5C:B9:20	0	auto	4	0x10e8fcb8	BEACON
00:0B:85:5F:FF:60	0	auto	4	0x10e8fcb8	BEACON DEFAULT
00:0B:85:62:1E:00	165	auto	4	0x10e8fcb8	BEACON
00:0B:85:70:8C:A0	0	auto	1	0x10e8fcb8	BEACON
HMAP1	165	54	40	0x36	CHILD BEACON
HJMAP2	0	auto	4	0x10e8fcb8	BEACON

Backhaul capacity and throughput depends upon the type of the AP, that is, if it is 802.11a/n or only 802.11a, number of backhaul radios it has, and so on.

In AP1524 SB, Slot 2 in the 5-GHz radio in the RAP is used to extend the backhaul in the downlink direction, whereas Slot 2 in the 5-GHz radio in the MAP is used for backhaul in the uplink. We recommend using a directional antenna with the Slot 2 radio. MAPs extend Slot 1 radio in the downlink direction with Omni or directional antenna also providing client access. Client access can be provided on the Slot 2 radio from the 7.0 release onwards.

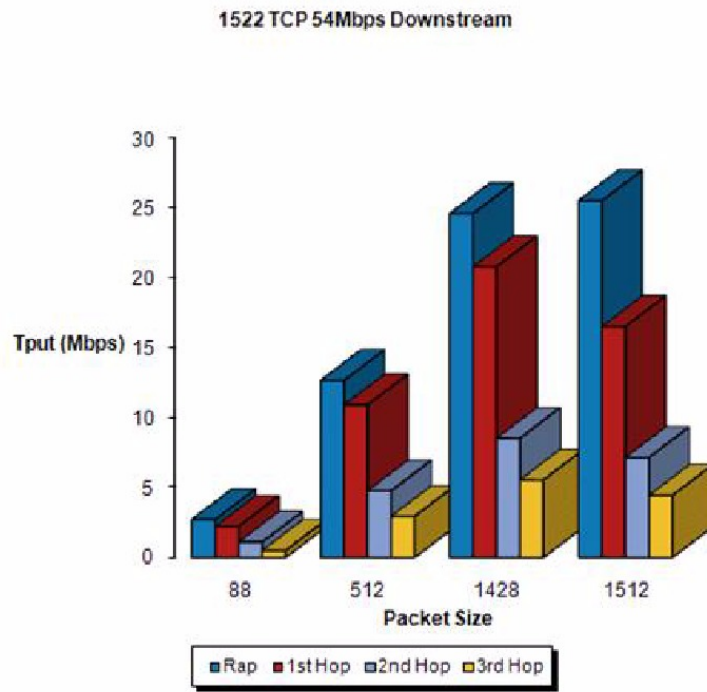
AP1524SB provides you with better throughput, and throughput rarely degrades after the first hop. The performance of AP1524SB is better than AP1522 and AP1524PS because these APs have only a single radio for the backhaul uplink and downlink (see the figures below).

**Figure 54: 1524SB TCP Downstream Rate Auto**



331461

**Figure 55: 1522 TCP 54 Mbps Downstream**



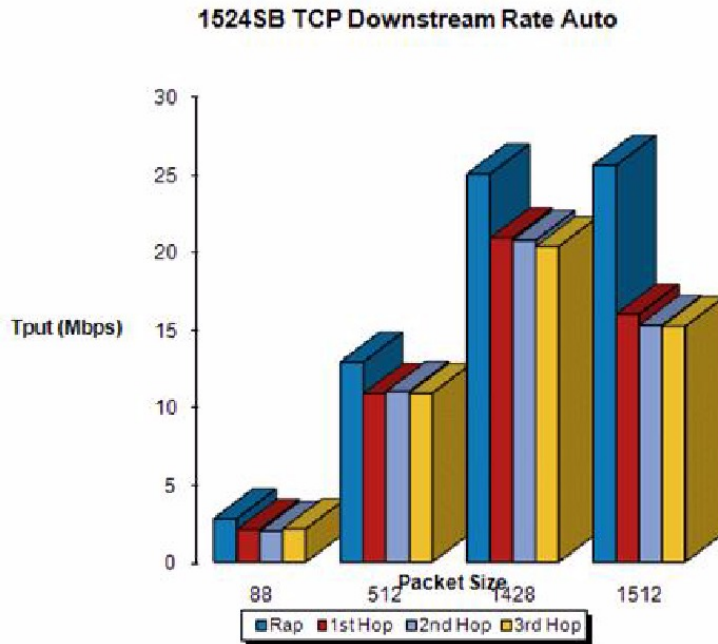
331462





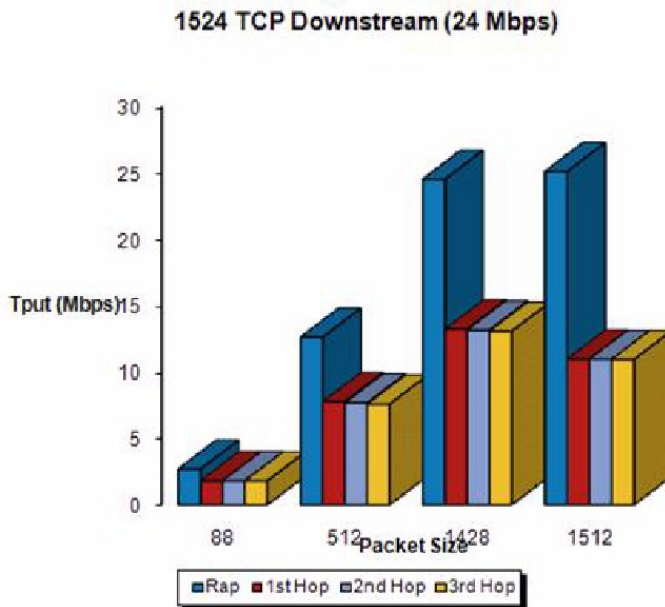
**Note** With DRA, each hop uses the best possible data rate for the backhaul. The data rate can be changed on a per-AP basis.

**Figure 56: 1524SB TCP Downstream Rate Auto**



331463

**Figure 57: 1524 TCP Downstream (24 Mbps)**

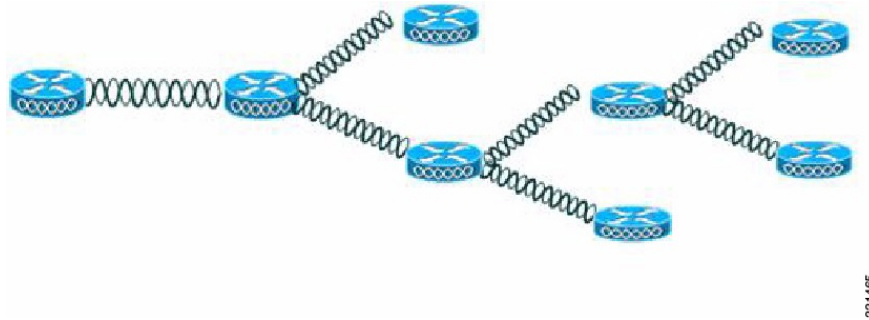


331464



**Note** Using 1552 802.11n provides you higher throughput and more capacity. It offers a very fat backhaul pipe to start with from the RAP.

**Figure 58: AP1552 Backhaul Throughput**



331465

**Table 31: AP1552 Backhaul Capacity**

Hops	RAP	One	Two	Three	Four
Maximum Throughput (20 MHz BH)	112 Mbps	83 Mbps	41 Mbps	25 Mbps	15 Mbps
Maximum Throughput (40 MHz BH)	206 Mbps	111 Mbps	94 Mbps	49 Mbps	35 Mbps

The requirements for the above are as follows:

- Packet size to be 1370 bytes (Veriwave Client)
- 5-GHz 802.11n
- MCS 15
- Less than 1 percent packet loss
- Greater than 40 dB SNR for client access and backhaul
- UDP traffic, security enabled, and universal access enabled

## Configuring Ethernet Bridging

For security reasons, the Ethernet port on all MAPs is disabled by default. It can be enabled only by configuring Ethernet bridging on the root and its respective MAP.

**Note**

Exceptions are allowed for a few protocols even though Ethernet bridging is disabled. For example, the following protocols are allowed:

- Spanning Tree Protocol (STP)
- Address Resolution Protocol (ARP)
- Control and Provisioning of Wireless Access Points (CAPWAP)
- Bootstrap Protocol (BOOTP) packets

Enable Spanning Tree Protocol (STP) on all connected switch ports to avoid Layer 2 looping.

Ethernet bridging has to be enabled for two scenarios:

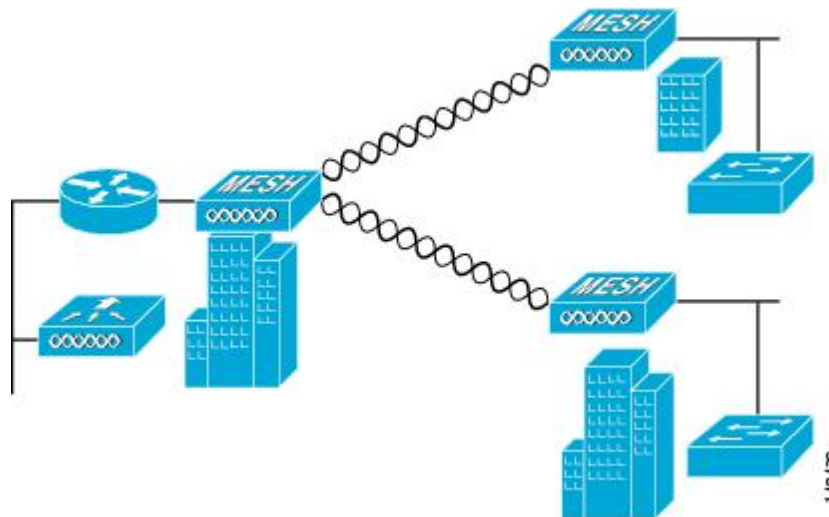
- 1 When you want to use the mesh nodes as bridges (see [Figure 59: Point-to-Multipoint Bridging](#), on page 136).

**Note**

You do not need to configure VLAN tagging to use Ethernet bridging for point-to-point and point-to-multipoint bridging deployments.

- 2 When you want to connect any Ethernet device such as a video camera on the MAP using its Ethernet port. This is the first step to enable VLAN tagging.

**Figure 59: Point-to-Multipoint Bridging**

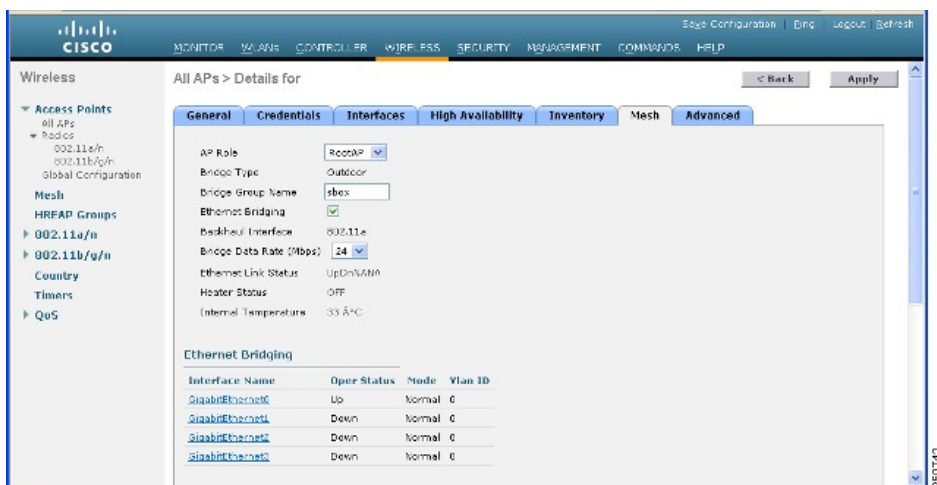


## Enabling Ethernet Bridging (GUI)

To enable Ethernet bridging on a RAP or MAP using the GUI, follow these steps:

- Step 1** Choose **Wireless > All APs**.
- Step 2** Click the AP name link of the mesh access point on which you want to enable Ethernet bridging.
- Step 3** At the details page, select the **Mesh** tab (see [Figure 60: All APs > Details for \(Mesh\) Page](#), on page 137).

**Figure 60: All APs > Details for (Mesh) Page**



- Step 4** Select either **RootAP** or **MeshAP** from the AP Role drop-down list, if not already selected.
- Step 5** Select the **Ethernet Bridging** check box to enable Ethernet bridging or deselect it to disable this feature.
- Step 6** Click **Apply** to commit your changes. An Ethernet Bridging section appears at the bottom of the page listing each of the Ethernet ports of the mesh access point.
- Step 7** Ensure that you enable Ethernet bridging for every parent mesh AP taking the path from the mesh AP in question to the controller. For example, if you enable Ethernet bridging on MAP2 in Hop 2, then you must also enable Ethernet bridging on MAP1 (parent MAP), and on the RAP connecting to the controller.

## Configuring Bridge Group Names

Bridge group names (BGNs) control the association of mesh access points. BGNs can logically group radios to avoid two networks on the same channel from communicating with each other. The setting is also useful if you have more than one RAP in your network in the same sector (area). BGN is a string of 10 characters maximum.

A BGN of *NULL VALUE* is assigned by default by manufacturing. Although not visible to you, it allows a mesh access point to join the network prior to your assignment of your network-specific BGN.

If you have two RAPs in your network in the same sector (for more capacity), we recommend that you configure the two RAPs with the same BGN, but on different channels.

## Configuring Bridge Group Names (CLI)

**Step 1** To set a bridge group name (BGN), enter this command:

```
config ap bridgegroupname set group-name ap-name
```

**Note** The mesh access point reboots after a BGN configuration.

**Caution** Exercise caution when you configure a BGN on a live network. Always start a BGN assignment from the farthest-most node (last node, bottom of mesh tree) and move up toward the RAP to ensure that no mesh access points are dropped due to mixed BGNs (old and new BGNs) within the same network.

**Step 2** To verify the BGN, enter the following command:

```
show ap config general ap-name
```

## Verifying Bridge Group Names (GUI)

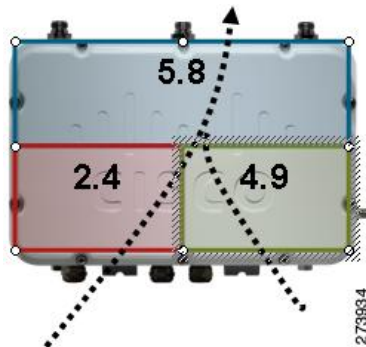
**Step 1** Click **Wireless > Access Points > AP Name**. The details page for the selected mesh access point appears.

**Step 2** Click the **Mesh** tab. Details for the mesh access point including the BGN appears.

## Configuring Public Safety Band Settings

A public safety band (4.9 GHz) is supported on the AP1522 and AP1524PS.

*Figure 61: AP 1524PS Diagram Showing Radio Placement*



- For the AP1524PS, the 4.9-GHz radio is independent of the 5-GHz radio and is not used for backhaul. The 5.8 GHz is used only for backhaul, and there is no client access possible on it. On the AP1524PS, the 4.9-GHz band is enabled by default.
  - In Japan, 4.9 GHz is enabled by default as 4.9 GHz is unlicensed.
- For AP1522s, you can enable the 4.9-GHz public safety band on the backhaul. This step can only be done at the global level and cannot be done on a per mesh access point basis.
  - For client access on the 4.9-GHz band on the AP1522, you have to enable the feature *backhaul client access*.
- For public safety-only deployments, the AP1522 and the AP1524PS must each be connected to its own separate RAP-based tree. For such deployments, the 1522 must use the 4.9-GHz backhaul and the 1524PS must be in its own RAP tree and use the 5.8-GHz backhaul.
- In some parts of the world including the USA, you can only have public safety traffic on the 4.9-GHz backhaul. Check the destination countries compliance before installing.

The 4.9-GHz subband radio on the AP1524PS supports public safety channels within the 5-MHz (channels 1 to 10), 10-MHz (channels 11 to 19), and 20-MHz (channels 20 to 26) bandwidths.

- The following data rates are supported within the 5 MHz bandwidth: 1.5, 2.25, 3, 4.5, 6, 9, 12, and 13.5 Mbps. The default rate is 6 Mbps.
- The following data rates are supported within the 10-MHz bandwidth: 3, 4.5, 6, 9, 12, 18, 24, and 27 Mbps. The default rate is 12 Mbps.

Those AP1522s with serial numbers prior to FTX1150XXXX do **not** support 5 and 10 MHz channels on the 4.9-GHz radio; however, a 20-MHz channel is supported.

- Those AP1522s with serial numbers after FTX1150XXXX support 5, 10, and 20 MHz channels.

## Enabling the 4.9-GHz Band

When you attempt to enable the 4.9-GHz band, you get a warning that the band is a licensed band in most parts of the world.

**Figure 62: Public Safety Warning During Configuration**

```
(Cisco Controller) >config mesh public-safety ?
enable      Enable/Disable 4.9GHz Public Safety Bands for Mesh AP.
disable     Enable/Disable 4.9GHz Public Safety Bands for Mesh AP.
(Cisco Controller) >config mesh public-safety enable ?
all         For All Cisco AP
(Cisco Controller) >config mesh public-safety enable all
4.9GHz is a licensed frequency band in -A domain for public-safety usage
Are you sure you want to continue? (y/N)y
      Global Public Safety State: Already configured, Configuring Local States
...
(Cisco Controller) >config mesh public-safety enable HJRap1
Public Safety can't be configured on individual Cisco APs.
```

- To verify that a public safety band is on the mesh access point using the CLI, enter the following command:

```
(Cisco Controller)> show mesh public-safety
Global Public Safety status: enabled
```

- To verify that a public safety band is on the mesh access point using the GUI:
  - Wireless > Access Points > 802.11a radio > Configure** (from the Antenna drop-down list)

## Configuring Interoperability with Cisco 3200

Cisco AP1522 and AP1524PS can interoperate with the Cisco 3200 on the public safety channel (4.9-GHz) as well as the 2.4-GHz access and 5.8-GHz backhaul.

The Cisco 3200 creates an in-vehicle network in which devices such as PCs, surveillance cameras, digital video recorders, printers, PDAs, and scanners can share wireless networks such as cellular or WLAN based services back to the main infrastructure. This feature allows data collected from in-vehicle deployments such as a police cars to be integrated into the overall wireless infrastructure.

This section provides configuration guidelines and step-by-step instructions for configuring interoperability between the Cisco 3200 and the AP1522 and the AP1524PS.

For specific interoperability details between series 1130, 1240, and 1520 (1522, 1524PS) mesh access points and Cisco 3200, see [Table 32: Mesh Access Points and Cisco 3200 Interoperability](#), on page 141.



**Table 32: Mesh Access Points and Cisco 3200 Interoperability**

Mesh Access Point Model	Cisco 3200 Model
1552, 1522 <sup>20</sup>	c3201 <sup>21</sup> , c3202 <sup>22</sup> , c3205 <sup>23</sup>
1524PS	c3201, c3202
1524SB, 1130, 1240, Indoor 802.11n mesh access points	c3201, c3205

<sup>20</sup> Universal access must be enabled on the AP1522 if connecting to a Cisco 3200 on the 802.11a radio or 4.9-GHz band.

<sup>21</sup> Model c3201 is a Cisco 3200 with a 802.11b/g radio (2.4-GHz).

<sup>22</sup> Model c3202 is a Cisco 3200 with a 4-9-GHz subband radio.

<sup>23</sup> Model c3205 is a Cisco 3200 with a 802.11a radio (5.8-GHz subband).

### Configuration Guidelines for Public Safety 4.9-GHz Band

For the AP1522 or AP1524PS and Cisco 3200 to interoperate on the public safety network, the following configuration guidelines must be met:

- Client access must be enabled on the backhaul (mesh global parameter). This feature is not supported on the AP1524PS.
- Public safety must be enabled globally on all mesh access points (MAPs) in the mesh network.
- The channel number assignment on the AP1522 or AP1524PS must match those on the Cisco 3200 radio interfaces:
  - Channels 20 (4950 GHz) through 26 (4980 GHz) and subband channels 1 through 19 (5 and 10 MHz) are used for Cisco 3200 interoperability. This configuration change is made on the controller. No changes are made to the mesh access point configuration.
  - Channel assignments are only made to the RAP. Updates to the MAP are propagated by the RAP.

The default channel width for Cisco 3200s is 5 MHz. You must *either* change the channel width to 10 or 20 MHz to enable WGBs to associate with the AP1522 and AP1524PS *or* change the channel on the AP1522 or AP1524PS to a channel in the 5-MHz band (channels 1 to 10) or 10-MHz band (channels 11 to 19).

- Radio (802.11a) must be disabled when configuring channels and then reenabled when using the CLI. When using the GUI, enabling and disabling of the 802.11a radio for channel configuration is not required.
- Cisco 3200s can scan channels *within* but not across the 5, 10 or 20-MHz bands.

## Enabling AP1522 to Associate with Cisco 3200 (GUI)

- 
- Step 1** To enable the backhaul for client access, choose **Wireless > Mesh** to access the Mesh page.
- Step 2** Select the Backhaul Client Access **Enabled** check box to allow wireless client association over the 802.11a radio. Click **Apply**.
- Note** You are prompted with a message to allow reboot of all the mesh access points to enable Backhaul Client Access on a network. Click **OK**.
- Step 3** To assign the channel to use for the backhaul (channels 20 through 26), click **Wireless > Access Points > Radio** and select **802.11a/n** from the Radio subheading. A summary page for all 802.11a radios displays.
- Step 4** At the Antenna drop-down list for the appropriate RAP, select **Configure**. The Configure page is displayed.
- Step 5** At the RF Backhaul Channel Assignment section, select the **Custom** option for the Assignment Method option and select any channel between 1 and 26.
- Step 6** Click **Apply** to commit your changes.
- Step 7** Click **Save Configuration** to save your changes.
- 

## Enabling 1522 and 1524PS Association with Cisco 3200 (CLI)

- 
- Step 1** To enable client access mode on the AP1522, enter this command:  
**config mesh client-access enable**
- Step 2** To enable the public safety on a global basis, enter this command:  
**config mesh public-safety enable all**
- Step 3** To enable the public safety channels, enter these commands:
- a) On the AP1522, enter these commands:  
**config 802.11a disable Cisco\_MAP**  
**config 802.11a channel ap Cisco\_MAP channel number**  
**config 802.11a enable Cisco\_MAP**
  - b) On the AP1524PS, enter these commands:  
**config 802.11-a49 disable Cisco\_MAP**  
**config 802.11-a49 channel ap Cisco\_MAP channel number**  
**config 802.11-a49 enable Cisco\_MAP**
- Note** Enter the **config 802.11-a58 enable Cisco\_MAP** command to enable a 5.8-GHz radio.
- Note** For both the AP1522 and AP1524PS, *channel number* is equal to any value 1 to 26.
- Step 4** To save your changes, enter this command:  
**save config**

**Step 5** To verify your configuration, enter these commands:

```
show mesh public-safety
```

```
show mesh client-access
```

```
show ap config 802.11a summary (1522 only)
```

```
show ap config 802.11-a49 summary (1524PS only)
```

**Note** Enter the **show config 802.11-a58 summary** command to display configuration details for a 5.8-GHz radio.

---

## Configuring Power and Channel Settings

The backhaul channel (802.11a/n) can be configured on a RAP. MAPs tune to the RAP channel. The local access can be configured independently for MAP.

## Configuring Power and Channel Settings (GUI)

---

**Step 1** Choose **Wireless > Access Points > 802.11a/n**.

**Note** Radio slots are displayed for each radio. For an AP1524SB, the 802.11a radio will display for slots 1 and 2 that operate in the 5-GHz band. For an AP1524PS, the 802.11a radio will display for slots 1 and 2, operating in the 5-GHz and 4.9-GHz bands respectively.

**Step 2** Select **configure** from the Antenna drop-down list for the 802.11a/n radio. The Configure page is displayed.

**Note** For the 1524SB, select the Antenna drop-down list for a RAP with a radio role of downlink.

**Step 3** Assign a channel (assignment methods of global and custom) for the radio.

**Note** When you assign a channel to the AP1524SB, choose the **Custom** assignment method, and select one of the supported channels for the 5-GHz band.

**Step 4** Assign Tx power levels (global and custom) for the radio.

There are five selectable power levels for the 802.11a backhaul for AP1500s.

**Note** The default Tx power level on the backhaul is the highest power level (Level 1).

**Note** Radio Resource Management (RRM) is OFF (disabled) by default. RRM cannot be turned ON (enabled) for the backhaul.

**Step 5** Click **Apply** when power and channel assignment are complete.

**Step 6** From the 802.11a/n Radios page, verify that channel assignments were made correctly.

---

## Configuring the Channels on the Serial Backhaul (CLI)

To configure channels on the serial backhaul of the RAP using the controller CLI, follow these steps:

- 
- Step 1** To configure the backhaul channel on the radio in slot 2 of the RAP, enter this command:  
**config slot 2 channel ap** *Cisco\_RAPSB channel*
- The available channels for the 5.8-GHz band are 149, 153, 157, 161, and 165.
- Step 2** To configure the transmit power level on the radio in slot 2 of the RAP, enter this command:  
**config slot 2 txPower ap** *Cisco\_RAPSB power*
- Valid values are 1 through 5; the default value is 1.
- Step 3** To display the configurations on the mesh access points, enter these commands:
- 

- **show mesh path** *MAP*

Information similar to the following appears:

AP Name/Radio	Channel	Rate	Link-Snr	Flags	State
MAP1SB	161	auto	60	0x10ea9d54	UPDATED NEIGH PARENT BEACON
RAPSB	153	auto	51	0x10ea9d54	UPDATED NEIGH PARENT BEACON

RAPSB is a Root AP.

- **show mesh backhaul** *RAPSB*

Information similar to the following appears:

```
Current Backhaul Slot(s)..... 1, 2,

Basic Attributes for Slot 1
  Radio Type..... RADIO_TYPE_80211a
  Radio Role..... ACCESS
  Administrative State ..... ADMIN_ENABLED
  Operation State ..... UP
  Current Tx Power Level ..... 1
  Current Channel ..... 165
  Antenna Type..... EXTERNAL_ANTENNA
  External Antenna Gain (in .5 dBm units)..... 0

Basic Attributes for Slot 2
  Radio Type..... RADIO_TYPE_80211a
  Radio Role..... RADIO_DOWNLINK
  Administrative State ..... ADMIN_ENABLED
  Operation State ..... UP
  Current Tx Power Level ..... 3
  Current Channel ..... 153
  Antenna Type..... EXTERNAL_ANTENNA
  External Antenna Gain (in .5 dBm units)..... 0
```

- **show ap channel** *MAPISB*

Information similar to the following appears:

```
802.11b/g Current Channel ..... 11
Slot Id ..... 0
Allowed Channel List..... 1,2,3,4,5,6,7,8,9,10,11
802.11a(5.8Ghz) Current Channel ..... 161
Slot Id ..... 1
Allowed Channel List..... 149,153,157,161,165
802.11a(5.8Ghz) Current Channel ..... 153
Slot Id ..... 2
Allowed Channel List..... 149,153,157,161,165
```

## Configuring Antenna Gain

You must configure the antenna gain for the mesh access point to match that of the antenna installed using the controller GUI or controller CLI.

### Configuring Antenna Gain (GUI)

To configure antenna parameters using the controller GUI, follow these steps:

- 
- Step 1** Choose **Wireless > Access Points > Radio > 802.11a/n** to open the 802.11a/n Radios page.
- Step 2** For the mesh access point antenna you want to configure, hover the mouse over the blue arrow (far right) to display antenna options. Choose **Configure**.
- Note** Only external antennas have configurable gain settings.
- Step 3** In the Antenna Parameters section, enter the antenna gain. The gain is entered in 0.5 dBm units. For example, 2.5 dBm = 5.
- Note** The entered gain value must match that value specified by the vendor for that antenna.
- Step 4** Click **Apply** and then **Save Configuration** to save the changes.
- 

### Configuring Antenna Gain (CLI)

Enter this command to configure the antenna gain for the 802.11a backhaul radio using the controller CLI:

```
config 802.11a antenna extAntGain antenna_gain AP_name
```

where gain is entered in 0.5-dBm units (for example, 2.5 dBm =5).

## Backhaul Channel Deselection on Serial Backhaul Access Point

This feature is applicable to mesh APs with two 5-GHz radios, such as 1524SB (serial backhaul).

The backhaul channel deselection feature helps you to restrict the set of channels available to be assigned for the serial backhaul MAPs and RAPs. Because 1524SB MAP channels are automatically assigned, this feature helps in regulating the set of channels that get assigned to mesh access points. For example, if you do not want channel 165 to get assigned to any of the 1524SB mesh access points, you need to remove channel 165 from the DCA list and enable this feature.

When you remove certain channels from the DCA list and enable the **mesh backhaul dca-channel** command, those channels will not be assigned to any serial backhaul access points in any scenario. Even if a radar is detected on all channels within the DCA list channels, the radio will be shut down rather than moved to channels outside it. A trap message is sent to the Prime Infrastructure, and the message is displayed showing that the radio has been shut down because of DFS. You will not be able to assign channels to the serial backhaul RAP outside of the DCA list with the **config mesh backhaul dca-channels enable** command enabled. However, this is not case for the APs with one 5-GHz radio such as 1552, 1522, and 1524PS APs. For these APs, you can assign any channel outside of the DCA list for a RAP, and the controller/AP can also select a channel outside of the DCA list if no radar-free channel is available from the list.

This feature is best suited in an interoperability scenario with indoor mesh access points or workgroup bridges that support a channel set that is different from outdoor access points. For example, channel 165 is supported by outdoor access points but not by indoor access points in the -A domain. By enabling the backhaul channel deselection feature, you can restrict the channel assignment to only those channels that are common to both indoor and outdoor access points.




---

**Note** Channel deselection is applicable to 7.0 and later releases.

In some scenarios, there may be two linear tracks or roads for mobility side by side. Because channel selection of MAPs happens automatically, there can be a hop at a channel, which is not available on the autonomous side, or the channel has to be skipped when the same or adjacent channel is selected in a neighborhood access point that belongs to a different linear chain.

---

## Configuring Backhaul Channel Deselection (GUI)

---

- Step 1** Choose **Controller > Wireless > 802.11a/n > RRM > DCA**  
The Dynamic Channel Assignment Algorithm page appears.
- Step 2** Select one or more channels to include in the DCA list.  
The channels included in the DCA list will not be assigned to the access points associated to this controller during automatic channel assignment.
- Step 3** Choose **Wireless > Mesh**  
The Mesh page appears.
- Step 4** Select the Mesh DCA Channels check box to enable the backhaul channel deselection using the DCA list. This option is applicable for serial backhaul access points.
- Step 5** After you enable the backhaul deselection option, choose **Wireless > Access Points > Radios > 802.11a/n** to configure the channel for the RAP downlink radio.
- Step 6** From the list of access points, click on the Antenna drop-down list for a RAP and choose **Configure**.  
The Configure page appears.

- Step 7** In the RF Backhaul Channel assignment section, choose **Custom**.
- Step 8** Select a channel for the RAP downlink radio from the drop-down list, which appears when you choose **Custom**.
- Step 9** Click **Apply** to apply and save the backhaul channel deselection configuration changes.

## Configuring Backhaul Channel Deselection (CLI)

To configure backhaul channel deselection using CLI, follow these steps:

- Step 1** From the controller prompt, enter the **show advanced 802.11a channel** command to review the channel list already configured in the DCA list.

```
(Controller) > show advanced 802.11a channel
Automatic Channel Assignment
Channel Assignment Mode..... AUTO
Channel Update Interval..... 600 seconds
Anchor time (Hour of the day)..... 0
Channel Update Contribution..... SNI..
CleanAir Event-driven RRM option..... Enabled
CleanAir Event-driven RRM sensitivity..... Medium
Channel Assignment Leader..... 09:2b:16:28:00:03
Last Run..... 286 seconds ago
DCA Sensitivity Level..... MEDIUM (15 dB)
DCA 802.11n Channel Width..... 20 MHz
DCA Minimum Energy Limit..... -95 dBm
Channel Energy Levels
  Minimum..... unknown
  Average..... unknown
  Maximum..... unknown
Channel Dwell Times
  Minimum..... 0 days, 17 h 02 m 05 s
  Average..... 0 days, 17 h 46 m 07 s
  Maximum..... 0 days, 18 h 28 m 58 s
802.11a 5 GHz Auto-RF Channel List

--More-- or (q)uit
  Allowed Channel List..... 36,40,44,48,52,56,60,64,116,
                             140
  Unused Channel List..... 100,104,108,112,120,124,128,
                             132,136
DCA Outdoor AP option..... Disabled
```

- Step 2** To add a channel to the DCA list, enter the **config advanced 802.11a channel add *channel number*** command, where *channel number* is the channel number that you want to add to the DCA list. You can also delete a channel from the DCA list by entering the **config advanced 802.11a channel delete *channel number*** command, where *channel number* is the channel number that you want to delete from the DCA list. Before you add or delete a channel to or from the DCA list, ensure that the 802.11a network is disabled.

- To disable the 802.11a network, enter the following command:

```
config 802.11a disable network
```

- To enable the 802.11a network, enter the following command:

```
config 802.11a enable network
```

You cannot directly delete a channel from the DCA list if it is assigned to any 1524 RAP. To delete a channel assigned to a RAP, you must first change the channel assigned to the RAP and then enter the **config advanced 802.11a channel delete** *channel number* command from the controller.

The following is a sample output of the **add channel** and **delete channel** commands:

```
(Controller) > config 802.11a disable network
```

```
Disabling the 802.11a network may strand mesh APs. Are you sure you want to continue? (y/n)y
```

```
(Controller) > config advanced 802.11a channel add 132
```

```
(Controller) > config advanced 802.11a channel delete 116
```

```
802.11a 5 GHz Auto-RF:
```

```
Allowed Channel List..... 36,40,44,48,52,56,60,64,116,  
                            132,140
```

```
DCA channels for cSerial Backhaul Mesh APs is enabled.
```

```
DCA list should have at least 3 non public safety channels supported by Serial Backhaul Mesh APs.
```

```
Otherwise, the Serial Backhaul Mesh APs can get stranded.
```

```
Are you sure you want to continue? (y/N)y
```

```
Failed to delete channel.
```

```
Reason: Channel 116 is configured for one of the Serial Backhaul RAPs.
```

```
Disable mesh backhaul dca-channels or configure a different channel for Serial Backhaul RAPs.
```

```
(Controller) > config advanced 802.11a channel delete 132
```

```
802.11a 5 GHz Auto-RF:
```

```
Allowed Channel List..... 36,40,44,48,52,56,60,64,116,132,140
```

```
DCA channels for Serial Backhaul Mesh APs is enabled.
```

```
DCA list should have at least 3 non public safety channels supported by Serial Backhaul Mesh APs.
```

```
Otherwise, the Serial Backhaul Mesh APs can get stranded.
```

```
Are you sure you want to continue? (y/N)y
```

```
(Controller) > config 802.11a enable network
```

**Step 3** After a suitable DCA list has been created, enter the **config mesh backhaul dca-channels enable** command to enable the backhaul channel deselection feature for mesh access points.

You can enter the **config mesh backhaul dca-channels disable** command if you want to disable the backhaul channel deselection feature for mesh access points.

It is not required that you disable 802.11a network to enable or disable this feature.



The following is a sample output:

```
(Controller) > config mesh backhaul dca-channels enable
```

```
802.11a 5 GHz Auto-RF:
```

```
  Allowed Channel List..... 36,40,44,48,52,56,60,64,116,
                             140
```

Enabling DCA channels for c1524 mesh APs will limit the channel set to the DCA channel list. DCA list should have at least 3 non public safety channels supported by Serial Backhaul Mesh APs. Otherwise, the Serial Backhaul Mesh APs can get stranded.  
Are you sure you want to continue? (y/N)y

```
(Controller) > config mesh backhaul dca-channels disable
```

#### Step 4

To check the current status of the backhaul channel deselection feature, enter the **show mesh config** command. The following is a sample output:

```
(Controller) > show mesh config
```

```
Mesh Range..... 12000
Mesh Statistics update period..... 3 minutes
Backhaul with client access status..... enabled
Background Scanning State..... enabled
Backhaul Amsdu State..... disabled

Mesh Security
  Security Mode..... PSK
  External-Auth..... enabled
    Radius Server 1..... 209.165.200.240
  Use MAC Filter in External AAA server..... disabled
  Force External Authentication..... disabled

Mesh Alarm Criteria
  Max Hop Count..... 4
  Recommended Max Children for MAP..... 10
  Recommended Max Children for RAP..... 20
  Low Link SNR..... 12
  High Link SNR..... 60
  Max Association Number..... 10
  Association Interval..... 60 minutes
  Parent Change Numbers..... 3

--More-- or (q)uit
  Parent Change Interval..... 60 minutes

Mesh Multicast Mode..... In-Out
Mesh Full Sector DFS..... enabled

Mesh Ethernet Bridging VLAN Transparent Mode..... enabled

Mesh DCA channels for Serial Backhaul APs..... disabled
```

**Step 5** Enter the **config slot slot number channel ap ap-name channel number** command to assign a particular channel to the 1524 RAP downlink radio.

- *slot number* refers to the slot of the downlink radio to which the channel is assigned.
- *ap-name* refers to the name of the access point on which the channel is configured.
- *channel number* refers to the channel that is assigned to a slot on the access point.

Slot 2 of the 1524 RAP acts as a downlink radio. If backhaul channel deselection is enabled, you can assign only those channels that are available in the DCA list the access point.

The following is a sample output:

```
(Controller) > config slot 2 channel ap Controller-RAP2-1524 136
Mesh backhaul dca-channels is enabled. Choose a channel from the DCA list.
(Controller) > config slot 2 channel ap Controller-RAP2-1524 140
```

## Backhaul Channel Deselection Guidelines

Follow these guidelines when configuring backhaul channel deselection:

- Channels for serial backhaul RAP 11a access radio and both 11a radios of serial backhaul MAPs are assigned automatically. You cannot configure these channels.
- Look out for trap logs on the controller. In case of radar detection and subsequent channel change, messages similar to below appear:

```
Channel changed for Base Radio MAC: 00:1e:bd:19:7b:00 on 802.11a
radio. Old channel: 132. New Channel: 116. Why: Radar. Energy
before/after change: 0/0. Noise before/after change: 0/0.
Interference before/after change: 0/0.
```

```
Radar signals have been detected on channel 132 by 802.11a radio
with MAC: 00:1e:bd:19:7b:00 and slot 2
```

- For every serial backhaul AP, channels on downlink and uplink radios should always be noninterfering (for example, if the uplink is channel 104, the 100, 104, and 108 channels cannot be assigned for a downlink radio on that AP). An alternate adjacent channel is also selected for an 11a access radio on RAP.
- If radar signals are detected on all channels except the uplink radio channel, the downlink radio will be shut down and the uplink radio will act as both an uplink and a downlink (that is, the behavior is similar to 1522 APs in this case).
- Radar detection is cleared after 30 minutes. Any radio that is shut down because of radar detection should be back up and operational after this duration.
- There is a 60-second silent period immediately after moving to a DFS-enabled channel (irrespective of whether the channel change is because of radar detection or user configured in case of a RAP) during which the AP scans for radar signals without transmitting anything. A small period (60 seconds) of downtime may occur because of radar detection, if the new channel is also DFS-enabled. If radar detection occurs again on the new channel during the silent period, the parent changes its channel without informing

the child AP because it is not allowed to transmit during the silent period. In this case, the child AP dissociates and goes back to scan mode, rediscovers the parent on the new channel and then joins back, which causes a slightly longer (approximately 3 minutes) downtime.

- For a RAP, the channel for the downlink radio is always selected from within the DCA list, irrespective of whether the backhaul channel deselection feature is enabled or not. The behavior is different for a MAP because the MAP can pick any channel that is allowed for that domain, unless the backhaul channel deselection feature is enabled. We recommend that you have quite a few channels added to the 802.11a DCA channel list to prevent any radios getting shut down because of a lack of channels even if the backhaul channel deselection feature is not in use.
- Because the DCA list that was used for the RRM feature is also used for mesh APs through the backhaul channel deselection feature, keep in mind that any addition or deletion of channels from the DCA list will affect the channel list input to the RRM feature for nonmesh access points as well. RRM is off for mesh.
- For -M domain APs, a slightly longer time interval (25 to 50 percent more time than usual) may be required for the mesh network to come up because there is a longer list of DFS-enabled channels in the -M domain, which each AP scans before joining the parent.

## Configuring Dynamic Channel Assignment

Using the controller GUI, follow these steps to specify the channels that the dynamic channel assignment (DCA) algorithm considers when selecting the channels to be used for RRM scanning. This functionality is helpful when you know that the clients do not support certain channels because they are legacy devices or they have certain regulatory restrictions.

The steps outlined in this section are only relevant to mesh networks.

---

### Step 1

To disable the 802.11a/n or 802.11b/g/n network, follow these steps:

- a) Choose **Wireless > 802.11a/n or 802.11b/g/n > Network** to open the 802.11a (or 802.11b/g) Global Parameters page.
- b) Deselect the **802.11a (or 802.11b/g) Network Status** check box.
- c) Click **Apply** to commit your changes.

### Step 2

Choose **Wireless > 802.11a/n or 802.11b/g/n > RRM > DCA** to open the 802.11a (or 802.11b/g) > RRM > Dynamic Channel Assignment (DCA) page.

### Step 3

Choose one of the following options from the Channel Assignment Method drop-down list to specify the controller's DCA mode:

- **Automatic**—Causes the controller to periodically evaluate and, if necessary, update the channel assignment for all joined mesh access points. This is the default value.
- **Freeze**—Causes the controller to evaluate and update the channel assignment for all joined mesh access points, if necessary, but only when you click Invoke Channel Update Once.

**Note** The controller does not evaluate and update the channel assignment immediately after you click **Invoke Channel Update Once**. It waits for the next interval to elapse.

- **OFF**—Turns off DCA and sets all mesh access point radios to the first channel of the band, which is the default value. If you choose this option, you must manually assign channels on all radios.

- Step 4** From the Interval drop-down list, choose one of the following options to specify how often the DCA algorithm is allowed to run: 10 minutes, 1 hour, 2 hours, 3 hours, 4 hours, 6 hours, 8 hours, 12 hours, or 24 hours. The default value is 10 minutes.
- Step 5** From the AnchorTime drop-down list, choose a number to specify the time of day when the DCA algorithm is to start. The options are numbers between 0 and 23 (inclusive) representing the hour of the day from 12:00 a.m. to 11:00 p.m.
- Step 6** Select the **Avoid Foreign AP Interference** check box to cause the controller's RRM algorithms to consider 802.11 traffic from foreign access points (those access points not included in your wireless network) when assigning channels to lightweight access points, or deselect it to disable this feature. For example, RRM may adjust the channel assignment to have access points avoid channels close to foreign access points. The default value is checked.
- Step 7** Select the **Avoid Cisco AP Load** check box to cause the controller's RRM algorithms to consider 802.11 traffic from Cisco lightweight access points in your wireless network when assigning channels, or deselect it to disable this feature. For example, RRM can assign better reuse patterns to access points that carry a heavier traffic load. The default value is deselected.
- Step 8** Select the **Avoid Non-802.11a (802.11b) Noise** check box to cause the controller's RRM algorithms to consider noise (non-802.11 traffic) in the channel when assigning channels to lightweight access points, or deselect it to disable this feature. For example, RRM may have access points avoid channels with significant interference from nonaccess point sources, such as microwave ovens. The default value is checked.
- Step 9** From the DCA Channel Sensitivity drop-down list, choose one of the following options to specify how sensitive the DCA algorithm is to environmental changes such as signal, load, noise, and interference when determining whether to change channels:
- **Low**—The DCA algorithm is not particularly sensitive to environmental changes.
  - **Medium**—The DCA algorithm is moderately sensitive to environmental changes.
  - **High**—The DCA algorithm is highly sensitive to environmental changes.

The default value is **Medium**.

**Table 33: DCA Sensitivity Thresholds**

Option	2.4-GHz DCA Sensitivity Threshold	5-GHz DCA Sensitivity Threshold
High	5 dB	5 dB
Medium	15 dB	20 dB
Low	30 dB	35 dB

- Step 10** For 802.11a/n networks only, choose one of the following Channel Width options to specify the channel bandwidth supported for all 802.11n radios in the 5-GHz band:
- **20 MHz**—The 20-MHz channel bandwidth (default)

**Note** To override the globally configured DCA channel width setting, you can statically configure an access point's radio for 20-MHz mode on the 802.11a/n Cisco APs > Configure page. If you ever change the static RF channel assignment method to Global on the access point radio, the global DCA configuration overrides the channel width configuration that the access point was previously using.

This page also shows the following nonconfigurable channel parameter settings:

- **Channel Assignment Leader**—The MAC address of the RF group leader, which is responsible for channel assignment.
- **Last Auto Channel Assignment**—The last time RRM evaluated the current channel assignments.

- Step 11** In the DCA Channel List section, the DCA Channels field shows the channels that are currently selected. To choose a channel, select its check box in the Select column. To exclude a channel, deselect its check box.  
**Range:** 802.11a—36, 40, 44, 48, 52, 56, 60, 64, 100, 104, 108, 112, 116, 132, 136, 140, 149, 153, 157, 161, 165, 190, 196?802.11b/g—1, 2, 3, 4, 5, 6, 7, 8, 9, 10, 11  
**Default:** 802.11a—36, 40, 44, 48, 52, 56, 60, 64, 100, 104, 108, 112, 116, 132, 136, 140, 149, 153, 157, 161?802.11b/g—1, 6, 11
- Note** These extended UNII-2 channels in the 802.11a band do not appear in the channel list: 100, 104, 108, 112, 116, 132, 136, and 140. If you have Cisco Aironet 1500 series mesh access points in the -E regulatory domain, you must include these channels in the DCA channel list before you start operation. If you are upgrading from a previous release, verify that these channels are included in the DCA channel list. To include these channels in the channel list, select the **Extended UNII-2 Channels** check box.
- Step 12** If you are using AP1500s in your network, you must set the 4.9-GHz channels in the 802.11a band on which they are to operate. The 4.9-GHz band is for public safety client access traffic only. To choose a 4.9-GHz channel, select its check box in the Select column. To exclude a channel, deselect its check box.  
**Range:** ?802.11a—1, 2, 3, 4, 5, 6, 7, 8, 9, 10, 11, 12, 13, 14, 15, 16, 17, 18, 19, 20, 21, 22, 23, 24, 25, 26  
**Default:**?802.11a—20, 26
- Step 13** Click **Apply** to commit your changes.
- Step 14** To reenble the 802.11a or 802.11b/g network, follow these steps:
- Click **Wireless > 802.11a/n** or **802.11b/g/n > Network** to open the 802.11a (or 802.11b/g) Global Parameters page.
  - Select the **802.11a** (or **802.11b/g**) **Network Status** check box.
  - Click **Apply** to commit your changes.
- Step 15** Click **Save Configuration** to save your changes.
- Note** To see why the DCA algorithm changed channels, click **Monitor** and then **View All** under Most Recent Traps. The trap provides the MAC address of the radio that changed channels, the previous channel and the new channel, the reason why the change occurred, the energy before and after the change, the noise before and after the change, and the interference before and after the change. Dynamic Channel Assignment on 5 GHz radio is supported only on outdoor access points in local or flexconnect mode.

## Configuring Advanced Features

This section includes the following topics:

- [Using the 2.4-GHz Radio for Backhaul](#)

- [Configuring Ethernet VLAN Tagging](#)
- [Workgroup Bridge Interoperability with Mesh Infrastructure](#)
- [Client Roaming](#)
- [Configuring Voice Parameters in Indoor Mesh Networks](#)
- [Enabling Mesh Multicast Containment for Video](#)

## Using the 2.4-GHz Radio for Backhaul

Until the 7.0 release, mesh used the 5-GHz radio for backhaul, and the 2.4-GHz radio was used only for client access. The reasons for using only the 5-GHz radio for backhaul are as follows:

- More channels are available
- More EIRP is available
- Less interference occurs
- Most of the client access occurs over the 2.4-GHz band

However, under certain conditions, such as dense foliage areas, you might have needed to use the 2.4-GHz band for a backhaul because it has better penetration.

With the 7.0.116.0 release, you can configure an entire mesh network to use a single backhaul that can be either 5 GHz or 2.4 GHz.



### Caution

This feature is available only for AP1522 (two radios). This feature should be used only after exploring the 5-GHz backhaul option.



### Caution

We recommend that you use 5 GHz as the first option and use 2.4 GHz only if the 5-GHz option does not work.

Changing the Backhaul from 5 GHz to 2.4 GHz

When you specify only the RAP name as an argument to the command, the whole mesh sector changes to 2.4 GHz or 5 GHz backhaul. The warning messages indicate the change in backhaul, whether it is from 2.4 GHz to 5 GHz or vice versa.



### Note

The 2.4-GHz backhaul cannot be configured using the controller user interface, but only through the CLI.

To change the backhaul from 5 GHz to 2.4 GHz, follow these steps:

**Step 1** To change the backhaul, enter the following command:

```
(Cisco Controller) > config mesh backhaul slot 0 enable RAP
```

The following message appears;

```
Warning! Changing backhaul slot will bring down the mesh for renegotiation!!!  
After backhaul is changed, 5 GHz client access channels need to be changed manually
```

```
Are you sure you want to continue? (y/N)
```

Press y.

**Note** When you change the 5-GHz backhaul to local client access, the 5-GHz client access frequencies on all the APs are the same, because the backhaul frequency is ported on these 5-GHz radios for client access. You need to configure these channels for a better frequency planning.

**Step 2** To change the backhaul from 2.4 GHz to 5 GHz, enter the following command:

```
(Cisco Controller) > config mesh backhaul slot 1 enable RAP
```

The following message appears:

```
Warning! Changing backhaul slot will bring down the mesh for renegotiation!!!  
Are you sure you want to continue? (y/N)
```

Press y.

**Note** You cannot configure the 2.4-GHz backhaul using the controller GUI, but you can configure the 2.4-GHz backhaul using the CLI.

**Step 3** To verify the current backhaul in use, enter the following command:

```
(Cisco Controller) > show mesh backhaul AP_name
```

**Note** For a 5-GHz backhaul, dynamic frequency selection (DFS) occurs only on 5 GHz and not on 2.4 GHz. The mechanism, which differs for RAP and MAP, is called a coordinated change mechanism. When 5 GHz is converted to client access from the backhaul or 2.4 GHz is being used as backhaul, DFS works similar to how it works for a local mode AP. DFS is detected on a 5-GHz client access, and the request is sent to the controller for a new channel. Mesh adjacency is not affected for the 2.4-GHz backhaul.

**Note** 2.4 GHz backhaul client access is supported only on 1520 series Access Points.

---

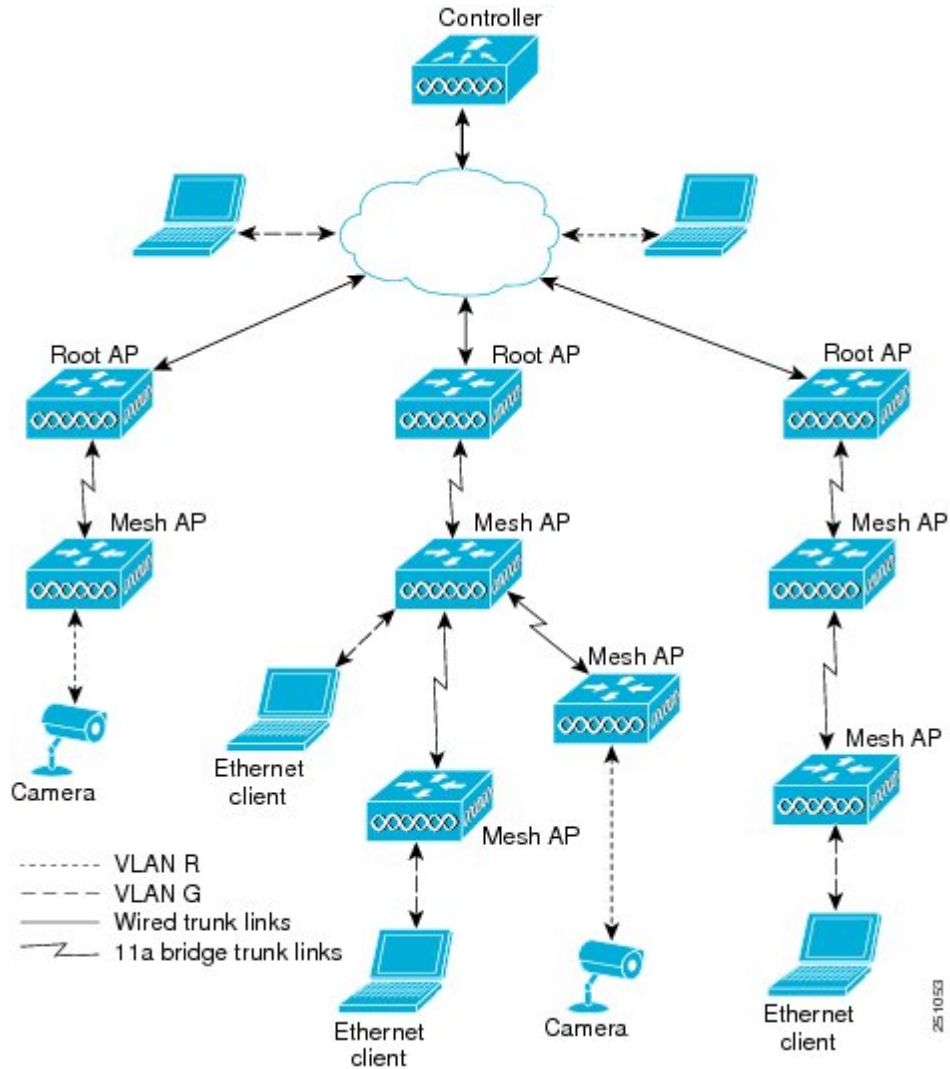
## Configuring Ethernet VLAN Tagging

Ethernet VLAN tagging allows specific application traffic to be segmented within a wireless mesh network and then forwarded (bridged) to a wired LAN (access mode) or bridged to another wireless mesh network (trunk mode).

A typical public safety access application that uses Ethernet VLAN tagging is the placement of video surveillance cameras at various outdoor locations within a city. Each of these video cameras has a wired

connection to a MAP. The video of all these cameras is then streamed across the wireless backhaul to a central command station on a wired network.

**Figure 63: Ethernet VLAN Tagging**



## Ethernet Port Notes

Ethernet VLAN tagging allows Ethernet ports to be configured as normal, access, or trunk in both indoor and outdoor implementations:



**Note**

When VLAN Transparent is disabled, the default Ethernet port mode is normal. VLAN Transparent must be disabled for VLAN tagging to operate and to allow configuration of Ethernet ports. To disable VLAN Transparent, which is a global parameter, see the Configuring Global Mesh Parameters section.

- **Normal mode**—In this mode, the Ethernet port does not accept or send any tagged packets. Tagged frames from clients are dropped.

Use the normal mode in applications when only a single VLAN is in use or there is no need to segment traffic in the network across multiple VLANs.

- **Access Mode**—In this mode, only untagged packets are accepted. All incoming packets are tagged with user-configured VLANs called access-VLANs.

Use the access mode for applications in which information is collected from devices connected to the MAP, such as cameras or PCs, and then forwarded to the RAP. The RAP then applies tags and forwards traffic to a switch on the wired network.

- **Trunk mode**—This mode requires the user to configure a native VLAN and an allowed VLAN list (no defaults). In this mode, both tagged and untagged packets are accepted. Untagged packets are accepted and are tagged with the user-specified native VLAN. Tagged packets are accepted if they are tagged with a VLAN in the allowed VLAN list.
- Use the trunk mode for bridging applications such as forwarding traffic between two MAPs that reside on separate buildings within a campus.

---

Ethernet VLAN tagging operates on Ethernet ports that are not used as backhauls.

**Note**

In the controller releases prior to 7.2, the Root Access Point (RAP) native VLAN is forwarded out of Mesh Access Point (MAP) Ethernet ports with Mesh Ethernet Bridging and VLAN Transparent enabled.

In the 7.2 and later controller releases, the Root Access Point (RAP) native VLAN is not forwarded out of Mesh Access Point (MAP) Ethernet ports with Mesh Ethernet Bridging and VLAN Transparent enabled.

This change in behavior increases reliability and minimizes the possibility of forwarding loops on Mesh Backhauls.

## Ethernet VLAN Tagging Guidelines

Follow these guidelines for Ethernet tagging:

- For security reasons, the Ethernet port on a mesh access point (RAP and MAP) is disabled by default. It is enabled by configuring Ethernet bridging on the mesh access point port.
- Ethernet bridging must be enabled on all the mesh access points in the mesh network to allow Ethernet VLAN tagging to operate.
- VLAN mode must be set as non-VLAN transparent (global mesh parameter). See the Configuring Global Mesh Parameters (CLI) section. VLAN transparent is enabled by default. To set as non-VLAN transparent, you must unselect the VLAN transparent option on the Wireless > Mesh page.
- VLAN tagging can only be configured on Ethernet interfaces as follows:

- On AP1500s, three of the four ports can be used as secondary Ethernet interfaces: port 0-PoE in, port 1-PoE out, and port 3- fiber. Port 2 - cable cannot be configured as a secondary Ethernet interface.
- In Ethernet VLAN tagging, port 0-PoE in on the RAP is used to connect to the trunk port of the switch of the wired network. Port 1-PoE out on the MAP is used to connect to external devices such as video cameras.
- Backhaul interfaces (802.11a radios) act as primary Ethernet interfaces. Backhauls function as trunks in the network and carry all VLAN traffic between the wireless and wired network. No configuration of primary Ethernet interfaces is required.
- For indoor mesh networks, the VLAN tagging feature functions as it does for outdoor mesh networks. Any access port that is not acting as a backhaul is *secondary* and can be used for VLAN tagging.
- VLAN tagging cannot be implemented on RAPs because the RAPs do not have a secondary Ethernet port, and the primary port is used as a backhaul. However, VLAN tagging can be enabled on MAPs with a single Ethernet port because the Ethernet port on a MAP does not function as a backhaul and is therefore a secondary port.
- No configuration changes are applied to any Ethernet interface acting as a backhaul. A warning displays if you attempt to modify the backhaul's configuration. The configuration is only applied after the interface is no longer acting as a backhaul.
- No configuration is required to support VLAN tagging on any 802.11a backhaul Ethernet interface within the mesh network as follows:
  - This includes the RAP uplink Ethernet port. The required configuration occurs automatically using a registration mechanism.
  - Any configuration changes to an 802.11a Ethernet link acting as a backhaul are ignored and a warning results. When the Ethernet link no longer functions as a backhaul, the modified configuration is applied.
- VLAN configuration is not allowed on port-02-cable modem port of AP1500s (wherever applicable). VLANs can be configured on ports 0 (PoE-in), 1 (PoE-out), and 3 (fiber).
- Up to 16 VLANs are supported on each sector. The cumulative number of VLANs supported by a RAP's children (MAP) cannot exceed 16.
- The switch port connected to the RAP must be a trunk:
  - The trunk port on the switch and the RAP trunk port must match.
  - The RAP must always connect to the native VLAN ID 1 on a switch. The RAP's primary Ethernet interface is by default the native VLAN of 1.
  - The switch port in the wired network that is attached to the RAP (port 0-PoE in) must be configured to accept tagged packets on its trunk port. The RAP forwards all tagged packets received from the mesh network to the wired network.
  - No VLANs, other than those destined for the mesh sector, should be configured on the switch trunk port.
- A configured VLAN on a MAP Ethernet port cannot function as a Management VLAN.

- Configuration is effective only when a mesh access point is in the CAPWAP RUN state and VLAN-Transparent mode is disabled.
- Whenever there roaming or a CAPWAP restart, an attempt is made to apply configuration again.

## VLAN Registration

To support a VLAN on a mesh access point, all the uplink mesh access points must also support the same VLAN to allow segregation of traffic that belongs to different VLANs. The activity by which a mesh access point communicates its requirements for a VLAN and gets response from a parent is known as VLAN registration.

**Note**

VLAN registration occurs automatically. No user intervention is required.

VLAN registration is summarized below:

- 1 Whenever an Ethernet port on a mesh access point is configured with a VLAN, the port requests its parent to support that VLAN.
- 2 If the parent is able to support the request, it creates a bridge group for the VLAN and propagates the request to its parent. This propagation continues until the RAP is reached.
- 3 When the request reaches the RAP, it checks whether it is able to support the VLAN request. If yes, the RAP creates a bridge group and a subinterface on its uplink Ethernet interface to support the VLAN request.
- 4 If the mesh access point is not able to support the VLAN request by its child, at any point, the mesh access point replies with a negative response. This response is propagated to downstream mesh access points until the mesh access point that requested the VLAN is reached.
- 5 Upon receiving negative response from its parent, the requesting mesh access point defers the configuration of the VLAN. However, the configuration is stored for future attempts. Given the dynamic nature of mesh, another parent and its uplink mesh access points might be able to support it in the case of roaming or a CAPWAP reconnect.

## Enabling Ethernet VLAN Tagging (GUI)

You must enable Ethernet bridging before you can configure VLAN tagging.

To enable VLAN tagging on a RAP or MAP using the GUI, follow these steps:

- 
- Step 1** After enabling Ethernet bridging, choose **Wireless > All APs**.
- Step 2** Click the AP name link of the mesh access point on which you want to enable VLAN tagging.
- Step 3** On the details page, select the **Mesh** tab.
- Step 4** Select the **Ethernet Bridging** check box to enable the feature and click **Apply**.  
An Ethernet Bridging section appears at the bottom of the page listing each of the four Ethernet ports of the mesh access point.
- If configuring a MAP *access* port, click, for example, **gigabitEthernet1** (port 1-PoE out).

Select **access** from the mode drop-down list.

Enter a VLAN ID. The VLAN ID can be any value between 1 and 4095.

Click **Apply**.

**Note** VLAN ID 1 is not reserved as the default VLAN.

**Note** A maximum of 16 VLANs are supported across all of a RAP's subordinate MAP.

- If configuring a RAP or MAP *trunk* port, click **gigabitEthernet0** (port 0-PoE in).

Select **trunk** from the mode drop-down list.

Specify a native VLAN ID for *incoming* traffic. The native VLAN ID can be any value between 1 and 4095. Do not assign any value assigned to a user-VLAN (access).

Click **Apply**.

A trunk VLAN ID field and a summary of configured VLANs appears at the bottom of the screen. The trunk VLAN ID field is for outgoing packets.

Specify a trunk VLAN ID for *outgoing* packets:

If forwarding *untagged* packets, do not change the default trunk VLAN ID value of zero. (MAP-to-MAP bridging, campus environment)

If forwarding *tagged* packets, enter a VLAN ID (1 to 4095) that is not already assigned. (RAP to switch on wired network).

Click **Add** to add the trunk VLAN ID to the allowed VLAN list. The newly added VLAN displays under the Configured VLANs section on the page.

**Note** To remove a VLAN from the list, select the Remove option from the arrow drop-down list to the right of the desired VLAN.

**Step 5** Click **Apply**.

**Step 6** Click **Save Configuration** to save your changes.

## Configuring Ethernet VLAN Tagging (CLI)

To configure a MAP *access* port, enter this command:

```
config ap ethernet 1 mode access enable AP1500-MAP 50
```

where *AP1500-MAP* is the variable *AP\_name* and *50* is the variable *access\_vlan ID*

To configure a RAP or MAP *trunk* port, enter this command:

```
config ap ethernet 0 mode trunk enable AP1500-MAP 60
```

where *AP1500-MAP* is the variable *AP\_name* and *60* is the variable *native\_vlan ID*

To add a VLAN to the VLAN allowed list of the native VLAN, enter this command:

```
config ap ethernet 0 mode trunk add AP1500-MAP3 65
```

where *AP1500-MAP 3* is the variable *AP\_name* and *65* is the variable *VLAN ID*

## Viewing Ethernet VLAN Tagging Configuration Details (CLI)

- To view VLAN configuration details for Ethernet interfaces on a specific mesh access point (*AP Name*) or all mesh access points (*summary*), enter this command:  
**show ap config ethernet *ap-name***
- To see if VLAN transparent mode is enabled or disabled, enter this command:  
**show mesh config**

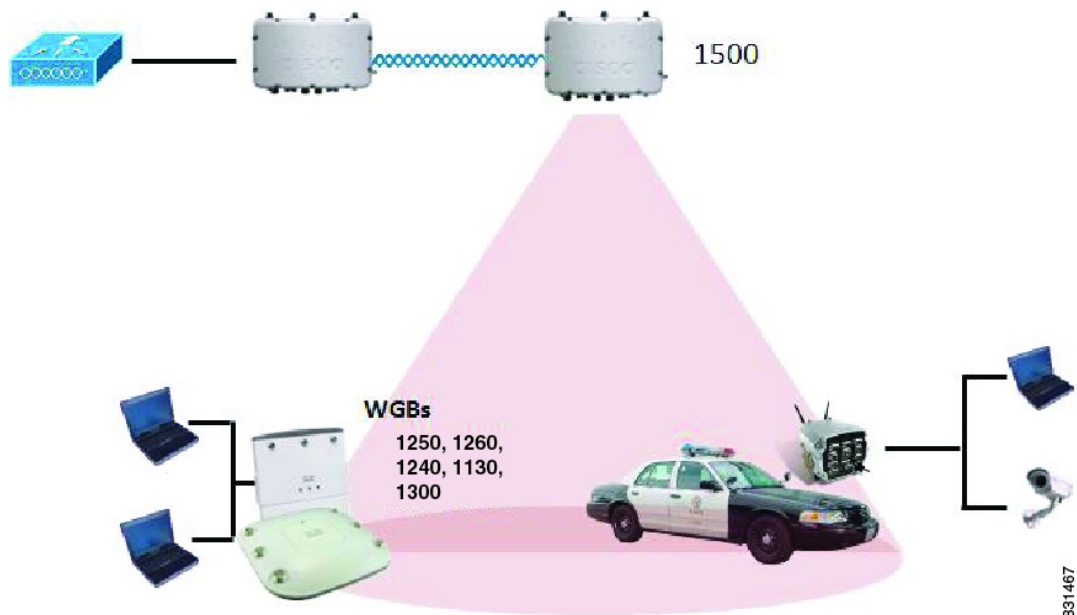
## Workgroup Bridge Interoperability with Mesh Infrastructure

A workgroup bridge (WGB) is a small standalone unit that can provide a wireless infrastructure connection for Ethernet-enabled devices. Devices that do not have a wireless client adapter to connect to the wireless network can be connected to the WGB through the Ethernet port. The WGB is associated with the root AP through the wireless interface, which means that wired clients get access to the wireless network.

A WGB is used to connect wired networks over a single wireless segment by informing the mesh access point of all the clients that the WGB has on its wired segment via IAPP messages. The data packets for WGB clients contain an additional MAC address in the 802.11 header (4 MAC headers, versus the normal 3 MAC data headers). The additional MAC in the header is the address of the WGB itself. This additional MAC address is used to route the packet to and from the clients.

WGB association is supported on all radios of every mesh access point.

**Figure 64: WGB Example**



In the current architecture, while an autonomous AP functions as a workgroup bridge, only one radio interface is used for controller connectivity, Ethernet interface for wired client connectivity, and other radio interface for wireless client connectivity. dot11radio 1 (5 GHz) can be used to connect to a controller (using the mesh infrastructure) and Ethernet interface for wired clients. dot11radio 0 (2.4 GHz) can be used for wireless client

connectivity. Depending on the requirement, dot11radio 1 or dot11radio 0 can be used for client association or controller connectivity.

With the 7.0 release, a wireless client on the second radio of the WGB is not dissociated by the WGB upon losing its uplink to a wireless infrastructure or in a roaming scenario.

With two radios, one radio can be used for client access and the other radio can be used for accessing the access points. Having two independent radios performing two independent functions provides you better control and lowers the latency. Also, wireless clients on the second radio for the WGB do not get disassociated by the WGB when an uplink is lost or in a roaming scenario. One radio has to be configured as a Root AP (radio role) and the second radio has to be configured as a WGB (radio role).

**Note**

If one radio is configured as a WGB, then the second radio cannot be a WGB or a repeater.

The following features are not supported for use with a WGB:

- Idle timeout
- Web authentication—If a WGB associates to a web-authentication WLAN, the WGB is added to the exclusion list, and all of the WGB-wired clients are deleted (web-authentication WLAN is another name for a guest WLAN).
- For wired clients behind the WGB, MAC filtering, link tests, and idle timeout

## Configuring Workgroup Bridges

A workgroup bridge (WGB) is used to connect wired networks over a single wireless segment by informing the mesh access point of all the clients that the WGB has on its wired segment via IAPP messages. In addition to the IAPP control messages, the data packets for WGB clients contain an extra MAC address in the 802.11 header (4 MAC headers, versus the normal 3 MAC data headers). The extra MAC in the header is the address of the workgroup bridge itself. This extra MAC address is used to route the packet to and from the clients.

WGB association is supported on both the 2.4-GHz (802.11b/g) and 5-GHz (802.11a) radios on the AP1522, and the 2.4-GHz (802.11b) and 4.9-GHz (public safety) radios on the AP1524PS;

Supported platforms are autonomous WGBs AP1130, AP1240, AP1310, and the Cisco 3200 Mobile Router (*hereafter* referred to as Cisco 3200) which are configured as WGBs can associate with a mesh access point. See the “Cisco Workgroup Bridges” section in *Cisco Wireless LAN Controller Configuration Guide* for configuration steps at [http://www.cisco.com/en/US/products/ps6366/products\\_installation\\_and\\_configuration\\_guides\\_list.html](http://www.cisco.com/en/US/products/ps6366/products_installation_and_configuration_guides_list.html)

The supported WGB modes and capacities are as follows:

- The autonomous access points configured as WGBs must be running Cisco IOS release 12.4.25d-JA or later.

**Note**

If your mesh access point has two radios, you can only configure workgroup bridge mode on one of the radios. We recommend that you disable the second radio. Workgroup bridge mode is not supported on access points with three radios such as the AP1524SB.

- Client mode WGB (BSS) is supported; however, infrastructure WGB is not supported. The client mode WGB is not able to trunk VLAN as in an infrastructure WGB.

- Multicast traffic is not reliably transmitted to WGB because no ACKs are returned by the client. Multicast traffic is unicast to infrastructure WGB, and ACKs are received back.
- If one radio is configured as a WGB in a Cisco IOS access point, then the second radio cannot be a WGB or a repeater.
- Mesh access points can support up to 200 clients including wireless clients, WGB, and wired clients behind the associated WGB.
- A WGB cannot associate with mesh access points if the WLAN is configured with WPA1 (TKIP) +WPA2 (AES), and the corresponding WGB interface is configured with only one of these encryptions (either WPA1 or WPA2):

Figure 65: WPA Security Settings for a WGB

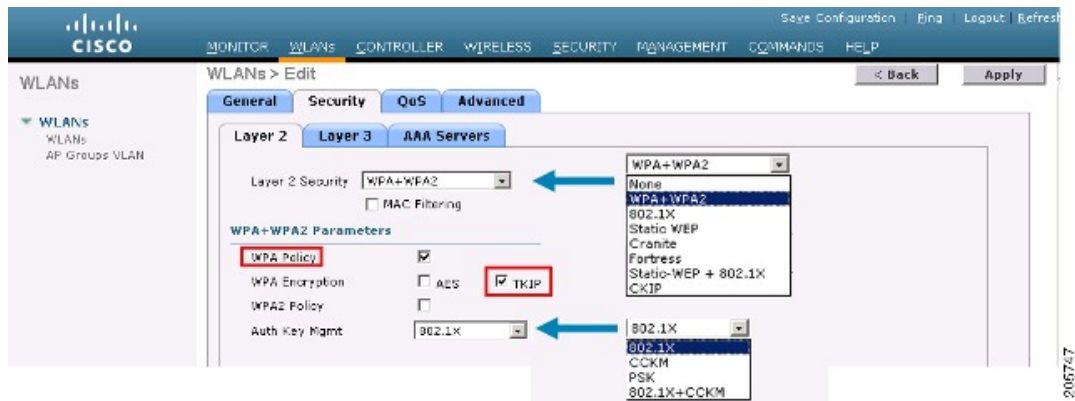
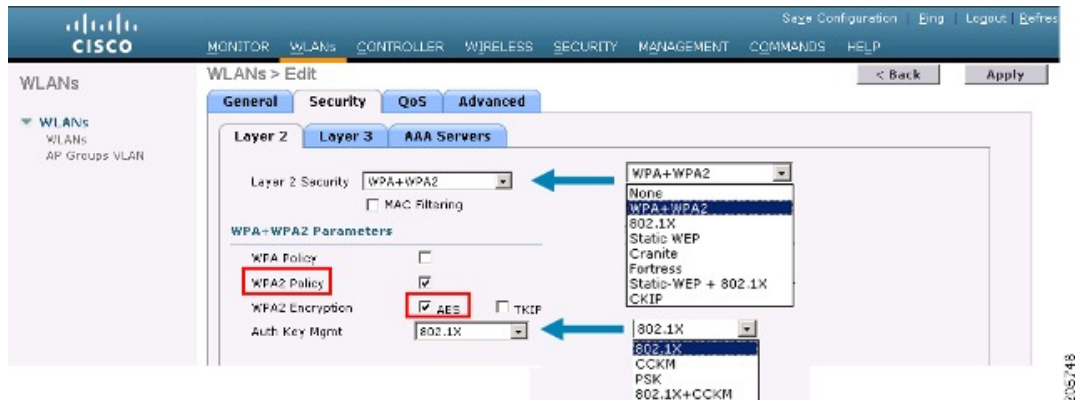


Figure 66: WPA-2 Security Settings for a WGB



To view the status of a WGB client, follow these steps:

- Step 1** Choose **Monitor > Clients**.
- Step 2** On the client summary page, click on the MAC address of the client or search for the client using its MAC address.
- Step 3** In the page that appears, note that the client type is identified as a *WGB* (far right).

**Figure 67: Clients are Identified as a WGB**



Client MAC Addr	AP Name	WLAN Profile	Protocol	Status	Auth	Port	WGB
<a href="#">00:05:3a:12f:57:36</a>	SkyRep-70:7b:a0	WLAN5	802.11g	Associated	Yes	29	Yes
<a href="#">00:06:98:fe:09:94</a>	SkyRep-70:7b:a0	WLAN5	802.11b	Associated	Yes	29	No
<a href="#">00:13:a0:d3:95:c2</a>	RAP001b.2426-F092-1130	Unknown	802.11a	Probing	No	29	No
<a href="#">00:15:5d:44:25:ed</a>	RAP001a.1449.1400Plus	WLAN5	802.11a	Associated	Yes	29	No
<a href="#">00:16:36:5f:4b:74</a>	MAP2-001e.1448.ec00H3r	WLAN5	802.11a	Associated	Yes	29	No

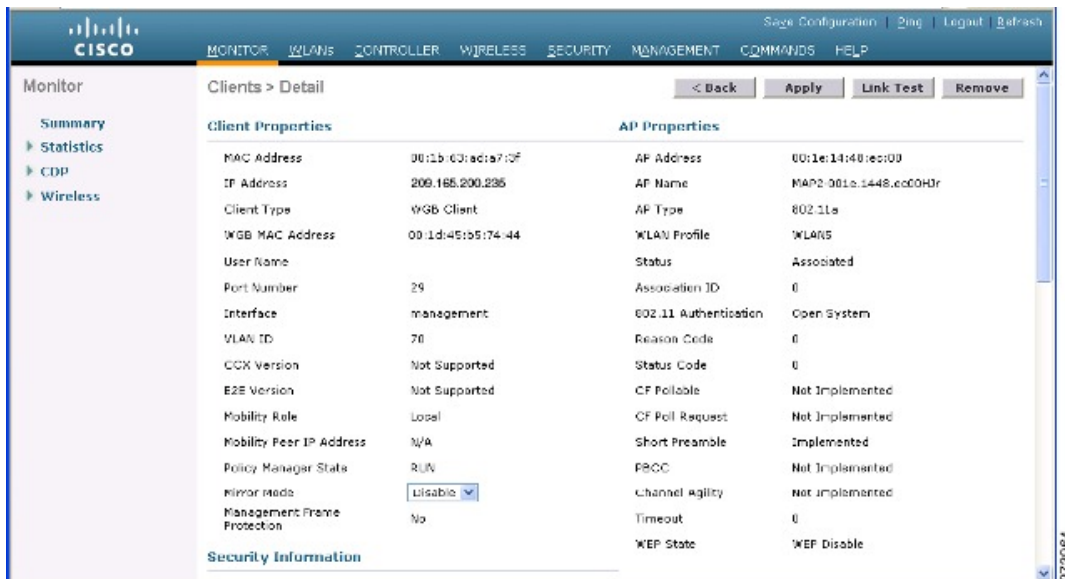
- Step 4** Click on the MAC address of the client to view configuration details:

- For a wireless client, the page seen in [Figure 68: Monitor > Clients > Detail Page \(Wireless WGB Client\)](#), on page 165 appears.

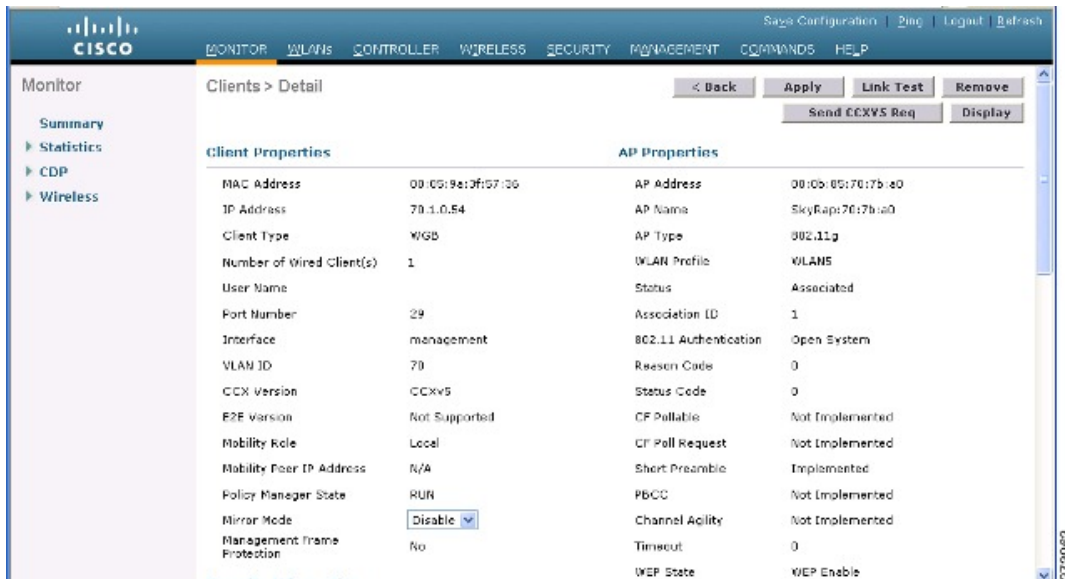


- For a wired client, the page seen in [Figure 69: Monitor > Clients > Detail Page \(Wired WGB Client\)](#), on page 165 appears.

**Figure 68: Monitor > Clients > Detail Page (Wireless WGB Client)**



**Figure 69: Monitor > Clients > Detail Page (Wired WGB Client)**



## Guidelines for Configuration

Follow these guidelines when you configure:

- We recommend using a 5-GHz radio for the uplink to Mesh AP infrastructure so you can take advantage of a strong client access on two 5-GHz radios available on mesh access points. A 5-GHz band allows more Effective Isotropic Radiated Power (EIRP) and is less polluted. In a two-radio WGB, configure 5-GHz radio (radio 1) mode as WGB. This radio will be used to access the mesh infrastructure. Configure the second radio 2.4-GHz (radio 0) mode as Root for client access.
- On the Autonomous access points, only one SSID can be assigned to the native VLAN. You cannot have multiple VLANs in one SSID on the autonomous side. SSID to VLAN mapping should be unique because this is the way to segregate traffic on different VLANs. In a unified architecture, multiple VLANs can be assigned to one WLAN (SSID).
- Only one WLAN (SSID) for wireless association of the WGB to the access point infrastructure is supported. This SSID should be configured as an infrastructure SSID and should be mapped to the native VLAN.
- A dynamic interface should be created in the controller for each VLAN configured in the WGB.
- A second radio (2.4-GHz) on the access point should be configured for client access. You have to use the same SSID on both radios and map to the native VLAN. If you create a separate SSID, then it is not possible to map it to a native VLAN, due to the unique VLAN/SSID mapping requirements. If you try to map the SSID to another VLAN, then you do not have multiple VLAN support for wireless clients.
- All Layer 2 security types are supported for the WLANs (SSIDs) for wireless client association in WGB.
- This feature does not depend on the AP platform. On the controller side, both mesh and nonmesh APs are supported.
- There is a limitation of 20 clients in the WGB. The 20-client limitation includes both wired and wireless clients. If the WGB is talking to autonomous access points, then the client limit is very high.
- The controller treats the wireless and wired clients behind a WGB in the same manner. Features such as MAC filtering and link test are not supported for wireless WGB clients from the controller.
- If required, you can run link tests for a WGB wireless client from an autonomous AP.
- Multiple VLANs for wireless clients associated to a WGB are not supported.
- Up to 16 multiple VLANs are supported for wired clients behind a WGB from the 7.0 release and later releases.
- Roaming is supported for wireless and wired clients behind a WGB. The wireless clients on the other radio will not be dissociated by the WGB when an uplink is lost or in a roaming scenario.

We recommend that you configure radio 0 (2.4 GHz) as a Root (one of the mode of operations for Autonomous AP) and radio 1 (5 GHz) as a WGB.

## Configuration Example

When you configure from the CLI, the following are mandatory:

- dot11 SSID (security for a WLAN can be decided based on the requirement).
- Map the subinterfaces in both the radios to a single bridge group.

**Note**

A native VLAN is always mapped to bridge group 1 by default. For other VLANs, the bridge group number matches the VLAN number; for example, for VLAN 46, the bridge group is 46.

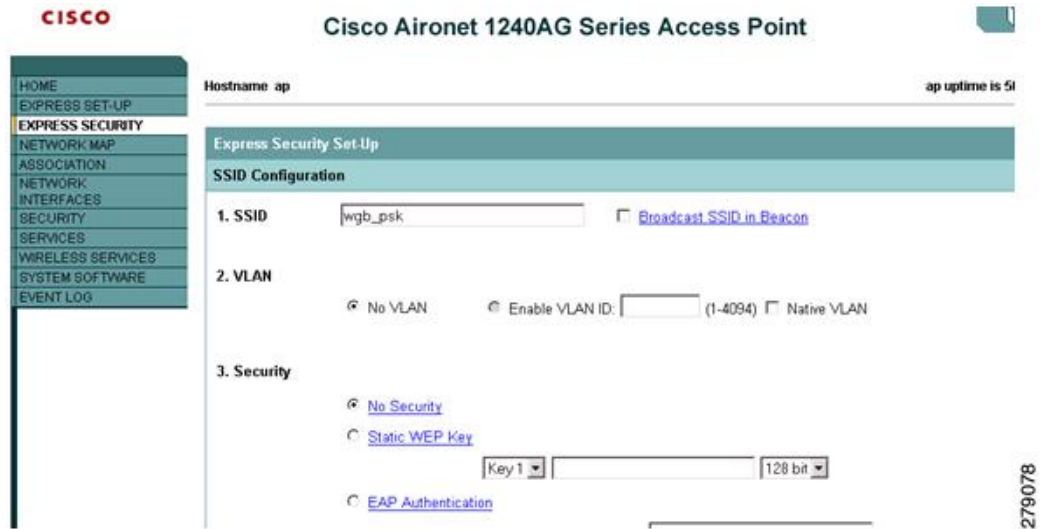
- Map the SSID to the radio interfaces and define the role of the radio interfaces.

In the following example, one SSID (WGBTEST) is used in both radios, and the SSID is the infrastructure SSID mapped to NATIVE VLAN 51. All radio interfaces are mapped to bridge group -1.

```
WGB1#config t
WGB1 (config) #interface Dot11Radio1.51
WGB1 (config-subif) #encapsulation dot1q 51 native
WGB1 (config-subif) #bridge-group 1
WGB1 (config-subif) #exit
WGB1 (config) #interface Dot11Radio0.51
WGB1 (config-subif) #encapsulation dot1q 51 native
WGB1 (config-subif) #bridge-group 1
WGB1 (config-subif) #exit
WGB1 (config) #dot11 ssid WGBTEST
WGB1 (config-ssid) #VLAN 51
WGB1 (config-ssid) #authentication open
WGB1 (config-ssid) #infrastructure-ssid
WGB1 (config-ssid) #exit
WGB1 (config) #interface Dot11Radio1
WGB1 (config-if) #ssid WGBTEST
WGB1 (config-if) #station-role workgroup-bridge
WGB1 (config-if) #exit
WGB1 (config) #interface Dot11Radio0
WGB1 (config-if) #ssid WGBTEST
WGB1 (config-if) #station-role root
WGB1 (config-if) #exit
```

You can also use the GUI of an autonomous AP for configuration. From the GUI, subinterfaces are automatically created after the VLAN is defined.

**Figure 70: SSID Configuration Page**



## WGB Association Check

Both the WGB association to the controller and the wireless client association to WGB can be verified by entering the **show dot11 associations client** command in autonomous AP.

WGB#**show dot11 associations client**

802.11 Client Stations on Dot11Radio1:

SSID [WGBTEST] :

MAC Address	IP Address	Device	Name	Parent	State
0024.130f.920e	209.165.200.225	LWAPP-Parent	RAPSB	-	Assoc

From the controller, choose **Monitor > Clients**. The WGB and the wireless/wired client behind the WGB are updated and the wireless/wired client are shown as the WGB client.

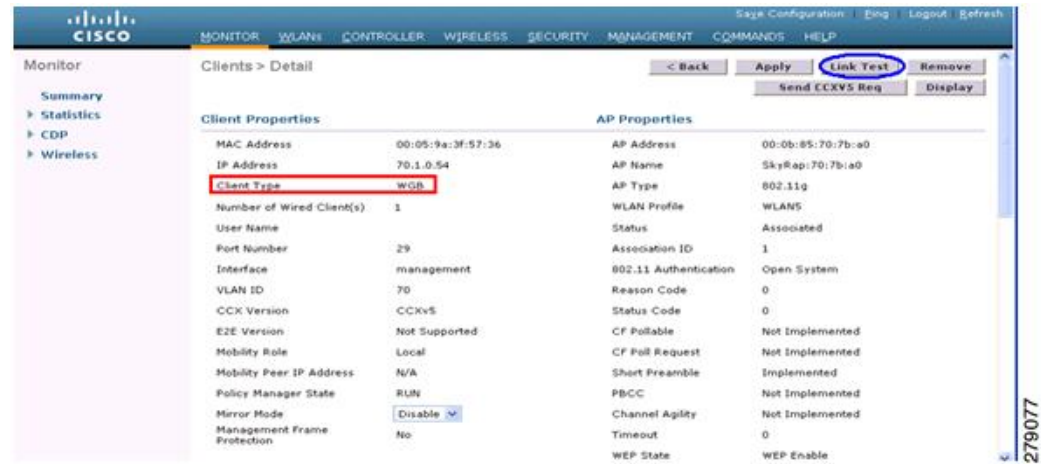
Figure 71: Updated WGB Clients



Figure 72: Updated WGB Clients

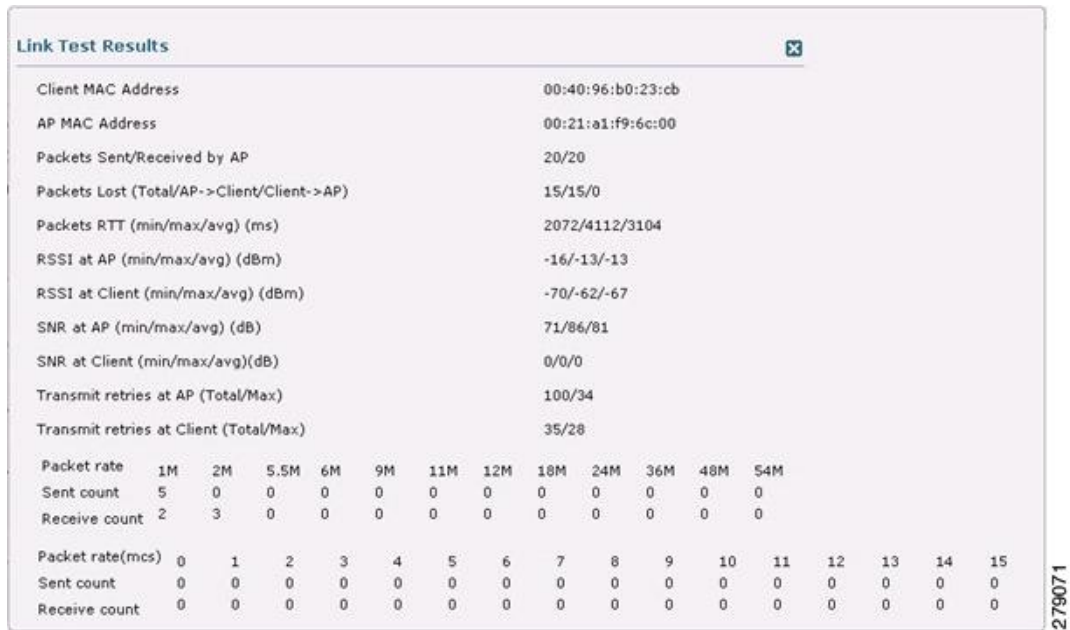


Figure 73: Updated WGB Clients



## Link Test Result

Figure 74: Link Test Results



A link test can also be run from the controller CLI using the following command:

(Cisco Controller) > **linktest client** *mac-address*

Link tests from the controller are only limited to the WGB, and they cannot be run beyond the WGB from the controller to a wired or wireless client connected to the WGB. You can run link tests for the wireless client connected to the WGB from the WGB itself using the following command:

```
ap#dot11 dot11Radio 0 linktest target client-mac-address
Start linktest to 0040.96b8.d462, 100 512 byte packets
ap#
```

POOR (4% lost)	Time (msec)	Strength (dBm)		SNR Quality		Retries	
		In	Out	In	Out	In	Out
Sent: 100	Avg. 22	-37	-83	48	3	Tot. 34	35
Lost to Tgt: 4	Max. 112	-34	-78	61	10	Max. 10	5
Lost to Src: 4	Min. 0	-40	-87	15	3		

```
Rates (Src/Tgt)      24Mb 0/5  36Mb 25/0  48Mb 73/0  54Mb 2/91
Linktest Done in 24.464 msec
```

## WGB Wired/Wireless Client

You can also use the following commands to know the summary of WGBs and clients associated with a Cisco lightweight access point:

```
(Cisco Controller) > show wgb summary
```

```
Number of WGBs..... 2
```

MAC Address	IP Address	AP Name	Status	WLAN	Auth	Protocol	Clients
00:1d:70:97:bd:e8	209.165.200.225	c1240	Assoc	2	Yes	802.11a	2
00:1e:be:27:5f:e2	209.165.200.226	c1240	Assoc	2	Yes	802.11a	5

```
(Cisco Controller) > show client summary
```

```
Number of Clients..... 7
```

MAC Address	AP Name	Status	WLAN/Guest-Lan	Auth	Protocol	Port	Wired
00:00:24:ca:a9:b4	R14	Associated	1	Yes	N/A	29	No
00:24:c4:a0:61:3a	R14	Associated	1	Yes	802.11a	29	No
00:24:c4:a0:61:f4	R14	Associated	1	Yes	802.11a	29	No
00:24:c4:a0:61:f8	R14	Associated	1	Yes	802.11a	29	No
00:24:c4:a0:62:0a	R14	Associated	1	Yes	802.11a	29	No
00:24:c4:a0:62:42	R14	Associated	1	Yes	802.11a	29	No
00:24:c4:a0:71:d2	R14	Associated	1	Yes	802.11a	29	No

```
(Cisco Controller) > show wgb detail 00:1e:be:27:5f:e2
```

Number of wired client(s): 5

MAC Address	IP Address	AP Name	Mobility	WLAN	Auth
00:16:c7:5d:b4:8f	Unknown	c1240	Local	2	No
00:21:91:f8:e9:ae	209.165.200.232	c1240	Local	2	Yes
00:21:55:04:07:b5	209.165.200.234	c1240	Local	2	Yes
00:1e:58:31:c7:4a	209.165.200.236	c1240	Local	2	Yes
00:23:04:9a:0b:12	Unknown	c1240	Local	2	No

## Client Roaming

High-speed roaming of Cisco Compatible Extension (CX), version 4 (v4) clients is supported at speeds up to 70 miles per hour in outdoor mesh deployments of AP1522s and AP1524s. An example application might be maintaining communication with a terminal in an emergency vehicle as it moves within a mesh public network.

Three Cisco CX v4 Layer 2 client roaming enhancements are supported:

- Access point assisted roaming—Helps clients save scanning time. When a Cisco CX v4 client associates to an access point, it sends an information packet to the new access point listing the characteristics of its previous access point. Roaming time decreases when the client recognizes and uses an access point list built by compiling all previous access points to which each client was associated and sent (unicast) to the client immediately after association. The access point list contains the channels, BSSIDs of neighbor access points that support the client's current SSID(s), and time elapsed since disassociation.
- Enhanced neighbor list—Focuses on improving a Cisco CX v4 client's roam experience and network edge performance, especially when servicing voice applications. The access point provides its associated client information about its neighbors using a neighbor-list update unicast message.
- Roam reason report—Enables Cisco CX v4 clients to report the reason why they roamed to a new access point. It also allows network administrators to build and monitor a roam history.



**Note** Client roaming is enabled by default. For more information, see the Enterprise Mobility Design Guide at <http://www.cisco.com/en/US/docs/solutions/Enterprise/Mobility/emob41dg/eMob4.1.pdf>

## WGB Roaming Guidelines

Follow these guidelines for WGB roaming:

- Configuring a WGB for roaming—If a WGB is mobile, you can configure it to scan for a better radio connection to a parent access point or bridge. Use the `ap(config-if)#mobile station period 3 threshold 50` command to configure the workgroup bridge as a mobile station.



When you enable this setting, the WGB scans for a new parent association when it encounters a poor Received Signal Strength Indicator (RSSI), excessive radio interference, or a high frame-loss percentage. Using these criteria, a WGB configured as a mobile station searches for a new parent association and roams to a new parent before it loses its current association. When the mobile station setting is disabled (the default setting), a WGB does not search for a new association until it loses its current association.

- **Configuring a WGB for Limited Channel Scanning**—In mobile environments such as railroads, a WGB instead of scanning all the channels is restricted to scan only a set of limited channels to reduce the hand-off delay when the WGB roams from one access point to another. By limiting the number of channels, the WGB scans only those required channels; the mobile WGB achieves and maintains a continuous wireless LAN connection with fast and smooth roaming. This limited channel set is configured using the `ap(config-if)#mobile station scan set of channels`.

This command invokes scanning to all or specified channels. There is no limitation on the maximum number of channels that can be configured. The maximum number of channels that can be configured is restricted only by the number of channels that a radio can support. When executed, the WGB scans only this limited channel set. This limited channel feature also affects the known channel list that the WGB receives from the access point to which it is currently associated. Channels are added to the known channel list only if they are also part of the limited channel set.

## Configuration Example

The following example shows how to configure a roaming configuration:

```
ap(config)#interface dot11radio 1
ap(config-if)#ssid outside
ap(config-if)#packet retries 16
ap(config-if)#station role workgroup-bridge
ap(config-if)#mobile station
ap(config-if)#mobile station period 3 threshold 50
ap(config-if)#mobile station scan 5745 5765
```

Use the **no mobile station scan** command to restore scanning to all the channels.

[Table 34: WGB Interoperability Chart, on page 173](#) identifies mesh access points and their respective frequency bands that support WGB.

**Table 34: WGB Interoperability Chart**

RAP/MAP	WGB								
Backhaul	MAR3200			802.11n Indoor APs		1130/1240		1310	
	4.9 GHz (5, 10, 20 MHz)	5 GHz	2.4 GHz	5 GHz	2.4 GHz	5 GHz	2.4 GHz	5 GHz	2.4 GHz
1552/1552	No	Yes	Yes	Yes	Yes	Yes	Yes	No	Yes
1524SB/1524SB	No	Yes	Yes	Yes	Yes	Yes	Yes	No	Yes

RAP/MAP	WGB								
	Yes	No	Yes	No	Yes	No	Yes	No	Yes
1524PS/1524PS	Yes	No	Yes	No	Yes	No	Yes	No	Yes
1522/1522	Yes	Yes	Yes	Yes	Yes	Yes	Yes	No	Yes
1524SB/1522	No	Yes	Yes	Yes	Yes	Yes	Yes	No	Yes
1524PS/1522	No	Yes	Yes	Yes	Yes	Yes	Yes	No	Yes
1522/1524SB	No	Yes	Yes	Yes	Yes	Yes	Yes	No	Yes
1522/1524PS	Yes	No	Yes	No	Yes	No	Yes	No	Yes
1240/1130	No	Yes	Yes	Yes	Yes	Yes	Yes	No	Yes

## Troubleshooting Tips

If a wireless client is not associated with a WGB, use the following steps to troubleshoot the problem:

- 1 Verify the client configuration and ensure that the client configuration is correct.
- 2 Check the **show bridge** command output in autonomous AP, and confirm that the AP is reading the client MAC address from the right interface.
- 3 Confirm that the subinterfaces corresponding to specific VLANs in different interfaces are mapped to the same bridge group.
- 4 If required, clear the bridge entry using the **clear bridge** command (remember that this command will remove all wired and wireless clients associated in a WGB and make them associate again).
- 5 Check the **show dot11 association** command output and confirm that the WGB is associated with the controller.
- 6 Ensure that the WGB has not exceeded its 20-client limitation.

In a normal scenario, if the **show bridge** and **show dot11 association** command outputs are as expected, wireless client association should be successful.

## Configuring Voice Parameters in Indoor Mesh Networks

You can configure call admission control (CAC) and QoS on the controller to manage voice and video quality on the mesh network.

The indoor mesh access points are 802.11e capable, and QoS is supported on the local 2.4-GHz access radio and the 5-GHz backhaul radio. CAC is supported on the backhaul and the CCXv4 clients (which provides CAC between the mesh access point and the client).

**Note**

Voice is supported only on indoor mesh networks. Voice is supported on a best-effort basis in the outdoors in a mesh network.

## Call Admission Control

Call Admission Control (CAC) enables a mesh access point to maintain controlled quality of service (QoS) when the wireless LAN is experiencing congestion. The Wi-Fi Multimedia (WMM) protocol deployed in CCXv3 ensures sufficient QoS as long as the wireless LAN is not congested. However, to maintain QoS under differing network loads, CAC in CCXv4 or later is required.

**Note**

CAC is supported in Cisco Compatible Extensions (CCX) v4 or later. See Chapter 6 of the *Cisco Wireless LAN Controller Configuration Guide* at <http://www.cisco.com/en/US/docs/wireless/controller/7.0/configuration/guide/c70sol.html>

Two types of CAC are available for access points: bandwidth-based CAC and load-based CAC. All calls on a mesh network are bandwidth-based, so mesh access points use only bandwidth-based CAC.

Bandwidth-based, or static CAC enables the client to specify how much bandwidth or shared medium time is required to accept a new call. Each access point determines whether it is capable of accommodating a particular call by looking at the bandwidth available and compares it against the bandwidth required for the call. If there is not enough bandwidth available to maintain the maximum allowed number of calls with acceptable quality, the mesh access point rejects the call.

## Quality of Service and Differentiated Services Code Point Marking

Cisco supports 802.11e on the local access and on the backhaul. Mesh access points prioritize user traffic based on classification, and therefore all user traffic is treated on a best-effort basis.

Resources available to users of the mesh vary, according to the location within the mesh, and a configuration that provides a bandwidth limitation in one point of the network can result in an oversubscription in other parts of the network.

Similarly, limiting clients on their percentage of RF is not suitable for mesh clients. The limiting resource is not the client WLAN, but the resources available on the mesh backhaul.

Similar to wired Ethernet networks, 802.11 WLANs employ Carrier Sense Multiple Access (CSMA), but instead of using collision detection (CD), WLANs use collision avoidance (CA), which means that instead of each station trying to transmit as soon as the medium is free, WLAN devices will use a collision avoidance mechanism to prevent multiple stations from transmitting at the same time.

The collision avoidance mechanism uses two values called CWmin and CWmax. CW stands for contention window. The CW determines what additional amount of time an endpoint should wait, after the interframe space (IFS), to attend to transmit a packet. Enhanced distributed coordination function (EDCF) is a model that allows end devices that have delay-sensitive multimedia traffic to modify their CWmin and CWmax values to allow for statically greater (and more frequent) access to the medium.

Cisco access points support EDCF-like QoS. This provides up to eight queues for QoS.

These queues can be allocated in several different ways, as follows:

- Based on TOS / DiffServ settings of packets
- Based on Layer 2 or Layer 3 access lists
- Based on VLAN
- Based on dynamic registration of devices (IP phones)

AP1500s, with Cisco controllers, provide a minimal integrated services capability at the controller, in which client streams have maximum bandwidth limits, and a more robust differentiated services (diffServ) capability based on the IP DSCP values and QoS WLAN overrides.

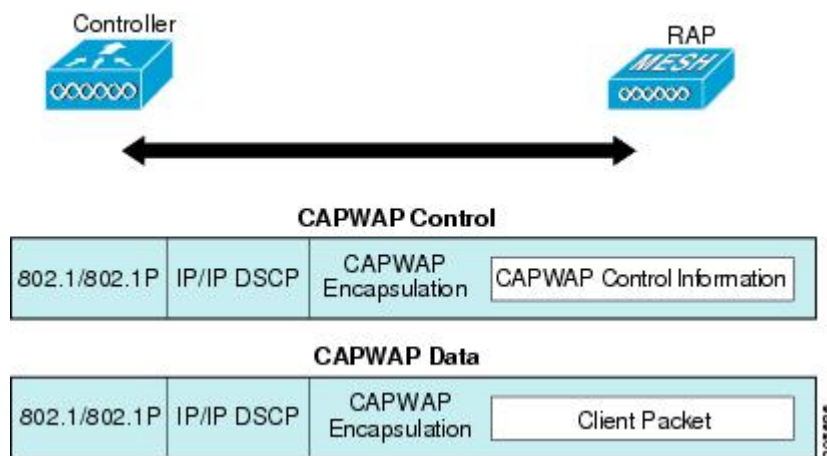
When the queue capacity has been reached, additional frames are dropped (tail drop).

### Encapsulations

Several encapsulations are used by the mesh system. These encapsulations include CAPWAP control and data between the controller and RAP, over the mesh backhaul, and between the mesh access point and its client(s). The encapsulation of bridging traffic (noncontroller traffic from a LAN) over the backhaul is the same as the encapsulation of CAPWAP data.

There are two encapsulations between the controller and the RAP. The first is for CAPWAP control, and the second is for CAPWAP data. In the control instance, CAPWAP is used as a container for control information and directives. In the instance of CAPWAP data, the entire packet, including the Ethernet and IP headers, is sent in the CAPWAP container.

**Figure 75: Encapsulations**

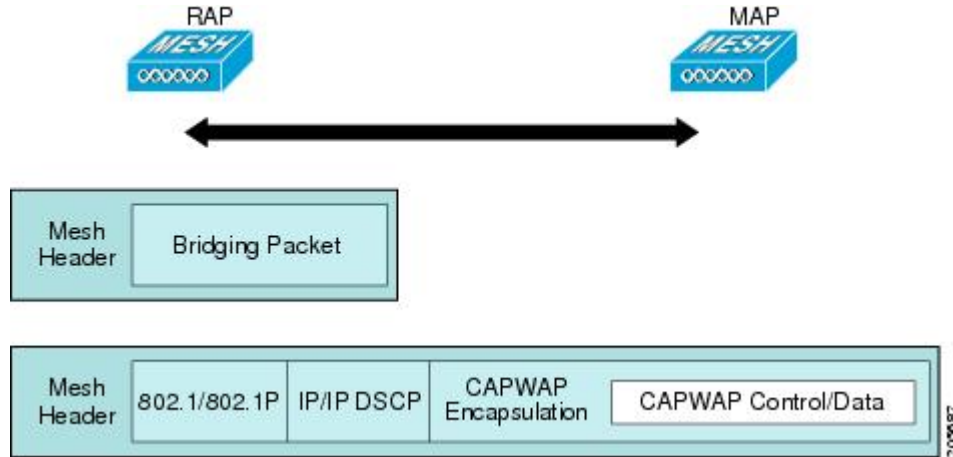


For the backhaul, there is only one type of encapsulation, encapsulating mesh traffic. However, two types of traffic are encapsulated: bridging traffic and CAPWAP control and data traffic. Both types of traffic are encapsulated in a proprietary mesh header.

In the case of bridging traffic, the entire packet Ethernet frame is encapsulated in the mesh header.

All backhaul frames are treated identically, regardless of whether they are MAP to MAP, RAP to MAP, or MAP to RAP.

**Figure 76: Encapsulating Mesh Traffic**



**Queuing on the Mesh Access Point**

The mesh access point uses a high speed CPU to process ingress frames, Ethernet, and wireless on a first-come, first-serve basis. These frames are queued for transmission to the appropriate output device, either Ethernet or wireless. Egress frames can be destined for either the 802.11 client network, the 802.11 backhaul network, or Ethernet.

AP1500s support four FIFOs for wireless client transmissions. These FIFOs correspond to the 802.11e platinum, gold, silver, and bronze queues, and obey the 802.11e transmission rules for those queues. The FIFOs have a user configurable queue depth.

The backhaul (frames destined for another outdoor mesh access point) uses four FIFOs, although user traffic is limited to gold, silver, and bronze. The platinum queue is used exclusively for CAPWAP control traffic and voice, and has been reworked from the standard 802.11e parameters for CWmin, CWmax, and so on, to provide more robust transmission but higher latencies.

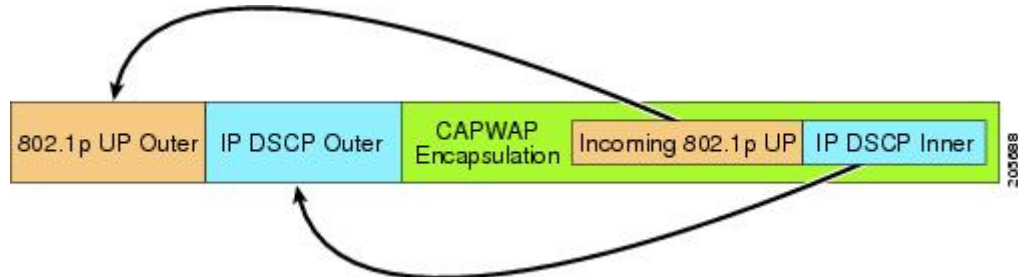
The 802.11e parameters for CWmin, CWmax, and so on, for the gold queue have been reworked to provide lower latency at the expense of slightly higher error rate and aggressiveness. The purpose of these changes is to provide a channel that is more conducive to video applications.

Frames that are destined for Ethernet are queued as FIFO, up to the maximum available transmit buffer pool (256 frames). There is support for a Layer 3 IP Differentiated Services Code Point (DSCP), so marking of the packets is there as well.

In the controller to RAP path for the data traffic, the outer DSCP value is set to the DSCP value of the incoming IP frame. If the interface is in tagged mode, the controller sets the 802.1Q VLAN ID and derives the 802.1p

UP (outer) from 802.1p UP incoming and the WLAN default priority ceiling. Frames with VLAN ID 0 are not tagged.

**Figure 77: Controller to RAP Path**



For CAPWAP control traffic the IP DSCP value is set to 46, and the 802.1p user priority is set to 7. Prior to transmission of a wireless frame over the backhaul, regardless of node pairing (RAP/MAP) or direction, the DSCP value in the outer header is used to determine a backhaul priority. The following sections describe the mapping between the four backhaul queues the mesh access point uses and the DSCP values shown in Backhaul Path QoS.

**Table 35: Backhaul Path QoS**

DSCP Value	Backhaul Queue
2, 4, 6, 8 to 23	Bronze
26, 32 to 63	Gold
46 to 56	Platinum
All others including 0	Silver



**Note**

The platinum backhaul queue is reserved for CAPWAP control traffic, IP control traffic, and voice packets. DHCP, DNS, and ARP requests are also transmitted at the platinum QoS level. The mesh software inspects each frame to determine whether it is a CAPWAP control or IP control frame in order to protect the platinum queue from use by non-CAPWAP applications.

For a MAP to the client path, there are two different procedures, depending on whether the client is a WMM client or a normal client. If the client is a WMM client, the DSCP value in the outer frame is examined, and the 802.11e priority queue is used.

**Table 36: MAP to Client Path QoS**

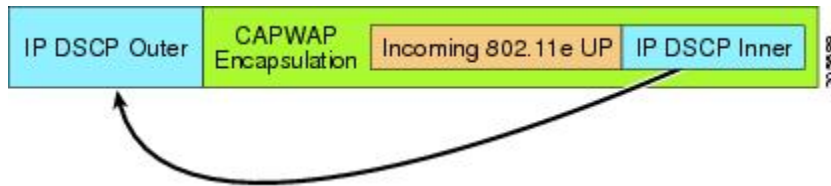
DSCP Value	Backhaul Queue
2, 4, 6, 8 to 23	Bronze

DSCP Value	Backhaul Queue
26, 32 to 45, 47	Gold
46, 48 to 63	Platinum
All others including 0	Silver

If the client is not a WMM client, the WLAN override (as configured at the controller) determines the 802.11e queue (bronze, gold, platinum, or silver), on which the packet is transmitted.

For a client of a mesh access point, there are modifications made to incoming client frames in preparation for transmission on the mesh backhaul or Ethernet. For WMM clients, a MAP illustrates the way in which the outer DSCP value is set from an incoming WMM client frame.

**Figure 78: MAP to RAP Path**



The minimum value of the incoming 802.11e user priority and the WLAN override priority is translated using the information listed in [Table 37: DSCP to Backhaul Queue Mapping, on page 179](#) to determine the DSCP value of the IP frame. For example, if the incoming frame has as its value a priority indicating the gold priority, but the WLAN is configured for the silver priority, the minimum priority of silver is used to determine the DSCP value.

**Table 37: DSCP to Backhaul Queue Mapping**

DSCP Value	802.11e UP	Backhaul Queue	Packet Types
2, 4, 6, 8 to 23	1, 2	Bronze	Lowest priority packets, if any
26, 32 to 34	4, 5	Gold	Video packets
46 to 56	6, 7	Platinum	CAPWAP control, AWPP, DHCP/DNS, ARP packets, voice packets
All others including 0	0, 3	Silver	Best effort, CAPWAP data packets

If there is no incoming WMM priority, the default WLAN priority is used to generate the DSCP value in the outer header. If the frame is an originated CAPWAP control frame, the DSCP value of 46 is placed in the outer header.

With the 5.2 code enhancements, DSCP information is preserved in an AWPP header.

All wired client traffic is restricted to a maximum 802.1p UP value of 5, except DHCP/DNS and ARP packets, which go through the platinum queue.

The non-WMM wireless client traffic gets the default QoS priority of its WLAN. The WMM wireless client traffic may have a maximum 802.11e value of 6, but it must be below the QoS profile configured for its WLAN. If admission control is configured, WMM clients must use TSPEC signaling and get admitted by CAC.

The CAPWAPP data traffic carries wireless client traffic and has the same priority and treatment as wireless client traffic.

Now that the DSCP value is determined, the rules described earlier for the backhaul path from the RAP to the MAP are used to further determine the backhaul queue on which the frame is transmitted. Frames transmitted from the RAP to the controller are not tagged. The outer DSCP values are left intact, as they were first constructed.

### Bridging Backhaul Packets

Bridging services are treated a little differently from regular controller-based services. There is no outer DSCP value in bridging packets because they are not CAPWAP encapsulated. Therefore, the DSCP value in the IP header as it was received by the mesh access point is used to index into the table as described in the path from the mesh access point to the mesh access point (backhaul).

### Bridging Packets from and to a LAN

Packets received from a station on a LAN are not modified in any way. There is no override value for the LAN priority. Therefore, the LAN must be properly secured in bridging mode. The only protection offered to the mesh backhaul is that non-CAPWAP control frames that map to the platinum queue are demoted to the gold queue.

Packets are transmitted to the LAN precisely as they are received on the Ethernet ingress at entry to the mesh.

The only way to integrate QoS between Ethernet ports on AP1500 and 802.11a is by tagging Ethernet packets with DSCP. AP1500s take the Ethernet packet with DSCP and places it in the appropriate 802.11e queue.

AP1500s do not tag DSCP itself:

- On the ingress port, the AP1500 sees a DSCP tag, encapsulates the Ethernet frame, and applies the corresponding 802.11e priority.
- On the egress port, the AP1500 decapsulates the Ethernet frame, and places it on the wire with an untouched DSCP field.

Ethernet devices, such as video cameras, should have the capability to mark the bits with DSCP value to take advantage of QoS.



#### Note

QoS only is relevant when there is congestion on the network.

## Guidelines For Using Voice on the Mesh Network

Follow these guidelines when you use voice on the mesh network:

- Voice is supported only on indoor mesh networks. For outdoors, voice is supported on a best-effort basis on a mesh infrastructure.



- When voice is operating on a mesh network, calls must not traverse more than two hops. Each sector must be configured to require no more than two hops for voice.
- RF considerations for voice networks are as follows:
  - Coverage hole of 2 to 10 percent
  - Cell coverage overlap of 15 to 20 percent
  - Voice needs RSSI and SNR values that are at least 15 dB higher than data requirements
  - RSSI of -67 dBm for all data rates should be the goal for 11b/g/n and 11a/n
  - SNR should be 25 dB for the data rate used by client to connect to the AP
  - Packet error rate (PER) should be configured for a value of one percent or less
  - Channel with the lowest utilization (CU) must be used
- On the **802.11a/n** or **802.11b/g/n** > *Global* parameters page, do the following:
  - Enable dynamic target power control (DTPC).
  - Disable all data rates less than 11 Mbps.
- On the **802.11a/n** or **802.11b/g/n** > *Voice* parameters page, do the following:
  - Load-based CAC must be disabled.
  - Enable admission control (ACM) for CCXv4 or v5 clients that have WMM enabled. Otherwise, bandwidth-based CAC does not operate properly.
  - Set the maximum RF bandwidth to 50 percent.
  - Set the reserved roaming bandwidth to 6 percent.
  - Enable traffic stream metrics.
- On the **802.11a/n** or **802.11b/g/n** > *EDCA* parameters page, you should do the following:
  - Set the EDCA profile for the interface as voice optimized.
  - Disable low latency MAC.
- On the **QoS** > *Profile* page, you should do the following:
  - Create a voice profile and select 802.1Q as the wired QoS protocol type.
- On the **WLANs** > *Edit* > *QoS* page, you should do the following:
  - Select a QoS of platinum for voice and gold for video on the backhaul.
  - Select allowed as the WMM policy.
- On the **WLANs** > *Edit* > *QoS* page, you should do the following:
  - Select CCKM for authorization (*auth*) key management (*mgmt*) if you want to support fast roaming.
- On the **x > y** page, you should do the following:

- Disable voice active detection (VAD).

## Voice Call Support in a Mesh Network

Table 38: Calls Possible with 1520 Series in 802.11a and 802.11b/g Radios, on page 182 shows the actual calls in a clean, ideal environment.

**Table 38: Calls Possible with 1520 Series in 802.11a and 802.11b/g Radios**

No. of Calls <sup>24</sup>	802.11a Radio	802.11b/g Radio
RAP	12	12
MAP1	7	10
MAP2	4	8

- <sup>24</sup> Traffic was bidirectional 64K voice flows. VoCoder type: G.711, PER <= 1%. Network setup was daisy-chained with no calls traversing more than 2 hops. No external interference.

Table 39: Calls Possible with 1550 Series in 802.11a/n 802.11b/g/n Radios, on page 182 shows the actual calls in a clean, ideal environment.

**Table 39: Calls Possible with 1550 Series in 802.11a/n 802.11b/g/n Radios**

No. of Calls <sup>25</sup>	802.11a/n Radio 20 MHz	802.11a/n Radio 40 MHz	802.11b/g/n Backhaul Radio 20 MHz	802.11b/g/n Backhaul Radio 40 MHz
RAP	20	35	20	20
MAP1 (First Hop)	10	20	15	20
MAP2 (Second Hop)	8	15	10	15

- <sup>25</sup> Traffic was bidirectional 64K voice flows. VoCoder type: G.711, PER <= 1%. Network setup was daisy-chained with no calls traversing more than 2 hops. No external interference.

While making a call, observe the MOS score of the call on the 7921 phone. A MOS score between 3.5 and 4 is acceptable.

**Table 40: MOS Ratings**

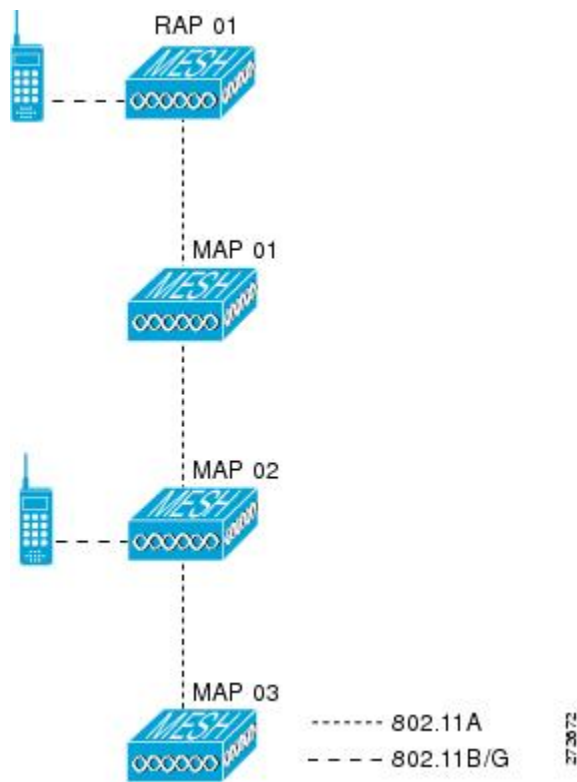
MOS rating	User satisfaction
> 4.3	Very satisfied
4.0	Satisfied

MOS rating	User satisfaction
3.6	Some users dissatisfied
3.1	Many users dissatisfied
< 2.58	—

### Viewing the Voice Details for Mesh Networks (CLI)

Use the commands in this section to view details on voice and video calls on the mesh network:

**Figure 79: Mesh Network Example**



- To view the total number of voice calls and the bandwidth used for voice calls on each RAP, enter this command:

**show mesh cac summary**

Information similar to the following appears:

AP Name	Slot#	Radio	BW Used/Max	Calls
SB_RAP1	0	11b/g	0/23437	0
	1	11a	0/23437	2

```

SB_MAP1          0  11b/g    0/23437    0
                  1  11a      0/23437    0
SB_MAP2          0  11b/g    0/23437    0
                  1  11a      0/23437    0
SB_MAP3          0  11b/g    0/23437    0
                  1  11a      0/23437    0?

```

- To view the mesh tree topology for the network and the bandwidth utilization (used/maximum available) of voice calls and video links for each mesh access point and radio, enter this command:

**show mesh cac bwused {voice | video} AP\_name**

Information similar to the following appears:

```

AP Name          Slot#    Radio      BW Used/Max
-----
SB_RAP1          0        11b/g      1016/23437
                  1        11a      3048/23437
|SB_MAP1         0        11b/g      0/23437
                  1        11a      3048/23437
|| SB_MAP2       0        11b/g      2032/23437
                  1        11a      3048/23437
||| SB_MAP3      0        11b/g      0/23437
                  1        11a      0/23437

```



**Note** The bars (|) to the left of the AP Name field indicate the number of hops that the MAP is from its RAP.



**Note** When the radio type is the same, the backhaul bandwidth utilization (bw used/max) at each hop is identical. For example, mesh access points *map1*, *map2*, *map3*, and *rap1* are all on the same radio backhaul (802.11a) and are using the same bandwidth (3048). All of the calls are in the same interference domain. A call placed anywhere in that domain affects the others.

- To view the mesh tree topology for the network and display the number of voice calls that are in progress by mesh access point radio, enter this command:

**show mesh cac access AP\_name**

Information similar to the following appears:

```

AP Name          Slot#    Radio      Calls
-----
SB_RAP1          0        11b/g      0
                  1        11a      0
| SB_MAP1        0        11b/g      0
                  1        11a      0
|| SB_MAP2       0        11b/g      1
                  1        11a      0
||| SB_MAP3      0        11b/g      0
                  1        11a      0

```



**Note** Each call received by a mesh access point radio causes the appropriate calls summary column to increment by one. For example, if a call is received on the 802.11b/g radio on map2, then a value of one is added to the existing value in that radio's *calls* column. In this case, the new call is the only active call on the 802.11b/g radio of map2. If one call is active when a new call is received, the resulting value is two.

- To view the mesh tree topology for the network and display the voice calls that are in progress, enter this command:

**show mesh cac callpath** *AP\_name*

Information similar to the following appears:

AP Name	Slot#	Radio	Calls
SB_RAP1	0	11b/g	0
	1	11a	1
SB_MAP1	0	11b/g	0
	1	11a	1
SB_MAP2	0	11b/g	1
	1	11a	1
SB_MAP3	0	11b/g	0
	1	11a	0



**Note** The *calls* column for each mesh access point radio in a call path increments by one. For example, for a call that initiates at map2 (**show mesh cac call path** *SB\_MAP2*) and terminates at rap1 by way of map1, one call is added to the map2 802.11b/g and 802.11a radio *calls* column, one call to the map1 802.11a backhaul radio *calls* column, and one call to the rap1 802.11a backhaul radio *calls* column.

- To view the mesh tree topology of the network, the voice calls that are rejected at the mesh access point radio due to insufficient bandwidth, and the corresponding mesh access point radio where the rejection occurred, enter this command:

**show mesh cac rejected** *AP\_name*

Information similar to the following appears:

AP Name	Slot#	Radio	Calls
SB_RAP1	0	11b/g	0
	1	11a	0
SB_MAP1	0	11b/g	0
	1	11a	0
SB_MAP2	0	11b/g	1
	1	11a	0
SB_MAP3	0	11b/g	0
	1	11a	0



**Note** If a call is rejected at the map2 802.11b/g radio, its *calls* column increments by one.

- To view the number of bronze, silver, gold, platinum, and management queues active on the specified access point, enter this command. The peak and average length of each queue are shown as well as the overflow count.

**show mesh queue-stats** *AP\_name*

Information similar to the following appears:

Queue Type	Overflows	Peak length	Average length
Silver	0	1	0.000
Gold	0	4	0.004
Platinum	0	4	0.001
Bronze	0	0	0.000
Management	0	0	0.000

**Overflows**—The total number of packets dropped due to queue overflow.

**Peak Length**—The peak number of packets waiting in the queue during the defined statistics time interval.

**Average Length**—The average number of packets waiting in the queue during the defined statistics time interval.

## Enabling Mesh Multicast Containment for Video

You can use the controller CLI to configure three mesh multicast modes to manage video camera broadcasts on all mesh access points. When enabled, these modes reduce unnecessary multicast transmissions within the mesh network and conserve backhaul bandwidth.

Mesh multicast modes determine how bridging-enabled access points MAP and RAP send multicasts among Ethernet LANs within a mesh network. Mesh multicast modes manage non-CAPWAP multicast traffic only. CAPWAP multicast traffic is governed by a different mechanism.

The three mesh multicast modes are as follows:

- **Regular mode**—Data is multicast across the entire mesh network and all its segments by bridging-enabled RAP and MAP.
- **In-only mode**—Multicast packets received from the Ethernet by a MAP are forwarded to the RAP's Ethernet network. No additional forwarding occurs, which ensures that non-CAPWAP multicasts received by the RAP are not sent back to the MAP Ethernet networks within the mesh network (their point of origin), and MAP to MAP multicasts do not occur because they are filtered out.



### Note

When an HSRP configuration is in operation on a mesh network, we recommend the In-Out multicast mode be configured.

- **In-out mode**—The RAP and MAP both multicast but in a different manner:
  - In-out mode is the default mode.
  - If multicast packets are received at a MAP over Ethernet, they are sent to the RAP; however, they are not sent to other MAP over Ethernet, and the MAP to MAP packets are filtered out of the multicast.
  - If multicast packets are received at a RAP over Ethernet, they are sent to all the MAPs and their respective Ethernet networks. When the in-out mode is in operation, it is important to properly

partition your network to ensure that a multicast sent by one RAP is not received by another RAP on the same Ethernet segment and then sent back into the network.



**Note** If 802.11b clients need to receive CAPWAP multicasts, then multicast must be enabled globally on the controller as well as on the mesh network (using the **config network multicast global enable** CLI command). If multicast does not need to extend to 802.11b clients beyond the mesh network, the global multicast parameter should be disabled (using the **config network multicast global disable** CLI command).

## Enabling Multicast on the Mesh Network (CLI)

To enable multicast mode on the mesh network to receive multicasts from beyond the mesh networks, enter these commands:

```
config network multicast global enable
config mesh multicast {regular | in | in-out}
```

To enable multicast mode only the mesh network (multicasts do not need to extend to 802.11b clients beyond the mesh network), enter these commands:

```
config network multicast global disable
config mesh multicast {regular | in | in-out}
```



**Note** Multicast for mesh networks cannot be enabled using the controller GUI.

## IGMP Snooping

IGMP snooping delivers improved RF usage through selective multicast forwarding and optimizes packet forwarding in voice and video applications.

A mesh access point transmits multicast packets only if a client is associated with the mesh access point that is subscribed to the multicast group. So, when IGMP snooping is enabled, only that multicast traffic relevant to given hosts is forwarded.

To enable IGMP snooping on the controller, enter the following command:

```
configure network multicast igmp snooping enable
```

A client sends an IGMP *join* that travels through the mesh access point to the controller. The controller intercepts the *join* and creates a table entry for the client in the multicast group. The controller then proxies the IGMP *join* through the upstream switch or router.

You can query the status of the IGMP groups on a router by entering the following command:

```
router# show ip gmp groups
IGMP Connected Group Membership

Group Address      Interface  Uptime   Expires   Last Reporter
```

```
233.0.0.1      Vlan119      3w1d      00:01:52      10.1.1.130
```

For Layer 3 roaming, an IGMP query is sent to the client's WLAN. The controller modifies the client's response before forwarding and changes the source IP address to the controller's dynamic interface IP address.

The network hears the controller's request for the multicast group and forwards the multicast to the new controller.

For more information about video, see the following:

- *Video Surveillance over Mesh Deployment Guide*: [http://www.cisco.com/en/US/tech/tk722/tk809/technologies\\_tech\\_note09186a0080b02511.shtml](http://www.cisco.com/en/US/tech/tk722/tk809/technologies_tech_note09186a0080b02511.shtml)
- *Cisco Unified Wireless Network Solution: VideoStream Deployment Guide*: [http://www.cisco.com/en/US/products/ps10315/products\\_tech\\_note09186a0080b6e11e.shtml](http://www.cisco.com/en/US/products/ps10315/products_tech_note09186a0080b6e11e.shtml)

## Locally Significant Certificates for Mesh APs

Until the 7.0 release, mesh APs supported only the Manufactured Installed Certificate (MIC) to authenticate and get authenticated by controllers to join the controller. You might have had to have your own public key infrastructure (PKI) to control CAs, to define policies, to define validity periods, to define restrictions and usages on the certificates that are generated, and get these certificates installed on the APs and controllers. After these customer-generated or locally significant certificates (LSCs) are present on the APs and controllers, the devices start using these LSCs, to join, authenticate, and derive a session key. Cisco supported normal APs from the 5.2 release and later releases and extended the support for mesh APs as well from the 7.0 release.

- Graceful fallback to MIC if APs are unable to join the controller with LSC certificates—Local APs try to join a controller with an LSC for the number of times that are configured on the controller (the default value is 3). After these trials, the AP deletes the LSC and tries to join a controller with an MIC.

Mesh APs try to join a controller with an LSC until its lonely timer expires and the AP reboots. The lonely timer is set for 40 minutes. After the reboot, the AP tries to join a controller with an MIC. If the AP is again not able to join a controller with an MIC in 40 minutes, the AP reboots and then tries to join a controller with an LSC.




---

**Note** An LSC in mesh APs is not deleted. An LSC is deleted in mesh APs only when the LSC is disabled on the controller, which causes the APs to reboot.

---

- Over the air provisioning of MAPs.

## Guidelines for Configuration

Follow these guidelines when using LSCs for mesh APs:

- This feature does not remove any preexisting certificates from an AP. It is possible for an AP to have both LSC and MIC certificates.
- After an AP is provisioned with an LSC, it does not read in its MIC certificate on boot-up. A change from an LSC to an MIC will require the AP to reboot. APs do it for a fallback if they cannot be joined with an LSC.



- Provisioning an LSC on an AP does not require an AP to turn off its radios, which is vital for mesh APs, which may get provisioned over-the-air.
- Because mesh APs need a dot1x authentication, a CA and ID certificate is required to be installed on the server in the controller.
- LSC provisioning can happen over Ethernet and over-the-air in case of MAPs. You have to connect the mesh AP to the controller through Ethernet and get the LSC certificate provisioned. After the LSC becomes the default, an AP can be connected over-the-air to the controller using the LSC certificate.

## Differences Between LSCs for Mesh APs and Normal APs

CAPWAP APs use LSC for DTLS setup during a JOIN irrespective of the AP mode. Mesh APs also use the certificate for mesh security, which involves a dot1x authentication with the controller through the parent AP. After the mesh APs are provisioned with an LSC, they need to use the LSC for this purpose because MIC will not be read in.

Mesh APs use a statically configured dot1x profile to authenticate.

This profile is hardcoded to use "cisco" as the certificate issuer. This profile needs to be made configurable so that vendor certificates can be used for mesh authentication (enter the **config local-auth eap-profile cert-issuer vendor "prfMaP1500LIEAuth93"** command).

You must enter the **config mesh lsc enable/disable** command to enable or disable an LSC for mesh APs. This command will cause all the mesh APs to reboot.



### Note

---

An LSC on mesh is open for very specific Oil and Gas customers with the 7.0 release. Initially, it is a hidden feature. The **config mesh lsc enable/disable** is a hidden command. Also, the **config local-auth eap-profile cert-issuer vendor "prfMaP1500LIEAuth93"** command is a normal command, but the "prfMaP1500LIEAuth93" profile is a hidden profile, and is not stored on the controller and is lost after the controller reboot.

---

## Certificate Verification Process in LSC AP

LSC-provisioned APs have both LSC and MIC certificates, but the LSC certificate will be the default one. The verification process consists of the following two steps:

- 1 The controller sends the AP the MIC device certificate, which the AP verifies with the MIC CA.
- 2 The AP sends the LSC device certificate to the controller, which the controller verifies with the LSC CA.

## Getting Certificates for LSC Feature

To configure LSC, you must first gather and install the appropriate certificates on the controller. The following steps show how to accomplish this using Microsoft 2003 Server as the CA server.

To get the certificates for LSC, follow these steps:

- 
- Step 1** Go to the CA server (<http://<ip address of caserver/crtsrv>>) and login.
- Step 2** Get the CA certificate as follows:
- Click the Download a CA certificate link, certificate chain, or CRF.
  - Choose the encoding method as DER.
  - Click the Download CA certificate link and use the save option to download the CA certificate on to your local machine.
- Step 3** To use the certificate on the controller, convert the downloaded certificate to PEM format. You can convert this in a Linux machine using the following command:
- ```
# openssl x509 -in <input.cer> -inform DER -out <output.cer> -outform PEM
```
- Step 4** Configure the CA certificate on the controller as follows:
- Choose **COMMANDS > Download File**.
  - Choose the file type as Vendor CA Certificate from the File Type drop-down list.
  - Update the rest of the fields with the information of the TFTP server where the certificate is located.
  - Click **Download**.
- Step 5** To install the Device certificate on the WLC, login to the CA server as mentioned in Step 1 and do the following:
- Click the Request a certificate link.
  - Click the advanced certificate request link.
  - Click Create and submit a request to this CA link.
  - Go to the next screen and choose the Server Authentication Certificate from the Certificate Template drop-down list.
  - Enter a valid name, email, company, department, city, state, and country/region. (Remember it in case you want the cap method to check the username against its database of user credentials).
 

**Note** The e-mail is not used.
  - Enable Mark keys as exportable.
  - Click **Submit**.
  - Install the certificate on your laptop.
- Step 6** Convert the device certificate obtained in the Step 5. To get the certificate, go to your internet browser options and choose exporting to a file. Follow the options from your browser to do this. You need to remember the password that you set here.
- To convert the certificate, use the following command in a Linux machine:
- ```
# openssl pkcs12 -in <input.pfx> -out <output.cer>
```
- Step 7** On the controller GUI, choose **Command > Download File**. Choose Vendor Device Certificate from the File Type drop-down list. Update the rest of the fields with the information of the TFTP server where the certificate is located and the password you set in the previous step and click **Download**.
- Step 8** Reboot the controller so that the certificates can then be used.
- Step 9** You can check that the certificates were successfully installed on the controller using this command:  
**show local-auth certificates**
-

## Configuring a Locally Significant Certificate (CLI)

To configure a locally significant certificate (LSC), follow these steps:

- 
- Step 1** Enable LSC and provision the LSC CA certificate in the controller.
- Step 2** Enter the following command:  
**config local-auth eap-profile cert-issuer vendor** *prfMaP1500LIEAuth93*
- Step 3** Turn on the feature by entering the following command:  
**config mesh lsc {enable | disable}**

- Step 4** Connect the mesh AP through Ethernet and provision for an LSC certificate.
- Step 5** Let the mesh AP get a certificate and join the controller using the LSC certificate.

**Figure 80: Local Significant Certificate Page**

Security Local Significant Certificates (LSC) Ap

General AP Provisioning

Certificate Type	Status
CA	Not Present

General

Enable LSC on Controller

CA Server

CA server URL   
(Ex: http://10.0.0.1:8080/caaserver)

Params

Country Code	<input type="text" value="US"/>
State	<input type="text" value="San Jose"/>
City	<input type="text" value="San Jose"/>
Organization	<input type="text" value="Cisco"/>
Department	<input type="text" value="Sales"/>
E-mail	<input type="text" value="sales@cisco.com"/>
Key Size	<input type="text" value="1024"/>

279072

**Figure 81: AP Policy Configuration**

AP Policies Apply Add

Policy Configuration

Authorize APs against AAA	<input type="checkbox"/> Enabled
Accept Self Signed Certificate (SSC)	<input type="checkbox"/> Enabled
Accept Manufactured Installed Certificate (MIC)	<input type="checkbox"/> Enabled
Accept Locally Significant Certificate (LSC)	<input type="checkbox"/> Enabled

Entries 1 - 1 of 1

AP Authorization List

Search by MAC  Search

MAC Address	Certificate Type	SHA1 Key Hash
00:16:36:91:9a:27	MIC	

279073

## LSC-Related Commands

The following commands are related to LSCs:

- **config certificate lsc {enable | disable}**

- **enable**—To enable an LSC on the system.
- **disable**—To disable an LSC on the system. Use this keyword to remove the LSC device certificate and send a message to an AP, to do the same and disable an LSC, so that subsequent joins could be made using the MIC/SSC. The removal of the LSC CA cert on the WLC should be done explicitly by using the CLI to accommodate any AP that has not transitioned back to the MIC/SSC.

- **config certificate lsc ca-server url-path *ip-address***

Following is the example of the URL when using Microsoft 2003 server:

```
http:<ip address of CA>/sertsrv/mscep/mscep.dll
```

This command configures the URL to the CA server for getting the certificates. The URL contains either the domain name or the IP address, port number (typically=80), and the CGI-PATH.

```
http://ipaddr:port/cgi-path
```

Only one CA server is allowed to be configured. The CA server has to be configured to provision an LSC.

- **config certificate lsc ca-server delete**

This command deletes the CA server configured on the controller.

- **config certificate lsc ca-cert {add | delete}**

This command adds or deletes the LSC CA certificate into/from the controller's CA certificate database as follows:

- **add**—Queries the configured CA server for a CA certificate using the SCEP getca operation, and gets into the WLC and installs it permanently into the WLC database. If installed, this CA certificate is used to validate the incoming LSC device certificate from the AP.
- **delete**—Deletes the LSC CA certificate from the WLC database.

- **config certificate lsc subject-params *Country State City Orgn Dept Email***

This command configures the parameters for the device certificate that will be created and installed on the controller and the AP.

All of these strings have 64 bytes, except for the Country that has a maximum of 3 bytes. The Common Name is automatically generated using its Ethernet MAC address. This should be given prior to the creation of the controller device certificate request.

The above parameters are sent as an LWAPP payload to the AP, so that the AP can use these parameters to generate the certReq. The CN is automatically generated on the AP using the current MIC/SSC "Cxxxx-MacAddr" format, where xxxx is the product number.

- **config certificate lsc other-params *keysize***

The default keysize value is 2048 bits.

- **config certificate lsc ap-provision {enable | disable}**

This command enables or disables the provisioning of the LSCs on the APs if the APs just joined using the SSC/MIC. If enabled, all APs that join and do not have the LSC will get provisioned.

If disabled, no more automatic provisioning will be done. This command does not affect the APs, which already have LSCs in them.

- **config certificate lsc ra-cert {add | delete}**

We recommend this command when the CA server is a Cisco IOS CA server. The controller can use the RA to encrypt the certificate requests and make communication more secure. RA certificates are not currently supported by other external CA servers, such as MSFT.

- **add**—Queries the configured CA server for an RA certificate using the SCEP operation and installs it into the controller database. This keyword is used to get the certReq signed by the CA.
- **delete**—Deletes the LSC RA certificate from the WLC database.

- **config auth-list ap-policy lsc {enable | disable}**

After getting the LSC, an AP tries to join the controller. Before the AP tries to join the controller, you must mandatorily enter this command on the controller console. By default, the **config auth-list ap-policy lsc** command is in the disabled state, and the APs are not allowed to join the controller using the LSC.

- **config auth-list ap-policy mic {enable | disable}**

After getting the MIC, an AP tries to join the controller. Before the AP tries to join the controller, you must mandatorily enter this command on the controller console. By default, the **config auth-list ap-policy mic** command is in the enabled state. If an AP cannot join because of the enabled state, this log message on the controller side is displayed: LSC/MIC AP is not allowed to join.

- **show certificate lsc summary**

This command displays the LSC certificates installed on the WLC. It would be the CA certificate, device certificate, and optionally, an RA certificate if the RA certificate has also been installed. It also indicates if an LSC is enabled or not.

- **show certificate lsc ap-provision**

This command displays the status of the provisioning of the AP, whether it is enabled or disabled, and whether a provision list is present or not.

- **show certificate lsc ap-provision details**

This command displays the list of MAC addresses present in the AP provisioning lists.

## Controller GUI Security Settings

Although the settings are not directly related to the feature, it might help you in achieving the desired behavior with respect to APs provisioned with an LSC.

- Case 1—Local MAC Authorization and Local EAP Authentication

Add the MAC address of RAP/MAP to the controller MAC filter list.

Example:

```
(Cisco Controller) > config macfilter mac-delimiter colon
(Cisco Controller) > config macfilter add 00:0b:85:60:92:30 0 management
```

- Case 2—External MAC Authorization and Local EAP authentication

Enter the following command on the WLC:

```
(Cisco Controller) > config mesh security rad-mac-filter enable
```

or

Check only the external MAC filter authorization on the GUI page and follow these guidelines:

- Do not add the MAC address of the RAP/MAP to the controller MAC filter list.
- Configure the external radius server details on the WLC.
- Enter the **config macfilter mac-delimiter colon** command configuration on the WLC.
- Add the MAC address of the RAP/MAP in the external radius server in the following format:  
User name: 11:22:33:44:55:66 Password : 11:22:33:44:55:66

## Deployment Guidelines

- When using local authorization, the controller should be installed with the vendor's CA and device certificate.
- When using an external AAA server, the controller should be installed with the vendor's CA and device certificate.
- Mesh security should be configured to use 'vendor' as the cert-issuer.
- MAPs cannot move from an LSC to an MIC when they fall back to a backup controller.

The **config mesh lsc {enable | disable}** command is required to enable or disable an LSC for mesh APs. This command causes all the mesh APs to reboot.







## Checking the Health of the Network

This chapter describes how to check the health of a mesh network and contains the following sections:

- [Show Mesh Commands, page 197](#)
- [Viewing Mesh Statistics for a Mesh Access Point, page 202](#)
- [Viewing Neighbor Statistics for a Mesh Access Point, page 207](#)

### Show Mesh Commands

The **show mesh** commands are grouped under the following sections:

- [Viewing General Mesh Network Details](#)
- [Viewing Mesh Access Point Details](#)
- [Viewing Public Safety Setting](#)
- [Viewing Security Settings and Statistics](#)

### Viewing General Mesh Network Details

To view general mesh network details, enter these commands:

- **show mesh env {summary | AP\_name}**—Shows the temperature, heater status, and Ethernet status for either all access points (summary) or a specific access point (AP\_name). The access point name, role (RootAP or MeshAP), and model are also shown.
  - The temperature is shown in both Fahrenheit and Celsius.
  - The heater status is ON or OFF.
  - The Ethernet status is UP or DOWN.

**Note**

The battery status appears as N/A (not applicable) in the **show mesh env AP\_name** status display because it is not provided for access points.

```
(Cisco Controller) > show mesh env summary
```

AP Name	Temperature (C/F)	Heater	Ethernet	Battery
SB_RAP1	39/102	OFF	UpDnNANA	N/A
SB_MAP1	37/98	OFF	DnDnNANA	N/A
SB_MAP2	42/107	OFF	DnDnNANA	N/A
SB_MAP3	36/96	OFF	DnDnNANA	N/A

```
(Cisco Controller) > show mesh env SB_RAP1
```

```
AP Name..... SB_RAP1
AP Model..... AIR-LAP1522AG-A-K9
AP Role..... RootAP

Temperature..... 39 C, 102 F
Heater..... OFF
Backhaul..... GigabitEthernet0
GigabitEthernet0 Status..... UP
  Duplex..... FULL
  Speed..... 100
  Rx Unicast Packets..... 988175
  Rx Non-Unicast Packets..... 8563
  Tx Unicast Packets..... 106420
  Tx Non-Unicast Packets..... 17122
GigabitEthernet1 Status..... DOWN
POE Out..... OFF
Battery..... N/A
```

- **show mesh ap summary**—Revised to show the CERT MAC field that shows a MAC address within an AP certificate that can be used to assign a username for external authentication.

```
(Cisco Controller) > show mesh ap summary
```

AP Name	AP Model	BVI MAC	CERT MAC	Hop	Bridge Group Name
R1	LAP1520	00:0b:85:63:8a:10	00:0b:85:63:8a:10	0	y1
R2	LAP1520	00:0b:85:7b:c1:e0	00:0b:85:7b:c1:e0	1	y1
H2	AIR-LAP1522AG-A-K9	00:1a:a2:ff:f9:00	00:1b:d4:a6:f4:60	1	
Number of Mesh APs..... 3					
Number of RAP..... 2					
Number of MAP..... 1					

- **show mesh path**—Displays MAC addresses, access point roles, SNR ratios (dBs) for uplink and downlink (SNRUp, SNRDown) and link SNR for a particular path.

```
(Cisco Controller) > show mesh path mesh-45-rap1
```

AP Name/Radio Mac	Channel	Snr-Up	Snr-Down	Link-Snr	Flags	State
mesh-45-rap1	165	15	18	16	0x86b	UPDATED NEIGH PARENT BEACON

mesh-45-rap1 is a Root AP.

- **show mesh neighbor summary**—Displays summary information about mesh neighbors. Neighbor information includes MAC addresses, parent-child relationships, and uplink and downlink (SNRUp, SNRDown).

```
(Cisco Controller) > show mesh neighbor summary ap1500:62:39:70
```

AP Name/Radio Mac	Channel	Snr-Up	Snr-Down	Link-Snr	Flags	State
mesh-45-rap1	165	15	18	16	0x86b	UPDATED NEIGH PARENT BEACON
00:0B:85:80:ED:D0	149	5	6	5	0x1a60	NEED UPDATE BEACON DEFAULT
00:17:94:FE:C3:5F	149	7	0	0	0x860	BEACON



**Note** After review of the **show mesh** commands above, you should be able to see the relationships between the nodes of your network and verify the RF connectivity by seeing the SNR values for every link.

- **show mesh ap tree**—Displays mesh access points within a tree structure (hierarchy).

```
(Cisco Controller) > show mesh ap tree
R1(0,y1)
|-R2(1,y1)
|-R6(2,y1)
|-H2(1,default)
Number of Mesh APs..... 4
Number of RAP..... 1
Number of MAP..... 3
```

## Viewing Mesh Access Point Details

To view a mesh access point's configuration, enter these commands:

- **show ap config general Cisco\_AP**—Displays system specifications for a mesh access point.

```
(Cisco Controller) > show ap config general aps
Cisco AP Identifier..... 1
Cisco AP Name..... AP5
Country code..... US - United States
Regulatory Domain allowed by Country..... 802.11bg:-AB 802.11a:-AB
AP Country code..... US - United States
AP Regulatory Domain..... 802.11bg:-A 802.11a:-N
Switch Port Number ..... 1
MAC Address..... 00:13:80:60:48:3e
IP Address Configuration..... DHCP
IP Address..... 1.100.163.133
...
Primary Cisco Switch Name..... 1-4404
Primary Cisco Switch IP Address..... 2.2.2.2
Secondary Cisco Switch Name..... 1-4404
Secondary Cisco Switch IP Address..... 2.2.2.2
Tertiary Cisco Switch Name..... 2-4404
Tertiary Cisco Switch IP Address..... 1.1.1.4
```

- **show mesh astools stats [Cisco\_AP]**—Displays anti-stranding statistics for all outdoor mesh access points or a specific mesh access point.

```
(Cisco Controller) > show mesh astools stats

Total No of Aps stranded : 0
> (Cisco Controller) > show mesh astools stats sb_map1

Total No of Aps stranded : 0
```

- **show advanced backup-controller**—Displays configured primary and secondary backup controllers.

```
(Cisco Controller) > show advanced backup-controller
```

```
AP primary Backup Controller ..... controller1 10.10.10.10
AP secondary Backup Controller ..... 0.0.0.0
```

- **show advanced timer**—Displays settings for system timers.

```
(Cisco Controller) > show advanced timer
Authentication Response Timeout (seconds)..... 10
Rogue Entry Timeout (seconds)..... 1300
AP Heart Beat Timeout (seconds)..... 30
AP Discovery Timeout (seconds)..... 10
AP Primary Discovery Timeout (seconds)..... 120
```

- **show ap slots**—Displays slot information for mesh access points.

```
(Cisco Controller) > show ap slots
Number of APs..... 3
AP Name Slots AP Model Slot0 Slot1 Slot2 Slot3
-----
R1 2 LAP1520 802.11A 802.11BG
H1 3 AIR-LAP1521AG-A-K9 802.11BG 802.11A 802.11A
H2 4 AIR-LAP1521AG-A-K9 802.11BG 802.11A 802.11A 802.11BG
```

## Viewing Global Mesh Parameter Settings

Use this command to obtain information on global mesh settings:

- **show mesh config**—Displays global mesh configuration settings.

```
(Cisco Controller) > show mesh config
Mesh Range..... 12000
Backhaul with client access status..... disabled
Background Scanning State..... enabled
Mesh Security
Security Mode..... EAP
External-Auth..... disabled
Use MAC Filter in External AAA server..... disabled
Force External Authentication..... disabled
Mesh Alarm Criteria
Max Hop Count..... 4
Recommended Max Children for MAP..... 10
Recommended Max Children for RAP..... 20
Low Link SNR..... 12
High Link SNR..... 60
Max Association Number..... 10
Association Interval..... 60 minutes
Parent Change Numbers..... 3
Parent Change Interval..... 60 minutes
Mesh Multicast Mode..... In-Out
Mesh Full Sector DFS..... enabled
Mesh Ethernet Bridging VLAN Transparent Mode..... enabled
```

## Viewing Bridge Group Settings

Use these commands to view bridge group settings:

- **show mesh forwarding table**—Shows all configured bridges and their MAC table entries.
- **show mesh forwarding interfaces**—Displays bridge groups and the interfaces within each bridge group. This command is useful for troubleshooting bridge group membership.

## Viewing VLAN Tagging Settings

Use these commands to view VLAN tagging settings:

- **show mesh forwarding VLAN mode**—Shows the configured VLAN Transparent mode (enabled or disabled).
- **show mesh forwarding VLAN statistics**—Displays statistics for the VLAN and the path.
- **show mesh forwarding vlans**—Displays supported VLANs.
- **show mesh ethernet VLAN statistics**—Displays statistics for the Ethernet interface.

## Viewing DFS Details

Use this command to view DFS details:

- **show mesh dfs history**—Displays a history of radar detections by channels and resulting outages.

```
(Cisco Controller) > show mesh dfs history
ap1520#show mesh dfs history
Channel 100 detects radar and is unusable (Time Elapsed: 18 day(s), 22 hour(s), 10
minute(s), 24 second(s)).
Channel is set to 136 (Time Elapsed: 18 day(s), 22 hour(s), 10 minute(s), 24 second(s)).
Channel 136 detects radar and is unusable (Time Elapsed: 18 day(s), 22 hour(s), 9
minute(s), 14 second(s)).
Channel is set to 161 (Time Elapsed: 18 day(s), 22 hour(s), 9 minute(s), 14 second(s)).
Channel 100 becomes usable (Time Elapsed: 18 day(s), 21 hour(s), 40 minute(s), 24
second(s)).
Channel 136 becomes usable (Time Elapsed: 18 day(s), 21 hour(s), 39 minute(s), 14
second(s)).
Channel 64 detects radar and is unusable (Time Elapsed: 0 day(s), 1 hour(s), 20
minute(s), 52 second(s)).
Channel 104 detects radar and is unusable (Time Elapsed: 0 day(s), 0 hour(s), 47
minute(s), 6 second(s)).
Channel is set to 120 (Time Elapsed: 0 day(s), 0 hour(s), 47 minute(s), 6 second(s)).
```

- **show mesh dfs channel *channel number***—Displays a history of radar detections and outages for a specified channel.

```
(Cisco Controller) > show mesh dfs channel 104
ap1520#show mesh dfs channel 104
Channel 104 is available
Time elapsed since radar last detected: 0 day(s), 0 hour(s), 48 minute(s), 11 second(s).
```

## Viewing Public Safety Setting

Use this command to view public safety setting:

- **show mesh public-safety**—Verifies that the 4.8-GHz public safety band is enabled.

```
(Cisco Controller) > show mesh public-safety
Global Public Safety status: enabled
```

## Viewing Security Settings and Statistics

Use this command to view security settings and statistics:

- **show mesh security-stats** *AP\_name*—Shows packet error statistics and a count of failures, timeouts, and successes with respect to associations and authentications as well as reassociations and reauthentications for the specified access point and its child.

```
(Cisco Controller) > show mesh security-stats ap417
```

```
AP MAC : 00:0B:85:5F:FA:F0
Packet/Error Statistics:
-----
Tx Packets 14, Rx Packets 19, Rx Error Packets 0
Parent-Side Statistics:
-----
Unknown Association Requests 0
Invalid Association Requests 0
Unknown Re-Authentication Requests 0
Invalid Re-Authentication Requests 0
Unknown Re-Association Requests 0
Invalid Re-Association Requests 0
Unknown Re-Association Requests 0
Invalid Re-Association Requests 0
Child-Side Statistics:
-----
Association Failures 0
Association Timeouts 0
Association Successes 0
Authentication Failures 0
Authentication Timeouts 0
Authentication Successes 0
Re-Association Failures 0
Re-Association Timeouts 0
Re-Association Successes 0
Re-Authentication Failures 0
Re-Authentication Timeouts 0
Re-Authentication Successes 0
```

## Viewing GPS Status

- See a location summary of all mesh APs by entering this command:  
**show mesh gps location summary**
- See the location information for a particular mesh AP by entering this command:  
**show mesh gps location ap-name**

## Viewing Mesh Statistics for a Mesh Access Point

This section describes how to use the controller GUI or CLI to view mesh statistics for specific mesh access points.



### Note

You can modify the Statistics Timer interval setting on the All APs > Details page of the controller GUI.

## Viewing Mesh Statistics for a Mesh Access Point (GUI)

**Step 1** Choose **Wireless > Access Points > All APs** to open the All APs page.

**Step 2** To view statistics for a specific mesh access point, hover the mouse over the blue drop-down arrow for the desired mesh access point and choose **Statistics**. The **All APs > AP Name > Statistics** page for the selected mesh access point appears. This page shows the role of the mesh access point in the mesh network, the name of the bridge group to which the mesh access point belongs, the backhaul interface on which the access point operates, and the number of the physical switch port. It also displays a variety of mesh statistics for this mesh access point.

**Table 41: Mesh Access Point Statistics**

Statistics	Parameter	Description
Mesh Node Stats	Malformed Neighbor Packets	The number of malformed packets received from the neighbor. Examples of malformed packets include malicious floods of traffic such as malformed or short DNS packets and malformed DNS replies.
	Poor Neighbor SNR Reporting	The number of times the signal-to-noise ratio falls below 12 dB on the backhaul link.
	Excluded Packets	The number of packets received from excluded neighbor mesh access points.
	Insufficient Memory Reporting	The number of insufficient memory conditions.
	Rx Neighbor Requests	The number of broadcast and unicast requests received from the neighbor mesh access points.
	Rx Neighbor Responses	The number of responses received from the neighbor mesh access points.
	Tx Neighbor Requests	The number of unicast and broadcast requests sent to the neighbor mesh access points.
	Tx Neighbor Responses	The number of responses sent to the neighbor mesh access points.
	Parent Changes Count	The number of times a mesh access point (child) moves to another parent.
	Neighbor Timeouts Count	The number of neighbor timeouts.

<b>Statistics</b>	<b>Parameter</b>	<b>Description</b>
<b>Queue Stats</b>	Gold Queue	The average and peak number of packets waiting in the gold (video) queue during the defined statistics time interval.
	Silver Queue	The average and peak number of packets waiting in the silver (best effort) queue during the defined statistics time interval.
	Platinum Queue	The average and peak number of packets waiting in the platinum (voice) queue during the defined statistics time interval.
	Bronze Queue	The average and peak number of packets waiting in the bronze (background) queue during the defined statistics time interval.
	Management Queue	The average and peak number of packets waiting in the management queue during the defined statistics time interval.



Statistics	Parameter	Description
Mesh Node Security Stats	Transmitted Packets	The number of packets transmitted during security negotiations by the selected mesh access point.
	Received Packets	The number of packets received during security negotiations by the selected mesh access point.
	Association Request Failures	The number of association request failures that occur between the selected mesh access point and its parent.
	Association Request Timeouts	The number of association request timeouts that occur between the selected mesh access point and its parent.
	Association Requests Successful	The number of successful association requests that occur between the selected mesh access point and its parent.
	Authentication Request Failures	The number of failed authentication requests that occur between the selected mesh access point and its parent.
	Authentication Request Timeouts	The number of authentication request timeouts that occur between the selected mesh access point and its parent.
	Authentication Requests Successful	The number of successful authentication requests between the selected mesh access point and its parent.
	Reassociation Request Failures	The number of failed reassociation requests between the selected mesh access point and its parent.
	Reassociation Request Timeouts	The number of reassociation request timeouts between the selected mesh access point and its parent.
	Reassociation Requests Successful	The number of successful reassociation requests between the selected mesh access point and its parent.
	Reauthentication Request Failures	The number of failed reauthentication requests between the selected mesh access point and its parent.
	Reauthentication Request Timeouts	The number of reauthentication request timeouts that occur between the selected mesh access point and its parent.
	Reauthentication Requests Successful	The number of successful reauthentication requests that occur between the selected mesh access point and its parent.
	Unknown Association Requests	The number of unknown association requests received by the parent mesh access point from its child. The unknown association requests often occur when a child is an unknown neighbor mesh access point.

Statistics	Parameter	Description
	Invalid Association Requests	The number of invalid association requests received by the parent mesh access point from the selected child mesh access point. This state may occur when the selected child is a valid neighbor but is not in a state that allows association.
Mesh Node Security Stats (continued)	Unknown Reauthentication Requests	The number of unknown reauthentication requests received by the parent mesh access point node from its child. This state may occur when a child mesh access point is an unknown neighbor.
	Invalid Reauthentication Requests	The number of invalid reauthentication requests received by the parent mesh access point from a child. This state may occur when a child is a valid neighbor but is not in a proper state for reauthentication.
	Unknown Reassociation Requests	The number of unknown reassociation requests received by the parent mesh access point from a child. This state may occur when a child mesh access point is an unknown neighbor.
	Invalid Reassociation Requests	The number of invalid reassociation requests received by the parent mesh access point from a child. This state may occur when a child is a valid neighbor but is not in a proper state for reassociation.

## Viewing Mesh Statistics for an Mesh Access Point (CLI)

Use these commands to view mesh statistics for a specific mesh access point using the controller CLI:

- To view packet error statistics, a count of failures, timeouts, and successes with respect to associations and authentications, and reassociations and reauthentications for a specific mesh access point, enter this command:

```
show mesh security-stats AP_name
```

Information similar to the following appears:

```
AP MAC : 00:0B:85:5F:FA:F0
Packet/Error Statistics:
-----
x Packets 14, Rx Packets 19, Rx Error Packets 0

Parent-Side Statistics:
-----
Unknown Association Requests 0
Invalid Association Requests 0
Unknown Re-Authentication Requests 0
Invalid Re-Authentication Requests 0
Unknown Re-Association Requests 0
Invalid Re-Association Requests 0
Unknown Re-Association Requests 0
```

```

Invalid Re-Association Requests 0

Child-Side Statistics:
-----
Association Failures 0
Association Timeouts 0
Association Successes 0
Authentication Failures 0
Authentication Timeouts 0
Authentication Successes 0
Re-Association Failures 0
Re-Association Timeouts 0
Re-Association Successes 0
Re-Authentication Failures 0
Re-Authentication Timeouts 0
Re-Authentication Successes 0

```

- To view the number of packets in the queue by type, enter this command:

```
show mesh queue-stats AP_name
```

Information similar to the following appears:

Queue Type	Overflows	Peak length	Average length
Silver	0	1	0.000
Gold	0	4	0.004
Platinum	0	4	0.001
Bronze	0	0	0.000
Management	0	0	0.000

Overflows—The total number of packets dropped due to queue overflow.

Peak Length—The peak number of packets waiting in the queue during the defined statistics time interval.

Average Length—The average number of packets waiting in the queue during the defined statistics time interval.

## Viewing Neighbor Statistics for a Mesh Access Point

This section describes how to use the controller GUI or CLI to view neighbor statistics for a selected mesh access point. It also describes how to run a link test between the selected mesh access point and its parent.

### Viewing Neighbor Statistics for a Mesh Access Point (GUI)

- 
- Step 1** Choose **Wireless > Access Points > All APs** to open the All APs page.
- Step 2** To view neighbor statistics for a specific mesh access point, hover the mouse over the blue drop-down arrow for the desired mesh access point and choose **Neighbor Information**. The All APs > *Access Point Name* > Neighbor Info page for the selected mesh access point appears.
- This page lists the parent, children, and neighbors of the mesh access point. It provides each mesh access point's name and radio MAC address.
- Step 3** To perform a link test between the mesh access point and its parent or children, follow these steps:

- a) Hover the mouse over the blue drop-down arrow of the parent or desired child and choose **LinkTest**. A pop-up window appears.
- b) Click **Submit** to start the link test. The link test results appear on the Mesh > LinkTest Results page.
- c) Click **Back** to return to the **All APs > Access Point Name > Neighbor Info** page.

**Step 4**

To view the details for any of the mesh access points on this page, follow these steps:

- a) Hover the mouse over the blue drop-down arrow for the desired mesh access point and choose **Details**. The **All APs > Access Point Name > Link Details > Neighbor Name** page appears.
- b) Click **Back** to return to the **All APs > Access Point Name > Neighbor Info** page.

**Step 5**

To view statistics for any of the mesh access points on this page, follow these steps:

- a) Hover the mouse over the blue drop-down arrow for the desired mesh access point and choose **Stats**. The **All APs > Access Point Name > Mesh Neighbor Stats** page appears.
- b) Click **Back** to return to the **All APs > Access Point Name > Neighbor Info** page.

## Viewing the Neighbor Statistics for a Mesh Access Point (CLI)

Use these commands to view neighbor statistics for a specific mesh access point using the controller CLI.

- To view the mesh neighbors for a specific mesh access point, enter this command:

```
show mesh neigh {detail | summary} AP_Name
```

Information similar to the following appears when you request a summary display:

AP Name/Radio Mac	Channel	Snr-Up	Snr-Down	Link-Snr	Flags	State
mesh-45-rap1	165	15	18	16	0x86b	UPDATED NEIGH PARENT BEACON
00:0B:85:80:ED:D0	149	5	6	5	0x1a60	NEED UPDATE BEACON DEFAULT
00:17:94:FE:C3:5F	149	7	0	0	0x860	BEACON

- To view the channel and signal-to-noise ratio (SNR) details for a link between a mesh access point and its neighbor, enter this command:

```
show mesh path AP_Name
```

Information similar to the following appears:

AP Name/Radio Mac	Channel	Snr-Up	Snr-Down	Link-Snr	Flags	State
mesh-45-rap1	165	15	18	16	0x86b	UPDATED NEIGH PARENT BEACON

mesh-45-rap1 is a Root AP.

- To view the percentage of packet errors for packets transmitted by the neighbor mesh access point, enter this command:

```
show mesh per-stats AP_Name
```

Information similar to the following appears:

```
Neighbor MAC Address 00:0B:85:5F:FA:F0
Total Packets transmitted: 104833
Total Packets transmitted successfully: 104833
```

```
Total Packets retried for transmission: 33028
```

```
Neighbor MAC Address 00:0B:85:80:ED:D0  
Total Packets transmitted: 0  
Total Packets transmitted successfully: 0  
Total Packets retried for transmission: 0
```

```
Neighbor MAC Address 00:17:94:FE:C3:5F  
Total Packets transmitted: 0  
Total Packets transmitted successfully: 0  
Total Packets retried for transmission: 0
```



---

**Note** Packet error rate percentage =  $1 - (\text{number of successfully transmitted packets} / \text{number of total packets transmitted})$ .

---





# Troubleshooting

This chapter describes troubleshooting information and contains the following section:

- [Installation and Connections, page 211](#)

## Installation and Connections

- Step 1** Connect the mesh access point that you want to be the RAP to the controller.
- Step 2** Deploy the radios (MAP) at the desired locations.
- Step 3** On the controller CLI, enter the **show mesh ap summary** command to see all MAPs and RAPs on the controller.

*Figure 82: Show Mesh AP Summary Page*

```
(Cisco Controller) >show mesh ap summary
```

AP Name	AP Model	DVI MAC	CERT MAC	Hop	Bridge Group Name
1522_Rap_96	AIR-LAP1521AG-A-K9	00:1d:e5:e8:96:00	00:13:1a:cf:4d:dc	0	10a_kmesh
1510_map1	LAP1510	00:0b:85:70:75:bd	00:0b:85:70:75:bd	1	10a_kmesh
1524_Rap	AIR-LAP1522AG-A-K9	00:1a:a2:ff:ff:00	00:1b:d4:a6:f4:1c	0	10a_kmesh
1522_map1_95	AIR-LAP1521AG-A-K9	00:1d:e5:e8:95:00	00:13:1a:cf:4d:fd	1	10a_kmesh
1510_map2	OAP1500	00:0b:85:60:92:80	00:0b:85:60:92:80	2	10a_kmesh
1510_map3	OAP1500	00:0b:85:63:77:00	00:0b:85:63:77:00	3	10a_kmesh
1524_map1		00:1e:14:49:1b:00	00:1e:14:49:1b:00	1	10a_kmesh
1522_map3_97	AIR-LAP1521AG-A-K9	00:1d:e5:e8:97:00	00:13:1a:cf:4b:fc	1	10a_kmesh
1522_map2_94	AIR-LAP1521AG-A-K9	00:1d:e5:e8:94:00	00:13:1a:cf:4d:ed	2	10a_kmesh

```
Number of Mesh APs..... 9 Number of RAPs..... 2 Number of  
MAPs..... 7
```

273951

**Step 4** On the controller GUI, click **Wireless** to see the mesh access point (RAP and MAP) summary.

**Figure 83: All APs Summary Page**

The screenshot shows a web interface titled "All APs". At the top, there is a search bar labeled "Search by AP MAC" with a "Search" button. Below the search bar is a table with the following columns: AP Name, AP MAC, AP Up Time, Admin Status, Operational Status, AP Mode, and Certificate Type. The table contains seven rows of data, each representing a different mesh access point. The AP names are iMeshRap1, H3RAP1, H3MAP3, H3MAP1, H3MAP2, HPRAP1, and HPMAP1. The AP MAC addresses, up times, admin statuses, operational statuses, and AP modes are also listed. The certificate type for all APs is MIC. A vertical number "273952" is visible on the right side of the table.

AP Name	AP MAC	AP Up Time	Admin Status	Operational Status	AP Mode	Certificate Type
<a href="#">iMeshRap1</a>	00:19:30:76:32:72	0 d, 22 h 24 m 25 s	Enable	REG	Local	MIC
<a href="#">H3RAP1</a>	00:1d:71:0d:e1:00	0 d, 22 h 12 m 37 s	Enable	REG	Bridge	MIC
<a href="#">H3MAP3</a>	00:1d:71:0d:d5:00	0 d, 22 h 05 m 04 s	Enable	REG	Bridge	MIC
<a href="#">H3MAP1</a>	00:1d:71:0c:f4:00	0 d, 22 h 04 m 48 s	Enable	REG	Bridge	MIC
<a href="#">H3MAP2</a>	00:1d:71:0c:f0:00	0 d, 22 h 04 m 53 s	Enable	REG	Bridge	MIC
<a href="#">HPRAP1</a>	00:1e:14:48:43:00	0 d, 05 h 35 m 24 s	Enable	REG	Bridge	MIC
<a href="#">HPMAP1</a>	00:1b:d4:a7:78:00	0 d, 22 h 04 m 25 s	Enable	REG	Bridge	MIC

**Step 5** Click **AP Name** to see the details page and then select the **Interfaces** tab to see the active radio interfaces. The radio slot in use, radio type, subband in use, and operational status (UP or DOWN) are summarized.

- AP1524 supports 3 radio slots: slot 0—2.4 GHz, slot 1—5.8 GHz, and slot 2—4.9 GHz
- AP1522 supports 2 radio slots: slot 0—2.4 GHz and slot 1—4.9 to 5.8 GHz

If you have more than one controller connected to the same mesh network, then you must specify the name of the primary controller using global configuration for every mesh access point or specify the primary controller on every node, otherwise the least loaded controller is the preferred controller. If the mesh access points were previously connected to a controller, they already have learned a controller’s name.

After configuring the controller name, the mesh access point reboots.

**Step 6** Click **Wireless > AP Name** to check the mesh access point’s primary controller on the AP details page.

## Debug Commands

The following two commands are very helpful to see the messages being exchanged between mesh access points and the controller.

```
(Cisco Controller) > debug capwap events enable
(Cisco Controller) > debug disable-all
```

You can use the **debug** command to see the flow of packet exchanges that occur between the mesh access point and the controller. The mesh access point initiates the discovery process. An exchange of credentials takes place during the join phase to authenticate that the mesh access point is allowed to join the mesh network.

Upon a successful join completion, the mesh access point sends a CAPWAP configuration request. The controller responds with a configuration response. When a Configure Response is received from the controller, the mesh access point evaluates each configuration element and then implements them.



## Remote Debug Commands

You can log on to the mesh access point console for debugging either through a direct connection to the AP console port or through the remote debug feature on the controller.

To invoke remote debug on the controller, enter the following commands:

```
(Cisco Controller) > debug ap enable ap-name
(Cisco Controller) > debug ap command command ap-name
```

## AP Console Access

AP1500s have a console port. A console cable is not shipped with the mesh access point. For the 1550 series access points, console ports are easily accessible and you need not open the access point box. But, for the 1520 series, you must open the hinged side of the mesh access point to access the console port and then bring the cable outside from the Auxiliary port to connect it to the laptop.

The AP1500s have console access security embedded in the code to prevent unauthorized access on the console port and provide enhanced security.

The **login ID** and **password** for console access are configured from the controller. You can use the following commands to push the username/password combination to the specified mesh access point or all access points:

```
<Cisco Controller> config ap username cisco password cisco ?
all          Configures the Username/Password for all connected APs.
<Cisco AP>  Enter the name of the Cisco AP.
```

```
<Cisco Controller> config ap username cisco password cisco all
```

You must verify whether the username/password pushed from the controller is used as *user-id* and *password* on the mesh access point. It is a nonvolatile setting. Once set, a *login ID* and *password* are saved in the private configuration of the mesh access point.

Once you have a successful login, the trap is sent to the Cisco Prime Infrastructure. If a user fails to log on three times consecutively, login failure traps are sent to the controller and Cisco Prime Infrastructure.



**Caution**

A mesh access point must be reset to the factory default settings before moving from one location to another.

**Hardware Reset**

Perform a hardware reset on this AP

Reset AP Now

**Set to Factory Defaults**

Clear configuration on this AP and reset it to factory defaults

Clear Config

206711

## Cable Modem Serial Port Access From an AP

Commands can be sent to the cable modem from the privileged mode of the CLI. Use the command to take a text string and send it to the cable modem UART interface. The cable modem interprets the text string as one of its own commands. The cable modem response is captured and displayed on the Cisco IOS console. Up to 9600 characters are displayed from the cable modem. Any text that is greater than 4800 characters is truncated.

The modem commands are only operational on mesh APs that have devices connected to the UART port originally intended for the cable modem. If the commands are used on a mesh AP that does not have a cable modem (or any other device connected to the UART), the commands are accepted, however, but they do not produce any returned output. No errors are explicitly flagged.

### Configuration

Enter the following command from the privileged mode of the MAP:

```
AP#send cmodem timeout-value modem-command
```

The modem command is any command or text to send to the cable modem. The range of timeout value is 1 to 300 seconds. However, if the captured data equals 9600 characters, any text beyond that is truncated and the response, irrespective of the timeout value and is immediately displayed on the AP console.

**Figure 84: Cable Modem Console Access Command**

```
RAP-CM-N1#send ?
*          All tty lines
<0-16>    Send a message to a specific line
cmodem    Enter cable modem command
console   Primary terminal line
log       Logging destinations
vty      Virtual terminal

RAP-CM-N1#send cmodem ?
LINE     Enter modem command string
<cr>
```

279059

**Figure 85: Cable Modem Console Access Command**

```
RAP-CM-N1#send cmodem ls
ls
CM>
CM> ls

!                ?                REM                cd                dir
find_command     help                history            instances         ls
man              pwd                sleep             syntax            system_time
usage
----
mbufShow        memShow            mutex_debug       ping              read_memory
reset           routeShow          run_app           shell             stackShow
start_idle_profiling stop_idle_profiling taskDelete
taskInfo        taskPrioritySet    taskResume        taskShow          taskSuspend
taskTrace       usfsShow           version           write_memory      zone
----
[HeapManager] [SA] [cm_hal] [docsis_ctl] [embedded_target] [enet_hal]
[event_log] [flash] [forwarder] [ip_hal] [msgLog] [non-vol] [pingHelper]
[snmp] [snoop] [usb_hal]

CM>
RAP-CM-N1#send cmodem cd docsis
cd
CM>
CM> cd docsis
CM> cd docsis

Active Command Table: CM DOCSIS Control Thread Commands (docsis_ctl)

CM -> docsis_ctl

CM/DocsisCtl>
RAP-CM-N1#
```

279060

**Caution**

The question mark (?) and the exclamation point (!) should not be used in the **send cmodem** command. These characters have immediate interpreted use in the Cisco IOS CLI. Therefore, they cannot be sent to the modem.

**Enabling the Cable Modem Console Port**

By default, the Cable Modem console port is disabled. This is to prevent users from accessing the console through their residential cable modem. In the AP1552C model, the cable modem console is connected directly to the access point. The console port is required for signaling between the AP and the cable modem. There are two methods to enable the cable modem console port, either through SNMP or by adding the command to the configuration .cm file on the CMTS.

**Note**

For the AP1552C and AP1552CU, the cable modem must be enabled.

- Enable the cable modem console port through SNMP by entering this command to the IP address of the cable modem:

```
snmpset -c private IP_ADDRESS cmConsoleMode.0 i N
```

Using the OID, enter this command:

```
snmpset -c private IP_ADDRESS
1.3.6.1.4.1.1429.77.1.4.7.0 i N
```

Where IP\_ADDRESS is any IPv4 address and N is an integer, 2 to enable read-write, 1 for read-only, or 0 to disable.

Example:

```
snmpset -c private 209.165.200.224 cmConsoleMode.0 i 2
```

- Enable the cable modem console port through the configuration file. The configuration file (with a .cm extension) is loaded into the cable modem head end. It is pushed to the cable modem as part of the join process. Enter the following line to the cable modem configuration file:

```
SA-CM-MIB::cmConsoleMode.0 = INTEGER: readWrite(2)
```

Using the OID, enter this line:

```
SA-CM-MIB::cmConsoleMode.0 = INTEGER: readWrite(2)
```

**Resetting the AP1552C Through the Cable Modem**

An AP1552C can be reset by entering an SNMP command to the Cable Modem, which resides inside the access point. For this feature to work, you must enable the cable modem console port.

Reset the AP by entering this snmpset command:

```
Snmpset -v2c -c public IP ADDRESS 1.3.6.1.4.1.1429.77.1.3.17.0 i 1
```

Where the IP ADDRESS is the IPv4 address of the cable modem.

## Mesh Access Point CLI Commands

You can enter these commands directly on the mesh access point using the AP console port or you can use the remote debug feature from the controller:

```
HJRAP1#show mesh ?
adjacency MESH Adjacency
astools MESH Anti-strand tools
backhaul MESH backhaul
channel MESH channel
config MESH config parameter
dfs MESH dfs Information
ethernet show mesh ethernet bridging
forwarding MESH Forwarding
inventory platform inventory
linktest MESH linktest stats
module MESH module detail
mperf MESH BM tool
security MESH Security show
simulation MESH simulated configuration
status MESH status
```

273945

```
HJRAP1#show mesh config
rtsThreshold11a 0, aifs 0, caMin 0, caMax 0
rtsThreshold11b 0, aifs 0, caMin 0, caMax 0
huRetries 0, linkRate 0 qDepth 0
802.11 MAC Client Statistics Push Interval: 3
range parameter: 12000
mesh security mode: 0
Universal Client Access: disabled
public safety global state: enabled
Battery backup state: enabled
multicast mode: in-out
Full Sector DFS: enabled
```

273946

```
HJRAP1#show capwap client rob
AdminState : ADMIN_ENABLED
SwVer : 5.2.95.0
NumFilledSlots : 2
Name : HJRAP1
Location : default location
MwanName : SEVT-CONTROLLER
MwanApMgrIp : 209.165.200.227
MwanHwVer : 0.0.0.0
ApMode : Bridge
ApSubMode : Not Configured
OperationState : UP
CAPWAP Path MTU : 1485
LinkAuditing : disabled
ApRole : RootAP
ApBackhaul : 802.11a
ApBackhaulChannel : 5805
ApBackhaulSlot : 1
ApBackhaul11gEnabled : 0
ApBackhaulTxRate : 24000
Ethernet Bridging State : 0
Public Safety State : enabled
```

273947

```
HJRAP1#show mesh adjacency ?
all MESH Adjacency All
child MESH Adjacency Child
parent MESH Adjacency Parent
```

273948

```
HJMap4#show mesh status
show MESH Status
MeshAP in state Maint
Uplink Backbone: Virtual-Dot11Radio0
Downlink Backbone: Dot11Radio1
Configured BGN: HuckJr
rxNeighReq 129790 rxNeighResp 66976 txNeighReq 33938 txNeighResp 129790
rxNeighResp 1147275 txNeighUpd 202060
nextChan 0 nextant 0 downAnt 0 downChan 0 curAnts 0
nextNeigh 1, malformedNeighPackets 4, poorNeighSnr 1
blacklistPackets 0, insufficientMemory 0, authenticationFailures 0
Parent Changes 3, Neighbor Timeouts 0
Vector through 0017.94fe.c3bf:
Vector ease 1 -1, FWD: 0017.94fe.c3bf
```

273949

```
HJMap4#show mesh forwarding link
Current mesh links:
-----
End Point : 0017.94fe.c3bf
Adjacency : Exists
Channel : 161 on Dot11Radio1
Type : 2
State : 4
Bundle : member
Bridge : 1
swidb : Virtual-Dot11Radio0
port state : OPEN
```

273950

## Mesh Access Point Debug Commands

You can enter these commands directly on the mesh access point using the AP console port or you can use the remote debug feature from the controller.

- **debug mesh ethernet bridging**—Debugs Ethernet bridging.
- **debug mesh ethernet config**—Debugs access and trunk port configuration associated with VLAN tagging.
- **debug mesh ethernet registration**—Debugs the VLAN registration protocol. This command is associated with VLAN tagging.
- **debug mesh forwarding table**—Debugs the forwarding table containing bridge groups.
- **debugs mesh forwarding packet bridge-group**—Debugs the bridge group configuration.

## Defining Mesh Access Point Roles

By default, the AP1500s are shipped with a radio role set to MAP. Therefore, you must change the radio role on a mesh access point for it to function as RAP.

You can change this configuration on the mesh access point by statically setting them as rooftop access points or mesh access points with the **config ap role** *{rootAP | mesh AP | default}* command:

To change the radio role can also be changed using the GUI, follow these steps:

- 
- Step 1** Choose **Wireless > Access Points > All APs** to open the All APs page.
- Step 2** Click the name of the mesh access point that you want to change. Click the **Mesh** tab.
- Step 3** From the AP Role drop-down list, choose **MeshAP** or **RootAP** to specify this mesh access point as a MAP or RAP, respectively.
- Step 4** Click **Apply** to commit your changes. The mesh access point reboots.
- Step 5** Click **Save Configuration** to save your changes.
- Note** We recommend a Fast Ethernet connection between the MAP and controller when changing from a MAP to RAP. After a RAP-to-MAP conversion, the MAP's connection to the controller is a wireless backhaul rather than a Fast Ethernet connection. It is the responsibility of the user to ensure that the Fast Ethernet connection of the RAP being converted is disconnected before the MAP starts up so that the MAP can join over the air.
- 

## Backhaul Algorithm

A **backhaul** is used to create only the wireless connection between mesh access points.

The backhaul interface by default is 802.11a. You cannot change the backhaul interface to 802.11b/g.

The 24-Mbps data rate is selected by default for AP1500s.

The backhaul algorithm has been designed to fight against stranded mesh access point conditions. This algorithm also adds a high-level of resiliency for each mesh node.

The algorithm can be summarized as follows:

- A MAP always sets the Ethernet port as the **primary backhaul** if it is UP; otherwise, it is the 802.11a radio (this feature gives the network administrator the ability to configure it as a RAP the first time and recover it in-house). For fast convergence of the network, we recommend that you do not connect any Ethernet device to the MAP for its initial joining to the mesh network.
- A MAP failing to connect to a WLAN controller on an Ethernet port that is UP, sets the 802.11a radio as the **primary backhaul**. Failing to find a neighbor or failing to connect to a WLAN controller via any neighbor on the 802.11a radio causes the **primary backhaul** to be UP on the Ethernet port again. A MAP gives preference to the parent which has the same BGN.
- A MAP connected to a controller over an Ethernet port does not build a mesh topology (unlike a RAP).
- A RAP always sets the Ethernet port as the **primary backhaul**.
- If the Ethernet port on a RAP is DOWN, or a RAP fails to connect to a controller on an Ethernet port that is UP, the 802.11a radio is set as the **primary backhaul**. Failing to find a neighbor or failing to connect to a controller via any neighbor on the 802.11a radio makes the RAP go to the SCAN state after 15 minutes and starts with the Ethernet port first.

Keeping the roles of mesh nodes distinct using the above algorithm greatly helps to avoid a mesh access point from being in an unknown state and becoming stranded in a live network.

## Passive Beacons (Anti-Stranding)

When enabled, passive beacons allows a stranded mesh access point to broadcast its debug messages over-the-air using a 802.11b/g radio. A neighboring mesh access point that is listening to the stranded mesh access point and has a connection to a controller, can pass those messages to the controller over CAPWAP. Passive beacons prevents a mesh access point that has no wired connection from being stranded.

Debug logs can also be sent as distress beacons on a nonbackhaul radio so that a neighboring mesh access point can be dedicated to listen for the beacons.

The following steps are automatically initiated at the controller when a mesh access point loses its connection to the controller:

- Identifies the MAC address of a stranded mesh access point
- Finds a nearby neighbor that is CAPWAP connected
- Sends commands through remote debug
- Cycles channels to follow the mesh access point

You only have to know the MAC address of the stranded AP to make use of this feature.

A mesh access point is considered stranded if it goes through a lonely timer reboot. When the lonely timer reboot is triggered, the mesh access point, which is now stranded, enables passive beacons, the anti-stranding feature.

This feature can be divided into three parts:

- Strand detection by stranded mesh access point
- Beacons sent out by stranded mesh access point
  - Latch the 802.11b radio to a channel (1,6,11)
  - Enable debugs
  - Broadcast the standard debug messages as distress beacons
  - Send Latest Crash info file
- Receive beacons (neighboring mesh access point with remote debugging enabled)

Deployed mesh access points constantly look for stranded mesh access points. Periodically, mesh access points send a list of stranded mesh access points and SNR information to the controller. The controller maintains a list of the stranded mesh access points within its network.

When the **debug mesh astools troubleshoot mac-addr start** command is entered, the controller runs through the list to find the MAC address of the stranded mesh access point.

A message is sent to the best neighbor to start listening to the stranded access point. The listening mesh access point gets the distress beacons from the stranded mesh access point and sends it to the controller.

Once a mesh access point takes the role of a listener, it does not purge the stranded mesh access point from its internal list until it stops listening to the stranded mesh access point. While a stranded mesh access point is being debugged, if a neighbor of that mesh access point reports a better SNR to the controller than the current listener by some percentage, then the listener of the stranded mesh access point is changed to the new listener (with better SNR) immediately.



End-user commands are as follows:

- **config mesh astools [enable | disable]**—Enables or disables the astools on the mesh access points. If disabled, APs no longer sends a stranded AP list to the controller.
- **show mesh astools stats**—Shows the list of stranded APs and their listeners if they have any.
- **debug mesh astools troubleshoot mac-addr start**—Sends a message to the best neighbor of the *mac-addr* to start listening.
- **debug mesh astools troubleshoot mac-addr stop**—Sends a message to the best neighbor of the *mac-addr* to stop listening.
- **clear mesh stranded [all | mac of b/g radio]**—Clears stranded AP entries.

The controller console is swamped with debug messages from stranded APs for 30 minutes.

## Dynamic Frequency Selection

This section describes the Dynamic Frequency Selection (DFS) functionality in RAP and MAP.

### DFS in RAP

The RAP performs the following steps as a response to radar detection:

- 1 The RAP sends a message to the controller that the channel is infected with radar. The channel is marked as infected on the RAP and on the controller.
- 2 The RAP blocks the channel for 30 minutes. This 30-minute period is called the nonoccupancy period.
- 3 The controller sends a TRAP, which indicates that the radar has been detected on the channel. A TRAP remains until the nonoccupancy period expires.
- 4 The RAP has 10 seconds to move away from the channel. This period is called the channel move time, which is defined as the time for the system to clear the channel and is measured from the end of the radar burst to the end of the final transmission on the channel.
- 5 The RAP enters the quiet mode. In the quiet mode, the RAP stops data transmissions. Beacons are still generated and probe responses are still delivered. The quiet mode exists until the channel move time is over (10 seconds).
- 6 The controller picks up a new random channel and sends the channel information to the RAP.
- 7 The RAP receives the new channel information and sends channel change frames (unicast, encrypted) to the MAP, and each MAP sends the same information to its lower children down the sector. Each mesh access point sends the channel change frames once every 100 msecs for a total of five times.
- 8 The RAP tunes to the new channel and enters into the silent mode. During the silent mode, only the receiver is ON. The RAP keeps scanning the new channel for any radar presence for 60 seconds. This process is called channel availability check (CAC).
- 9 The MAP tunes to the new channel and enters into the silent mode. During the silent mode, only the receiver is ON. The MAP keeps scanning the new channel for any radar presence for 60 seconds.
- 10 If radar is not detected, the RAP resumes full functionality on this new channel and the whole sector tunes to this new channel.

## DFS in MAP

The MAP performs the following steps as a response to radar detection:

- 1 The MAP sends a radar seen indication to the parent and ultimately to the RAP indicating that the channel is infected. The RAP sends this message to the controller. The message appears to be coming from the RAP. The MAP, RAP, and controller mark the channel as infected for 30 minutes.
- 2 The MAP blocks the channel for 30 minutes. This 30-minute period is called the nonoccupancy period.
- 3 The controller sends a TRAP, which indicates that the radar has been detected on the channel. The TRAP remains until the nonoccupancy period expires.
- 4 The MAP has 10 seconds to move away from the channel. This is called the channel move time, which is defined as the time for the system to clear the channel and is measured from the end of the radar burst to the end of the final transmission on the channel.
- 5 The MAP enters the quiet mode. In the quiet mode, the MAP stops data transmissions. Beacons are still generated and probe responses are still delivered. The quiet mode exists until the channel move time is over (10 seconds).
- 6 The controller picks up a new random channel and sends the channel to the RAP.
- 7 The RAP receives the new channel information and sends channel change frames (unicast, encrypted) to a MAP, and each MAP sends the same information to its lower children down the sector. Each mesh access point sends the channel change frames once every 100 msecs for a total of five times.
- 8 Each mesh access point tunes to the new channel and enters into the silent mode. During the silent mode, only the receiver is ON. There is no packet transmission. An AP keeps scanning the new channel for any radar presence for 60 seconds. This process is called the channel availability check (CAC). The MAP should not disconnect from the controller. The network should remain stable during this one-minute period.

DFS functionality allows a MAP that detects a radar signal to transmit that up to the RAP, which then acts as if it has experienced radar and moves the sector. This process is called the coordinated channel change. This functionality can be turned on or off on the controller. The coordinated channel change is enabled by default.

To enable DFS, enter the following command:

```
(Cisco Controller) > config mesh full-sector-dfs enable
```

To verify that DFS is enabled on the network, enter the following command:

```
(Cisco Controller) > show network summary
```



### Note

A MAP that detects radar should send a message to the RAP, unless the parent has a different BGN, in which case it does not send messages for a coordinated sector change. Instead, the MAP reenters the SCAN state and searches on nonradar seen channels for a new parent.



### Note

Ensure that none of your mesh access points are using a default BGN.



**Note**

A repeated radar event on the MAP (radar triggers once, and then almost immediately again), causes the MAP to disconnect.

## Preparation in a DFS Environment

This section describes how to prepare in a DFS environment:

- To verify that your controller is set to the correct country domain, enter the following command:

```
(Cisco Controller) > show country
```

- To check the mesh access point country and the channel setting on the controller, enter the following command:

```
(Cisco Controller)> show ap config 802.11a ap-name
```

- To identify channels available for mesh, enter the following command:

```
(Cisco Controller)> show ap config 802.11a ap-name
```

Look for the allowed channel list.

```
Allowed Channel List..... 100,104,108,112,116,120,124,  
..... 128,132,136,140
```

- To identify channels available for mesh on the AP console (or use remote debug from the controller, enter the following command:

```
ap1520-rap # show mesh channels  
  
HW: Dot11Radio1, Channels:  
100, 104, 108, 112, 116, 120, 124, 128, 132, 136, 140
```

An asterisk next to a channel indicates that radar has been seen on the channel.

- To invoke remote debug, enter the following commands:

```
(Cisco Controller) > debug ap enable ap-name  
(Cisco Controller) > debug ap command command ap-name
```

- Debug commands to see radar detection and past radar detections on the DFS channel are as follows:

```
show mesh dfs channel channel-number  
show mesh dfs history
```

Information similar to the following appears.

```
ap1520-rap # show mesh dfs channel 132  
  
Channel 132 is available
```

Time elapsed since radar last detected: 0 day(s), 7 hour(s), 6 minute(s), 51 second(s).

The RAP should be run through the channels to determine whether there is active radar on each of the channels.

```
ap1520-rap # show mesh dfs channel 132
```

```
Radar detected on channel 132, channel becomes unusable (Time Elapsed: 0 day(s), 7
hour(s), 7 minute(s), 11 second(s)).
Channel is set to 100 (Time Elapsed: 0 day(s), 7 hour(s), 7 minute(s), 11 second(s)).
Radar detected on channel 116, channel becomes unusable (Time Elapsed: 0 day(s), 7
hour(s), 6 minute(s), 42 second(s)).
Channel is set to 64 (Time Elapsed: 0 day(s), 7 hour(s), 6 minute(s), 42 second(s)).
Channel 132 becomes usable (Time Elapsed: 0 day(s), 6 hour(s), 37 minute(s), 10
second(s)).
Channel 116 becomes usable (Time Elapsed: 0 day(s), 6 hour(s), 36 minute(s), 42
second(s)).
```

## Monitoring DFS

The DFS history should be run every morning or more frequently to detect the radar. This information does not get erased and is stored on the mesh access point flash. Therefore, you only need to match the times.

```
ap1520-rap # show controller dot11Radio 1
```

Information similar to the following appears:

```
interface Dot11Radio1
Radio Hammer 5, Base Address 001c.0e6c.9c00, BBlock version 0.00, Software version 0.05.30
Serial number: FOC11174XCW
Number of supported simultaneous BSSID on Dot11Radio1: 16
Carrier Set: ETSI (OFDM) (EU) (-E)
Uniform Spreading Required: Yes
Current Frequency: 5540 MHz Channel 108 (DFS enabled)
Allowed Frequencies: *5500(100) *5520(104) *5540(108) *5560(112) *5580(116) *560
0(120) *5620(124) *5640(128) *5660(132) *5680(136) *5700(140)
* = May only be selected by Dynamic Frequency Selection (DFS)
Listen Frequencies: 5180(36) 5200(40) 5220(44) 5240(48) 5260(52) 5280(56) 5300(6
0) 5320(64) 5500(100) 5520(104) 5540(108) 5560(112) 5580(116) 5660(132) 5680(136
) 5700(140) 5745(149) 5765(153) 5785(157) 5805(161) 5825(165) 4950(20) 4955(21)
4960(22) 4965(23) 4970(24) 4975(25) 4980(26)
```



### Note

An asterisk indicates that this channel has DFS enabled.

## Frequency Planning

Use alternate adjacent channels in adjacent sectors. If you have two RAPs deployed at the same location, you must leave one channel in between.

Weather radars operate within the 5600- to 5650-MHz band, which means that channels 124 and 128 might be affected, but also channels 120 and 132 might suffer from weather radar activity.

If the mesh access point does detect radar, the controller and the mesh access point both will retain the channel as the configured channel. The controller retains it in volatile memory associated with the mesh access point, and the mesh access point has it stored in its flash as configuration. After the 30 minute quiet period, the controller returns the mesh access point to the static value, regardless of whether the mesh access point has

been configured with a new channel or not. In order to overcome this, configure the mesh access point with a new channel, and reboot the mesh access point.

Once radar is reliably detected on a channel, that channel, and the two surrounding channels, should be added to the RRM exclusion list, as follows:

```
(Cisco Controller) > config advanced 802.11a channel delete channel
```

A mesh access point goes to a new channel that is picked by RRM, and it does not consider excluded channels.

If a radar is detected on channel 124, for instance, channels 120, 124, and 128 should be added to the exclusion list. In addition, do not configure RAP to operate on those channels.

## Good Signal-to-Noise Ratios

For European installations, the minimum recommendation is increased to 20 dB of signal-to-noise ratio (SNR). The extra dBs are used to mitigate the effects of radar interference with packet reception, which is not observed in non-DFS environments.

## Access Point Placement

Collocated mesh access points should have a minimum of 10 feet (3.048 meters) of vertical separation or 100 (30.48 meters) feet of horizontal separation.

## Check Packet Error Rate

Mesh access points that have an high error rate, greater than 1 percent, should have mitigation applied to them, by changing the channels for noise and interference, adding additional mesh access points in the transmission path, moving the mesh access points to different sectors, or adding additional mesh access points.

# Bridge Group Name Misconfiguration

A mesh access point can be wrongly provisioned with a *bridgegroupname* and placed in a group other than it was intended. Depending on the network design, this mesh access point might or might not be able to reach out and find its correct sector or tree. If it cannot reach a compatible sector, the mesh access point can become stranded.

To recover a stranded mesh access point, the concept of default *bridgegroupname* has been introduced in the software. When a mesh access point is unable to connect to any other mesh access point with its configured *bridgegroupname*, it attempts to connect with the *bridgegroupname* of *default*.

The algorithm of detecting this strand condition and recovery is as follows:

- 1 Passively scans and finds all neighbor nodes regardless of their *bridgegroupname*.
- 2 The mesh access point attempts to connect to the neighbors heard with *my own bridgegroupname* using AWPP.
- 3 If Step 2 fails, attempts to connect with default *bridgegroupname* using AWPP.
- 4 For each failed attempt in Step 3, it adds the neighbor to an exclusion list and attempts to connect the next best neighbor.

- 5 If the AP fails to connect with all neighbors in Step 4, it reboots the mesh access point.
- 6 If connected with a *default* bridgegroupname for 15 minutes, the mesh access point goes into a scan state.

When an mesh access point is able to connect with the default bridgegroupname, the parent node reports the mesh access point as a default child/node/neighbor entry on the controller, so that a network administrator is Cisco Prime Infrastructure. Such a mesh access point behaves as a normal (nonmesh) access point and accepts any client, other mesh nodes as its children, and it passes any data traffic through.

**Note**

---

Do not confuse an unassigned BGN (null value) with DEFAULT, which is a mode that the access point uses to connect when it cannot find its own BGN.

---

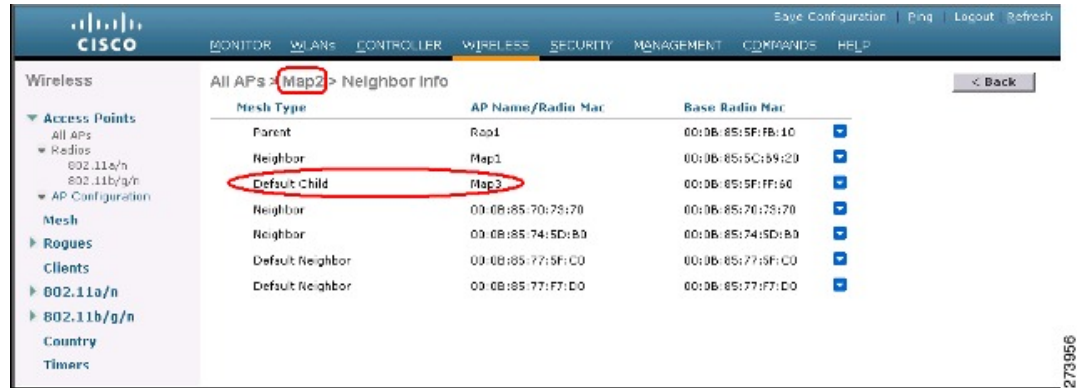
To check the current state of a mesh access point's BGN, enter the following command:

```
(Cisco Controller)> show mesh path Map3:5f:ff:60
00:0B:85:5F:FA:60 state UPDATED NEIGH PARENT DEFAULT (106B), snrUp 48, snrDown 48, linkSnr
49
00:0B:85:5F:FB:10 state UPDATED NEIGH PARENT BEACON (86B) snrUp 72, snrDown 63, linkSrn 57
00:0B:85:5F:FA:60 is RAP
```

To check the current state of a mesh access point's BGN, check the neighbor information for the mesh access point (GUI) as follows:

Choose **Wireless > All APs > AP Name > Neighbor info** .

**Figure 86: Neighbor Information for a Child**



**Figure 87: Neighbor Information for a Parent**



## Misconfiguration of the Mesh Access Point IP Address

Although most Layer 3 networks are deployed using DHCP IP address management, some network administrators might prefer the manual IP address management and allocating IP addresses statically to each mesh node. Manual mesh access point IP address management can be a nightmare for large networks, but it might make sense in small to medium size networks (such as 10 to 100 mesh nodes) because the number of mesh nodes are relatively small compared to client hosts.

Statically configuring the IP address on a mesh node has the possibility of putting a MAP on a wrong network, such as a subnet or VLAN. This mistake could prevent a mesh access point from successfully resolving the IP gateway and failing to discover a WLAN controller. In such a scenario, the mesh access point falls back to its DHCP mechanism and automatically attempts to find a DHCP server and obtains an IP address from it. This fallback mechanism prevents a mesh node from being potentially stranded from a wrongly configured static IP address and allows it to obtain a correct address from a DHCP server on the network.

When you are manually allocating IP addresses, we recommend that you make IP addressing changes from the furthest mesh access point child first and then work your way back to the RAP. This recommendation also

applies if you relocate equipment. For example, if you uninstall a mesh access point and redeploy it in another physical location of the mesh network that has a different addressed subnet.

Another option is to take a controller in Layer 2 mode with a RAP to the location with the misconfigured MAP. Set the bridge group name on the RAP to match the MAP that needs the configuration change. Add the MAP's MAC address to the controller. When the misconfigured MAP comes up in the mesh access point summary detail, configure it with an IP address.

## Misconfiguration of DHCP

Despite the DHCP fallback mechanism, there is still a possibility that a mesh access point can become stranded, if any of the following conditions exist:

- There is no DHCP server on the network.
- There is a DHCP server on the network, but it does not offer an IP address to the AP, or if it gives a wrong IP address to the AP (for example, on a wrong VLAN or subnet).

These conditions can strand a mesh access point that is configured with or without a wrong static IP address or with DHCP. Therefore, you must ensure that when a mesh access point is unable to connect after exhausting all DHCP discovery attempts or DHCP retry counts or IP gateway resolution retry counts, it attempts to find a controller in Layer 2 mode. In other words, a mesh access point attempts to discover a controller in Layer 3 mode first and in this mode, attempts with both static IP (if configured) or DHCP (if possible). The AP then attempts to discover a controller in Layer 2 mode. After finishing a number of Layer 3 and Layer 2 mode attempts, the mesh access point changes its parent node and re-attempts DHCP discovery. Additionally, the software exclusion-lists notes the parent node through which it was unable to obtain the correct IP address.

## Identifying the Node Exclusion Algorithm

Depending on the mesh network design, a node might find another node “best” according to its routing metric (even recursively true), yet it is unable to provide the node with a connection to the correct controller or correct network. It is the typical honeypot access point scenario caused by either misplacement, provisioning, design of the network, or by the dynamic nature of an RF environment exhibiting conditions that optimize the AWPP routing metric for a particular link in a persistent or transient manner. Such conditions are generally difficult to recover from in most networks and could blackhole or sinkhole a node completely, taking it out from the network. Possible symptoms include, but are not limited to the following:

- A node connects to the honeypot but cannot resolve the IP gateway when configured with the static IP address, or cannot obtain the correct IP address from the DHCP server, or cannot connect to a WLAN controller.
- A node ping-pongs between a few honeypots or circles between many honeypots (in worst-case scenarios).

Cisco mesh software resolves this difficult scenario by using a sophisticated node exclusion-listing algorithm. This node exclusion-listing algorithm uses an exponential backoff and advance technique much like the TCP sliding window or 802.11 MAC.

The basic idea relies on the following five steps:

- 1 Honeypot detection—The honeypots are first detected via the following steps:

A parent node is set by the AWPP module by:



- A static IP attempt in CAPWAP module.
  - A DHCP attempt in the DHCP module.
  - A CAPWAP attempt to find and connect to a controller fails.
- 2 Honeypot conviction—When a honeypot is detected, it is placed in a exclusion-list database with its conviction period to remain on the list. The default is 32 minutes. Other nodes are then attempted as parents in the following order, falling back to the next, upon failing the current mechanism:
    - On the same channel.
    - Across different channels (first with its own bridgegroupname and then with default).
    - Another cycle, by clearing conviction of all current exclusion-list entries.
    - Rebooting the AP.
  - 3 Nonhoneypot credit—It is often possible that a node is not really a honeypot, but appears to be due to some transient back-end condition, such as the following:
    - The DHCP server is either not up-and-running yet, has failed temporarily, or requires a reboot.
    - The WLAN controller is either not up-and-running yet, has failed temporarily, or requires a reboot.
    - The Ethernet cable on the RAP was accidentally disconnected.

Such nonhoneypots must be credited properly from their serving times so that a node can come back to them as soon as possible.
  - 4 Honeypot expiration—Upon expiration, an exclusion-list node must be removed from the exclusion-list database and return to a normal state for future consideration by AWPP.
  - 5 Honeypot reporting—Honeypots are reported to the controller via an LWAPP mesh neighbor message to the controller, which shows these on the Bridging Information page. A message is also displayed the first-time an exclusion-listed neighbor is seen. In a subsequent software release, an SNMP trap is generated on the controller for this condition so that Cisco Prime Infrastructure can record the occurrence.

**Figure 88: Excluded Neighbor**

All APs > sjc10-p1012-map1:62:40:d0 > Bridging Details [< Back](#)

Bridging Details		Bridging Links	
AP Role	MeshAP	<b>Mesh Type</b>	<b>AP Name/Radio M</b>
Bridge Group Name	betamesh	Parent	sjc14-41a-rap3-5e:9
Backhaul Interface	802.11a	<b>Excluded Neighbor</b>	00:0B:85:53:4B:3D
Switch Physical Port	29	Neighbor	00:0B:85:5C:B8:A0
Routing State	Maintenance	Neighbor	00:0B:85:5C:B9:80
Malformed Neighbor Packets	0	Neighbor	00:0B:85:5F:FA:50
Poor Neighbor SNR reporting	1	Neighbor	00:0B:85:5F:FE:E0
Blacklisted Packets	212	Neighbor	00:0B:85:5F:FF:40
Insufficient Memory reporting	0	Neighbor	00:0B:85:5F:FF:E0

Because many nodes might be attempting to join or rejoin the network after an expected or unexpected event, a hold-off time of 16 minutes is implemented, which means that no nodes are exclusion-listed during this period of time after system initialization.

This exponential backoff and advance algorithm is unique and has the following properties:

- It allows a node to correctly identify the parent nodes whether it is a true honeypot or is just experiencing temporary outage conditions.
- It credits the good parent nodes according to the time it has enabled a node to stay connected with the network. The crediting requires less and less time to bring the exclusion-list conviction period to be very low for real transient conditions and not so low for transient to moderate outages.
- It has a built-in hysteresis for encountering the initial condition issue where many nodes try to discover each other only to find that those nodes are not really meant to be in the same network.
- It has a built-in memory for nodes that can appear as neighbors sporadically so they are not accidentally considered as parents if they were, or are supposed to be, on the exclusion-list database.

The node exclusion-listing algorithm guards the mesh network against serious stranding. It integrates into AWPP in such a way that a node can quickly reconverge and find the correct network.

## Throughput Analysis

Throughput depends on packet error rate and hop count.

Capacity and throughput are orthogonal concepts. Throughput is one user's experience at node N and the total area capacity is calculated over the entire sector of N-nodes and is based on the number of ingress and egress RAP, assuming separate noninterfering channels.

For example, 4 RAPs at 10 Mbps each deliver 40 Mbps total capacity. So, one user at 2 hops out, logically under each RAP, could get 5 Mbps each of TPUT, but consume 40 Mbps of the backhaul capacity.

With the Cisco Mesh solution, the per-hop latency is less than 10 msec, and the typical latency numbers per hop range from 1 to 3 msec. Overall jitter is also less than 3 msec.

Throughput depends on the type of traffic being passed through the network: User Datagram Protocol (UDP) or Transmission Control Protocol (TCP). UDP sends a packet over Ethernet with a source and destination address and a UDP protocol header. It does not expect an acknowledgement (ACK). There is no assurance that the packet is delivered at the application layer.

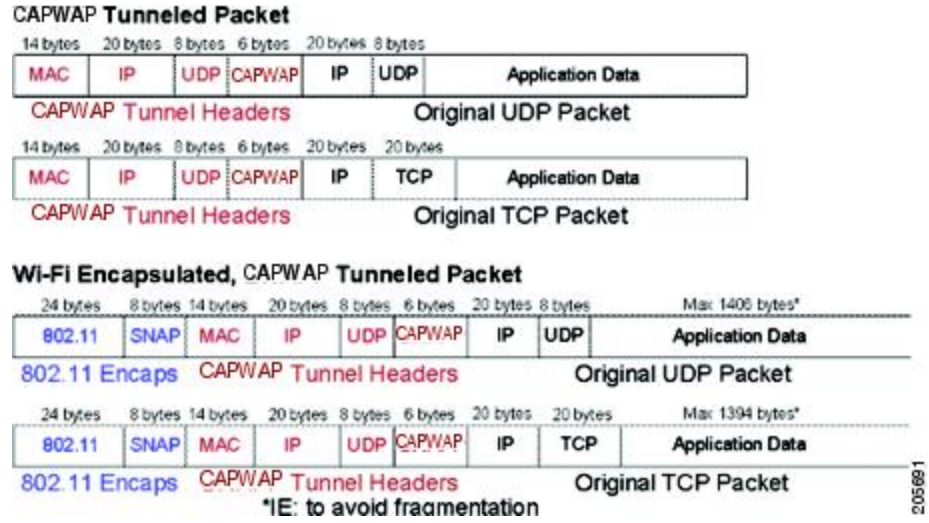
TCP is similar to UDP but it is a reliable packet delivery mechanism. There are packet acknowledgments and a sliding window technique is used to allow the sender to transmit multiple packets before waiting for an ACK. There is a maximum amount of data the client transmits (called a TCP socket buffer window) before it stops sending data. Sequence numbers track packets sent and ensure that they arrive in the correct order. TCP uses cumulative ACKs and the receiver reports how much of the current stream has been received. An ACK might cover any number of packets, up to the TCP window size.

TCP uses slow start and multiplicative decrease to respond to network congestion or packet loss. When a packet is lost, the TCP window is cut in half and the back-off retransmission timer is increased exponentially. Wireless is subject to packet loss due to interference issues and TCP reacts to this packet loss. A slow start recovery algorithm is also used to avoid swamping a connection when recovering from packet loss. The effect of these algorithms in a lossy network environment is to lessen the overall throughput of a traffic stream.

By default, the maximum segment size (MSS) of TCP is 1460 bytes, which results in a 1500-byte IP datagram. TCP fragments any data packet that is larger than 1460 bytes, which can cause at least a 30-percent throughput drop. In addition, the controller encapsulates IP datagrams in the 48-byte CAPWAP tunnel header as shown

in [Figure 89: CAPWAP Tunneled Packets](#), on page 231. Any data packet that is longer than 1394 bytes is also fragmented by the controller, which results in up to a 15-percent throughput decrease.

**Figure 89: CAPWAP Tunneled Packets**







## CHAPTER 8

# Managing Mesh Access Points with Cisco Prime Infrastructure

---

This chapter describes how to manage mesh access points with Cisco Prime Infrastructure.

To configure and monitor mesh networks from Cisco Prime Infrastructure, you must first import campus and outdoor maps into the Prime Infrastructure and add buildings. Thereafter, you can add mesh access points to the map and configure and monitor mesh access points from the Prime Infrastructure.

This chapter contains the following sections:

- [Adding Campus Maps, Outdoor Areas, and Buildings with Cisco Prime Infrastructure, page 233](#)
- [Adding Mesh Access Points to Maps with Cisco Prime Infrastructure, page 236](#)
- [Monitoring Mesh Access Points Using Google Earth, page 237](#)
- [Adding Indoor Mesh Access Points to Cisco Prime Infrastructure, page 241](#)
- [Managing Mesh Access Points with Cisco Prime Infrastructure, page 242](#)
- [Monitoring Workgroup Bridges, page 255](#)
- [Viewing AP Last Reboot Reason, page 262](#)

## Adding Campus Maps, Outdoor Areas, and Buildings with Cisco Prime Infrastructure

For mesh networks, maps and items on those maps (buildings and mesh access points) are added to Cisco Prime Infrastructure in the following order:

- 
- Step 1** Add a campus map.
  - Step 2** Add an outdoor area map.
  - Step 3** Add buildings.
  - Step 4** Add mesh access points.

Detailed steps for adding these maps and components are noted below.

---

## Adding Campus Maps

To add a single campus map to the Cisco Prime Infrastructure database, follow these steps:

- 
- Step 1** Save the map in .PNG, .JPG, .JPEG, or .GIF format.  
**Note** The map can be any size because the Prime Infrastructure automatically resizes the map to fit its working areas.
- Step 2** Browse to and import the map from anywhere in your file system.
- Step 3** Choose **Monitor > Maps** to display the Maps page.
- Step 4** From the Select a command drop-down list, choose **New Campus** and click **GO**.
- Step 5** On the Maps > New Campus page, enter the campus name and campus contact name.
- Step 6** Browse to and choose the image filename containing the map of the campus and click **Open**.
- Step 7** Select the **Maintain Aspect Ratio** check box to prevent length and width distortion when the Prime Infrastructure resizes the map.
- Step 8** Enter the horizontal and vertical span of the map in feet.  
**Note** The horizontal and vertical span should be larger than any building or floor plan to be added to the campus.
- Step 9** Click **OK** to add this campus map to the Prime Infrastructure database. The Prime Infrastructure displays the Maps page, which lists maps in the database, map types, and campus status.
- 

## Adding Outdoor Areas

To add an outdoor area to a campus map, follow these steps:



- 
- Note** You can add outdoor areas to a campus map in the Cisco Prime Infrastructure database regardless of whether you outdoor area maps are in the database.
- 

- 
- Step 1** If you want to add a map of the outdoor area to the database, save the map in .PNG, .JPG, .JPEG, or .GIF format. Then browse to and import the map from anywhere in your file system.  
**Note** You do not need a map to add an outdoor area. You can simply define the dimensions of the area to add it to the database. The map can be any size because Cisco Prime Infrastructure automatically resizes the map to fit the workspace.

- Step 2** Choose **Monitor** > **Maps** to display the Maps page.
- Step 3** Click the desired campus. Cisco Prime Infrastructure displays the Maps > Campus Name page.
- Step 4** From the Select a command drop-down list, choose **New Outdoor Area** and click **GO**.
- Step 5** On the Campus Name > New Outdoor Area page, follow these steps to create a manageable outdoor area:
- Enter the outdoor area name.
  - Enter the outdoor area contact name.
  - If desired, enter or browse to the filename of the outdoor area map.
  - Enter an approximate outdoor horizontal span and vertical span (width and depth on the map) in feet.  
**Tip** Tip You can also use **Ctrl-click** to resize the bounding area in the upper left corner of the campus map. As you change the size of the bounding area, the Horizontal Span and Vertical Span parameters of the outdoor area change to match your actions.
  - Click **Place** to put the outdoor area on the campus map. Cisco Prime Infrastructure creates an outdoor area rectangle scaled to the size of the campus map.
  - Click on the outdoor area rectangle and drag it to the desired position on the campus map.
  - Click **Save** to save this outdoor area and its campus location to the database. Cisco Prime Infrastructure saves the outdoor area name in the outdoor area rectangle on the campus map.  
**Note** A hyperlink associated with the outdoor area takes you to the corresponding Map page
- Step 6** Click **Save**.
- 

## Adding a Building to a Campus Map

You can add buildings to the Cisco Prime Infrastructure database regardless of whether you have added campus maps to the database. This section explains how to add a building to a campus map or a standalone building (one that is not part of a campus) to the Prime Infrastructure database.

To add a building to a campus map in the Prime Infrastructure database, follow these steps:

- 
- Step 1** Choose **Monitor** > **Maps** to display the Maps page.
- Step 2** Click the desired campus. Cisco Prime Infrastructure displays the Maps > Campus Name page.
- Step 3** From the Select a command drop-down list, choose **New Building** and click **Go**.
- Step 4** On the Campus Name > New Building page, follow these steps to create a virtual building in which to organize related floor plan maps:
- Enter the building name.
  - Enter the building contact name.
  - Enter the number of floors and basements.
  - Enter an approximate building horizontal span and vertical span (width and depth on the map) in feet.  
**Tip** The horizontal and vertical span should be larger than or the same size as any floors that you might add later. You can also use **Ctrl-click** to resize the bounding area in the upper left corner of the campus map. As you change the size of the bounding area, the Horizontal Span and Vertical Span parameters of the building change to match your actions.

- e) Click **Place** to put the building on the campus map. Cisco Prime Infrastructure creates a building rectangle scaled to the size of the campus map.
- f) Click on the building rectangle and drag it to the desired position on the campus map.  
**Note** After adding a new building, you can move it from one campus to another without having to recreate it.
- g) Click **Save** to save this building and its campus location to the database. Cisco Prime Infrastructure saves the building name in the building rectangle on the campus map.  
**Note** A hyperlink associated with the building takes you to the corresponding Map page.

**Step 5** Click **Save**.

---

## Adding Mesh Access Points to Maps with Cisco Prime Infrastructure

After you add the .PNG, .JPG, .JPEG, or .GIF format floor plan and outdoor area maps to the Cisco Prime Infrastructure database, you can position mesh access point icons on the maps to show where they are installed in the buildings.

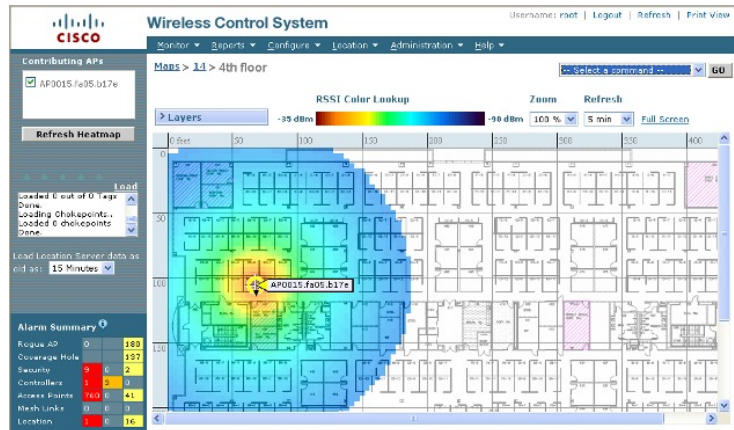
To add mesh access points to floor plan and outdoor area maps, follow these steps:

- 
- Step 1** Click the desired floor plan or outdoor area map in the Coverage Areas component of the **General** tab. Cisco Prime Infrastructure displays the associated coverage area map.
  - Step 2** From the Select a command drop-down list, choose **Add Access Points** and click **GO**.
  - Step 3** On the Add Access Points page, choose the mesh access points to add to the map.
  - Step 4** Click **OK** to add the mesh access points to the map and display the Position Access Points map.  
**Note** The mesh access point icons appear in the upper left area of the map.



- Step 5** Click and drag the icons to indicate their physical locations.
- Step 6** Click each icon and choose the antenna orientation in the sidebar.

**Figure 90: Antenna Sidebar**



The antenna angle is relative to the map’s X axis. Because the origin of the X (horizontal) and Y (vertical) axes is in the upper left corner of the map, 0 degrees points side A of the mesh access point to the right, 90 degrees points side A down, 180 degrees points side A to the left, and so on. The antenna elevation is used to move the antenna vertically, up or down, to a maximum of 90 degrees.

Make sure each mesh access point is in the correct location on the map and has the correct antenna orientation. Accurate mesh access point positioning is critical when you use the maps to find coverage holes and rogue access points.

See this location for further information about the antenna elevation and azimuth patterns:

[http://www.cisco.com/en/US/products/hw/wireless/ps469/tsd\\_products\\_support\\_series\\_home.html](http://www.cisco.com/en/US/products/hw/wireless/ps469/tsd_products_support_series_home.html)

- Step 7** Click **Save** to store the mesh access point locations and orientations. Cisco Prime Infrastructure computes the RF prediction for the coverage area. These RF predictions are popularly known as heat maps because they show the relative intensity of the RF signals on the coverage area map.

**Note** This display is only an approximation of the actual RF signal intensity because it does not take into account the attenuation of various building materials, such as drywall or metal objects. It also does not display the effects of RF signals bouncing off obstructions.

## Monitoring Mesh Access Points Using Google Earth

Cisco Prime Infrastructure supports both Google Earth Map Plus or Pro and displays, when present, mesh access points and their links.

## Launching Google Earth in Cisco Prime Infrastructure

Cisco Prime Infrastructure supports both Google Earth Map Plus or Pro and displays, when present, mesh access points and their links.

To launch Google Earth maps, follow these steps:

- Step 1** Launch Google Earth plus or pro and add a new folder.
- Step 2** Create a mesh access points placemark on Google Earth plus or pro.  
**Note** You must use the exact name of the mesh access point when creating the placement mark to ensure Prime Infrastructure can recognize these mesh access points.
- Step 3** Place the mesh access point placemarks in the new folder. Save the folder as a .KML file.
- Step 4** In the Prime Infrastructure, choose **Monitor > Google Earth Maps**. Select Import Google KML from the Select a command drop-down list.
- Step 5** Import the new Google KML folder. It displays in the folder name summary.

**Figure 91: Importing New Folder into Google Earth**



- Step 6** Click the launch icon next to the new folder to launch the Google Earth map from the Prime Infrastructure.

## Viewing Google Earth Maps

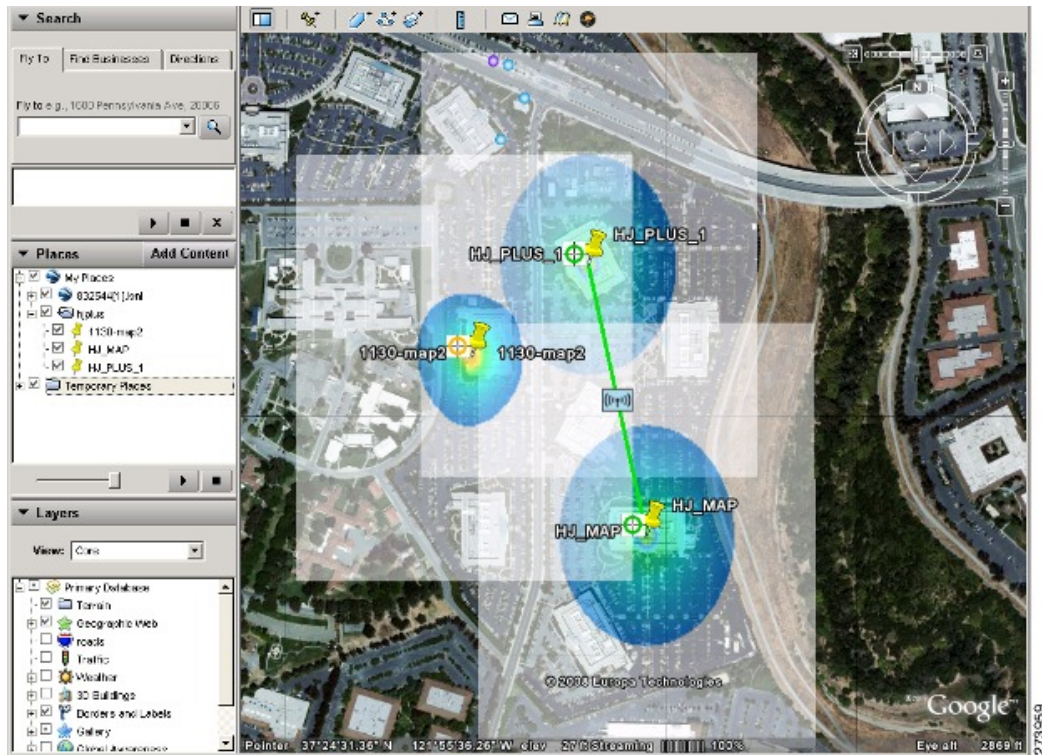
You can view campus maps, mesh access point and link information using Google maps.

To view Google Earth maps, follow these steps:

- Step 1** Log on to Cisco Prime Infrastructure.
- Step 2** Choose **Monitor > Google Earth Maps**. The Google Earth Maps page displays all folders and the number of mesh access points included within each folder.
- Step 3** Click **Launch** for the map you want to view. Google Earth opens in a separate window and displays the location and its mesh access points.

**Note** To use this feature, you must have Google Earth installed on your computer and configured to auto-launch when data is sent from the server. You can download Google Earth from Google's website.

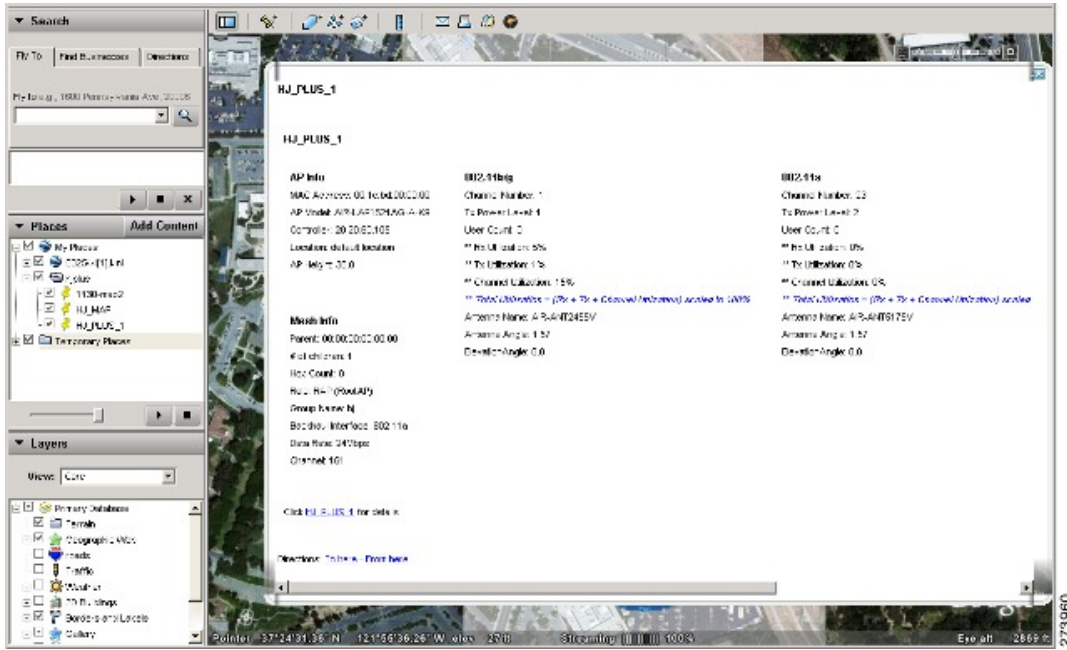
**Figure 92: Google Earth Map Page**



**Step 4** Click **Launch** for the map you want to view. Google Earth opens in a separate window and displays the location and its mesh access points.

**Note** To use this feature, you must have Google Earth installed on your computer and configured to auto-launch when data is sent from the server. You can download Google Earth from Google’s website.

**Figure 93: Google Earth Map With Mesh Access Point Details**



**Figure 94: Google Earth Map With Mesh Link Details**





To view details for a Google Earth Map folder, follow these steps:

**Step 5** From the Google Earth Map page, click the folder name to open the details page for this folder. The Google Earth Details page provides the mesh access point names and MAC or IP addresses.

**Note** To delete a mesh access point, select the applicable check box and click **Delete**. To delete the entire folder, select the check box next to Folder Name and click **Delete**. Deleting a folder also deletes all subfolders and mesh access points inside the folder.

**Step 6** Click **Cancel** to close the details page.

## Adding Indoor Mesh Access Points to Cisco Prime Infrastructure

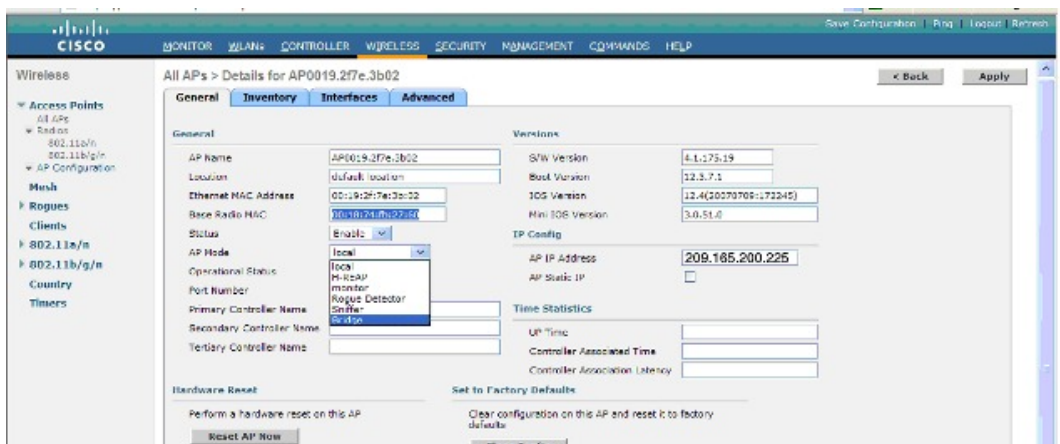
You have a choice of ordering indoor access points directly into the bridge mode, so that these access points can be used directly as mesh access points. If you have these access points in a local mode (nonmesh), then you have to connect these access points to the controller and change the radio role to the bridge mode (mesh). This task can become cumbersome particularly if the volume of the access points being deployed is large and if the access points are already deployed in the local mode for a traditional nonmesh wireless coverage.

For local mode indoor access points prior to a mesh installation, you must first connect all indoor mesh access points to the controller and change the mode to *bridge* mode.

To do so, connect all the indoor access points to the Layer 3 network on the same subnet as the Management IP address. Add the MAC address of the indoor mesh access points into the MAC filter list on the controller. All indoor access points will then join the controller in local mode.

You can then change local mode to bridge mode in the controller for every indoor access point.

**Figure 95: All APs > AP Details Controller Page**



After changing the indoor access points to bridge mode on the controller, add these indoor mesh access points into the Prime Infrastructure.

You cannot initially configure indoor mesh access points into bridge mode from the Prime Infrastructure.

---

## Managing Mesh Access Points with Cisco Prime Infrastructure

Cisco Prime Infrastructure is a complete platform for enterprise-wide WLAN systems management. It provides a wide range of tools for visualizing and controlling the mesh, including histograms of signal-to-noise ratio, mesh detail information, mesh access point neighbor and link information, seven-day temporal link information, and tools to identify and avoid RF interference.

This section addresses the following Prime Infrastructure monitoring capabilities:

- [Monitoring Mesh Networks Using Maps](#)
- [Monitoring Mesh Health](#)
- [Viewing Mesh Statistics for a Mesh Access Point](#)
- [Viewing the Mesh Network Hierarchy](#)
- [Using Mesh Filters to Modify Map Display of Maps and Mesh Links](#)

## Monitoring Mesh Networks Using Maps

You can access and view details for the following elements from a mesh network map in the Cisco Prime Infrastructure.:

- Mesh Link Statistics
- Mesh Access Points
- Mesh Access Point Neighbors

Details on how this information is accessed and the information displayed for each of these items is detailed in the following sections.

### Monitoring Mesh Link Statistics Using Maps

You can view the SNR for a specific mesh network link, view the number of packets transmitted and received on that link, and initiate a link test from the Monitor > Maps display.

To view details on a specific mesh link between two mesh access points or a mesh access point and a root access point, follow these steps:

- 
- Step 1** In Cisco Prime Infrastructure, choose **Monitor > Maps**.
  - Step 2** Click the **Map Name** that corresponds to the outdoor area, campus, building, or floor you want to monitor.
  - Step 3** Move the cursor over the link arrow for the target link. A Mesh Link page appears.

**Note** The AP Mesh Info check box under the Layers drop-down list must be selected for links to appear on the map.

**Step 4** Click either **Link Test, Child to Parent** or **Link Test, Parent to Child**. After the link test is complete, a results page appears.

**Note** A link test runs for 30 seconds.

**Note** You cannot run link tests for both links (child-to-parent and parent-to-child) at the same time.

**Step 5** To view a graphical representation of SNR statistics over a period of time, click the arrow on the link. A page with multiple SNR graphs appears.

---

The following graphs are displayed for the link:

- SNR Up—Plots the RSSI values of the neighbor from the perspective of the mesh access point.
- SNR Down—Plots the RSSI values that the neighbor reports to the mesh access point.
- Link SNR—Plots a weighed and filtered measurement based on the SNR Up value.
- The Adjusted Link Metric —Plots the value used to determine the least cost path to the root mesh access point. This value is the ease to get to the rooftop access point and accounts for the number of hops. The lower the ease value, the less likely the path is used.
- The Unadjusted Link Metric —Plots the least cost path to get to the root access point unadjusted by the number of hops. The higher the value for the unadjusted link indicates the better the path.

## Monitoring Mesh Access Points Using Maps

You can view the following summary information for a mesh access point from a mesh network map:

- Parent
- Number of children
- Hop count
- Role
- Group name
- Backhaul interface
- Data Rate
- Channel



---

**Note** This information is in addition to the information shown for all mesh access points (MAC address, mesh access point model, controller IP address, location, height of mesh access point, mesh access point up time, and CAPWAP up time).

---

To view summary and detailed configuration information for a mesh access point from a mesh network map, follow these steps:

- 
- Step 1** On the GUI of Cisco Prime Infrastructure, choose **Monitor > Maps**.
- Step 2** Click the **Map Name** that corresponds to the outdoor area, campus, building, or floor location of the mesh access point you want to monitor.
- Step 3** To view summary configuration information for a mesh access point, move the cursor over the mesh access point that you want to monitor. A page with configuration information for the selected mesh access point appears.
- Step 4** To view detailed configuration information for a mesh access point, click the arrow portion of the mesh access point label. The configuration details for the mesh access point appears.
- Note** If the mesh access point has an IP address, a Run Ping Test link is also visible at the bottom of the mesh access point panel.
- Step 5** On the Access Point configuration page, follow these steps to view configuration details for the mesh access point:
- Choose the **General** tab to view the overall configuration of the mesh access point such as AP name, MAC address, AP Up time, associated controllers (registered and primary) operational status, and software version.
 

**Note** The software version for mesh access points is appended the letter *m* and the word *mesh* in parentheses.
  - Choose the **Interface** tab to view configuration details for the interfaces supported on the mesh access point. Interface options are radio and Ethernet.
  - Choose the **Mesh Links** tab to view parent and neighbors' details (name, MAC address, packet error rate, and link details) for the mesh access point. You can also initiate link tests from this panel.
  - Choose the **Mesh Statistics** tab to view details on the bridging, queue, and security statistics for the mesh access point. For more details on mesh statistics, see the [Viewing Mesh Statistics for a Mesh Access Point](#) section.
- 

## Monitoring Mesh Access Point Neighbors Using Maps

To view details on neighbors of a mesh access point from a mesh network map, follow these steps:

- 
- Step 1** Choose **Monitor > Maps**.
- Step 2** Click the **Map Name** that corresponds to the outdoor area, campus, building, or floor you want to monitor.
- Step 3** To view detailed information on mesh links for a mesh access point, click the arrow portion of the access point label. The Access Points screen appears.
- Step 4** Click the **Mesh Links** tab.
- Note** You can also mesh link details for neighbors of a selected mesh access point by clicking on the View Mesh Neighbors link on the mesh access point configuration summary panel that displays when you mouse over a mesh access point on a map.
- Note** Signal-to-noise ratio (SNR) only appears on the View Mesh Neighbors panel.
- Note** In addition to listing the current and past neighbors in the panel that displays, labels are added to the mesh access points map icons to identify the selected mesh access point, the neighbor mesh access point, and the child mesh access point. Select the clear link of the selected mesh access point to remove the relationship labels from the map.



**Note** The drop-down lists at the top of the mesh neighbors page indicate the resolution of the map (100%) displayed and how often the information displayed is updated (5 minutes). You can modify these default values.

## Monitoring Mesh Health

Mesh Health monitors the overall health of outdoor and indoor mesh access points, except as noted. Tracking this environmental information is particularly critical for mesh access points that are deployed outdoors. The following factors are monitored:

- Temperature—Displays the internal temperature of the mesh access point in Fahrenheit and Celsius (AP1500s only).
- Heater status—Displays the heater as on or off (AP1500s only).
- AP Up time—Displays how long the mesh access point has been active to receive and transmit.
- CAPWAP Join Taken Time—Displays how long it took to establish the CAPWAP connection.
- CAPWAP Up Time—Displays how long the CAPWAP connection has been active.

Mesh Health information is displayed in the General Properties panel for mesh access points.

To view the mesh health details for a specific mesh access point, follow these steps:

- Step 1** Choose **Monitor > Access Points**. A listing of access points appears.
- Note** You can also use the New Search button to display the mesh access point summary shown below. With the New Search option, you can further define the criteria of the access points that display. Search criteria include AP Type, AP Mode, Radio Type, and 802.11n Support.
- Step 2** Click the **AP Name** link to display details for that mesh access point. The General Properties panel for that mesh access point appears.



**Note** You can also access the General properties panel for a mesh access point from a Cisco Prime Infrastructure map page. To display the panel, click the arrow portion of the mesh access point label. A tabbed panel appears and displays the General properties panel for the selected access point.

To add, remove, or reorder columns in the table, click the **Edit View** link. [Table 42: Monitor Access Points Additional Search Results Parameters](#), on page 245 displays optional access point parameters available from the Edit View page.

**Table 42: Monitor Access Points Additional Search Results Parameters**

Column	Options
AP Type	Indicates the type of access point (unified or autonomous).

Column	Options
Antenna Azim. Angle	Indicates the horizontal angle of the antenna.
Antenna Diversity	Indicates if antenna diversity is enabled or disabled. Antenna diversity refers to the access point sampling the radio signal from two integrated antenna ports in order to choose the preferred antenna.
Antenna Elev. Angle	Indicates the elevation angle of the antenna.
Antenna Gain	Indicates the peak gain of the dBi of the antenna for directional antennas and the average gain in dBi for omnidirectional antennas connected to the wireless network adapter. The gain is in multiples of 0.5 dBm. An integer value 4 means 4 x 0.5 = 2 dBm of gain.
Antenna Mode	Indicates the antenna mode such as omni, directional, or nonapplicable.
Antenna Name	Indicates the antenna name or type.
Antenna Type	Indicates whether the antenna is internal or external.
Audit Status	Indicates one of the following audit statuses: <ul style="list-style-type: none"> <li>• Mismatch—Config differences were found between Cisco Prime Infrastructure and controller during the last audit.</li> <li>• Identical—No config differences were found during the last audit.</li> <li>• Not Available—Audit status is unavailable.</li> </ul>
Bridge Group Name	Indicates the name of the bridge group used to group the access points, if applicable.
CDP Neighbors	Indicates all directly connected Cisco devices.
Channel Control	Indicates whether the channel control is automatic or custom.
Channel Number	Indicates the channel on which the Cisco radio is broadcasting.
Controller Port	Indicates the number of controller ports.
Node Hops	Indicates the number of hops between access point.

Column	Options
POE Status	<p>Indicates the Power-over-Ethernet status of the access point. The possible values are as follows:</p> <ul style="list-style-type: none"> <li>• Low—The access point draws low power from the Ethernet.</li> <li>• Lower than 15.4 volts—The access point draws lower than ?15.4 V from the Ethernet.</li> <li>• Lower than 16.8 volts—The access point draws lower than ?16.8 V from the Ethernet.</li> <li>• Normal—The power is high enough for the operation of the access point.</li> <li>• Not Applicable—The power source is not from the Ethernet.</li> </ul>
Primary Controller	Indicates the name of the primary controller for this access point.
Radio MAC	Indicates the radio's MAC address.
Reg. Domain Supported	Indicates whether or not the regulatory domain is supported.
Serial Number	Indicates the access point's serial number.
Slot	Indicates the slot number.
Tx Power Control	Indicates whether the transmission power control is automatic or custom.
Tx Power Level	Indicates the transmission power level.
Up Time	Indicates how long the access point has been up in days, hours, minutes, and seconds.
WLAN Override Names	Indicates the WLAN override profile names.
WLAN Override	Indicates whether WLAN Override is enabled or disabled. Each access point is limited to 16 WLAN profiles. Each access point broadcasts all WLAN profiles unless the WLAN override feature is enabled. The WLAN override feature allows you to disable any of the 16 WLAN profiles per access point.

## Viewing Mesh Statistics for a Mesh Access Point

Mesh Statistics are reported when a child mesh access point authenticates or associates with a parent mesh access point.

Security entries are removed and no longer displayed when the child mesh access point disassociates from the controller.

The following mesh security statistics are displayed for mesh access points:

- Bridging
- Queue
- Security

To view the mesh statistics for a specific mesh access point, follow these steps:

- Step 1** Choose **Monitor > Access Points**. A listing of access points appears.
- Note** You can also use the New Search button to display the access point summary. With the New Search option, you can further define the criteria of the access points that display. Search criteria include AP Name, IP address, MAC address, Controller IP or Name, Radio type, and Outdoor area.
- Step 2** Click the **AP Name** link of the target mesh access point.  
A tabbed panel appears and displays the General Properties page for the selected mesh access point.
- Step 3** Click the **Mesh Statistics** tab. A three-tabbed Mesh Statistics panel appears.
- Note** The Mesh Statistics tab and its subordinate tabs (Bridging, Queue and Security) only appear for mesh access points. The Mesh Link Alarms and Mesh Link Events links are accessible from each of the three tabbed panels.
- Note** You can also access the Mesh Securities panel for a mesh access point from a Cisco Prime Infrastructure map. To display the panel, click the arrow portion of the mesh access point label.
- Summaries of the Bridging, Queue and Security Statistics and their definitions are provided in the following tables.

**Table 43: Bridging Mesh Statistics**

Parameter	Description
Role	The role of the mesh access point. Options are mesh access points (MAPs) and root access points (RAPs).
Bridge Group Name (BGN)	The name of the bridge group to which the MAP or RAP is a member. Assigning membership in a BGN is recommended. If one is not assigned, a MAP is by default assigned to a default BGN.
Backhaul Interface	The radio backhaul for the mesh access point.
Routing State	The state of parent selection. Values that display are seek, scan, and maint. Maint displays when parent selection is complete.
Malformed Neighbor Packets	The number of malformed packets received from the neighbor. Examples of malformed packets include malicious floods of traffic such as malformed or short DNS packets and malformed DNS replies.
Poor Neighbor SNR	The number of times the signal-to-noise ratio falls below 12 dB on the backhaul link.

Parameter	Description
Excluded Packets	The number of packets received from excluded neighbor mesh access points.
Insufficient Memory	The number of insufficient memory conditions.
RX Neighbor Requests	The number of broadcast and unicast requests received from the neighbor mesh access points.
RX Neighbor Responses	The number of responses received from the neighbor mesh access points.
TX Neighbor Requests	The number of unicast and broadcast requests sent to the neighbor mesh access points.
TX Neighbor Responses	The number of responses sent to the neighbor mesh access points.
Parent Changes	The number of times a mesh access point (child) moves to another parent.
Neighbor Timeouts	The number of neighbor timeouts.
Node Hops	The number of hops between the MAP and the RAP. Click the value link to display a subpanel that enables you to configure details of what is reported, how often the node hop value is updated, and view a graphical representation of the report.

**Table 44: Queue Mesh Statistics**

Parameter	Description
Silver Queue	The average and peak number of packets waiting in the silver (best effort) queue during the defined statistics time interval. Packets dropped and queue size are also summarized.
Gold Queue	The average and peak number of packets waiting in the gold (video) queue during the defined statistics time interval. Packets dropped and queue size are also summarized.
Platinum Queue	The average and peak number of packets waiting in the platinum (voice) queue during the defined statistics time interval. Packets dropped and queue size are also summarized.

Parameter	Description
Bronze Queue	The average and peak number of packets waiting in the bronze (background) queue during the defined statistics time interval. Packets dropped and queue size are also summarized.
Management Queue	The average and peak number of packets waiting in the management queue during the defined statistics time interval. Packets dropped and queue size are also summarized.

**Table 45: Security Mesh Statistics**

Parameter	Description
Association Request Failures	Summarizes the total number of association request failures that occur between the selected mesh access point and its parent.
Association Request Success	Summarizes the total number of successful association requests that occur between the selected mesh access point and its parent.
Association Request Timeouts	Summarizes the total number of association request timeouts that occur between the selected mesh access point and its parent.
Authentication Request Failures	Summarizes the total number of failed authentication requests that occur between the selected mesh access point and its parent.
Authentication Request Success	Summarizes the total number of successful authentication requests between the selected mesh access point and its parent mesh node.
Authentication Request Timeouts	Summarizes the total number of authentication request timeouts that occur between the selected mesh access point and its parent.
Invalid Association Request	Summarizes the total number of invalid association requests received by the parent mesh access point from the selected child mesh access point. This state might occur when the selected child is a valid neighbor but is not in a state that allows association.

Parameter	Description
Invalid Reassociation Request	Summarizes the total number of invalid reassociation requests received by the parent mesh access point from a child. This state might occur when a child is a valid neighbor but is not in a proper state for reassociation.
Invalid Reauthentication Request	Summarizes the total number of invalid reauthentication requests received by the parent mesh access point from a child. This state might occur when a child is a valid neighbor but is not in a proper state for reauthentication.
Packets Received	Summarizes the total number of packets received during security negotiations by the selected mesh access point.
Packets Transmitted	Summarizes the total number of packets transmitted during security negotiations by the selected mesh access point.
Reassociation Request Failures	Summarizes the total number of failed reassociation requests between the selected mesh access point and its parent.
Reassociation Request Success	Summarizes the total number of successful reassociation requests between the selected mesh access point and its parent.
Reassociation Request Timeouts	Summarizes the total number of reassociation request timeouts between the selected mesh access point and its parent.
Reauthentication Request Failures	Summarizes the total number of failed reauthentication requests between the selected mesh access point and its parent.
Reauthentication Request Success	Summarizes the total number of successful reauthentication requests that occurred between the selected mesh access point and its parent.
Reauthentication Request Timeouts	Summarizes the total number of reauthentication request timeouts that occurred between the selected mesh access point and its parent.
Unknown Association Requests	Summarizes the total number of unknown association requests received by the parent mesh access point from its child. The unknown association requests often occur when a child is an unknown neighbor mesh access point.

Parameter	Description
Unknown Reassociation Request	Summarizes the total number of unknown reassociation requests received by the parent mesh access point from a child. This state might occur when a child mesh access point is an unknown neighbor.
Unknown Reauthentication Request	Summarizes the total number of unknown reauthentication requests received by the parent mesh access point node from its child. This state might occur when a child mesh access point is an unknown neighbor.

## Viewing the Mesh Network Hierarchy

You can view the parent-child relationship of mesh access points within a mesh network in an easily navigable display. You can also filter which mesh access points display on the Map view, by selecting only mesh access points of interest.

To view the mesh network hierarchy for a selected network, follow these steps:

- 
- Step 1** Choose **Monitor > Maps**.
- Step 2** Select the map that you want to be displayed.
- Step 3** Click the Layers arrow to expand that menu.
- Step 4** Select the **AP Mesh Info** check box if it is not already checked.
- Note** The AP Mesh Info check box can be selected only if mesh access points are present on the map. It must be checked to view the mesh hierarchy.
- Step 5** Click the AP Mesh Info arrow to display the mesh parent-child hierarchy.
- Step 6** Click the plus (+) sign next to a mesh access point to display its children.  
All subordinate mesh access points are displayed when a negative (-) sign displays next to the parent mesh access point entry.
- Step 7** Move the cursor over the colored dot next to each mesh access point child to view details on the link between it and its parent. [Table 46: Bridging Link Information, on page 253](#) summarizes the parameters that display.  
The color of the dot also provides a quick reference point of the SNR strength.
- A green dot represents a high SNR (above 25 dB).
  - An amber dot represents an acceptable SNR (20 to 25 dB).
  - A red dot represents a low SNR (below 20 dB).
  - A black dot indicates a root access point.



**Table 46: Bridging Link Information**

Parameter	Description
Information fetched on	Date and time that information was compiled.
Link SNR	Link signal-to-noise ratio (SNR).
Link Type	Hierarchical link relationship.
SNR Up	Signal-to-noise ratio for the uplink (dB).
SNR Down	Signal-to-noise ratio for the downlink (dB).
PER	Packet error rate for the link.
Tx Parent Packets	TX packets to a node while acting as a parent.
Rx Parent Packets	RX packets to a node while acting as a parent.
Time of Last Hello	Date and time of last hello.

## Using Mesh Filters to Modify Map Display of Maps and Mesh Links

In the mesh hierarchical page, you can also define mesh filters to determine which mesh access points display on the map based on hop values as well as what labels display for mesh links.

Mesh access points are filtered by the number of hops between them and their root access point.

To use mesh filtering, follow these steps:

### Step 1

To modify what label and color displays for a mesh link, do the following:

In the Mesh Parent-Child Hierarchical View, select an option from the Link Label drop-down list. Options are None, Link SNR, and Packet Error Rate.

In the Mesh Parent-Child Hierarchical View, select an option from the Link Color drop-down list to define which parameter (Link SNR or Packet Error Rate) determines the color of the mesh link on the map.

**Note** The color of the link provides a quick reference point of the SNR strength or Packet Error Rate.

**Table 47: Definition for SNR and Packet Error Rate Link Color**

Link Color	Link SNR	Packet Error Rate (PER)
Green	Represents an SNR above 25 dB (high value)	Represents a PER of one percent (1%) or lower
Amber	Represents an SNR between 20 and 25 dB (acceptable value)	Represents a PER that is less than ten percent (10%) and greater than one percent (1%)
Red	Represents an SNR below 20 dB (low value)	Represents a PER that is greater than ten percent (10%)

**Note** The Link label and color settings are reflected on the map immediately. You can display both SNR and PER values simultaneously.

**Step 2**

To modify which mesh access points display based on the number of hops between them and their parents, do the following:

In the Mesh Parent-Child Hierarchical View, click the Quick Selections drop-down list.

Select the appropriate option from the list.

**Table 48: Quick Selection Options**

Parameter	Description
Select only Root APs	Choose this setting if you want the map view to display root access points only.
Parameter	Description
Select up to 1st hops	Choose this setting if you want the map view to display 1st hops only.
Select up to 2nd hops	Choose this setting if you want the map view to display 2nd hops only.
Select up to 3rd hops	Choose this setting if you want the map view to display 3rd hops only.
Select up to 4th hops	Choose this setting if you want the map view to display 4th hops only.
Select All	Select this setting if you want the map view to display all access points.

Click Update Map View to refresh the screen and redisplay the map view with the selected options.

**Note** Map view information is retrieved from the Cisco Prime Infrastructure database and is updated every 15 minutes.

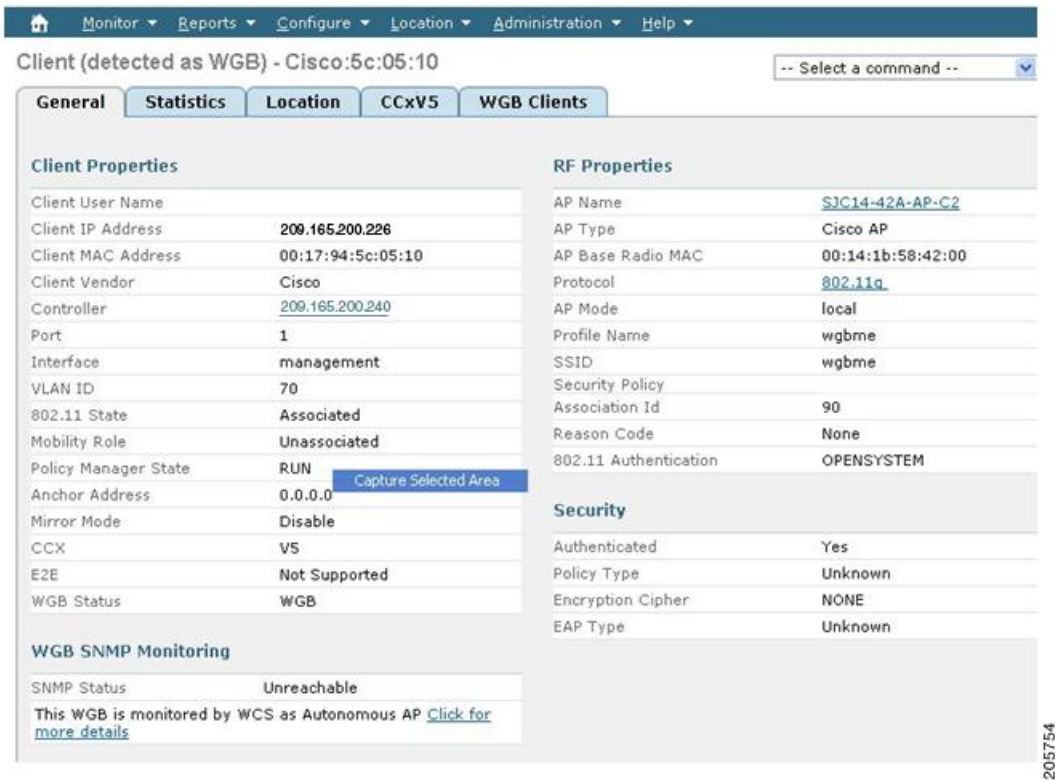
**Note** You can also select or deselect the check boxes of mesh access points in the mesh hierarchical view to modify which mesh access points are displayed. For a child access point to be visible, the parent access point to root access point must be selected.

# Monitoring Workgroup Bridges

You can monitor workgroup bridge (WGB) clients separately.

**Step 1** On the Cisco Prime Infrastructure GUI, choose **Monitor > WGBs**.

**Figure 96: Monitor > WGBs**



205754

**Step 2** Click the WGB Clients tab to see a summary of WGB clients.

**Figure 97: Monitor > WGBs > WGB Clients Panel**

## Multiple VLAN and QoS Support for WGB Wired Clients

A WGB is a small standalone unit that can provide a wireless infrastructure connection for Ethernet-enabled devices. Devices that do not have a wireless client adapter to connect to the wireless network can be connected to the WGB through the Ethernet port. The WGB associates with the root AP through the wireless interface, which means that wired clients get access to the wireless network.

This feature provides the segregation of traffic based on VLANs for different applications running on different devices connected to a switch behind a WGB. Traffic from WGB clients are sent in the right priority queue in the mesh backhaul based on DSCP/dot1p values.



### Note

You need a special autonomous image on the autonomous access points being used as a WGB for interoperability with the Unified CAPWAP infrastructure. This image will be merged with the next official autonomous release.

The WGB informs the WLC about the wired-client VLAN information in an IAPP association message. The WGB removes the 802.1Q header from the packet while sending to the WLC. The WLC sends the packet to the WGB without the 802.1Q tag and the WGB adds 802.1Q header to packets that go to the wired switch based on the destination MAC address.

The WLC treats the WGB client as a VLAN client and forwards the packet in the right VLAN interface based on the source MAC address.

You must enable the WGB unified client for multiple VLAN support on the WGB by entering the `workgroup-bridge unified-VLAN-client` command. This WGB unified client is disabled by default.

You have to configure subinterfaces on the WGB that corresponds to the VLANs on the switch ports to which the wired clients are connected.

## Workgroup Bridge Guidelines

Follow these guidelines when configuring WGBs:

- A dynamic interface should be created in the controller for each VLAN that is configured in the WGB.
- Only one WLAN (SSID) for a wireless association of the WGB to the access point infrastructure is supported. This SSID should be configured as an infrastructure SSID and should be mapped to the native VLAN. The WGB drops everything that is not in the native VLAN in the mesh infrastructure.
- We recommend that you configure the same native VLAN in the switch that connects the WLC, WGB, and in the switch behind the WGB.

All native VLAN clients on the WGB Ethernet side are part of the same VLAN in which the WGB is associated. The WGB is part of the VLAN to which the WLAN (in which the WGB has associated) is mapped.

For example, if in the WGB, the 5-GHz radio (dot11radio 1) is mapped to a native VLAN 184, and the switch behind WGB has wired clients only in VLAN 185 and 186, then you may not require the native VLAN to be identical to the native VLAN on the WGB (VLAN 184).

But, if you add one wired client in VLAN 184 and this VLAN client in the WGB belongs to a native VLAN, you must define the same native VLAN on the switch.

- Intersubnet mobility is supported with this feature for VLAN clients behind the WGB with a limitation that the dynamic interface for all VLANs of the WGB should be configured in all the controllers.
- Interoperability with a VLAN-pooling feature is not supported. When the VLAN-pooling feature is enabled, the WGB and its native VLAN clients become part of the same VLAN.
- AAA-override for WGB clients is not supported, but AAA-override for the WGB is supported.
- Only Layer 3 multicast is provided for WGB VLAN clients and there is no support for Layer 2 multicast.
- There is a 20-client limitation in WGB that includes wireless clients.
- Link testing for WGB wired clients is not supported.
- Roaming is supported for wireless and wired clients behind WGB.
- Multicast is supported for wired clients behind WGB.
- Broadcast is supported.
- Non-Cisco workgroup bridges are supported on Mesh access points.

## Configuring VLAN and QoS Support (CLI)

In the following example, VLANs 184 and 185 exist on the wired switch behind WGB. WGB's native VLAN is 184. SSID is auto-wgb mapped to native VLAN 184. Radio 1 (5 GHz) radio is used to connect to the CAPWAP infrastructure using this SSID.

```
ap#config t
ap(config)#workgroup-bridge unified-VLAN-client
ap(config)#int FastEthernet0.184
ap(config-subif)#encapsulation dot1q 184 native
ap(config-subif)#bridge-group 1
ap(config-subif)#exit
ap(config)#int FastEthernet0.185
ap(config-subif)#encapsulation dot1q 185
ap(config-subif)#bridge-group 185
ap(config-subif)#exit
ap(config)#int Dot11Radio 1.185
ap(config-subif)#encapsulation dot1q 185
ap(config-subif)#bridge-group 185
ap(config-subif)#exit
ap(config)#int Dot11Radio 1.184
ap(config-subif)#encapsulation dot1q 184 native
ap(config-subif)#bridge-group 1
ap(config-subif)#exit
ap(config)#dot11 ssid auto-wgb
ap(config-ssid)#authentication open
ap(config-ssid)#infrastructure-ssid
ap(config-ssid)#VLAN 184
ap(config-ssid)#exit
ap(config)#int Dot11Radio 1
ap(config-if)#station-role workgroup-bridge
ap(config-if)#ssid auto-wgb
ap(config-if)#exit
ap(config)#bridge irb
ap(config)#hostname WGB
```

The **bridge irb** command is used to enable integrated routing and bridging, which the Auto AP code has retained from other higher end platforms.

You have to create dynamic interfaces 184 and 185 on the WLC for the above configuration to work. The WGB updates the WLC about the wired-client VLAN information in the IAPP association message. The WLC treats the WGB client as a VLAN-client and forwards the packet in the right VLAN interface based on the source MAC address. In the upstream direction, the WGB removes the 802.1Q header from the packet and sends it to the WLC. In the downstream direction, the WLC sends the packet to the WGB without the 802.1Q tag and the WGB adds the 802.1Q header based on the destination MAC address, while forwarding the packet to the switch that connects the wired client.

## Workgroup Bridge Output

Enter the following command:

```
WGB#sh bridge
Total of 300 station blocks, 292 free
Codes: P - permanent, S - self
```

Bridge Group 1:

Address	Action	Interface	Age	RX count	TX count
0023.049a.0b12	forward	Fa0.184	0	2	0
0016.c75d.b48f	forward	Fa0.184	0	21	0
0021.91f8.e9ae	forward	Fa0.184	0	110	16
0017.59ff.47c2	forward	Vi0.184	0	23	22
0021.5504.07b5	forward	Fa0.184	0	18	6
0021.1c7b.38e0	forward	Vi0.184	0	6	0

Bridge Group 185:

0016.c75d.b48f	forward	Fa0.185	0	10	0
001e.5831.c74a	forward	Fa0.185	0	9	0

## WGB Detail on Controller

To display WGB details about the controller, enter the following command:

```
(Cisco Controller) > show wgb summary
```

```
Number of WGBs..... 2
```

MAC Address	IP Address	AP Name	Status	WLAN	Auth	Protocol	Clients
00:1d:70:97:bd:e8	209.165.200.225	c1240	Assoc	2	Yes	802.11a	2
00:1e:be:27:5f:e2	209.165.200.226	c1240	Assoc	2	Yes	802.11a	5

```
Cisco Controller) > show client summary
```

```
Number of Clients..... 7
```

MAC Address	AP Name	Status	WLAN/Guest-Lan	Auth	Protocol	Port	Wired
00:00:24:ca:a9:b4	R14	Associated	1	Yes	N/A	29	No
00:24:c4:a0:61:3a	R14	Associated	1	Yes	802.11a	29	No
00:24:c4:a0:61:f4	R14	Associated	1	Yes	802.11a	29	No
00:24:c4:a0:61:f8	R14	Associated	1	Yes	802.11a	29	No
00:24:c4:a0:62:0a	R14	Associated	1	Yes	802.11a	29	No
00:24:c4:a0:62:42	R14	Associated	1	Yes	802.11a	29	No
00:24:c4:a0:71:d2	R14	Associated	1	Yes	802.11a	29	No

```
(Cisco Controller) > show wgb detail 00:1e:be:27:5f:e2
```

```
Number of wired client(s): 5
```

MAC Address	IP Address	AP Name	Mobility	WLAN	Auth
00:16:c7:5d:b4:8f	Unknown	c1240	Local	2	No
00:21:91:f8:e9:ae	209.165.200.232	c1240	Local	2	Yes
00:21:55:04:07:b5	209.165.200.234	c1240	Local	2	Yes
00:1e:58:31:c7:4a	209.165.200.236	c1240	Local	2	Yes
00:23:04:9a:0b:12	Unknown	c1240	Local	2	No



WGB\_1#sh ip int brief

Interface	IP Address	OK?	Method	Status	Protocol
BVI1	209.165.200.225	YES	DHCP	up	up
Dot11Radio0	unassigned	YES	unset	admindown	down
Dot11Radio1	unassigned	YES	TFTP	up	up
Dot11Radio1.184	unassigned	YES	other	up	up
Dot11Radio1.185	unassigned	YES	unset	up	up
FastEthernet0	unassigned	YES	other	up	up
FastEthernet0.184	unassigned	YES	unset	up	up
FastEthernet0.185	unassigned	YES	unset	up	up
Virtual-Dot11Radio0	unassigned	YES	TFTP	up	up
Virtual-Dot11Radio0.184	unassigned	YES	unset	up	up
Virtual-Dot11Radio0.185	unassigned	YES	unset	up	up

## Troubleshooting Tips

If a WGB client does not associate with the WGB, note these tips to troubleshoot the problem:

- The native VLAN that is configured on the WGB needs to be the same VLAN on the switch to which the WGB is connected. The switch port connected to the WGB should be Trunk.
- Verify the client configuration and ensure that the client configuration is correct.
- Check the show bridge command output in the autonomous AP and confirm that the AP is reading the client MAC address in the right interface.
- Confirm that the subinterfaces that correspond to specific VLANs and different subinterfaces are mapped to the bridge group.
- WGB reads the switch port behind as a client in its MAC address table.
- If required, clear the bridge entry using the clear bridge command (remember that this command will remove all the wired and wireless clients associated with the WGB and make them associated again).
- Ensure that the WGB has not exceeded its 20-client limitation.

## Viewing AP Last Reboot Reason

Cisco Prime Infrastructure reports the reason for the most recent reboot on the general panel of the access point details page (**Monitor > Access Points > AP Name**).

Listed below is a summary of each of the possible Last Reboot Reasons that might be reported and its definition:

- none—Access point reported a reboot reason unknown to the controller
- dot11gModeChange—Change of 802.11g mode change occurred
- ipAddressSet—Set of static IP address
- ip AddressReset—Reset of static IP address
- rebootFromController—Reboot of access point initiated from the controller
- dhcpFallbackFail—Fallback to DHCP did not occur
- discoveryFail—Discovery was not sent
- noJoinResponse—Join response was not received
- denyJoin—Join attempt at the controller was denied
- noConfigResponse—Config Response was not received
- configController—Configured or master controller found
- imageUpgrade Success—Upgrade of image successful
- imageOpcodeInvalid—Invalid image data opcode
- imageChecksumInvalid—Invalid image md 5 checksum
- imageDataTimeout—Image data message timed-out
- configFileInvalid—Invalid config file
- imageDownloadError—Process error during the image download
- rebootFromConsole—Reboot command initiated from AP console
- rapOverAir—Root access point (RAP) is connected over the air
- brownout—Power failure caused reboot
- powerLow—Low power caused a reboot
- crash—Software failure caused crash
- powerHigh—Power spike caused reboot
- powerLoss—Power loss caused reboot
- powerCharge—Change in power source caused reboot
- componentFailure—Component failure caused reboot
- watchdog—Watch dog timer reset caused reboot



## INDEX

1524SB Mesh Access Point [12](#)

### A

Access Point Roles [2, 106](#)

    Defining [106](#)

AP1552C [9](#)

AP1552CU [11](#)

AP1552E [8](#)

AP1552EU [11](#)

AP1552H [10](#)

AP1552I [10](#)

### B

Backhaul Client Access [123](#)

Backup Controllers [109](#)

Base License [63](#)

Beamwidth [28](#)

### C

CAC [174](#)

    in mesh networks [174](#)

CAPWAP [41](#)

Cell Planning and Distance [75, 77](#)

    AP1520 Series [75](#)

    AP1550 Series [77](#)

Channels Supported Per Regulatory Domain [22](#)

CleanAir [94, 96, 97, 98](#)

    Access Point Deployment Recommendations [96](#)

    Advisor [97](#)

    Licensing [98](#)

    Modes of Operation [94](#)

ClientLink Technology [59, 62](#)

    Related Commands [62](#)

configuring ClientLink (CLI) [61](#)

Controller Planning [62](#)

### D

DOCSIS/EuroDOCSIS [8](#)

Dynamic Frequency Selection [26](#)

### E

EPON SFP [11](#)

### F

Federal Aviation Administration [24](#)

Federal Communications Commission [24](#)

Frequency Bands [25](#)

Fresnel Zone [65, 67](#)

### G

Google Earth Map [237](#)

Google Earth Maps [238](#)

    Viewing [238](#)

### H

Hazardous Location Certification [38](#)

### I

Indoor Mesh Access Points [4](#)

### L

LED Status [19](#)

    Monitoring [19](#)

LinkSNR Requirements [56, 57](#)

Locally Significant Certificates [188](#)

## M

Maximum Ratio Combining [36](#)

For the 1550 Series [36](#)

Maximum Ration Combining [36](#)

For the 1520 Series [36](#)

mesh [206](#)

statistics [206](#)

viewing for an access point using the GUI [206](#)

Mesh Range [52](#)

Configuring [52](#)

Monitoring Mesh Health [245](#)

Monitoring Mesh Link Statistics Using Maps [242](#)

## N

N-Connectors [29](#)

National Telecommunications and Information Administration [24](#)

## P

Polarization [28](#)

Pre-Survey Checklist [65](#)

Preferred Parent [72, 73](#)

Configuring [73](#)

Selection Criteria [72](#)

Pseudo MAC and Merging [95](#)

## R

Range Calculator [52](#)

AP1522 [52](#)

AP1552 [52](#)

## S

Slot Bias [70, 71](#)

Disabling [71](#)

Options [70](#)

## T

Terminal Doppler Weather Radar [24](#)

## U

Universal Access [50](#)

Upgrade Controller Software [104](#)

## W

Wireless Backhaul [49](#)

Wireless Backhaul Data Rate [128](#)

Wireless Bridging [50, 51](#)

Point-to-Multipoint [50](#)

Point-to-Point [51](#)

Wireless Software Compatibility Matrix [104](#)

Workgroup Bridges [255](#)

Monitoring [255](#)

WPlus License [63](#)