



Ultra Packet Core CUPS Control Plane Administration Guide, Release 21.28

First Published: 2022-09-29

Last Modified: 2024-07-31

Americas Headquarters

Cisco Systems, Inc.
170 West Tasman Drive
San Jose, CA 95134-1706
USA
<http://www.cisco.com>
Tel: 408 526-4000
800 553-NETS (6387)
Fax: 408 527-0883

THE SPECIFICATIONS AND INFORMATION REGARDING THE PRODUCTS IN THIS MANUAL ARE SUBJECT TO CHANGE WITHOUT NOTICE. ALL STATEMENTS, INFORMATION, AND RECOMMENDATIONS IN THIS MANUAL ARE BELIEVED TO BE ACCURATE BUT ARE PRESENTED WITHOUT WARRANTY OF ANY KIND, EXPRESS OR IMPLIED. USERS MUST TAKE FULL RESPONSIBILITY FOR THEIR APPLICATION OF ANY PRODUCTS.

THE SOFTWARE LICENSE AND LIMITED WARRANTY FOR THE ACCOMPANYING PRODUCT ARE SET FORTH IN THE INFORMATION PACKET THAT SHIPPED WITH THE PRODUCT AND ARE INCORPORATED HEREIN BY THIS REFERENCE. IF YOU ARE UNABLE TO LOCATE THE SOFTWARE LICENSE OR LIMITED WARRANTY, CONTACT YOUR CISCO REPRESENTATIVE FOR A COPY.

The Cisco implementation of TCP header compression is an adaptation of a program developed by the University of California, Berkeley (UCB) as part of UCB's public domain version of the UNIX operating system. All rights reserved. Copyright © 1981, Regents of the University of California.

NOTWITHSTANDING ANY OTHER WARRANTY HEREIN, ALL DOCUMENT FILES AND SOFTWARE OF THESE SUPPLIERS ARE PROVIDED "AS IS" WITH ALL FAULTS. CISCO AND THE ABOVE-NAMED SUPPLIERS DISCLAIM ALL WARRANTIES, EXPRESSED OR IMPLIED, INCLUDING, WITHOUT LIMITATION, THOSE OF MERCHANTABILITY, FITNESS FOR A PARTICULAR PURPOSE AND NON-INFRINGEMENT OR ARISING FROM A COURSE OF DEALING, USAGE, OR TRADE PRACTICE.

IN NO EVENT SHALL CISCO OR ITS SUPPLIERS BE LIABLE FOR ANY INDIRECT, SPECIAL, CONSEQUENTIAL, OR INCIDENTAL DAMAGES, INCLUDING, WITHOUT LIMITATION, LOST PROFITS OR LOSS OR DAMAGE TO DATA ARISING OUT OF THE USE OR INABILITY TO USE THIS MANUAL, EVEN IF CISCO OR ITS SUPPLIERS HAVE BEEN ADVISED OF THE POSSIBILITY OF SUCH DAMAGES.

Any Internet Protocol (IP) addresses and phone numbers used in this document are not intended to be actual addresses and phone numbers. Any examples, command display output, network topology diagrams, and other figures included in the document are shown for illustrative purposes only. Any use of actual IP addresses or phone numbers in illustrative content is unintentional and coincidental.

All printed copies and duplicate soft copies of this document are considered uncontrolled. See the current online version for the latest version.

Cisco has more than 200 offices worldwide. Addresses and phone numbers are listed on the Cisco website at www.cisco.com/go/offices.

Cisco and the Cisco logo are trademarks or registered trademarks of Cisco and/or its affiliates in the U.S. and other countries. To view a list of Cisco trademarks, go to this URL: <https://www.cisco.com/c/en/us/about/legal/trademarks.html>. Third-party trademarks mentioned are the property of their respective owners. The use of the word partner does not imply a partnership relationship between Cisco and any other company. (1721R)

© 2022-2024 Cisco Systems, Inc. All rights reserved.



CONTENTS

PREFACE

About this Guide	xliv
Conventions Used	xliv

CHAPTER 1

Overview	1
Product Description	1
Sx Interface	1
Supported Features and Functionality	2
3GPP ULI Enhanced Reporting Support	2
AAA Server Group	2
APN Configuration Support	2
Asynchronous Core Transfer Support for egtpinmgr	3
Bit Rate Mapping Support	4
Call Log Summary	5
Charging Data Records to HDD	5
GTP-C Path Failure Enhancements and Improved Debugging Tools	5
GTPP Suppress-CDR No Zero Volume	6
Lawful Intercept	6
Location Based DNS and PCSCF IP Address Selection	6
MPRA Support	7
No udp-checksum Support	7
Optimization for egtpinmgr Recovery	8
QUIC IETF Implementation	8
Configuring QUIC IETF	8
Quota Hold Time Support	9
S-GW Paging Enhancement	9
Session Recovery and ICSR at Control Plane	10

SRVCC PS to CS Handover Indication and the QoS Class Index IMS Media Configuration Support **14**

Support for ip hide-service-address CLI Command **16**

Support for regardless-of-other-triggers CLI Command **16**

TFT Suppression for Default Bearer **17**

 Feature Description **17**

 Configuring TFT Suppression **17**

Zero-byte EDR Suppression **18**

How It Works **18**

 Architecture **18**

 User Plane Selection **18**

 Call Flows **19**

 Dedicated Bearer Creation, Modification (Update) and Deletion **31**

 Support for Addition, Deletion and Updation of Dedicated Bearers for S-GW **38**

 LTE Handoff with S-GW Relocation Call Flows **40**

 PDN Update Procedures **53**

 PDN Update Procedures - eNodeB F-TEIDu **56**

 Gx Update Procedures **57**

 P-GW Session Reporting with Gy Interface **57**

 P-GW Session Reporting with Gz Interface **67**

 Standards Compliance **67**

CHAPTER 2 **Configuring Control Plane in CUPS** **69**

 Enabling CUPS in eGTP-C Service for SAEGW **70**

 Verifying CUPS in EGTPC Service for SAEGW **71**

 Recommended Timers **72**

 Recommended Configurations **72**

 Example Configurations in CP **73**

 Example Router Configurations **76**

 Example Configurations in UP **77**

 Example SRP Configurations **78**

CHAPTER 3 **Monitoring and Troubleshooting Control Plane in CUPS** **79**

 Show Command(s) and/or Outputs **79**

show subscribers control-plane-only all	79
show session disconnect-reasons	81
show subscribers saegw-only full all	81
show subscribers saegw-only seid seid_value	82
show user-plane-service statistics charging action	82
show user-plane-service statistics group-of-ruledefs	84
show user-plane-service statistics ruledef	84
SNMP Support	85
Monitoring and Troubleshooting SAEGW Service in CUPS Mode	85
Show Command(s) and/or Outputs	85
show configuration errors	85
Change in Idle Time Value in Control Plane	88

CHAPTER 4	5G NSA for SAEGW in CUPS	91
	Feature Description	91

CHAPTER 5	ADC Over Gx	93
	Feature Description	93
	How It Works	94
	Limitations	96
	Licensing	96
	Configuring ADC over Gx	96
	Monitoring and Troubleshooting	96
	Monitor Protocol	97
	Show Command(s) and/or Outputs	97
	On C-Plane	97
	On U-Plane	97

CHAPTER 6	Addition of IP Pool in IP Group	99
	Revision History	99
	Feature Description	99
	How it Works	100
	Monitoring and Troubleshooting	100
	Show Command(s) and/or Outputs	100

show ip user-plane verbose 100

CHAPTER 7

APN ACL Support 103

Revision History 103

Feature Description 103

Troubleshooting 104

CHAPTER 8

APN AMBR Traffic Policing 105

Revision History 105

Feature Description 105

Limitations 105

Configuring the APN AMBR Traffic Policing Feature 106

Monitoring and Troubleshooting 106

Show Commands and or Outputs 106

CHAPTER 9

APN Data Tunnel MTU Size Configuration 109

Revision History 109

Feature Description 109

Limitation 110

Configuring MTU 110

CHAPTER 10

Bearer Inactivity Timeout 113

Bearer Inactivity Timeout 113

Revision History 113

Feature Description 113

CHAPTER 11

Bulk Statistics Support 115

Feature Description 115

CHAPTER 12

Cisco Ultra Traffic Optimization with VPP 119

Revision History 119

Feature Description 119

RCM Support 120

Sending the GBR or MBR Values to Cisco Ultra Traffic Optimization	120
Cisco Ultra Traffic Optimization Library Deinitialization	121
How it Works	121
Architecture	121
Limitations	122
Show Commands and Outputs	122
Show Commands and Outputs	122
Bulkstats	124
Sample Configuration	128

CHAPTER 13 **Change Notification Support for Pure S** 131

Revision History	131
Feature Description	131
How It Works	131
Call Flow	131

CHAPTER 14 **Charging Action Configuration Change Support for Existing Sessions Gy and Gz Interface** 133

Revision History	133
Feature Description	133
How It Works	134
Configuration Change Under Charging Action from Rated to Free and Free to Rated Mid Call	134
Configuration Change for Addition of High Priority Rule with Different Charging Action with Different Rating Group	134
Configuration Change for Charging-Action Mid Call for the Ruledef	134
URR Bucket Checkpointing Enhancement for Gy	134

CHAPTER 15 **CP Call Summary Log** 135

Revision History	135
Feature Description	135
How it Works	136
S-GW Event Record	136
P-GW Event Record	138
Sx-specific Fields	142
Configuring Call Summary Log in CP	143

- Configuring Call Summary Log in S-GW 144
- Configuring Call Summary Log in P-GW 144
- Verifying Call Summary Log Configuration in CP 144
- Monitoring and Troubleshooting 144
 - Show Command(s) and/or Outputs 144

CHAPTER 16 Dedicated Bearer Establishment without PCRF 147

- Revision History 147
- Feature Description 147
- How it Works 147
 - Sx Interface Changes 149
 - Trigger Action Report IE (Private IE) 150
 - Trigger Actions 150
 - N-1 Compatibility Matrix 151
- Configuring active-charging-services 151

CHAPTER 17 Device ID in EDNS0 Records 153

- Revision History 153
- Feature Description 153
- How it Works 154
 - Process Flow 154
 - EDNS0 Packet Format 155
 - EDNS0 with IP Readdressing 156
 - Behavior and Restrictions 156
 - Limitations 157
- Configuring EDNS Format and Trigger Action 157
 - Sample Configuration 159
- Monitoring and Troubleshooting 160
 - Show Commands and Outputs 160
 - Bulk Statistics 161

CHAPTER 18 DI-Net Encryption 163

- Revision History 163
- Feature Description 163

	How it Works	163
	AES-CBC-256	164
	AES-GCM-256	164
	Encryption Method (iftask_aes_gcm_encrypt)	165
	Decryption Method (iftask_aes_gcm_decrypt)	165
	Limitations	166
	Configuring Encryption Algorithm	166
	Appendix	166
	Cipher Block Chaining	166
	Galois or Counter Mode	167

CHAPTER 19	Disable Radius Accounting	171
	Revision History	171
	Feature Description	171
	Configuring RADIUS Accounting on Dedicated Bearer Feature	172
	Enabling RADIUS Accounting for All Bearers	172
	Disabling RADIUS Accounting for a Specific Bearer	172
	Enabling RADIUS Accounting only for the Default Bearer	173

CHAPTER 20	DSCP Markings For Collapse Calls	175
	Feature Summary and Revision History	175
	Feature Description	175
	How It Works	176
	Configuration	176
	Monitoring and Troubleshooting	177
	Show Commands Outputs	177
	SMGR CP Changes	177

CHAPTER 21	Dynamic and ADC Charging Rule Names	181
	Revision History	181
	Feature Description	181

CHAPTER 22	Dynamic APN and IP Pool Support	183
	Revision History	183

- Feature Description 183
- How It Works 183
 - Limitations 185
- Configuring Dynamic APN and IP Pool Support 185
 - Updating the APN Configuration 186
 - Verifying Dynamic APN and IP Pool Support 186

CHAPTER 23 **ECS Regular Expression Support 189**

- Feature Summary and Revision History 189
- Feature Description 189
- How It Works 190
- Configuring Regex Rule 191
 - Configuring Regex Rule via RCM 192
 - Configuring Regex Rule via PFD Push 192
 - Sample Configuration 192
- Monitoring and Troubleshooting 192
 - Show Commands and Outputs 192

CHAPTER 24 **End Marker Packets 195**

- Revision History 195
- Feature Description 195

CHAPTER 25 **Enterprise Onboarding in CUPS 197**

- Feature Revision History 197
- Feature Description 197
 - Operational Use Case 198
 - Architecture 198
 - Installation 199
- How it Works 199
 - Pre-Processing 200
 - CP and UP Configuration 201
 - Post-Processing 202
 - Add Operation 204
 - Modify Operation 205

Delete Operation	205
Password Encryption	205
Onboarding Application – Usage and Input Parameters	207
CUPSinfo.txt	207
ADD_ENTERPRISE_INPUT_PARAMETERS.txt	209
MODIFY_ENTERPRISE_INPUT_PARAMETERS.txt	212
DELETE_ENTERPRISE_INPUT_PARAMETERS.txt	213
System Limits	214
Enterprise Onboarding in CUPS OAM Support	216
Show Commands	216
show cups-resource session summary	216
show ip user-plane verbose	216
Error Codes	216
<hr/>	
CHAPTER 26	Event-based CDRs for CUPS 219
Revision History	219
Event-based CDRs for CUPS	219
Feature Description	219
How It Works	220
Fetching the Usage Report	220
Tariff Time	221
Event Trigger	221
Standards Compliance	222
Monitoring and Troubleshooting	222
Show Commands and/or Outputs	222
show active-charging subscribers full callid call_id urr-info	222
show subscribers user-plane-only callid call_id urr full all	222

CHAPTER 27	Event Data Records in CUPS 223
Revision History	223
Feature Description	223
TCP Fast Open	224
How It Works	224
Limitations	227

- Configuring Event Data Records in CUPS 227
 - Configuration on CP to Push EDRs to UP 227
 - Configuration to Enable EDR Module on UP 228
 - Configuring Additional TCP Fields 228
- Monitoring and Troubleshooting 228
 - show user-plane-service statistics rulebase name rulebase_name 228
 - show active-charging rulebase statistics real-time 229
 - show active-charging edr-format all 230
 - Bulks Statistics 231

CHAPTER 28

Error Indication and GTPU Path Failure Detection 233

- Revision History 233
- Feature Description 233
- How It Works 234
 - Error Indication Support 234
 - Error Indication Handling at CP 234
 - Error Indication Handling on UP 234
 - Error Indication Generation on UP 235
 - Error Indication Call Flows 235
 - GTPU Path Failure Support 238
 - GTPU Path Failure Support at CP 238
 - GTPU Path Failure Support at UP 239
 - Limitations 240
- Configuring Error Indication and GTPU Path Failure on Control Plane 240
 - Configuring Error Indication on CP 240
 - Configuring GTPU Path Failure on CP 241
 - Limitations 242

CHAPTER 29

Firewall Support in CUPS 243

- Revision History 243
- Feature Description 243
 - Overview 244
- Configuring the Default Firewall Feature 244
 - Enabling Firewall for IPv4 and IPv6 245

Configuration Support for Subscriber Firewall	245
Monitoring and Troubleshooting	246
Show CLIs for CUPS	247
SNMP Traps	247
Reassembly Behavior Change	248

CHAPTER 30

FUI Redirection	249
Revision History	249
Feature Description	249
Limitations	250
Appending Original URL to Redirect URL	250
How it Works	250
Limitations	251
Configuring Redirect URL Token	251

CHAPTER 31

GGSN in CUPS	253
Revision History	253
Feature Description	253
Supported Functionality	254
Standards Compliance	254
How it Works	255
Initial Attach GnGp	255
Detach (GnGp)	257
Context Replacement	258
Update Procedure and QoS Interaction	258
Access side Update Procedure	259
Gx Update Procedures	259
PGW to GGSN Handoff	260
GGSN to PGW Handoff	261
Inter-SGSN Handoff Iu 3G to Iu 3G	262
Inter SGSN Handoff for AGb 2G to Iu 3G	263
Inter SGSN Handoff for Iu 3G to AGb 2G	264
Direct Tunnel	264
PCRF-initiated Deletion of Session	265

- Admin Clear 266
- Network Failures 268
- GGSN Session Reporting with Gy Interface 268
- GGSN Session Reporting with Gz Interface 268
- Secondary PDP Context Behavior 268
 - SGSN Initiated Secondary PDP Context 268
 - PCRF initiated Secondary PDP Context 269
- Recovery and ICSR for GGSN in CUPS 272
- Limitations 272
- Configuring GGSN in CUPS 272
 - Enabling CUPS in GGSN Service 273
 - Enabling CUPS in GTPC Service for GGSN 273
 - Verifying CUPS in GGSN Service for SAEGW 273
 - Supported Custom CLI Commands 273

CHAPTER 32 GTPC Peer Record and Statistic Optimization 275

- Revision History 275
- Feature Description 275
- How it Works 275
- Limitations and Restrictions 276
- Configuring the Peer Salvation Functionality 276
 - gtpc peer-salvation (context configuration mode) 277
 - gtpc peer-salvation (eGTP service configuration mode) 277
- Monitoring and Troubleshooting 278
 - show egtp-service all 278
 - show session subsystem debug-info 278
 - show demux-mgr statistics egtpinmgr all 278
 - show demux-mgr statistics egtpegmgr all 278

CHAPTER 33 Gx-alias Enhancement 281

- Revision History 281
- Feature Description 281
- How it Works 281
 - Call Flow 282

Limitation 284

CHAPTER 34**Gx AVP for UP Identification 285**

Revision History 285

Feature Description 285

Gx Attribute Value Pair (AVP) 285

CHAPTER 35**Handling Simultaneous Gy RARs from Different DRAs with Different RGs 287**

Revision History 287

Feature Description 287

How it Works 287

Configuring the Feature 289

Monitoring and Troubleshooting 290

Show Commands and Outputs 290

show active-charging service all 290

CHAPTER 36**Host Route Explicit Advertisement 291**

Revision History 291

Feature Description 291

How it Works 291

Limitations 292

Configuring Host Route Explicit Advertisement 292

CHAPTER 37**ICSR Bulk Statistics 295**

Revision History 295

Feature Description 295

Configuring the ICSR Bulk statistics Schema 295

Show CLIs 296

Bulk Statistics 296

CHAPTER 38**Idle Timer for SAE-GW Sessions 299**

Revision History 299

Feature Description 299

Limitations 299
 Configuring Idle Timer for SAE-GW Sessions 300

CHAPTER 39

IFTASK Hyperthreading 301

Revision History 301
 Feature Description 301
 How it Works 301
 Limitations and Restrictions 302
 Configuring CPU Isolation 302

CHAPTER 40

Indirect Forwarding Tunnel 303

Revision History 303
 Feature Description 303
 How It Works 304
 Call Flow 304
 Supported Functionality 307
 Configuring Indirect Forwarding Tunnel 307
 Enabling Indirect Forwarding Tunnel Feature 307
 Verifying the Indirect Forwarding Tunnel Feature 308
 show sgw-service name <service_name> 308
 Monitoring and Troubleshooting 308
 Show Commands Input and/or Outputs 308
 show subscribers saegw-only full all 308
 show subscribers user-plane-only callid <call-id> pdr all 308
 show subscribers user-plane-only full all 309

CHAPTER 41

IP Pool Management 311

Revision History 311
 Feature Description 311
 How It Works 312
 Handling UP De-Registration 312
 Hold Timer 312
 IP Pools per Context 314
 IP Resource Management 314

IP Resource Replenishment/Withdrawal Procedure	314
No-chunk-pool for One UP per UP Group	315
Static IP Pool Management	316
UP Selection	316
UP Selection based on IP Pool Chunk Availability	317
Supported Functionality	317
Limitations	317
Configuring IP Pool Management	319
At Control Plane	319
Configuring Chunk-size Value	321
At User Plane	321
Configuring User Planes for a System	321
Monitoring and Troubleshooting	322
Show Command(s) and/or Outputs	322
show ip pool-chunks pool-name <pool-name>	322
show ip pool-chunks pool all	323
show ip pool-chunks up-id <up_id> user-plane-group name <grp-name>	323
show ip user-plane chunks	324
show ip user-plane prefixes	324
show ip user-plane verbose	324
show ip user-plane	326
show ipv6 pool-chunks pool-name <pool-name>	326
show ipv6 pool-chunks up-id <up_id> user-plane-group name <grp-name>	326

CHAPTER 42**IPSec in CUPS 327**

Revision History	327
Feature Description	327
IPSec AH and ESP	327
IPSec Transport and Tunnel Mode	328
IPSec Terminology	328
Crypto Access Control List	328
Transform Set	328
ISAKMP Policy	328
Crypto Map	329

Crypto Template	329
DSCP Marking of ESP Packets	329
Application Configured with DSCP Value	329
Crypto Map Configured with DSCP Value	330
Application and Crypto Map Configured with DSCP Value	331
Supported Algorithms	332
Limitations and Restrictions	333
Configuring DSCP in Crypto Map	334
Sample Configuration	334
Configuring QoS	335
Monitoring and Troubleshooting	336
Show Commands and Outputs	336

CHAPTER 43	L2 Marking Support	341
	Revision History	341
	Feature Description	341
	How it Works	341
	Limitations	343
	Configuring L2 Marking Support	343
	Configuring Internal Priority	343
	Associating QCI-QoS Mapping Table	344
	Configuring QCI Derived L2 Marking	344
	Associating L2 Mapping Table	345
	Configuring DSCP Derived L2 Marking	345

CHAPTER 44	L3, L4, and L7 Rule Combination in Ruledef	347
	Revision History	347
	Feature Description	347
	How it Works	348
	Enhanced ACS Feature	348
	Enabling Enhanced ACS Feature	349
	Configuring the L3, L4, and L7 Rule Combination in Ruledef Feature	349
	Verifying the L3, L4, and L7 Rule Combination in Ruledef Feature Configuration	350
	Monitoring and Troubleshooting	350

Show commands and Outputs 350

CHAPTER 45

Local Policy in CUPS 353

Revision History 353

Feature Description 353

How It Works 354

Configuring Local Policy in CUPS 354

CHAPTER 46

Load/Overload and UP Data Throttling Support on Sx 357

Feature Description 357

How It Works 357

User Plane Selection 357

Node-level Load/Overload Support 358

Sx Establishment Request Throttling at CP in Overload State 358

Sx Establishment Request Throttling at UP in Self-Protection 358

Session Termination Trigger from UP in Self-Protection 358

Limitation 359

Configuring Load and Overload Support 359

User Plane Load Control Profile Configuration 359

User Plane Overload Control Profile Configuration 360

Associating a Load Control Profile with a User Plane Service 363

Sx Protocol Configuration on Control Plane 363

Monitoring and Troubleshooting 363

Show Commands Input and/or Outputs 363

show userplane-load-control-profile name name 363

show userplane-overload-control-profile name name 364

show user-plane-service statistics all 365

show sx service statistics all 366

Bulk Statistics 366

SNMP Traps 367

CHAPTER 47

LTE-M RAT Type Support 369

Revision History 369

Feature Description 369

How it Works	370
Limitations	371
Supported Standards	371
Configuring LTE-M RAT-Type	372
Configuring Virtual APN Selection based on LTE-M RAT Type	372
Configuring QCI - QoS Mapping	372
Monitoring and Troubleshooting	373
Show Commands and Output	373
show apn statistics { all name }	373
show subscribers { full full all call-id <call_id> }	373
show subs { pgw-only sgw-only saegw-only } { full full all }	373
show session subsystem [full verbose]	373
show session summary	374
show subscribers { subscription full activity all }	374
show { pgw-service sgw-service saegw-service } statistics { all name }	374
Bulk Statistics	374
APN Schema	374
P-GW Schema	375
S-GW Schema	375
SAEGW Schema	375

CHAPTER 48**LTE - Wi-Fi Seamless Handover in CUPS 377**

Revision History	377
Feature Description	377
How It Works	378
LTE - Wi-Fi Handover	378
ICSR and Session Recovery	379
Limitations	379
Standards Compliance	379
Configuring LTE and Wi-Fi Seamless Handover	379
Monitoring and Troubleshooting	380
Show Command(s) and/or Outputs	380
show apn statistics name <name>	380

CHAPTER 49**Monitor Subscriber for CUPS 381**

- Revision History 381
- Feature Description 381
- Monitor Subscriber Sx Private IE 383
- Control Plane SMGR Functionality 387
- User Plane SMGR Functionality 387
- Multi PDN Multi Trace 388
- MonSub Stats 389
- X-Header 389
- How It Works 389
 - Configuration Procedure for Monitor Subscriber on UPF 389
 - Monsub CLI Options 390
 - Context, CDRMOD, and Hexdump Interaction for Monitor Subscriber 392
 - PCAP File Name Convention 392
 - PCAP File Location 395
 - Limitations 395
- Configuring the Hexdump Module for MonSub in UPF 397
 - Configuring MonSub Poll Timer 397
 - Configuring MonSub File Name 397
- Monitoring and Troubleshooting 398
 - SNMP Traps 398

CHAPTER 50**MPLS Support on VPC-SI for CUPS 399**

- Revision History 399
- Feature Description 399
- How it Works 400
 - MPLS-CE Connected to PE 400
 - VPC-SI as a PE 401
 - Overview 401
 - Sample Configuration 401
 - IPv6 Support for BGP MPLS VPNs 402
 - Overview 402
 - Sample Configuration 403

VPN-Related CLI Commands 406
 Monitoring and Troubleshooting 410
 Show Commands and Outputs 410
 show mpls fn vpp 411

CHAPTER 51 Multiple Control Plane Support on User Plane 413

Revision History 413
 Feature Description 413
 How it Works 414
 Configuring Multiple Control Plane Support on User Plane 416
 Disabling PFD Configuration Push from CP 416
 Configuring Multiple CP on UP 416
 Monitoring and Troubleshooting 417
 Show Commands and/or Outputs 417
 show sx-service statistics address <ip_address> 417
 show user-plane-service statistics peer-address <ip_address> 419
 show ip chunks peer <ip_address> 421
 show ipv6 chunks peer <ip_address> 421
 Sample RCM Configuration 422

CHAPTER 52 MOCN Special Handling of CRA and CNR 429

Revision History 429
 Feature Description 429
 TAI Change Event Handling 430
 How It Works 431
 Start Reporting TAI Change 431
 Stop Reporting TAI Change 432

CHAPTER 53 NAT Support 435

Feature Summary and Revision History 435
 Revision History 435
 Feature Description 435
 Limitations 436
 Configuring NAT in CUPS 437

Sample Configurations	437
Control Plane	437
User Plane	438
Monitoring and Troubleshooting	439
Gathering NAT Statistics	439
Clear Commands	439
SNMP Traps for NAT Parameter Thresholds	439
Bulk Statistics	440
Context Schema	440
ECS Schema	441
NAT-realm Schema	442
EDRs	444
Sample EDR	444
NAT Binding Records	445
Sample NBR	445
Packet Drop EDR	445
Sample Packet Drop EDR	445

CHAPTER 54

NAT ALG Support	447
Feature Summary and Revision History	447
Revision History	447
Feature Description	447
Components of Session Initiation Protocol ALG	448
How it Works	450
FTP	451
RTSP	451
PPTP	451
SIP	451
TFTP	451
H323	452
NAT FW Processing	452
Uplink Packet Processing	453
Downlink Packet Processing	453
Configuring NAT ALG	453

Sample Configuration for FTP NAT ALG 454

Sample Configuration for RTSP NAT ALG 455

Sample Configuration for PPTP NAT ALG 455

Sample Configuration for TFTP NAT ALG 456

Sample Configuration for H323 NAT ALG 457

Sample Configuration for SIP NAT ALG 457

Monitoring and Troubleshooting 458

CHAPTER 55

Netloc and RAN/NAS Cause Code 463

Revision History 463

Feature Description 463

Configuring Netloc and RAN/NAS Cause Code 464

CHAPTER 56

Network Triggerred Service Restoration 465

Feature Description 465

Configuring NTSR 465

 APN Profile Configuration 466

 Peer Profile Configuration (Ingress) 466

 NTSR Pool Configuration 466

 S-GW Service Access Peer Map Association 467

Monitoring and Troubleshooting 467

 Show Commands Input and/or Outputs 467

 show apn-profile full all 467

 show apn-profile full name apn_name 467

 show ntsr-pool all 468

 show ntsr-pool full all 468

 show ntsr-pool full pool-id pool_id 468

 show ntsr-pool pool-id pool_id 468

 show sgw-service statistics all 468

 show subscribers sgw-only full all 469

CHAPTER 57

Network Provided Location Indication 471

Revision History 471

Feature Description 471

How It Works	471
Supported Functionality	472
Limitations	472

CHAPTER 58
NextHop Forwarding Support IPv4/v6 Address 473

Revision History	473
Feature Description	473
How It Works	473
Architecture	473
Configuring NextHop Forwarding Support IPv4/IPv6 Address	477
Configuring NextHop Forwarding at APN Configuration Mode	477
Configuring NextHop Forwarding at IP Pool	477
Configuring NextHop Forwarding Through AAA	478
Monitoring and Troubleshooting	478
Show Commands and Outputs	478

CHAPTER 59
NSO-based Configuration Management 479

Feature Description	479
Use Cases	479
How it Works	480
Architecture	480
RCM and NSO	481
Components	481
Minimum Platform, Hardware, and Software Requirements	482
Licensing	482
NSO Installation	483
Call Flows	483
Onboarding Existing 4G CUPS VNFs into NSO	483
4G CUPS Device Configuration Push – Manual	484
Configuration Push from NSO to 4G CUPS UPs in N:M Redundancy – Automated	485
Configuration Metadata Pre-population	486
NSO HA Switchover Handling	487
Recovery	487
CP Switchover (1:1)	488

- UP Switchover (1:1) 488
- UP Switchover (N:M) 488
- Out-of-Band Configuration 489
- Sensitive Elements in Configuration 489
- Lawful Intercept 489
- CUPS Configuration MOP 490
 - Device Onboarding 490
 - RESTCONF 490
 - CLI 491
 - Prepopulating Configuration Metadata 491
 - RESTCONF 494
 - CLI 495
 - Configuration Push through Mobility MOP 495
 - Configuration MOP Push Request Flow 495
 - Configuration MOP Rollback Request Flow 496
 - MOP Automation 497
 - Configuration Prerequisites 497
 - Mop-type Pair Prerequisites 498
 - NSO APIs 498
 - UP Configuration Push and Recovery in N:M Redundancy 515
 - NETCONF Notification Subscription on NSO 516
 - Handle RCM UP Recovery Notification 516
 - RCM UP Config-Push Notification 517
 - UP Day-0.5 Update 519
 - Prerequisites for Configuration Push 520
 - Limitations and Restrictions 521
- Troubleshooting 522
- Appendix A: Incompatible StarOS Native Command Syntax 523
- Appendix B: Example Configurations for N:M Deployment with RCM 526
 - Host-specific Configuration-UP 526
 - First Active UP 526
 - Second Active UP 527
 - Host-specific Configuration-RCM 528
 - First Active RCM 528

	Second Active RCM	530
	Common Configuration	531
	Standby Configuration (Active1 + Active2)	535
<hr/>		
CHAPTER 60	NSO Orchestration for 4G CUPS	539
	Feature Description	539
	Use Cases	539
	How it Works	540
	Architecture	540
	Minimum Platform and Software Requirements	542
	Network and Hardware Requirements	543
	Licensing	543
	Call Flows	543
	VNF Onboarding	544
	P2P Module Installation	545
	VNF Termination	545
	Recovery	546
	Limitation	546
	Installing NSO Packages	546
	VNF Orchestration/Deployment and Automatic Configuration Management	547
	Pre-population of Config Metadata for VNF Orchestration	547
	Onboarding ESC and Openstack as Devices	552
	Prerequisites for VNF Instantiation	557
	VNF Instantiation	558
	VNF Instantiation - Component Interactions and Flows	563
	Checking the VNF Instantiation Status	566
	VNF Dashboard	566
	VNF Deletion	566
	Checking the VNF Deletion Status	568
	Removing Configuration Metadata	568
	Cleaning Config Files from NSO Filesystem	568
	Automation Process - VNF Deployment, Onboarding, and Configuration Push	568
	Instantiation of VNF using Input Payload	568
	Onboarding VNF as a Device in NSO	568

Installing the P2P Module in VPC Device	568
Configuration Push to the Onboarded Device	568
Appendix A: YANG definition of VNF	569
Appendix B: Generic Upgrade Steps of Mobility Function Pack (MFP)	576
Appendix C: P2P Priority Upgrade	582

CHAPTER 61

NSH Traffic Steering	587
Revision History	587
Feature Description	587
Post Processing Rule Condition Match for Traffic Steering	588
BFD Instance Id Configuration in UP Appliance Group Using Interface Names	588
Architecture—Standalone Mode	588
Components	590
Limitations	591
How it Works—Standalone Mode	592
Packet Flows	592
NSH Traffic Steering Requirements	593
SFP Selection	595
Interworking with Inline Features	595
Configuring the L2 and NSH Traffic Steering Feature—Standalone Mode	596
N to M Traffic Steering	600
Monitoring and Troubleshooting—Standalone Mode	605
SNMP Traps	611
Bulk Statistics	611
Feature Description—Sandwich Mode	612
Architecture—Sandwich Mode	612
How it Works—Sandwich Mode	614
Packet Flows in Sandwich Mode	614
Service-Scheme Selection for Traffic Steering	617
Default Service Chain	618
SFP Selection	618
Limitations and Restrictions	618
Configuring NSH Traffic Steering—Sandwich Mode	619
CP Configuration	619

UP Configuration	620
Configuring Post Processing Ruledef in Both Standalone and Sandwich Mode	622
Configuring BFD Instance Id Using Interface Name in UP Appliance Group	622
Monitoring and Troubleshooting the NSH Traffic Steering—Sandwich Mode	623
Show Commands	623
show user-plane traffic-steering up-appliance-group all	624

CHAPTER 62**Password Encryption Improvement 625**

Revision History	625
Feature Description	625
How it Works	625
Symmetrical Encryption Occurrences	626
Configuring Encryption Password	627
Encryption of System Level and Admin Passwords	627

CHAPTER 63**PDI Optimization 629**

Feature Summary and Revision History	629
Revision History	629
Feature Description	629
Relationships	630
How It Works	630
PDI Optimization Changes on Control Plane	630
Create Traffic Endpoint IE	631
Created Traffic Endpoint IE	632
Update Traffic Endpoint IE	632
Remove Traffic Endpoint IE	633
PDI Changes in Create PDR	633
PDI Optimization Changes on User Plane	633
Handling of Create Traffic Endpoint	633
Handling of Update Traffic Endpoint	633
Handling of Remove Traffic Endpoint	634
Handling of Create PDR	634
Session Recovery and ICSR	634
Control Plane	634

User Plane	635
Standards Compliance	635
Limitations	635
Configuring the PDI Optimization Feature	635
Enabling PDI Optimization	635
Verifying the PDI Optimization Feature Configuration	636
PDI Optimization OAM Support	636
Show Command Support	636
show subscribers user-plane-only callid <call_id> pdr all	636
show subscribers user-plane-only callid <call_id> pdr full all	636

CHAPTER 64	P-GW CDR in CUPS	637
	Revision History	637
	Feature Description	637
	Limitations	638
	User Location Information in P-GW CDR	638

CHAPTER 65	P-GW Restart Notification	641
	Revision History	641
	Feature Description	641

CHAPTER 66	Post Processing Interaction for DCCA	643
	Feature Description	643
	Normal Rule Matching	643
	Application Processing	644
	Post Processing	644
	Limit Reached Post Processing	645
	Configuring Post Processing	645

CHAPTER 67	Priority Recovery Support for VoLTE Calls	647
	Feature Summary and Revision History	647
	Feature Description	647
	How It Works	647
	Call Flows	649

Configuration	650
Monitoring and Troubleshooting	651
Show Commands and Outputs	651

CHAPTER 68**QoS Group of Ruledefs Support 653**

Revision History	653
Feature Descriptions	653
How It Works	653
Data Path Enforcement	654
Static Configuration Push to UPlane	654
QGR Params Push to UPlane	654
Processing of QGR on UPlane	655
QGR Hit in Data Path	656
Limitations	656
Monitoring and Troubleshooting	656
Show Commands and Outputs	656

CHAPTER 69**RADIUS in C-Plane 663**

Revision History	663
Feature Description	663
How It Works	663
C-Plane Handling of RADIUS	664
U-Plane Handling of RADIUS	664
Information Elements for Packet Reporting	665
Limitation and Restriction	665
Configuring RADIUS in C-Plane	665
Monitoring and Troubleshooting	666

CHAPTER 70**Radius Packet Disconnect 667**

Revision History	667
Feature Description	667
High Level Requirements	667
Change-of-Authorization Messages	668
Message Exchange	668

RADIUS-Initiated Disconnect Messages 668
 Message Exchange 669
 Configuring Radius Change Authorization NAS-IP-Address Functionality 669

CHAPTER 71 **RADIUS Server State 671**
 Revision History 671
 Feature Description 671
 How it Works 671
 Configuring AAA RADIUS Servers 672
 Monitoring and Troubleshooting 672
 Show Commands and Outputs 673

CHAPTER 72 **Rate Limiting Function (RLF) 675**
 Revision History 675
 Feature Description 675

CHAPTER 73 **S2a Interface Support 677**
 Revision History 677
 Feature Description 677

CHAPTER 74 **S2b Interface Support 679**
 Feature Description 679

CHAPTER 75 **S6b Support 681**
 Revision History 681
 S6b Support 681

CHAPTER 76 **S-GW CDR in CUPS 683**
 Revision History 683
 Feature Description 683

CHAPTER 77 **S-GW New Call Rejection 685**
 Feature Description 685

How It Works	685
Limitations	686
Configuring S-GW New Call Rejection	686
Enabling New Call Rejection	686
Monitoring and Troubleshooting	687
Show Command(s) and/or Outputs	687
show saegw-service statistics all function sgw	687
show sgw-service name	687

CHAPTER 78**SAEGW Idle Buffering with DDN Delay and DDN Throttling 689**

Revision History	689
Feature Description	689
How It Works	690
Downlink Data Notification – Delay (DDN-D) Support	690
DDN Throttling Support	691
No User Connect Timer Support	691
DDN Call Flows	692
DDN Success Scenario	692
DDN Failure Scenario	693
No User Connect Timer Support	694
DDN Delay Timer	695
Sx Interface	696
Limitations	698
SAEGW Idle Buffering with DDN Delay and DDN Throttling Support Configuration	699
DDN Throttling for Release 10 Compliant MME	699
DDN Throttling for non-Release 10 Compliant MME	699
Configuring Buffering Limit	701
Show Commands Input and/or Outputs	701
show subscribers user-plane-only-full all	701
show user-plane-service statistics all	702

CHAPTER 79**Secondary RAT Usage Report in CDR Records 703**

Revision History	703
Feature Description	703

- Behavior Matrix 704
- Relationship to Other Features 706
- Limitations 706
- Configuring Secondary RAT Usage Report through GTPP 707
 - Enabling or Disabling the Secondary RAT Usage Report 707
 - Controlling the Maximum Number of Entries 707
 - Suppressing Zero-Volume Secondary RAT Usage Report 710
- Monitoring and Troubleshooting 710
 - Show Commands and Outputs 710
 - show config 710
 - show config verbose 711
 - show gtp group 711
 - show gtp statistics group 711

CHAPTER 80

Secondary RAT Usage During GnGp Handover 713

- Revision History 713
- Feature Description 713
 - IMSI Not Known 714
 - Limitation 714
- Configuring Secondary RAT Usage during GnGp Handover 715
 - Enabling Secondary RAT Data Usage Report 715

CHAPTER 81

Self-overload Detection and Admission Control of Sx at UP 717

- Revision History 717
- Feature Description 717
 - Limitations 718
- Configuring Overload Control at User Plane 718
 - eMPS Profile Creation and Association to S-GW and P-GW Services of Control Plane 718
 - Configuring the Overload Control Profile at UP 719
 - Configuring Overload Threshold Parameters 719
 - Configuring System Weightage Parameters 719
 - Configuring Session Manager Weightage Parameters 720
 - Associating an Overload Control Profile with a User Plane Service 720
- Monitoring and Troubleshooting 720

Show Commands Input and/or Outputs	720
show user-plane-service name name	720
show user-plane-service statistics name user_plane_service_name	721
show userplane-overload-control-profile name name	721

CHAPTER 82**Smart Licensing 723**

Revision History	723
Overview	723
Cisco Smart Software Manager	724
Smart Accounts/Virtual Accounts	724
Smart Licensing Mode	724
Request a Cisco Smart Account	725
Software Tags and Entitlement Tags	725
Configuring Smart Licensing	728
Monitoring and Troubleshooting Smart Licensing	729

CHAPTER 83**Software Management Operations 731**

Revision History	731
Overview	731
SNMP Traps	732
Limitations	733
Upgrading or Downgrading of CP and UP	733
Health Checks	733
Build Upgrade	735
CP Upgrade	736
UP Upgrade	737
CP and UP Upgrade	737
Downgrade Procedure	738

CHAPTER 84**Standard QCI Support 741**

Revision History	741
Feature Description	741
Limitations	742
Configure QCI	742

Monitoring and Troubleshooting 743

- Show Command(s) and/or Outputs 743
 - show subscribers saegw-only imsi <imsi> 743
 - show apn statistics 743
 - show active-charging sessions full all 744
 - show qci-qos-mapping table name name 745
- Bulk Statistics 745
 - show bulkstats variables saegw | grep qci67 745

CHAPTER 85 **Static IP Assignment from RADIUS 747**

- Feature Description 747
- How it Works 747
- Limitations 747

CHAPTER 86 **Support for Duplicate New Call 749**

- Revision History 749
- Feature Description 749
- Limitations 749

CHAPTER 87 **Suspend and Resume Notification for Pure-S Calls 751**

- Revision History 751
- Feature Description 751
- How It Works 751
 - Call Flows 752
 - Suspend Notification 752
 - Resume Notification 752

CHAPTER 88 **TACACS+ Over IPsec 755**

- Revision History 755
- Feature Description 755
 - Architecture 755
 - Deployment Architecture 756
- How it Works 757
 - Encryption of TACACS+ Client Data 757

Decryption of TACACS+ Server Data	758
Recovery	760
Limitation	760
Configuring TACACS+ over IPsec	760
Configuring TACACS+ Configuration Mode	761
Provisioning TACACS+ with IPsec	761
Provisioning TACACS+ with IPsec in Tunnel Mode	761
Provisioning TACACS+ with IPsec in Transport Mode	762
Monitoring and Troubleshooting	763
Show Commands and Outputs	763

CHAPTER 89
Tariff Time Support 765

Revision History	765
Feature Description	765

CHAPTER 90
TEID Collision Handling during MOCN 767

Revision History	767
Feature Description	767
How it Works	767
Call Flows	768
TEID Collision with ULI Change on GGSN	768
TEID Collision with ULI Change for P-GW	769
Configuring TEID Collision with ULI Change	770
Configuring TEID Collision with ULI Change on GGSN	770
Configuring TEID Collision with ULI Change on P-GW	771
Monitoring and Troubleshooting	771
Show Commands and Outputs	771
show egtpc statistics	771
show gtpc statistics	773
show ggsn-service name ggsn-service more	773
show pgw-service name	773

CHAPTER 91
URL Blockedlisting 775

Revision History	775
------------------	-----

Feature Description	775
How it Works	775
Limitations	776
Configuring URL Blockedlisting	777
Loading URL Blockedlisting Database on UP	777
Configuration to Enable URL Blockedlisting	777
URL Blockedlisting Database Upgrade	778
Monitoring and Troubleshooting	778
Show Command(s) and/or Outputs	778
show user-plane-service url-blacklisting database	778
show user-plane-service url-blacklisting database url database_directory_path	779
show user-plane-service url-blacklisting database facility sessmgr all	779
show user-plane-service inline-services info	780
show user-plane-service rulebase name rulebase_name	780
show user-plane-service inline-services url-blockedlisting statistics	780
show user-plane-service inline-services url-blacklisting statistics rulebase name rulebase_name	780
Bulk Statistics	780
SNMP Traps	780

CHAPTER 92
User Plane Selection 783

APN and APN Profile-Based User Plane Selection	783
Revision History	783
Feature Description	783
How It Works	784
Architecture	785
Session Recovery and ICSR	785
Limitations	785
Licensing	786
Configuring APN-Based UP Grouping	786
Configuring User Plane Group in Control Plane	786
Configuring User Plane Group	786
Configuring Peer Node ID and User Plane Node IP Address	786
Verifying the User Plane Group	786
Associating User Plane Group with APN	787

Configuring User Plane Group in APN	787
Verifying the User Plane Group in APN	787
Associating User Plane Group with APN Profile	787
Configuring User Plane Group in APN Profile	787
Method of Procedure (MOP) to Remove or Change User Plane Group from APN	787
Monitoring and Troubleshooting APN-Based UP Grouping	788
Dynamic User Plane Selection	788
Revision History	788
Feature Description	789
Architecture	789
How it Works	789
Call flows	791
Limitations	796
Configuring the Dynamic User Plane Selection Feature	796
Configuring FQDN for P-GW or GGSN	796
Configuring FQDN for S-GW	796
Boxer Configurations	797
DNS Server Configurations	797
S6b Configuration (Optional)	799
Interface	799
Show Commands	802
Bulk Statistics	803
Multiple UP Group Support	803
Revision History	803
Feature Description	804
Relationships	804
Architecture	804
Components	804
How It Works	805
Limitations and Restrictions	805
Configure the Multiple UP Group Support Feature	805
Priority between UP Groups	807
Revision History	807
Feature Description	807

How It Works	807
Support of UP Group Specific IP Pool	808
IP Pool Chunk Allocation to UP	809
DNS-Based UP Selection Algorithm on Multiple UP Groups	810
Limitations	811
Configuring IP Pool Management Policy and UP Group with Specific IP Pool	812
MOP for Adding and Deleting UP and UP Group	813
Sample Configuration	816
Verifying IP Pool Management Policy Configuration	817
User Plane Selection based on TAC Range	817
Revision History	817
Feature Description	817
How It Works	818
Limitations	818
Configuring User Plane Selection based on TAC Range	819
Configuring Tracking Area Code Range	819
Verifying the Tracking Area Code Range Configuration	820
Configuring Tracking Area Code Profile	820
Verifying the Tracking Area Code Profile Configuration	820
Configuring Routing Area Code Profile	821
Verifying the Routing Area Code Profile Configuration	821

CHAPTER 93**User Plane Node Bring Down Procedure 823**

Revision History	823
Feature Description	823
Preconditions	824
How it Works	824
Call Flow	824
UP Selection when a UP is Marked Busy Out	824
UP Clear Idle Subscribers based on Busy Out Inactivity Timeout	825
Limitations and Considerations	825
Configuring UP Node Bring Down Procedure	826
Monitoring and Troubleshooting	826
Show Commands and Outputs	826

show sx peers 826
 show sx peers wide 827

CHAPTER 94	Virtual APN in CUPS	829
	Revision History	829
	Feature Description	829
	How It Works	830
	Call Flow	830
	Limitations	831
	Configuring Virtual APN in CUPS	832

CHAPTER 95	VoLTE Support in CUPS	835
	Revision History	835
	Feature Description	835
	How It Works	836
	Call Flows VoLTE Support	836
	Handling Suspend Notifications	836
	Handling Resume Notifications	837
	Limitations	838

CHAPTER 96	Volume Reporting over Gx	839
	Revision History	839
	Feature Description	839
	How it Works	840
	Control Plane Handling for VoGx	840
	User Plane Handling for VoGx	841
	Limitations	841
	Configuring VoGx Monitoring Key Range	842
	Monitoring and Troubleshooting VoGx	842
	Show Commands and/or Outputs	842

CHAPTER 97	VPP Support	845
	Revision History	845
	Charging Support	846

- Delay-Charging Via Rule Base 846
- Flow Idle-time Out 847
- HTTP Support 847
- IP Readdressing 847
- DNS Readdress Server List 847
- LTE Handover 849
- Next Hop 849
- PDN Update 849
- Policing 850
- Pure-S Support 851
- Response-based Charging via Service Schema 851
- Response-based TRM via Service Schema 851
- ToS Marking 851
- Volume-based Offload 852
- Supported Functionality 852
- Limitations 853
- Enabling Fast Path in User Plane Service 853
- Enabling VPP on SI Platform 853
- Monitoring and Troubleshooting VPP Fast Path 854
- Support for VPP Configuration Parameters Override 854

CHAPTER 98

VRF Support for CUPS 855

- Revision History 855
- Feature Description 855
 - VPNMgr Crash Outage Improvement for IP Pool under VRF 856
- Configuring VRF 857
- Monitoring and Troubleshooting 859
 - Show Command(s) and/or Outputs 860
 - show ip chunks 860
 - show ipv6 chunks 860

CHAPTER 99

X-Header Insertion and Encryption 861

- Revision History 861
- Feature Description 861

How It Works	861
X-Header Insertion	861
X-Header Encryption	862
Configuring X-Header Insertion and Encryption	862
Configuring X-Header Insertion	863
Configuring X-Header Encryption	864
Verifying the X-Header Insertion and Encryption Configuration	865
Monitoring and Troubleshooting the X-Header Insertion and Encryption feature	865

APPENDIX A

IP Pool Planning Guidelines	867
IP Distribution in CUPS Architecture	867
UP Group Concept	867
Default UP Group	868
Specific UP Group	868
When to Add New Pool	868
IP Pool Fine-tuning Parameters	870
Threshold Timer	870
Chunk Withdrawal	870
Initial Chunk Pushed	870
Chunk Size	871
Dynamic IP Pool Planning Guidelines	871
Chunking Guidelines	871
UP Grouping Guidelines	872
UP Addition Guidelines	872
Miscellaneous Guidelines	872
Static IP Pool Guidelines	873
Implications of Taking Very Big Chunk Size	873



About this Guide



Note Control and User Plane Separation (CUPS) represents a significant architectural change in the way StarOS-based products are deployed in the 3G, 4G, and 5G networks. This document provides information on the features and functionality specifically supported by this 3G/4G CUPS product deployed in a 3G/4G network. It should not be assumed that features and functionality that have been previously supported in legacy or non-CUPS products are supported by this product. References to any legacy or non-CUPS products or features are for informational purposes only. Furthermore, it should not be assumed that any constructs (including, but not limited to, commands, statistics, attributes, MIB objects, alarms, logs, services) referenced in this document imply functional parity with legacy or non-CUPS products. Please contact your Cisco Account or Support representative for any questions about parity between this product and any legacy or non-CUPS products.



Note The documentation set for this product strives to use bias-free language. For purposes of this documentation set, bias-free is defined as language that does not imply discrimination based on age, disability, gender, racial identity, ethnic identity, sexual orientation, socioeconomic status, and intersectionality. Exceptions may be present in the documentation due to language that is hardcoded in the user interfaces of the product software, language used based on RFP documentation, or language that is used by a referenced third-party product.

This guide describes the Control Plane (CP) functionality in Control and User Plane Separation (CUPS). This document also contains feature descriptions, configuration procedures, and monitoring and troubleshooting information.

- [Conventions Used, on page xlv](#)

Conventions Used

The following tables describe the conventions used throughout this documentation.

Notice Type	Description
Information Note	Provides information about important features or instructions.
Caution	Alerts you of potential damage to a program, device, or system.

Notice Type	Description
Warning	Alerts you of potential personal injury or fatality. May also alert you of potential electrical hazards.

Typeface Conventions	Description
Text represented as a <i>screen display</i>	This typeface represents displays that appear on your terminal screen, for example: <i>Login:</i>
Text represented as commands	This typeface represents commands that you enter, for example: show ip access-list This document always gives the full form of a command in lowercase letters. Commands are not case sensitive.
Text represented as a command variable	This typeface represents a variable that is part of a command, for example: show card <i>slot_number</i> <i>slot_number</i> is a variable representing the desired chassis slot number.
Text represented as menu or sub-menu names	This typeface represents menus and sub-menus that you access within a software application, for example: Click the File menu, then click New



CHAPTER 1

Overview

The Evolved Packet Core (EPC) network is evolving and moving toward Control User Plane Separation (CUPS) based architecture where User Plane and Control Plane are separate nodes for P-GW, S-GW, and TDF products. The User Plane and Control Plane combined together provide functionality of a node for other elements in the EPC network. However, keeping it separate has numerous advantages from the network point of view – support different scaling for Control Plane and User Plane, support more capacity on per session level in User Plane, and so on.

This chapter highlights high-level details, call flows, and configurations related to Control Plane implementation for P-GW, S-GW, and SAEGW products.

- [Product Description, on page 1](#)
- [Supported Features and Functionality, on page 2](#)
- [How It Works, on page 18](#)

Product Description

The existing non-CUPS SAEGW service is reused to provide Control Plane functionality for Sxa, Sxb, and Sxab (combined Sxa and Sxb) interfaces. The differences are:

1. The respective EGTPC services of P-GW and S-GW are not associated with GTP-U service.
2. Sx service, which is the interface toward the User Plane, is associated with the SAEGW service.
3. The GTP-U service is associated with an SAEGW service for receiving GTP-U packets (for Router Advertisement/Router Solicitation or any data buffering required at Control Plane).

Sx Interface

As part of the CUPS architecture, the Sx interface is used for communication between Control Plane and User Plane.

At Control Plane, the SAE-GW service is associated with Sx service for communication with the User Plane. Also, a single Sx service is capable of handling all interfaces like Sxa, Sxb, and Sxab, which is required for Pure-S, Pure-P and Collapsed PDN respectively.

Supported Features and Functionality

3GPP ULI Enhanced Reporting Support

This feature enhancement covers ULI-related gaps in P-GW and GGSN as per 3GPP standards.

S4SGSN reports ULI to the P-GW through S-GW. P-GW determines the changes in the ULI with previously received ULI. If P-GW detects any change and the change request is from the PCRF as an event trigger, then the P-GW reports the ULI to the PCRF.

SGSN reports ULI to the GGSN. GGSN determines the changes in the ULI with previously received ULI. If GGSN detects any change and the change request is from the PCRF as an event trigger, then the GGSN reports the ULI to the PCRF. This feature also supports the detection of the change in RAI received as part of the ULI field at GGSN.

For more information on 3GPP ULI Reporting Support Enhancement, refer the *3GPP ULI Reporting Support Enhanced* section in the *StarOS P-GW Administration Guide*.

AAA Server Group

The AAA Server Group feature is used to create and manage the Diameter/RADIUS server groups within the context or system. The AAA server group facilitates management of group (list) of servers at per subscriber/APN/realm-level for AAA functionality.



Note The AAA Server Group is an existing feature that is supported in non-CUPS architecture. With this release, the feature is qualified in CUPS architecture.

For additional information about CLI configurations related to AAA server group, refer the *AAA Server Group Configuration Mode Commands* chapter in the *Command Line Interface Reference*.

APN Configuration Support



Note Revision history details are not provided for features introduced before release 21.24.

Revision Details	Release
First introduced	Pre 21.24

The CLI commands **radius-group**, **cc-home behaviour 0x10 profile 2** and **mediation-device** are qualified and validated in the CUPS architecture to support APN configuration.

radius-group

Under this functionality validation the CUPS architecture supports 800 Radius Server Groups each group configured with RADIUS Authentication and Accounting server.

cc-home { behavior *bits* | profile *index* }

Configures the home subscriber charging characteristics (CC) used by the GGSN when those from the SGSN will not be accepted. The values configured in the CLI are taken into precedence by CUPS SAEGW service and populated appropriately in the GTPP CDR records.

NOTES:

- **behavior *bits***: Specifies the behavior bit for the home subscriber charging characteristic. *bits* can be configured to any unique bit from 001H to FFFH (0001 to 1111 1111 1111 bin) where the least-significant bit corresponds to B1 and the most-significant bit corresponds to B12.
- **profile *index***: Specifies the profile index for the home subscriber charging characteristic. *index* can be configured to any integer value between 0 and 15. Default: 8
- For more information, refer to the **cc-home** command under *APN Configuration Mode Commands* chapter in the *Command Line Interface Reference A-B* document

mediation-device [context-name *context_name*] [delay-GTP-response] [no-early-PDUs] [no interims] +

This command and all associated sub section CLIs are supported in CUPS. This CLI enables use of **mediation device** and all associated configuration that can be used for a given APN by CUPS SAEGW service.

NOTES:

- **context-name *context_name***: Configures the mediation VPN context for this APN as an alphanumeric string of 1 through 79 characters that is case sensitive. If not specified, the mediation context is the same as the destination context of the subscriber. Default: The subscribers destination context.
- **delay-GTP-response**: When enabled, delays the CPC response until an Accounting Start response is received from the mediation device. Default: Disabled.
- **no-early-pdus**: Specifies that the system delays PDUs from the MS until a response to the GGSN accounting start request is received from the mediation device. The PDUs are queued, not discarded. Default: Disabled.
- **no-interim**: Disables sending interims to the mediation server. Default: Disabled.
- For more information, refer to the **mediation-device** command under *APN Configuration Mode Commands* chapter in the *Command Line Interface Reference A-B* document

Asynchronous Core Transfer Support for egtpinmgr

Asynchronous core transfer support for egtpinmgr has been added in CUPS to optimize outage time during an egtpinmgr restart.

Previously, when the egtpinmgr restarted, the recovery process began only after a core dump file was created and transferred. However, the time taken to transfer the core file was significant. The outage time during an egtpinmgr restart was equal to the egtpinmgr recovery time plus the core file transfer time.

Support for Asynchronous Core Transfer has been added in CUPS to include the egtpinmgr during the recovery process. Now, recovery begins when the egtpinmgr process crashes without waiting for the kernel to complete a core dump file transfer and release its resources. As a result, the outage time during an egtpinmgr restart is equal to the egtpinmgr recovery time only.

With this enhancement, outage time during an egtpinmgr restart is reduced. The outage time consists only of the time required to recover the egtpinmgr. The time taken to create and transfer the core file no longer contributes to the outage time.



Note The Asynchronous Core Transfer Support for egtpinmgr is an existing feature that is supported in non-CUPS architecture. With this release, the feature is qualified in CUPS architecture.

Bit Rate Mapping Support

P-GW converts the bit rate value that it receives from PCRF from bps to kbps. This conversion may lead to truncation of fractional value to nearest integer (floor) value and lead to loss of information. 3GPP suggested that if the conversion from bps to kbps leads to a fractional value, then it should be rounded up to the nearest integer value (ceil) value and sent to the access side.



Note Design changes are done to ensure rounded down (floor) value from bps to kbps is sent on the PFCP interface.

Standards Compliance

The bit rate mapping feature complies with 3GPP TS 29.274 release 12.

Configuring the Bit Rate Mapping Feature

To configure the rounded up (ceil) value for bit rate from bps to kbps in APN-AMBR, GBR, and MBR on P-GW, perform the following steps:

```
configure
  context context_name
    pgw-service service_name
      [ no ] egtp bitrates-rounded-down-kbps
    end
```

To configure the rounded down (floor) value for bit rate from bps to kbps in APN-AMBR, GBR, and MBR on P-GW, perform the following steps:

```
configure
  context context_name
    pgw-service service_name
      egtp bitrates-rounded-down-kbps
    end
```

New Behavior in CUPS

By default, the rounded up value of bit rate in kbps for APN-AMBR, MBR, and GBR will be sent on the Sx and GTP interfaces. To enable the rounding down behavior, CLI must be configured.

Call Log Summary

Call Log Summary (CLS) is a mechanism by which subscriber activities like Session Creation or Deletion, Bearer Creation or Update or Deletion is reported to external server.

When CLS is enabled on the CUPS CP node, it generates events records. These records can be stored in chassis hard disk in CSV file format. The files can be stored in .gz compressed format as well. These files are later SFTPed to external server for further analysis from network operator in order to maintain and troubleshoot the network.

In CUPS mode the feature can be enabled in Control Plane node, where SGW, PGW records are generated depending upon SAEGW call type.



Note For more details on Call Log Summary (CLS), refer to the StarOS SAEGW Administration Guide.

Charging Data Records to HDD

A Charging Data Record (CDR) is a formatted collection of information about a chargeable event. The GTPP accounting CDRs that are generated are sent to an external node for storage. The CDRs are written to files in formats supported by the external node and stored on the hard disk (HDD). From the HDD, CDR files can be pushed or pulled using FTP or SFTP protocols.



Note It is strongly recommended that you do not use the system directories created by StarOS under `/hd-raid/records/` for deployment use cases such as backups. If such directories are used, this could impact the normal functioning of the product.

CDR is an existing feature that is supported in the non-CUPS architecture, and qualified in the CUPS architecture. For additional information, see the *HDD Storage* chapter in the *GTPP Interface Administration and Reference*.

GTP-C Path Failure Enhancements and Improved Debugging Tools

In CUPS architecture, enhancements have been added to optimize GTP-C path failure functionality, and to improve the debug capability of the system for GTP-C path failure problems. These features will help Operators and Engineers to debug different aspects of the system that will help in identifying the root cause of GTP-C path failures in the network. These enhancements affect path failure detection via the S5, S8, S2b, and S2a interfaces.

The following enhancements are added in CUPS as part of this feature:

- The node can be configured so that it does not detect a path failure if a low restart counter is received due to incorrect or spurious messages. This prevents call loss. The option to disable path failure due to Echo Request/Response and Control Message Request/Response messages is also available so that call loss is prevented in the event of a false path failure detection.
- More granularity has been added to GTP-C path failure statistics so that the root cause of issues in the network can be diagnosed more quickly.

- A path failure history for the last five path failures per peer is available to assist in debugging path failures in the network.
- Seamless path failure handling is implemented so that call loss is avoided during redundancy events.



Note The GTP-C Path Failure Enhancements and Improved Debugging Tools is an existing feature that is supported in non-CUPS architecture. With this release, the feature is qualified in CUPS architecture. For additional information, refer the *GTP-C Path Failure Enhancements and Improved Debugging Tools* section in the *P-GW Administration Guide*.

GTPP Suppress-CDR No Zero Volume

This feature allows suppression of CDRs with zero byte data count, so that the OCG node is not overloaded with a flood of CDRs. The CDRs can be categorized as follows:

- Final-cdrs: These CDRs are generated at the end of a context.
- Internal-trigger-cdrs: These CDRs are generated due to internal triggers such as volume limit, time limit, tariff change, or user-generated interims through the CLI commands.
- External-trigger-cdrs: These CDRs are generated due to external triggers such as QoS Change, RAT change and so on. All triggers which are not considered as final-cdrs or internal-trigger-cdrs are considered as external-trigger-cdrs.

The customers can select the CDRs they want to suppress.

The CLI command mentioned below helps suppress CDRs on different CDR triggers supported in CUPS:

- **[default | no] gtp suppress-cdrs zero-volume { external-trigger-cdr | final-cdr | internal-trigger-cdr }**

Lawful Intercept

The Cisco Lawful Intercept feature is supported on CUPS. Lawful Intercept is a licensed-enabled, standards-based feature that provides telecommunications service providers with a mechanism to assist law enforcement agencies in monitoring suspicious individuals for potential illegal activity.

For additional information and/or to obtain documentation for Lawful Intercept feature, contact your Cisco Account representative.

Location Based DNS and PCSCF IP Address Selection

Location-based DNS and P-CSCF Selection provides an option to the operator to manage the DNS server address and P-CSCF IP address according to location information.

P-GW gathers the DNS server address and P-CSCF IP address information by Tracking Area Identifier (TAI), which is achieved through the TAC-based Virtual APN (VAPN) selection.

When UE sends the PCO request in session creation, P-GW selects the Virtual APN (VAPN) with the received location information. The selected VAPN (with DNS server address and P-CSCF IP address configured in it) with PCO IE is sent in the Create session response.

Following are the CLI commands for enabling the Location-based DNS and PCSCF IP address selection:

Command	Description
Tracking-area-code-range from <start value> to <end value>	Provides the tracking area code range, starting from 0 through 65536. The end value is always greater than the start value.
P-cscf priority <priority> ip/ipv6 <IPv4/IPv6 address>	Specifies the priority for P-CSCF address for the APN. Address_priority is an integer 1–3. One is the maximum priority. IPv4_address is in IPv4 dotted-decimal notation. IPv6_address is in IPv6 colon-separated-hexadecimal notation.
Show apn name <APN Name>	To show PCSCF IP address at APN
dns primary <IPv4 address> Dns secondary <IPv4 address> ipv6 dns primary <IPv6 address> ipv6 dns secondary <IPv6 address>	Primary: Configures the primary DNS server for the APN. Secondary: Configures the secondary DNS server for the APN. Only one secondary DNS server is configurable. Address: Configures the IP address of the DNS server expressed in IPv4 dotted-decimal notation. Default: primary = 0.0.0.0, secondary = 0.0.0.0 dns_address: Specifies the IP address of the DNS server to remove, expressed in IPv4 dotted-decimal notation.
Show apn name <APN Name>	To show DNS IP address at APN

MPRA Support

P-GW supports negotiation of Multiple-Presence Reporting Area feature in Feature-List-ID 2 over Gx interface with PCRF. The CNO-ULI feature works only when the P-GW and/or the PCRF doesn't support Multiple-PRA and both P-GW and PCRF support CNO-ULI.

For Multiple-PRA feature support during the lifetime of the IP-CAN session, P-GW handles the change of UE Presence in Reporting Areas request from PCRF in PRA-Install AVP including the Presence-Reporting-Area-Information AVPs. Each AVP contains the Presence Reporting Area Identifier within the Presence-Reporting-Area-Identifier AVP

For more information on Presence Reporting Area (PRA) and Multiple PRA, refer the *Presence Reporting Area* chapter in the *StarOS P-GW Administration Guide*.

No udp-checksum Support

This feature supports **no udp-checksum** CLI command for CUPS under GTPU service where **udp-checksum** is disabled in the outer GTPU header for the downlink subscriber packet. When downlink packet arrives from internet, the GTPU header is added on top of the packet and is sent to the access side. The "checksum" value is zero in the outer UDP layer of this packet enabling optimization and therefore, improving the performance throughput.

Use the following configuration to enable the feature.

```

configure
  context context_name
    gtpu-service gtpu_service_name
    [ no ] udp-checksum
  end

```

Show Commands and Outputs

This section provides information about the show CLI commands available in support of the feature.

Use the following command to determine if **GTPU UDP Checksum** is enabled or disabled.

- **show gtpu-service all**—Displays all GTPU services.
- **show gtpu-service name service_name**—Displays information for the specific GTPU service name.

Optimization for egtpinmgr Recovery

Previously, when the egtpinmgr task restarted, it took a significant amount of time for it to recover. As a result, the outage time when the SAEGW were unable to accept any new calls during egtpinmgr recovery was high.

The software has been enhanced to optimize the recovery outage window in the event of an egtpinmgr task restart; this has been achieved by optimizing the internal algorithms of egtpinmgr recovery and the data structures required. In addition, recovery time now is dependent only on the number of unique IMSIs and not on the number of sessions for an IMSI.



Note The Optimization for egtpinmgr Recovery is an existing feature that is supported in non-CUPS architecture. With this release, the feature is qualified in CUPS architecture.

QUIC IETF Implementation

In the current framework, Deep Packet Inspection (DPI) is done for every packet in a flow when it reaches the plugin. The DPI is done by analyzing the packets and extracting deterministic patterns. The DPI is done in-order to detect the application and to classify its subtype. Plugin excludes the flow after the DPI. The flow is offloaded after the detection. As part of QUIC IETF, the initial QUIC handshake packets (Client/Server Hello) are encrypted over the network. Hence, there are no deterministic patterns available for detection of the application. Support is added in p2p plugin to decrypt and obtain the SNI (Server Name Indication) for detection.

Configuring QUIC IETF

Use the following configuration to enable or disable the QUIC IETF decryption.

```

configure
  active-charging service acs_service_name
    p2p-detection debug-param protocol-param p2p_quic_ietf_decrypt 1
  end

```



Note By default, the CLI is disabled and there's minimal impact on the performance due to TLS decryption.

Quota Hold Time Support

Quota-Hold-Time (QHT) is an inactivity time duration, after which the Gateway(Diameter client) returns the Charging-Bucket with its usage and reaches a clean-state.

The QHT value is provided by the OCS per Category - Multiple-Services-Credit-Control (MSCC), or the gateway provides an option to configure the default value of the QHT - for enabling the default QHT value for the MSCCs for which the OCS has not provided any QHT AVP.

The QHT timer runs per MSCC bucket. If the QHT timer expires without a packet during run-time, then the usage is reported with the Reporting-Reason: QHT as per 3GPP specification.

The QHT value received in the CP from the OCS, is sent in the "Quota Holding Time" IE defined in the CUPS specification 3GPP TS 29.244. Also along with provisioning the Quota-Holding-Time IE to the UP, the Reporting-Triggers will be sent with the bit corresponding to Quota-Holding-Time SET, so that on QHT expiry the reporting takes place.

The UP on receiving the Quota-Holding-Time IE along with the QHT Reporting-Triggers enabled, starts the timer per URR to monitor the inactivity period. Once the inactivity period exceeds the QHT time, the Usage-Reporting is initiated from the UP for the Trigger : Quota-Holding-Time.

The CP on receiving the QHT event from UP, triggers the QHT reporting to the OCS after updating the usage in the MSCC bucket.

Configuring Quota Hold Time

Use the following configuration to enable Quota Hold Time in CUPS:

```
configure
  require active-charging
  active-charging service service_name
  credit-control group group_name
  quota-hold-time timer_value
end
```

NOTES:

- **quota-hold-time:** configures the inactivity duration after which the charging bucket reports its usage and have a clean state.

Limitation

The QHT (inactivity-timer) usually is a larger value compared to the flow-idle timer. If the flow-idle timer is larger than QHT, then there is a possibility for the flows present even after the QHT expiry, and is processed by VPP as per the NoQuota Pending-Traffic-Treatment configuration.

S-GW Paging Enhancement

S-GW Paging includes the following scenarios:

Scenario 1: S-GW sends a Downlink Data Notification (DDN) message to the MME/S4-SGSN nodes. MME/S4-SGSN responds to the S-GW with a DDN Ack message. While waiting for the DDN Ack message from the MME/S4-SGSN, if the S-GW receives a high priority downlink data, it does not resend a DDN to the MME/S4-SGSN.

Scenario 2: If a DDN is sent to an MME/S4-SGSN and TAU/RAU MBR is received from another MME/S4-SGSN, S-GW doesn't send DDN.

Scenario 3: DDN is sent to an MME/S4-SGSN and DDN Ack with Cause #110 is received. DDN Ack with cause 110 is treated as DDN failure and standard DDN failure action procedure is initiated.

To handle these scenarios, the following two enhancements are added to the DDN functionality in CUPS architecture:

- High Priority DDN at S-GW
- MBR-DDN Collision Handling

These enhancements support the following:

- Higher priority DDN on S-GW and SAEGW, which helps MME/S4-SGSN to prioritize paging.
- Enhanced paging KPI and VoLTE services.
- DDN message and mobility procedure so that DDN isn't lost.
- MBR guard timer, which is started when DDN Ack with temporary HO is received. A CLI command **ddn temp-ho-rejection mbr-guard-timer** has been introduced to enable the guard timer to wait for MBR once the DDN Ack with cause #110 (Temporary Handover In Progress) is received.
- TAU/RAU with control node change triggered DDNs.

In addition, to be compliant with 3GPP standards, support has been enhanced for Downlink Data Notification message and Mobility procedures. As a result, DDN message and downlink data which triggers DDN is not lost. This helps improve paging KPI and VoLTE success rates in scenarios where DDN is initiated because of SIP invite data.



Note For information on Downlink Data Notification (DDN) messages with support for DDN Delay and DDN Throttling, refer the *SAEGW Idle Buffering with DDN Delay and DDN Throttling* chapter in this guide.

For more information on how S-GW Paging Enhancement feature works, configuration, monitoring and troubleshooting, refer the *S-GW Paging Enhancements* chapter in the *StarOS S-GW Administration Guide*.

Session Recovery and ICSR at Control Plane

The Session Recovery (SR) feature provides seamless failover and reconstruction of subscriber session information in the event of a hardware or software fault within the system preventing a fully connected user session from being disconnected.

The Interchassis Session Recovery (ICSR) feature provides the highest possible availability for continuous call processing without interrupting subscriber services. ICSR allows the operator to configure gateways for redundancy purposes. In the event of a gateway failure, ICSR allows sessions to be transparently routed around the failure, thus maintaining the user experience. ICSR also preserves session information and state.

The existing non-CUPS framework is extended to support CUPS Control Plane SR and ICSR. At Control Plane, complete session/PDN state is recovered in case of SR/ICSR.

For more information on SR and ICSR, refer the *Session Recovery* and *Interchassis Session Recovery* feature chapter in the *VPC-SI System Administration Guide*.



Important In this release, if ICSR switchover is performed on Control Plane (CP), then the **show sx peers** CLI command doesn't show any associated peers on new active chassis. However, there's no impact to the functionality.

SRP over IPsec on the Active CP and Standby CP

IPSec is a suite of protocols that interact with one another to provide secure private communications across IP networks. These protocols allow the system to establish and maintain secure tunnels with peer security gateways. IPSec provides confidentiality, data integrity, access control, and data source authentication to IP datagrams.

The CUPS architecture leverages the IPSec protocol to encrypt the packets sent over the Interchassis Session Recovery (ICSR) connection between the active and standby CPs. This encryption is done by defining an access-list to match all traffic between Service Redundancy Protocol (SRP) peers and associating it with a crypto map. This crypto map is used to establish Security Association between IPSec peers residing in CPs.

For more information on IPSec, its features/functionality, and applicable CLI configurations, refer the StarOS *IPSec Reference*.

Example Configurations

1. IKEv1 – Tunnel Mode

The following is an example configuration of IKEv1 in tunnel mode.

```
ACL:
  ip access-list acl_name
    permit ip host ipv4_address host ipv4_address
Transform Set:
  crypto ipsec transform-set transform_name esp hmac sha1-96 cipher
  aes-cbc-128
  mode tunnel
Policy:
  ikev1 policy priority
    encryption aes-cbc-256
    group 5
    lifetime time
Crypto-Map:
  crypto map map_name ipsec-ikev1
    match address acl_name
    set peer ipv4_address
    set ikev1 preshared-key ikev1_key
    set pfs group2
    set security-association lifetime seconds seconds
    set transform-set transform_name
Interface Association:
  interface interface_name
    ip address ipv4address_range
```

```

    crypto-map map_name
    interface interface_name loopback
        ip address address_range
    !
    ip route ipv4address_range interface_name

```

2. IKEv1 – Transport Mode

The following is an example configuration of IKEv1 in transport mode.

ACL:

```

ip access-list acl_name
    permit ip host ipv4_address host ipv4_address

```

Transform Set:

```

crypto ipsec transform-set transform_name esp hmac sha1-96 cipher
aes-cbc-128
    mode transport

```

Policy:

```

ikev1 policy priority
    encryption aes-cbc-256
    group 5
    lifetime time

```

Crypto-Map:

```

crypto map map_name ipsec-ikev1
    match address acl_name
    set peer ipv4_address
    set ikev1 preshared-key ikev1_key
    set pfs group2
    set security-association lifetime seconds seconds
    set transform-set transform_name

```

Interface Association:

```

interface interface_name
    ip address ipv4address_range
!
interface interface_name loopback
    ip address address_range
    crypto-map map_name
!
ip route ipv4address_range interface_name

```



Note IKEv1 - Transport mode with Authentication Header (AH) protocol isn't supported. Only Tunnel mode is supported. Encapsulating Security Payload (ESP) is recommended as ESP performs both Authentication and Encryption.

3. IKEv2 – IPv4

The following is an example configuration of IKEv1 for IPv4 address.

ACL:

```

ip access-list acl_name
    permit ip host ipv4_address host ipv4_address

```

Transform Set:

```

ipsec transform-set transform_name
!

```

```

ikev2-ikesa transform-set transform_name
Crypto-Map:
crypto map map_name ikev2-ipv4
    match address name
    authentication local pre-shared-key key key_name
    authentication remote pre-shared-key key key_name
    ikev2-ikesa max-retransmission mt_value
    ikev2-ikesa retransmission-timeout rt_seconds
    ikev2-ikesa transform-set list name
    payload payload match ipv4
    ipsec transform-set list name
    peer ipv4_address
    ikev2-ikesa policy error-notification
Interface Association:
    interface interface_name
        ip address ipv4address_range
        crypto-map map_name
    !
    interface interface_name loopback
        ip address ipv4address_range
    !
    ip route ipv4address_range interface_name

```

4. IKEv2 – IPv6

The following is an example configuration of IKEv1 for IPv6 address.

```

ACL:
    ip access-list acl_name
        permit ip host ipv6_address host ipv6_address
Transform Set:
ipsec transform-set transform_name
!
ikev2-ikesa transform-set transform_name
Crypto-Map:
crypto map map_name ikev2-ipv6
    match address name
    authentication local pre-shared-key key key_name
    authentication remote pre-shared-key key key_name
    ikev2-ikesa transform-set list name
    payload payload match ipv6
    ipsec transform-set list name
!
    peer ipv6_address
Interface Association:
    interface interface_name
        ipv6 address ipv6_address
        crypto-map map_name
    !
    interface interface_name loopback
        ipv6 address ipv6_address
    !
    ipv6 route ipv6address_range interface_name

```

NOTES:

- MTU must be configured to maximum limit of loopback interface. For example:

```
configure
context SRP
ip path-mtu-max 1300
```

- IKEv1 - Transport mode with Authentication Header (AH) protocol isn't supported. Only Tunnel mode is supported. Encapsulating Security Payload (ESP) is recommended as ESP performs both Authentication and Encryption.
- Auto-delete Existing IKEv1/IKEv2 ACL Tunnels: Critical (Authentication, Encryption, Hash, and DH group) parameter changes inside the IKEv1 policy deletes all the established tunnels within that context.

Refer *Auto-delete Existing IKEv1/IKEv2 ACL Tunnels* section in the *StarOS IPSec Reference* for more information.

SRVCC PS to CS Handover Indication and the QoS Class Index IMS Media Configuration Support

This feature notifies the PCRF about the cause for PCC rule deactivation on Voice bearer deletion. This notification helps the PCRF to take further action appropriately.

This feature ensures the compliance for SRVCC. This feature also supports the PS-to-CS handover indication after release of the voice bearers.

SRVCC service for LTE lets a single radio User Equipment (UE) accessing IMS-anchored voice call services to switch from LTE network to Circuit Switched domain. The UE switches the network while it can transmit or receive on only one of the access networks then. The SRVCC service removes the need for a UE to have multiple Radio Access Technology (RAT) capabilities.

After handing over the PS sessions to the target, the source MME removes the Voice Bearers (VB). The MME removes the VB by deactivating the voice bearers. The MME bars the VB towards S-GW/P-GW and sets the VB flag of Bearer Flags IE in the Delete Bearer Command message (TS 29.274 v9.5.0).

If the IP-CAN bearer termination happens due to PS to CS handover. The PCEF reports the related PCC rules for this IP-CAN bearer by including the Rule-Failure-Code AVP set to the value: PS_TO_CS_HANDOVER (TS 29.212 v10.2.0 and TS 23.203 v10.3.0).

Support for new AVP PS-to-CS-Session-Continuity (added in 3GPP Release 11) inside Charging Rule Install indicates the bearer support for PS to CS continuity.

QCI IMS-Media Configuration Support

Specifies the QoS Class Index (QCI) value to mark the IMS media bearers for preferential treatment during session recovery and ICSR switchover.

Mode

Exec > Global Configuration > Context Configuration > APN Configuration

configure > context <context_name> **apn** <apn_name>

Entering the above command sequence results in the following prompt:

```
[context_name]host_name(config-apn)#
```

Syntax

qci value_bytes ims-media

no qci value_bytes ims-media

**Note**

- *no*: Disables this IMS QCI feature.
- *ims-media*: Marks bearers classified as IMS media for preferential treatment during session recovery and ICSR switchover.
- *value_bytes*: Specifies the QCI value an integer from 1 through 254.

Usage Guidelines

Use this command to specify the QCI value to be used to mark bearers classified as IMS media for preferential treatment during session recovery and ICSR switchover.

The following prerequisites apply to the implementation of this feature:

- A dedicated APN must be reserved for VoLTE traffic.
- A call connected to this APN will not be classified as Active VoLTE unless there is a dedicated bearer matching the VoLTE-configured QCI.
- Preferential treatment would be given to only those calls which are active VoLTE.
- A GGSN call connected to this APN will not be classified as Active VoLTE unless there is network initiated bearer matching the VoLTE-configured QCI.
- VoLTE marking is preserved across a Gn-Gp handoff.

When this feature is enabled via a CLI command, the actions are taken:

- During bearer creation
 - New bearer QCI is matched against APN configuration.
 - If the QCI matches an APN configuration, the bearer is marked for preferential treatment.
 - Flow_entries are modified with this information (if this is first VoLTE bearer).
 - Egtpu_session is updated with the VoLTE tag during a rx_setup request.
 - An indication message informs ECS about the VoLTE tagging.
- During bearer deletion
 - Flow_entry is updated with VoLTE information if this is the last VoLTE bearer.
 - ECS is informed of the deletion via an indication message.

The following command enables preferential treatment for IMS bearers with a QCI of 9:

qci 9 ims-media

Support for ip hide-service-address CLI Command

The **ip hide-service-address** CLI command is supported in CUPS.

When enabled, this CLI renders the IP address of the GGSN unreachable from mobile stations (MSs) using this APN. This command is configured on a per-APN basis.

Use the following configuration to enable or disable the feature.

```
configure
context context_name
  apn apn_name
    [ default | no ] ip hide-service-address
  end
```

- **default**: Does not allow the mobile station to reach the GGSN IP address using this APN.
- **no**: Allows the mobile station to reach the GGSN IP address using this APN.
- Use this command to prevent subscribers from using traceroute to discover the network addresses that are in the public domain and configured on services.

Support for regardless-of-other-triggers CLI Command

This feature supports **regardless-of-other-triggers** option in CLI for CUPS. **regardless-of-other-triggers** option enables eG-CDR or P-GW-CDR generation at the fixed time interval irrespective of any other eG-CDR or P-GW-CDR triggers that may occur in between. Therefore, when you enable this option although other CDR triggers occur, the Time Limit CDR gets triggered dynamically at every *interval* in seconds, that is, the Time Threshold calculation is based on the sum of the last threshold time and the interval. This option supports session recovery and ICSR.

Use the following configuration to enable the feature.

```
configure
active-charging service service_name
  rulebase rulebase_name
    egcdr threshold interval interval regardless-of-other-triggers
  end
```

The following steps are carried out when a new call comes in:

- When you enable, **regardless-of-other-triggers** even if any other usage report triggers in between, timer will not be reset, and the session usage report for the time threshold occurs for every interval time configured.

Show Commands and Outputs

This section provides information about the show CLI commands available in support of the feature.

- **show active-charging rulebase name name**
- **show active-charging rulebase all**

The output of these CLI commands includes the following fields to support this feature.

- Interval Threshold: <seconds> (secs) Regardless of Other Triggers

TFT Suppression for Default Bearer

Feature Description

TFT Suppression for default bearer is supported in the UPC CUPS architecture. Following CLI commands are added in support of this feature.

- **policy-control update-default-bearer**
- **no tft-notify-ue-def-bearer**

The preceding CLI commands are used to bind all the predefined rules received from PCRF without QoS and ARP or with the same QoS and ARP as that of the default bearer, to the default bearer.



Important This CLI is applicable to all the rulebases in the chassis configuration. If the rulebase is changed to some other rulebase in the interim period or anytime later, this CLI will continue to apply to the current new rulebase too.

Configuring TFT Suppression

Configuring TFT Suppression in Default Bearer for Predefined Rules

Use the following commands to configure TFT Suppression for default bearers.

```
configure
  require active-charging
  require active-charging service_name
    [ default | no ] policy-control update-default-bearer
  end
```



Caution Upon executing this CLI command "**no policy-control update-default-bearer**", system crash is likely to occur if the TFT information is not added to the charging-action.

Configuring TFT Suppression in Default Bearer

Use the following commands to configure TFT Suppression for default bearers.

```
configure
  require active-charging
  require active-charging service_name
    rulebase rulebase_name
    [ default | no ] tft-notify-ue-def-bearer
  end
```

**Note**

- **default:** Configures this command with its default setting.
Disables only binding those rules having QoS of default bearer to the default bearer and specifies to not ignore other rules. Rules having respective QoS gets attached to the relevant bearers. Also, TFT updates towards UE (access side) is not suppressed.
- **no:** Enables binding rules having QoS of default bearer to the default bearer and specifies to ignore other rules.
In case no QoS is specified the rule gets attached to default bearer. Also, TFT updates towards UE (access side) is suppressed for default bearer. So only one default-bearer is ever be created.

Zero-byte EDR Suppression

The Zero-byte Event Data Record (EDR) Suppression, a CLI-controlled feature, enables or disables creation of EDRs when there is no data for the flow. A zero-byte EDR is typically possible when two successive EDRs are generated for a flow. The CLI command suppresses the second such EDR for the flow.

Use the following configuration to enable or disable the suppression of zero-byte EDRs.

```
configure
  active-charging service service_name
    rulebase rulebase_name
      [ default | no ] edr suppress-zero-byte-records
    end
```

NOTES:

- **default:** Configures this command with its default setting.
Default: Disabled; same as **no edr suppress-zero-byte-records**
- **no:** Disables the suppression of zero-byte EDRs.
- **edr suppress-zero-byte-records:** Suppresses zero-byte EDRs.
- The “Total zero-byte EDRs suppressed” field in the output of the following CLI command can be used to verify if the zero-byte EDRs are suppressed: **show user-plane-service statistics rulebase name *rulebase_name***.

How It Works

Architecture

User Plane Selection

This section describes how Control Plane selects a particular User Plane for communicating through the Sx interface. The current mechanism uses APN information associated with that PDN, as a key for selecting the User Plane Profile.

Pure-P/ Collapsed PDN

The following flow describes how APN is used as a key for selecting a particular User Plane group.

APN → Associated IP Pool → Associated User Plane Profile ID → User Plane Profile

Every APN is configured with both the associated IPv4 and IPv6 pools. Also, all configured IP pools under APN configuration are associated with the same User Plane group, which contains information related to User Plane IP address and User Plane capabilities. In case Control Plane has to communicate with the same User Plane for all APNs, the IPv4 and IPv6 Pool configuration under APN configuration is not required.

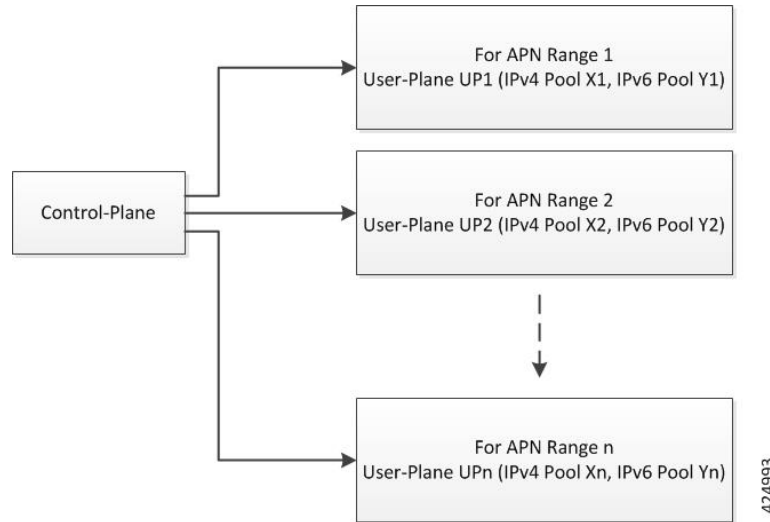

NOTES:

- Control Plane can be configured to communicate with multiple User Planes.
- There is 1-n mapping between the User Plane and APN.
- Multiple APNs can be reached through the same User Plane but for every APN, there can be only one associated User Plane.

Pure-S PDN

The following flow describes how APN is used as key for selecting a particular User Plane group. The APN profile must be configured with associated User Plane group, which contains information related to User Plane IP address and User Plane capabilities.

APN Profile → Associated User Plane Profile ID → User Plane Group

Call Flows

Following is a high-level description of the Control Plane flow in CUPS architecture:

- On receipt of the Create Session Request, the S-GW first makes Sx communication (Sx Session Establishment Request/Response) before sending Create Session Request toward the P-GW.
- On receipt of Create Session Request, the P-GW does the following in sequence:
 - Gx Communication (IP-CAN Session Establishment procedure),

- Sx Communication (Sx Session Establishment Request/Response), followed by
 - Create Session Response toward S-GW.
- On receipt of the Create Session Response from P-GW, the S-GW first makes Sx communication (Sx Session Modification Request/Response) before sending Create Session Response toward the MME.

Initial Attach Procedure (Pure-P)

The following call flow illustrates, at a high-level, the initial attach procedure for a Pure-P PDN.

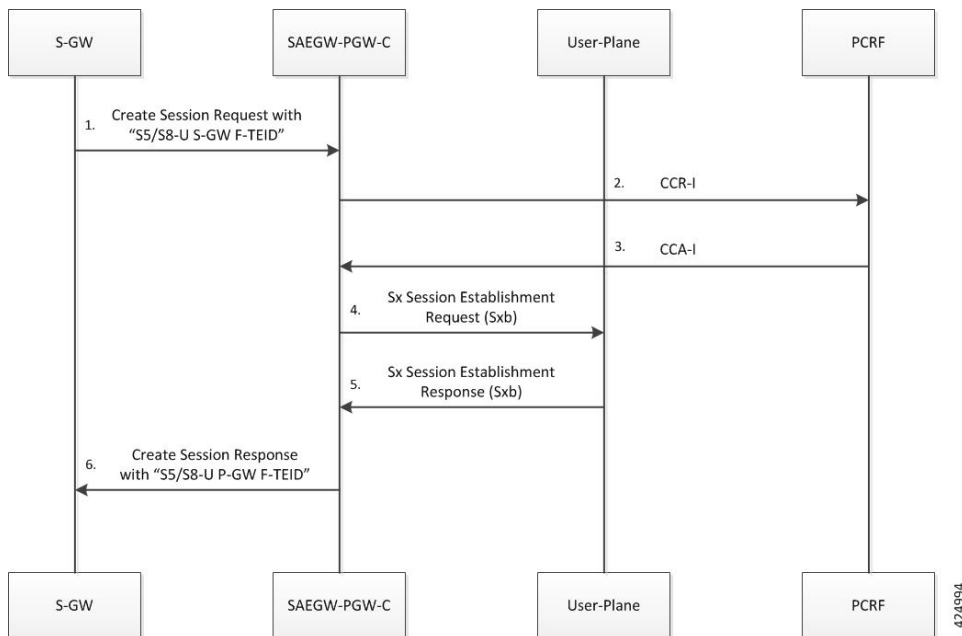

- For CUPS SAEGW Pure-P call, SAEGW-PGW-C does the following:
 - After Gx interaction, performs Gx communication (CCR-I and CCA-I).
 - Performs User Plane selection based on **user-plane-profile** configured with IP Pool (APN associated with IP Pool).
 - Establishes GTP-U session (required for RA/RS, in case of IPv6/IPv4v6 PDN).
 - Performs Sxb interaction with selected User Plane.
- Sx Establishment Request contains the following information:
 - Create PDR/FAR/URR information for Uplink and Downlink data path: For dynamic/pre-defined/static rules.
 - Create PDR/FAR for RA/RS: Required for IPv6/IPv4v6 PDN Type.

**Important**

- Create Uplink PDR is sent with "Outer Header Removal" based on IP address information in "S5/S8-U S-GW F-TEID".
 - Create Downlink FAR is sent with "Outer Header Creation" as "S5/S8-U S-GW F-TEID".
-
- Additionally, Control Plane requests User Plane to allocate F-TEID for P-GW Ingress PDR "S5/S8-U P-GW F-TEID"
3. User Plane provides following information as part of Sx Session Establishment Response:
 - Created PDR: P-GW Ingress PDR "S5/S8-U P-GW F-TEID"
 4. On receipt of Sx Session Establishment Response, the SAEGW-PGW-C sends Create Session Response toward S-GW with "S5/S8-U P-GW F-TEID"

Initial Attach Procedure (Pure-S)

Following call flow illustrates, at a high-level, the initial attach procedure for a Pure-S PDN.

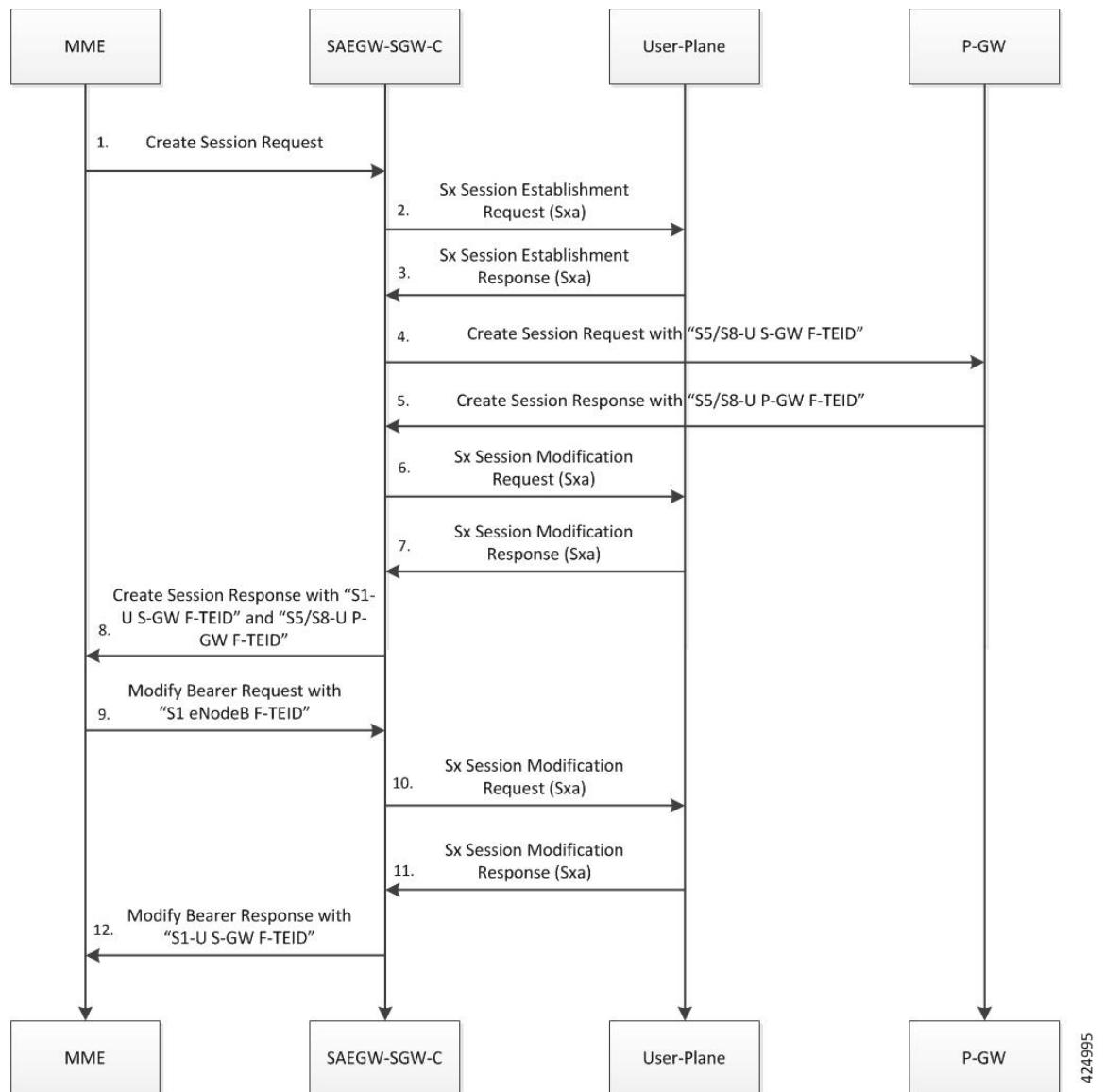

1. For CUPS SAEGW Pure-S call, the SAEGW-SGW-C does the following:
 - Performs User Plane selection based on APN profile.
 - Performs Sxa interaction with selected User Plane.
 - No GTP-U interaction (Note that it is required for non-CUPS behavior).
2. Sx Session Establishment Request contains following information:
 - Create PDR/FAR for S-GW Uplink and Downlink data path.
 - Additionally, Control Plane requests User Plane to allocate F-TEID for:
 - S-GW Ingress PDR "S1-U S-GW F-TEID"
 - S-GW Egress PDR "S5/S8-U S-GW F-TEID"

3. User Plane provides following information as part of Sx Session Establishment Response:
 - Created PDR: S-GW Ingress PDR "S1-U S-GW F-TEID"
 - Created PDR: S-GW Egress PDR "S5/S8-U S-GW F-TEID"
4. On receipt of Sx Session Establishment Response, the SAEGW-SGW-C sends Create Session Request toward P-GW with "S5/S8-U S-GW F-TEID"
5. On receipt of Create Session Response, the SAEGW-SGW-C does the following:
 - Trigger Sx Session Modification Request:
 - To update Uplink FAR with "Outer Header Creation" as "S5/S8-U P-GW F-TEID".
 - To update Downlink PDR with "Outer Header Removal" based on IP address information in "S5/S8-U P-GW F-TEID".
6. On receipt of Sx Session Modification Response, the SAEGW-SGW-C sends Create Session Response toward MME with "S1-U S-GW F-TEID" and "S5/S8-U P-GW F-TEID".
7. On receipt of Modify Bearer Request (MBR), the SAEGW-SGW-C does the following:
 - MBR is consumed by S-GW node. No GTP signaling toward P-GW node.
 - Trigger Sx Session Modification Request:
 - To update Downlink FAR with "Outer Header Creation" as "S1 eNodeB F-TEID".
 - To update Uplink PDR with "Outer Header Removal" based on IP address information in "S1 eNodeB F-TEID".
8. On receipt of Sx Session Modification Response, the SAEGW-SGW-C sends MBR with "S1-U S-GW F-TEID".

Initial Attach Procedure (Collapsed PDN)

The following call flow illustrates, at a high-level, the initial attach procedure for Collapsed PDN.

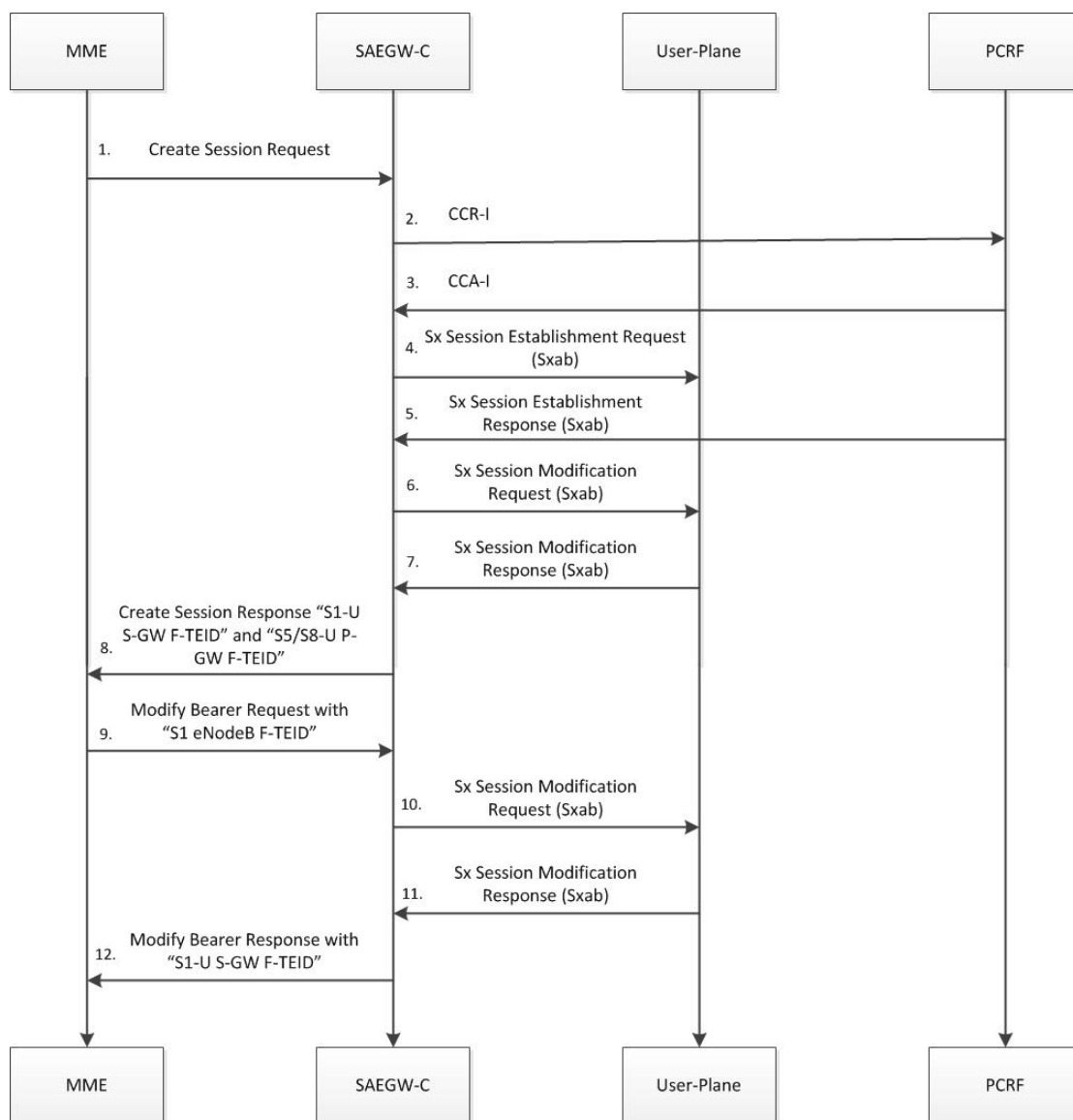

1. For CUPS SAEGW collapsed call, SAEGW-C does the following:

- After Gx interaction, performs Gx communication (CCR-I and CCA-I).
- Performs User Plane selection based on **user-plane-profile** configured with IP Pool (APN associated with IP Pool).
- Establishes GTP-U session (required for RA/RS, in case of IPv6/IPv4v6 PDN).
- Performs Sxab interaction with selected User Plane.

2. Sx Establishment Request contains the following information:

- Create PDR/FAR information for S-GW Uplink and Downlink data path (Sxa Type PDR).
- Create PDR/FAR/URR information for Uplink and Downlink data path (Sxb Type PDR): For dynamic/pre-defined/static rules.

- Create PDR/FAR for RA/RS (Sxb Type PDR): Required for IPv6/IPv4v6 PDN Type.
 - Additionally, Control Plane requests User Plane to allocate F-TEID for:
 - S-GW Ingress "S1-U S-GW F-TEID",
 - S-GW Egress "S5/S8-U S-GW F-TEID", and
 - P-GW Ingress PDR "S5/S8-U P-GW F-TEID"
3. User Plane provides following information as part of Sx Session Establishment Response:
 - Created PDR: S-GW Ingress PDR "S1-U S-GW F-TEID",
 - Created PDR: S-GW Egress PDR "S5/S8-U S-GW F-TEID", and
 - Created PDR: P-GW Ingress PDR "S5/S8-U P-GW F-TEID"
 4. On receipt of successful Sx Session Establishment Response, the Control Plane triggers Sx Modification Request with the following information:
 - To update P-GW (Sxb) "Uplink PDR" with "Outer Header Removal" based on IP address information in "S5/S8-U S-GW F-TEID"
 - To update P-GW (Sxb) "Downlink FAR" with "Outer Header Creation" as "S5/S8-U S-GW F-TEID"
 - To update S-GW (Sxa) "Uplink FAR" with "Outer Header Creation" as "S5/S8-U P-GW F-TEID"
 - To update S-GW (Sxa) "Downlink PDR" with "Outer Header Removal" based on IP address information in "S5/S8-U P-GW F-TEID"
 5. On receipt of Sx Session Modification Response, the SAEGW-C sends Create Session Response toward MME with "S1-U S-GW F-TEID" and "S5/S8-U P-GW F-TEID".
 6. On receipt of Modify Bearer Request (MBR), the SAEGW-C does the following:
 - Trigger Sx Session Modification Request:
 - To update Downlink FAR with "Outer Header Creation" as "S1 eNodeB F-TEID".
 - To update Uplink PDR with "Outer Header Removal" based on IP address information in "S1 eNodeB F-TEID".
 7. On receipt of Sx Session Modification Response, the SAEGW-SGW-C sends MBR with "S1-U S-GW F-TEID".

Detach Procedure (Pure-P): UE Initiated

Following call flow illustrates, at a high-level, the detach procedure for UE initiated Pure-P PDN.

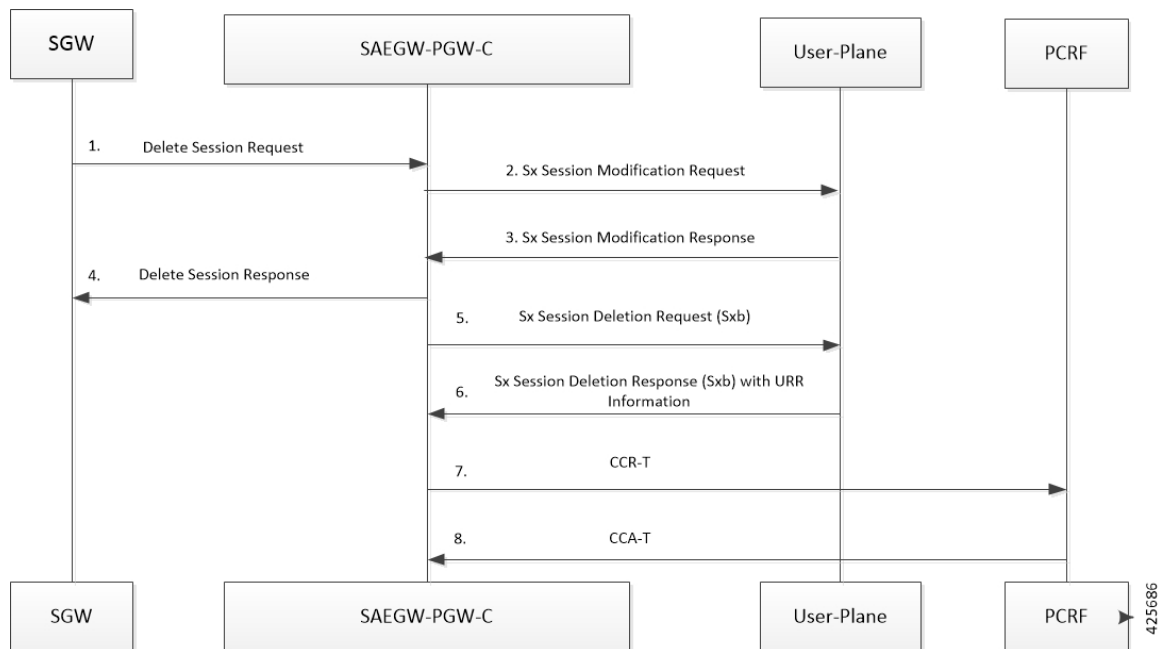

1. On receipt of Delete Session Request , the SAE-GW-C performs Sxab interaction to update FAR with the Apply Action as "DROP" for both Uplink and Downlink data path.
2. On receipt of Sx Session Modification Response, SAE-GW-C sends Delete Session Response towards MME.
3. For CUPS SAEGW Pure-P call, the SAEGW-PGW-C does the following:
 - Removes GTP-U session (required for RA/RS in case of IPv6/IPv4v6 PDN).
 - Performs Sxb interaction with the selected User Plane.
4. On receipt of Sx Session Deletion Response, the SAEGW-PGW-C does the following:
 - Performs Gx communication (CCR-T and CCA-T).
 - Generates CDR (Gz) based on URR information received.

Detach Procedure (Pure-P): Network Initiated

Following call flow illustrates, at a high-level, the detach procedure for network initiated Pure-P PDN.



1. On receipt of the Delete Bearer Request (RAR initiated or by the **clear sub all** CLI, the SAEGW-PGW-C performs Sxb interaction to update FAR with the Apply Action as "DROP" for both Uplink and Downlink data path.
2. On receipt of Sx Session Modification Response, SAEGW-PGW-C sends the Delete Bearer Request toward SGW.
3. For CUPS SAEGW Pure-P call, the SAEGW-PGW-C does the following:
 - Removes GTP-U session (required for RA/RS in case of IPv6/IPv4v6 PDN).
 - Performs Sxb interaction with the selected User Plane.
4. On receipt of Sx Session Deletion Response, the SAEGW-PGW-C does the following:
 - Performs Gx communication (CCR-T and CCA-T).
 - Generates CDR (Gz) based on URR information received.

Detach Procedure (Pure-S): UE Initiated

Following call flow illustrates, at a high-level, the detach procedure for UE initiated Pure-S PDN.

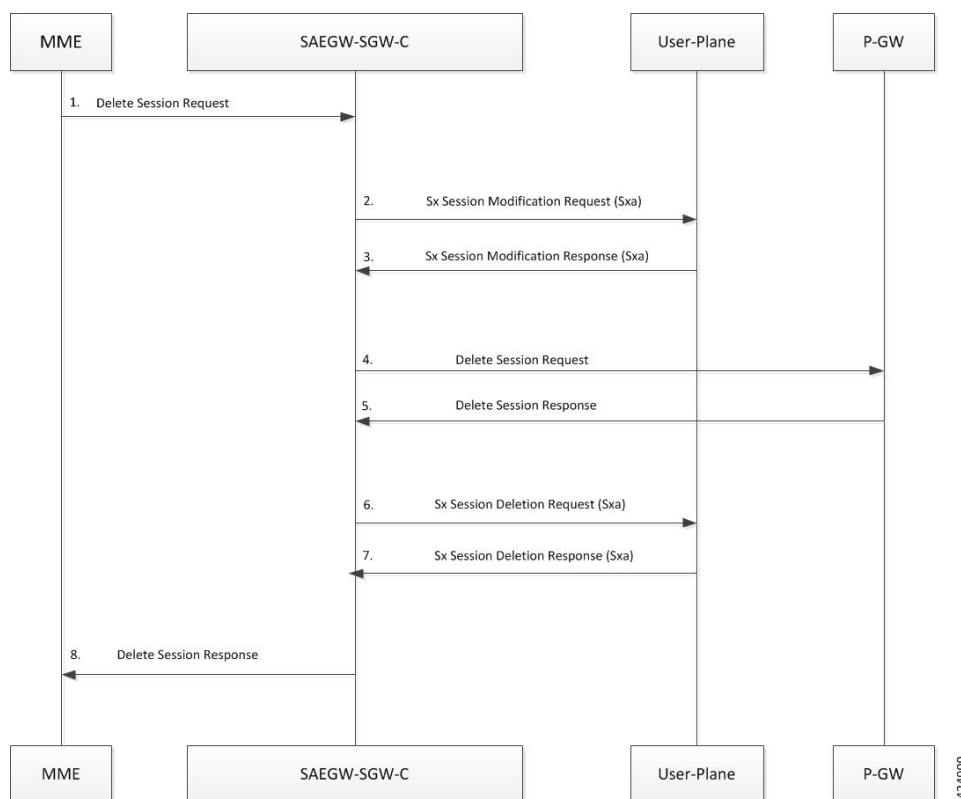

1. On receipt of Delete Session Request, the SAEGW-SGW-C performs Sxa interaction to "Update FAR" with Apply Action as "DROP" for both Uplink and Downlink data path.
2. On receipt of Sx Session Modification Response, the SAEGW-SGW-C sends Delete Session Request toward the P-GW.
3. On receipt of Delete Session Response, the SAEGW-SGW-C performs Sxa interaction to delete Sx session.
4. On receipt of Sx Session Deletion Response, the SAEGW-SGW-C sends Delete Session Response toward the MME.

Detach Procedure (Pure-S): Network Initiated

Following call flow illustrates, at a high-level, the detach procedure for network initiated Pure-S PDN.

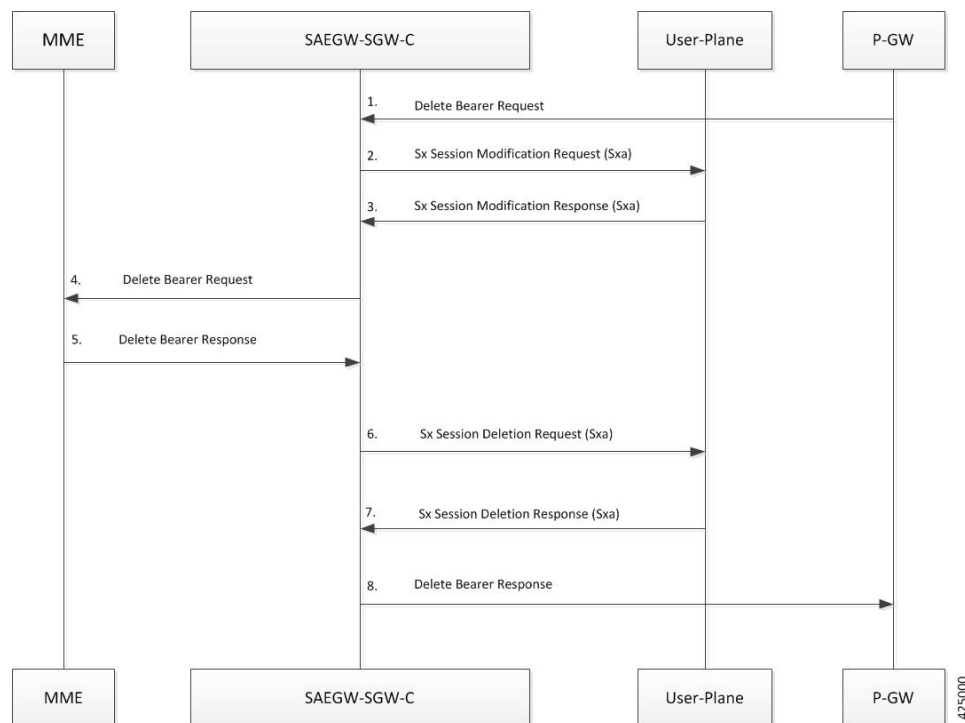

1. On receipt of Delete Bearer Request, the SAEGW-SGW-C performs Sxa interaction to "Update FAR" with Apply Action as "DROP" for both Uplink and Downlink data path.
2. On receipt of Sx Session Modification Response, the SAEGW-SGW-C sends Delete Bearer Request toward the MME.
3. On receipt of Delete Session Response from MME, the SAEGW-SGW-C performs Sxa interaction to delete Sx session.
4. On receipt of Sx Session Deletion Response, the SAEGW-SGW-C sends Delete Bearer Response toward the P-GW.

Detach Procedure (Collapsed): UE Initiated

Following call flow illustrates, at a high-level, the detach procedure for UE initiated Collapsed PDN.

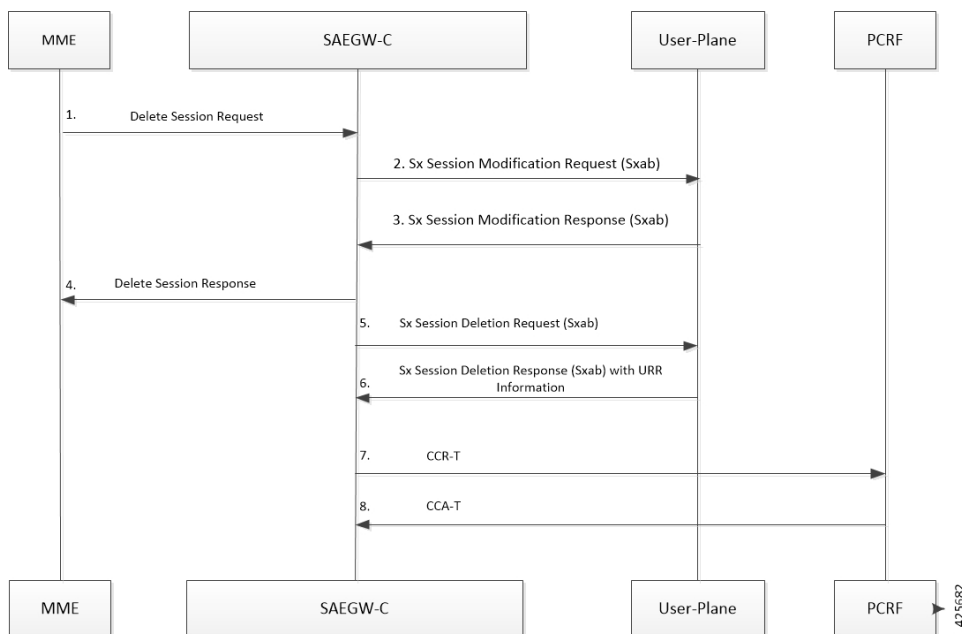

1. On receipt of Delete Session Request, the SAEGW-C performs Sxab interaction to update FAR with Apply Action as "DROP" for both Uplink and Downlink data path.
2. On receipt of Sx Session modification Response, SAEGW-C sends Delete Session Response towards MME.
3. For CUPS SAEGW-Collapsed call, the SAEGW-C does the following:
 - Removes GTP-U session (required for RA/RS in case of IPv6/IPv4v6 PDN).
 - Performs Sxab interaction with the selected User Plane.
4. On receipt of Sx Session Deletion Response, the SAEGW-C does the following:
 - Performs Gx communication (CCR-T and CCA-T).
 - Generates CDR (Gz) based on URR information received.

Detach Procedure (Collapsed): Network Initiated

Following call flow illustrates, at a high-level, the detach procedure for network initiated Collapsed PDN.

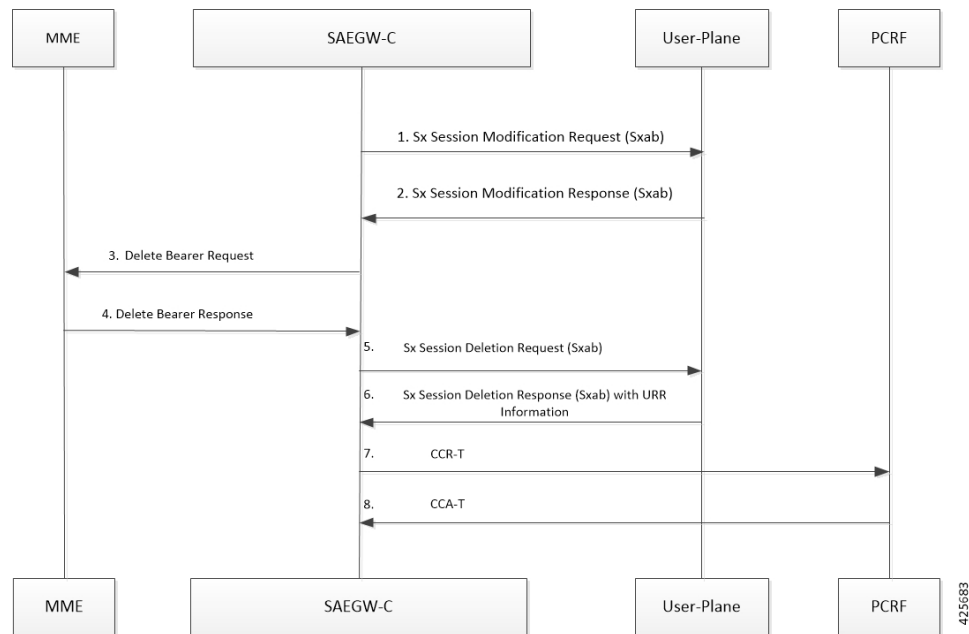

1. On receipt of Delete Bearer Request (RAR initiated or by the **clear sub all** CLI), SAEGW-C performs Sxab interaction to update FAR with Apply Action as "DROP" for both Uplink and Downlink data path.
2. On receipt of Sx Session Modification Response, SAEGW-C sends Delete Bearer Request toward MME.
3. For CUPS SAEGW Collapsed call, the SAEGW-C does the following:
 - Removes GTP-U session (required for RA/RS in case of IPv6/IPv4v6 PDN).
 - Performs Sxab interaction with the selected User Plane.
4. On receipt of Sx Session Deletion Response, the SAEGW-C does the following:
 - Performs Gx communication (CCR-T and CCA-T).
 - Generates CDR (Gz) based on URR information received.

Dedicated Bearer Creation, Modification (Update) and Deletion

Creating, updating and deleting dedicated bearers is only qualified for P-GW and SAEGW.

Bearer Creation in CCA-I (Pure-P)

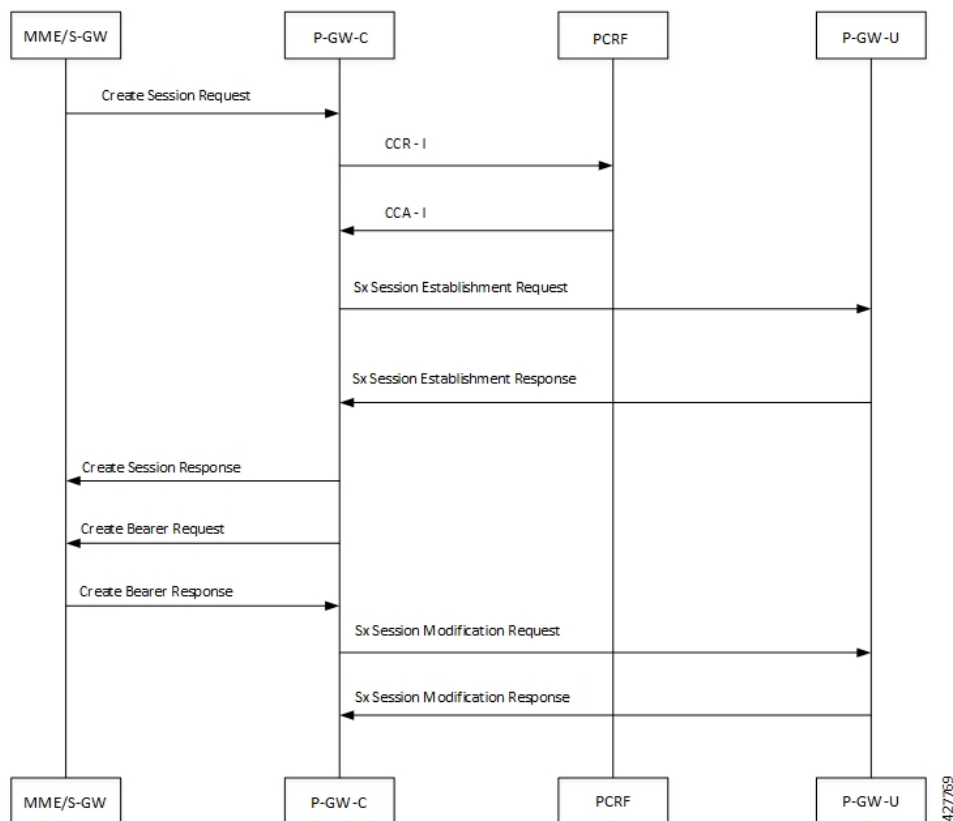

1. UE initiates an attach procedure through the first PDN. S-GW forwards the Create Session Request with IMSI, APN, EBI, and APN AMBR UL/DL along with other mandatory parameters to PGW-C to establish a PDN connection.
2. PGW-C sends a Credit-Control-Request (Initial) to PCRF.
3. PCRF responds with Credit-Control-Answer (Initial) to PGW-C with APN AMBR UL/DL and install dynamic/predefined rule with QCI ARP different from default QoS.
4. On receiving Credit-Control-Answer (Initial) from PCRF, PGW-C initiates a Sx Session Establishment Request to PGW-U with Create PDR for default bearers with choose ID - x, and Create PDR for dedicated bearer with choose ID - y.
5. P-GW-U responds with Sx Session Establishment Response to PGW-C with list of created PDR's and the PGW-U local FTEID's.
6. P-GW-C sends Create Session Response to S-GW for first PDN connection setup.
7. P-GW sends Create Bearer Request to S-GW with the P-GW's Data FTEID filled in the bearer Context.
8. S-GW sends Create Bearer Response with Remote data FTEID. On receiving the same, Sx modify request is initiated towards UP function, to send update FAR for all downlink FAR's, with the remote F-TEID's.
9. P-GW-U responds with an Sx Session Modification Response to P-GW-C.

Bearer Creation due to MBR/MCmd/CCA-U and RAR

Following call flow illustrates, at a high level, bearer creation due to MBR/MCmd/CCA-U and RAR:

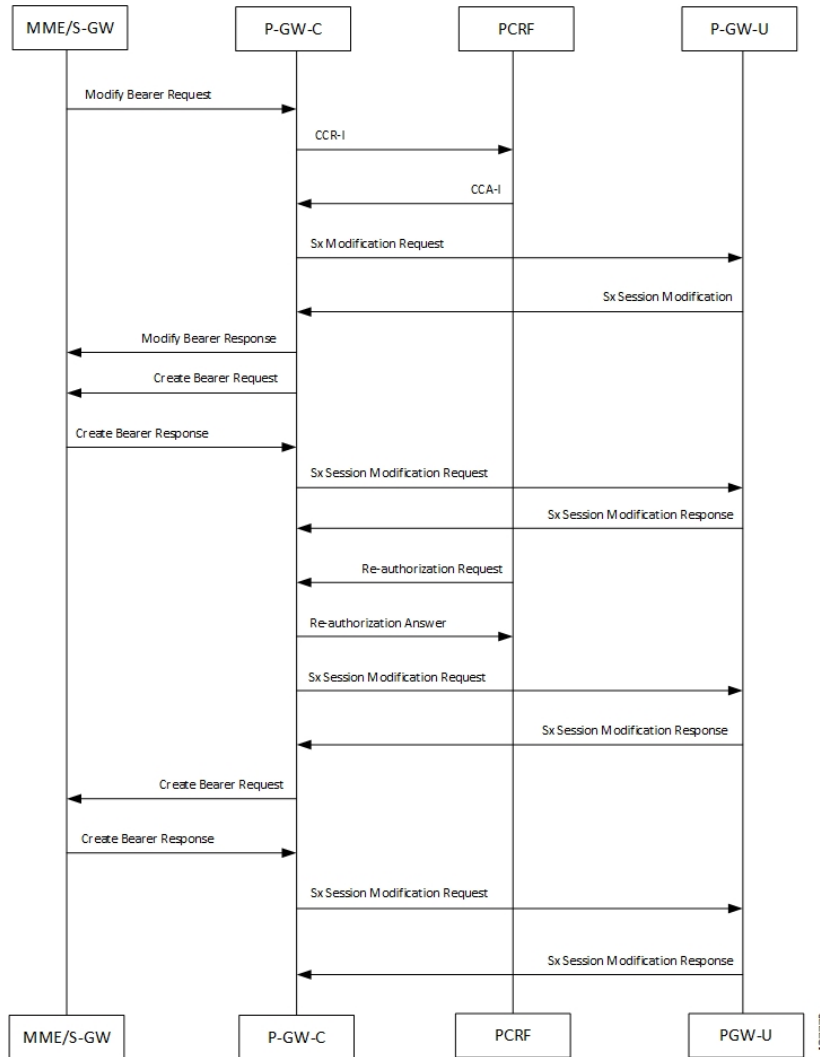

1. On receiving Credit-Control-Answer (Update) or Re-Authorization Request from PCRF, P-GW-C initiates Sx Session Modification Request to P-GW-U with Create PDR for default bearer with choose ID - x, and Create PDR for dedicated bearer with choose ID - y.
2. P-GW-U responds with Sx Session Modification Response to P-GW-C with list of created PDR's and the P-GW-U local FTEID's.
3. P-GW sends Create Bearer Request to S-GW with the P-GW's Data FTEID filled in bearer Context.
4. S-GW sends Create Bearer Response with Remote data FTEID. On receiving the same, Sx modify request is initiated towards UP function, to send update FAR for all downlink FAR's, with the remote F-TEID's.
5. P-GW-U responds with an Sx Modification Response to P-GW-C.

Dedicated Bearer Creation for a Collapsed Call

Following call flow illustrates, at a high level, bearer creation for collapsed call:

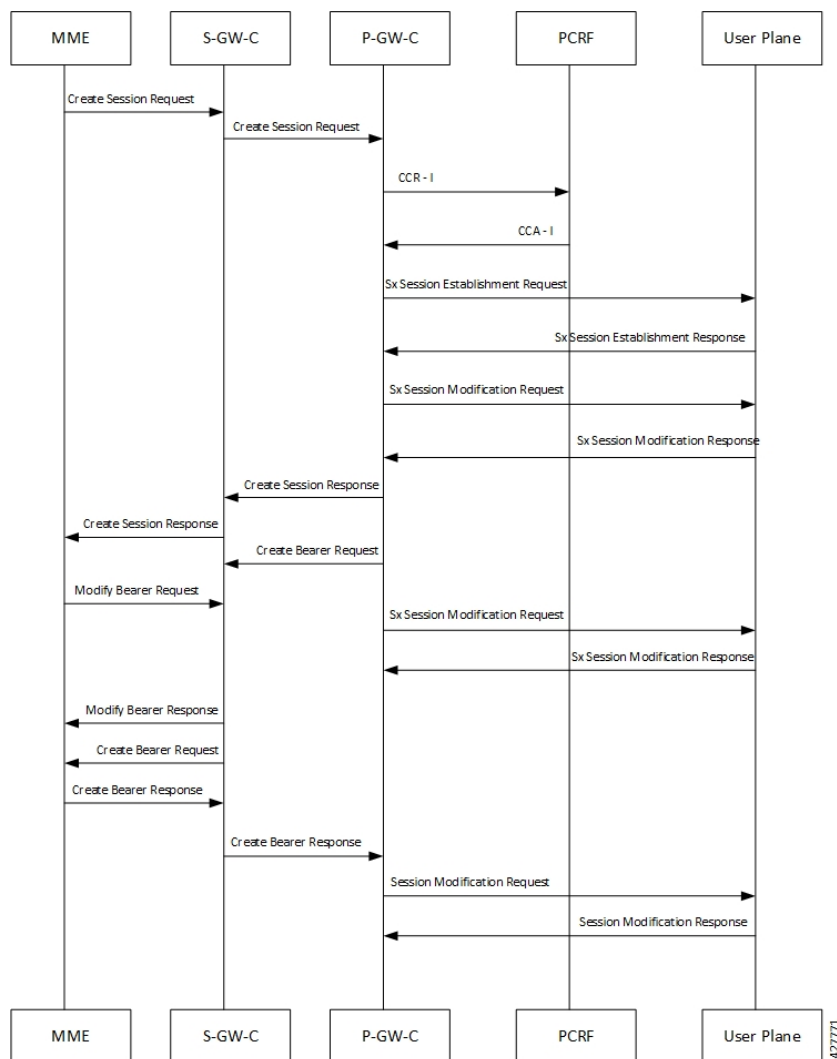

1. UE initiates attach procedure through first PDN. SGW-C forwards the Create Session Request with IMSI, APN, EBI, and APNAMBR UL/DL along with other mandatory parameters to PGW-C to establish a PDN connection.
2. PGW-C sends Credit-Control-Request (Initial) to PCRF.
3. PCRF responds with Credit-Control-Answer (Initial) to PGW-C with APN AMBR UL/DL and install dynamic/predefined rule with QCI ARP different from default QoS.
4. On receiving Credit-Control-Answer (Initial) from PCRF, PGW-C initiates Sx Session Establishment Request to SAEGW-U with Create PDR for default bearer with choose ID x and Create PDR for dedicated bearer with choose ID y.
5. SAEGW-U responds with Sx Session Establishment Response to PGW-C with list of created PDR's and the PGW-U local FTEID's.

6. SAEGW-U responds with Sx Session Establishment Response to PGW-C with list of created PDR's and the PGW-U local FTEID's.
7. PGW-C sends Create Session Response to SGW-C for first PDN connection setup.
8. PGW-C sends Create Bearer Request to SGW-C with the PGW's Data FTEID filled in bearer Context.
9. SGW-C receives Modify bearer request with eNodeB TEID's for which Sx transaction is initiated.
10. SGW-C receives Create Bearer Response with Remote data FTEID. On receiving the same, Sx modify request is initiated towards UP function, to send update FAR's, with the remote F-TEID's.
11. SAEGW-U responds with Sx Session Modification Response to PGW-C.

Bearer Creation with Piggybacking Enabled for Collapsed Call

Following call flow illustrates, at a high level, bearer creation with piggybacking enabled for a collapsed call:

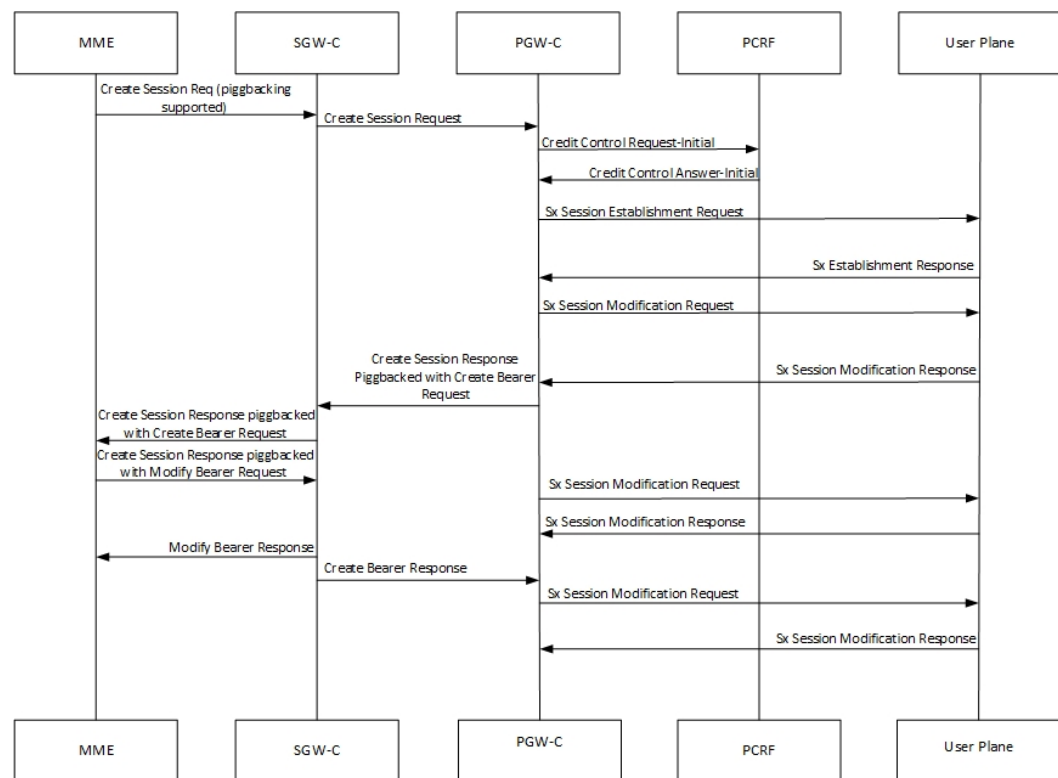

1. UE initiates attach procedure through first PDN.SGW-C forwards the Create Session Request with IMSI, APN, EBI, and APNAMBR UL/DL along with other mandatory parameters to PGW-C to establish a PDN connection.
2. PGW-C sends Credit-Control-Request (Initial) to PCRF.
3. PCRF responds with Credit-Control-Answer (Initial) to PGW-C with APN AMBR UL/DL and install dynamic/predefined rule with QCI ARP different from default QoS.

4. On receiving Credit-Control-Answer (Initial) from PCRF, PGW-C initiates Sx Session Establishment Request to SAEGW-U with Create PDR for default bearer with choose ID x and Create PDR for dedicated bearer with choose ID y.
5. SAEGW-U responds with Sx Session Establishment Response to PGW-C with list of created PDR's and the PGW-U local FTEID's.
6. Sx modification request is triggered to update the PDR and FAR for both default and dedicated bearers.
7. PGW-C sends Create Session Response to SGW-C for first PDN connection setup.
8. PGW-C sends Create Bearer Request to SGW-C with the PGW's Data FTEID filled in bearer Context, which is buffered at SGW-C until PDN is fully connected.
9. SGW-C receives Modify bearer request with eNodeB TEID's for which Sx transaction is initiated.
10. SGW-C received Create Bearer Response with Remote data FTEID. On receiving the same, Sx modify request is initiated towards UP function, to send update FAR for all downlink FAR's, with the remote F-TEID's.
11. SAEGW-U responds with Sx Session Establishment Response to PGW-C.

Delete Bearer Command Call Flow for Pure P Call

Following call flow illustrates, at a high level, command call flow for a Pure P call:

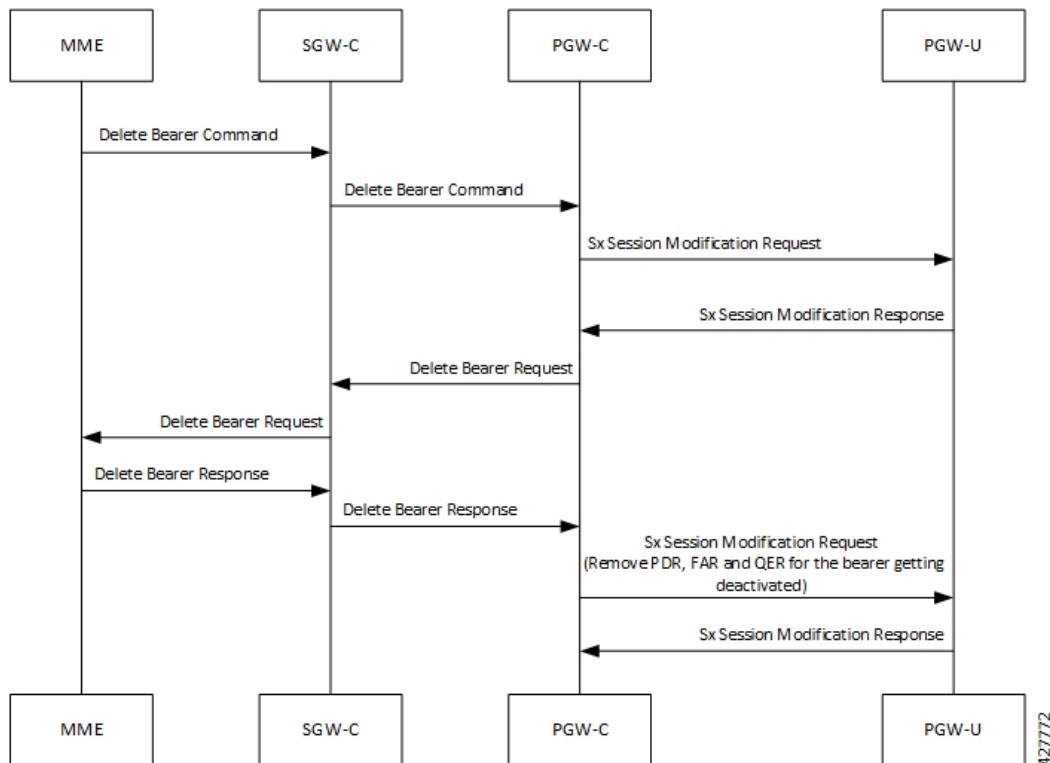

1. UE initiates detach procedure through first PDN.SGW-C forwards the Delete Bearer Command to PGW-C to delete set of dedicated bearers.

2. PGW-C sends an Sx modification Request with All Update FAR for dedicated bearer's with apply action as DROP.
3. PGW-U responds with Sx Session modification Response to PGW-C.
4. PGW-C Sends Delete Bearer Request to access side and on receiving Delete Bearer Response, Sx modification request is triggered to remove the PDR and FAR for dedicated bearers.

Clear Subscriber EBI for Pure P Call

Following call flow illustrates, at a high level, Clear Subscriber EBI for a Pure P call:

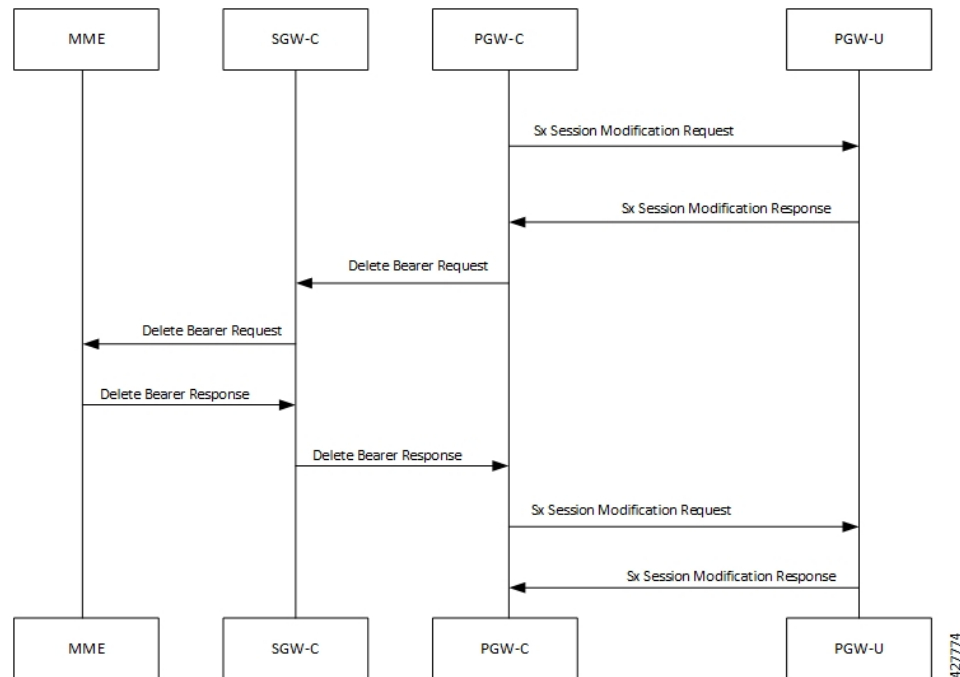

1. PGW-C initiates detach procedure through first PDN.
2. PGW-C sends a Sx modification Request with All Update FAR for dedicated bearer's with apply action as DROP.
3. PGW-U responds with Sx Session modification Response to PGW-C.
4. PGW-C Sends Delete Bearer Request to access side and on receiving Delete Bearer Response, Sx modification request is triggered to remove the PDR and FAR for dedicated bearers.

PCRF Initiated Delete for Pure P Call

Following call flow illustrates, at a high level, PCRF initiated delete for a Pure P call:

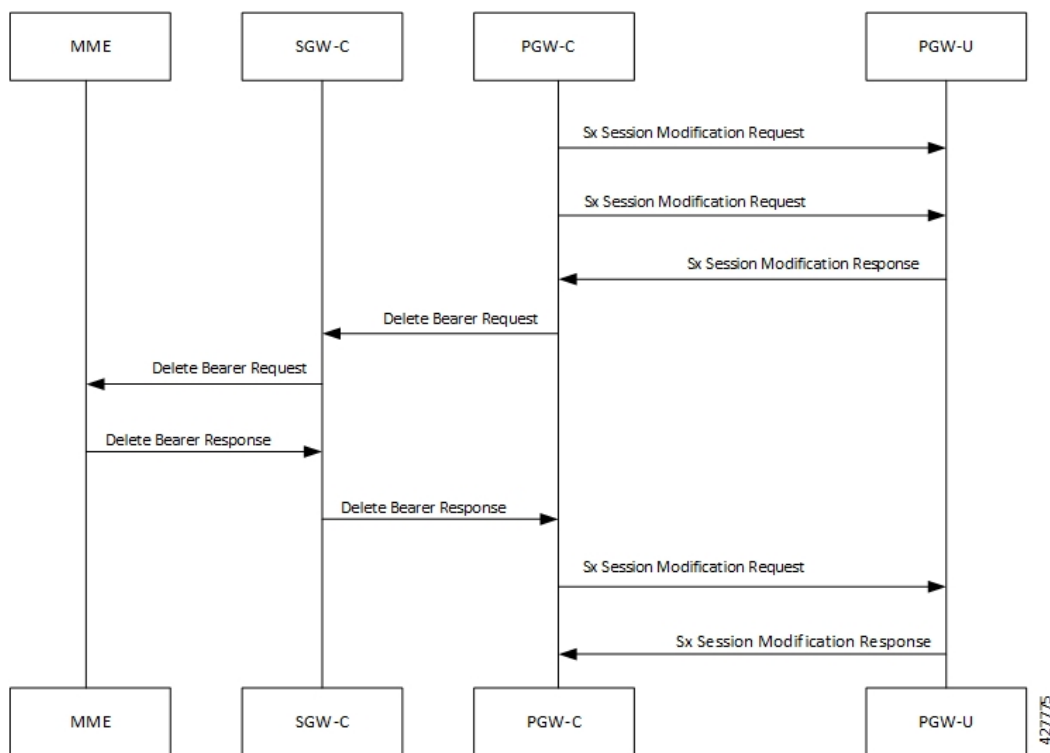

1. PCRF performs Rule-removal, which leads to dedicated bearer deletion.
2. PGW-C initiates Sx modification Request with All Update FAR for dedicated bearer's with apply action as DROP.
3. PGW-U responds with Sx Session modification Response to PGW-C.
4. PGW-C Sends Delete Bearer Request to access side and on receiving Delete Bearer Response, Sx modification request is triggered to remove the PDR and FAR for dedicated bearers.

Limitations

Dedicated Bearer Creation and Deletion and Modification (updating) has the following limitations:

- Dedicated bearer creation for Pure S call is not supported.
- During collision scenarios session clean-up is triggered when events/operations are requested for a bearer, for which deletion is already in progress. For example, a CCA-U/RAR (EBI = 6) is received during an on going DELETE_BEARER_COMMAND (EBI = 6).

Support for Addition, Deletion and Updation of Dedicated Bearers for S-GW

Feature Description

Addition, Deletion and Updation of Dedicated Bearers for Pure-S calls is supported in the CUPS architecture.

The following functionality is added in support of this feature:

- SAEGW-CP supports Create Bearer Request for dedicated bearer for Pure-S Call.

- SAEGW -CP supports multiple bearer contexts in single Create Bearer Request.
- SAEGW-CP supports multiple Create Bearer request in parallel for different PDN; these PDN can be Pure-S PDN or Collapsed and Pure-S combinations.
- SAEGW-UP creates uplink and downlink bearer stream at VPP for Pure-S call per bearer. Number of streams per direction depends on the GTP-U Service IP address.
- SAEGW-CP supports Release Access Bearer Request (RAB) with dedicated bearer, all FAR corresponding to all bearer is modified.
- SAEGW-CP supports Modify Bearer Request (Idle mode, Connected mode) with dedicated bearer.
- SAEGW-CP supports Create Bearer Response Failure handling from MME.
- SAEGW-CP and SAEGW-UP supports DSCP marking for default and dedicated bearer with VPP.
- SAEGW-CP and SAEGW-UP supports Delete Bearer Request for dedicated bearer. SAEGW-UP removes bearer stream and TEP entries belonging to those bearers.
- SAEGW-CP supports Pure-S Dedicated Bearer Creation when call is in IDLE state.
- SAEGW-CP supports Pure-S Dedicated Bearer S-GW Relocation (both X2 and S1-based).
- SAEGW-CP supports Pure-S Dedicated Bearer Update success scenarios.
- SAEGW-CP supports Piggybacking of Create Bearer Request for dedicated bearer for Pure-S call along with Create Session Response.
- SAEGW-CP supports Piggybacking of Create Bearer Response for dedicated bearer for Pure-S call with Modify Bearer Request.
- SAEGW-CP supports Pure-S Dedicated Bearer Creation if P-GW receives bearer creation as part of CCA-I, where P-GW does not send Piggyback request, which results in Create Session Response followed by Create Bearer Request.
- SAEGW-CP supports Session Recovery and ICSR with Pure-S dedicated bearer.
- SAEGW-CP supports Create Bearer Request and Delete Bearer Request (default bearer) collision.
- SAEGW-CP supports Create Bearer Request and Delete Session Request collision.
- SAEGW-CP supports Create Bearer Response and Delete Bearer Request (default bearer) collision.
- SAEGW-CP supports Create Bearer Response and Delete Session Request collision.
- SAEGW-CP supports End Marker with Pure-S default and dedicated bearer.
- SAEGW-UP supports Session Recovery with Pure-S default and dedicated bearer.
- SAEGW-UP supports movement of IP transport from IPv4 to IPv6, or IPv6 to IPv4, during IDLE->Active and Handover procedure on S1U interface. Transport selected on S1U at the time of Attach is supported. For example, eNode handover from IPv4 eNodeB to IPv6 eNodeB will work.
- SAEGW-CP supports CBRsp with Cause Partially Accepted and Context Not Found.
- SAEGW-CP supports Downlink Data Notification for Pure-S Call, so when UE moves to IDLE state for Pure-S call, FAR action is set as BUFFER.

- SAEGW-CP supports Update Bearer Response with cause PARTIALLY_ACCEPTED and context not Found.
- SAEGW-CP supports the Error and Failure handling from other peer nodes including User Plane node.

LTE Handoff with S-GW Relocation Call Flows

In SAEGW deployment, S-GW handles the 'S-GW Relocation Handoff Create Session' request when the subscriber is in the active mode or in the idle mode. In SAEGW deployment, P-GW handles the 'S-GW Relocation Handoff Modify Bearer' request.

In case of Idle Mode TAU, when OI is set to 1, the eNodeB FTEID is not sent in 'Create Session Request' sent from the MME.

In case of Tracking Area Update procedure with the S-GW change call flow is same as X2 based handover with the S-GW change.

In case of Active Subscriber with X2 based handoff, when OI is set to 1, eNodeB FTEID is present in 'Create Session Request' sent from the MME.

In case of S1 based handover, when OI is set to 0, the 'Create Session Request' from MME does not contain the eNodeB FTEID. 'Create Session Request' is followed by 'Modify Bearer Request' from MME, which contains the eNodeB FTEID.

Following sections illustrate the S-GW relocation call flows for X2 and S1 based handover where eNodeB FTEID is present in the 'Create Session Request' of an Active Subscriber.

S-GW Relocation Call Flows for X2 Based Handover

This section covers S-GW relocation call flows for X2 based handover, when OI is set to 1.

S-GW Relocation Procedure (Pure-P)

Following call flow illustrates, the initial attach procedure for a S-GW Relocation Pure-P PDN at a high-level.

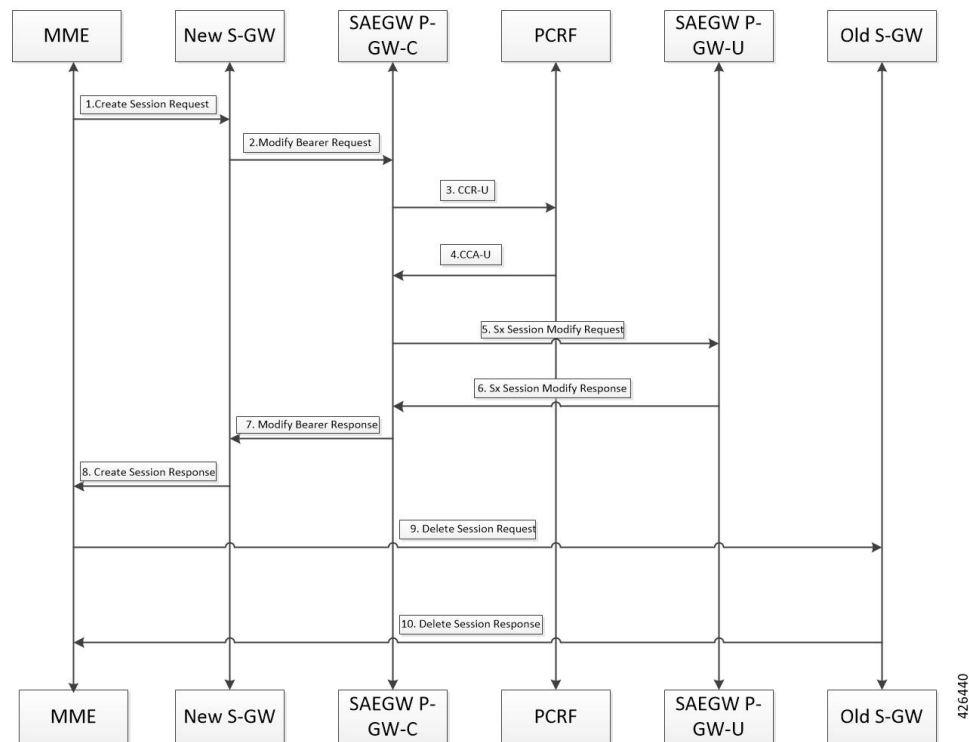

1. On S-GW handover, when the 'Create Session Request' is sent to new S-GW from MME.
2. 'Modify Bearer Request' is sent to SAEGW-P-GW-C from the new S-GW with S-GW S5/S8-U Data FTEID.
3. SAEGW-PGW-C performs Gx communication (CCR-U).
4. SAEGW-PGW-C performs Gx communication (CCA-U).
5. After Gx interaction, SAEGW-P-GW-C triggers 'Sx Modification Request' towards SAEGW-PGW-U. 'Sx Modify Request' contains the following:
 - 'Update PDR (Uplink PDR)' with 'Outer Header Removal' set based on IP address information in S5/S8-U S-GW DATA FTEID.
 - 'Update FAR (Downlink FAR)' with 'Outer Header Creation' set with S5/S8-U S-GW DATA FTEID.
6. SAEGW-P-GW-U sends 'Sx Modification Response'.
7. On receipt of 'Sx Modification Response', SAEGW-P-GW-C sends 'Modify Bearer Response' to the new S-GW.
8. The new S-GW then sends 'Create Session Response' back to the MME.
9. MME sends 'Delete Session Request' to the old S-GW.
10. The old S-GW responds with 'Delete Session Response' to the MME.

S-GW Relocation Procedure (Pure-S)

The following call flow, at a high-level, illustrates the procedure for an S-GW Relocation Pure-S PDN.

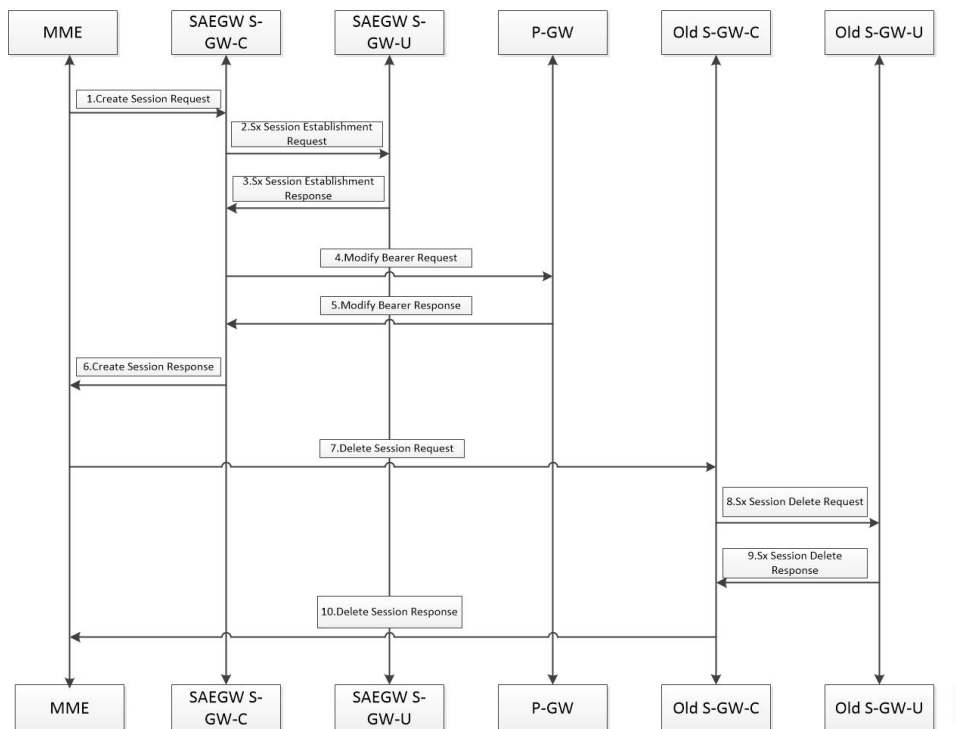

1. On S-GW handover, the MME sends 'Create Session Request' with enodeB FTEID, P-GW S5/S8-U DATA FTEID and P-GW S5/S8-C Ctrl FTEID to the new S-GW-C.
2. The new S-GW-C sends 'Sx Establishment Request' to the new S-GW-U. 'Sx Establishment Request' contains the following:
 - 'Create S-GW Ingress PDR' with 'Outer Header Removal' set based on eNodeB FTEID.
 - 'Create S-GW Egress PDR' with 'Outer Header Removal' set based on P-GW S5/S8-U Data FTEID.
 - 'Create S-GW Ingress FAR' with 'Outer Header Creation' set to P-GW S5/S8-U Data FTEID.
 - 'Create S-GW Egress FAR' with 'Outer Header Creation' set to eNodeB FTEID.
 - 'Create S-GW Egress FAR' with 'Outer Header Creation' set to eNodeB FTEID for X2/In case of TAU S-GW Egress FAR will not contain Outer Header Creation and Apply Action will be set to drop.
3. 'Sx Establishment Response' is received at the S-GW-C with the S-GW S1-U and the S5/S8-U DATA FTEIDs.
4. Once 'Sx Establishment Response' is received from the S-GW-U, the 'Modify Bearer Request' with S-GW S5/S8-U DATA FTEID is sent to the P-GW.
5. When the P-GW responds with the 'Modify Bearer Response'.
6. The new S-GW-C then sends a 'Create Session Response' with S-GW ctrl S11C FTEID and S-GW S1-U DATA FTEID to the MME.

7. On receipt of the 'Create Session Response', the MME sends 'Delete Session Request' to the old S-GW-C.
8. Old S-GW-C sends 'Sx Delete Session Request' to the old S-GW-U.
9. Old S-GW-U responds with the 'Sx Delete Session Response' to the old S-GW-C.
10. Old S-GW-C responds with the 'Delete Session Response' to the MME.

S-GW Relocation Pure-P Call to Collapsed Call

Following call flow illustrates, at a high-level, the procedure for an S-GW Relocation Pure-P call to Collapsed Call.

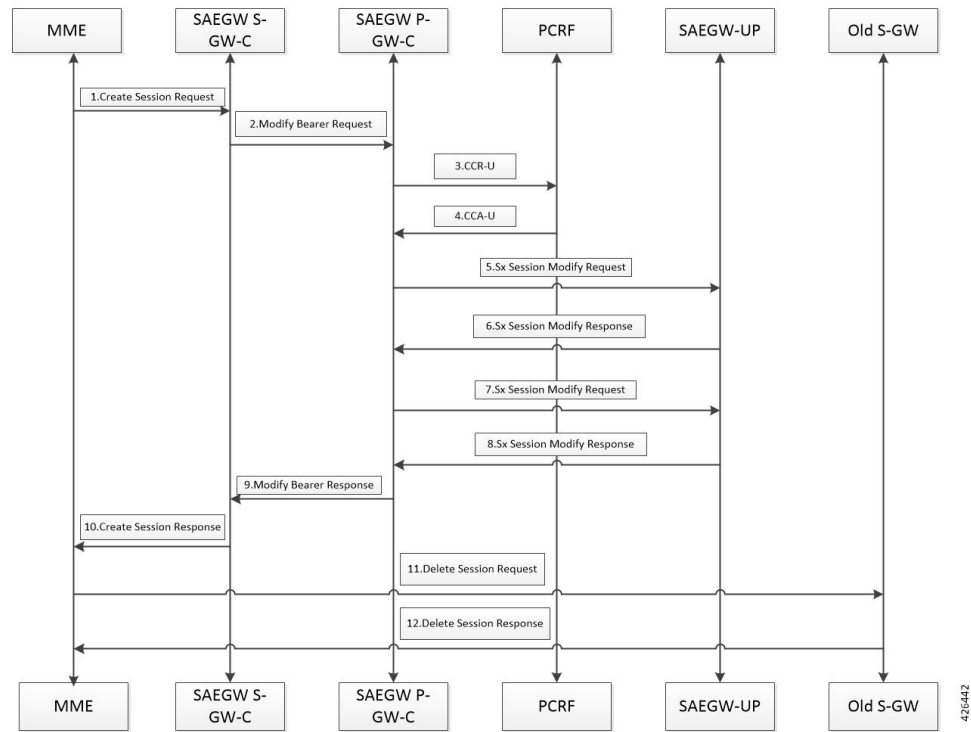

1. On S-GW handover, MME sends 'Create Session Request' to the new SAEGW-SGW-C which is part of the SAEGW anchoring P-GW call of that subscriber.
2. SAEGW-S-GW-C does the following:
 - S-GW-C does not perform any Sx Communication after detecting that it is a collapsed call.
 - S-GW-C triggers 'Modify bearer Request' to the P-GW-C with zero S-GW S5/S8-U Data FTEID.
3. SAEGW-P-GW-C performs Gx communication with PCRF CCR-U.
4. SAEGW-P-GW-C performs Gx communication with PCRF CCA-U.
5. After the Gx interaction is complete, the SAEGW-P-GW-C triggers 'Sx Modification Request' to SAEGW-P-GW-U. Sx Modification Request contains the following:
 - 'Create PDR' and 'Create FAR' (with apply action as DROP) for an S-GW Ingress.
 - 'Create PDR' and 'Create FAR' (with apply action as DROP) for an S-GW Egress.

Control Plane requests User Plane to allocate following S-GW DATA FTEIDS for both uplink and downlink path:

- S-GW S1-U DATA FTEID
- S-GW S5/S8-U DATA FTEID

Interface type changes from Sxb to Sxab, that is, Pure P call to Collapsed call.

6. SAEGW-P-GW-U responds with 'Sx Modification Response' to SAEGW-P-GW-C over Sxab interface.
7. SAEGW-P-GW-C triggers second 'Sx Modification Request' to SAEGW-P-GW-U. The 'Sx Modification Request' contains the following:
 - Update S-GW Ingress PDR with 'Outer Header Removal' set based on eNodeB S1-U DATA FTEID.
 - Update S-GW Egress PDR with 'Outer Header Removal' set based on P-GW S5/S8-U DATA FTEID.
 - Update S-GW Ingress FAR with 'Outer Header Creation' set to P-GW S5/S8-U DATA FTEID and apply action as FORWARD.
 - Update S-GW Egress FAR with 'Outer Header Creation' set to eNodeB S1-U DATA FTEID and apply action as FORWARD. In case of TAU, S-GW Egress FAR will not contain 'Outer Header Creation' and apply action is set to DROP.
 - Update P-GW Egress FAR with 'Outer Header Creation' set to S-GW S5/S8-U DATA FTEID and apply action as FORWARD.
8. SAEGW-P-GW-U sends 'Sx Modification Response' to SAEGW-P-GW-C.
9. On receipt of 'Sx Modification Response', SAEGW-PGW-C sends 'Modify Bearer Response' to SAEGW-S-GW-C.
10. SAEGW-S-GW-C sends 'Create Session Response' with S-GW ctrl S11c FTEID and S-GW S1-U DATA FTEID.
11. MME sends 'Delete Session Request' to the old S-GW.
12. Old S-GW responds with 'Delete Session Response' to the MME.

S-GW Relocation Collapsed Call to Pure-P Call

Following call flow illustrates, the procedure for an S-GW Relocation Collapsed call to a Pure-P Call at a high-level.

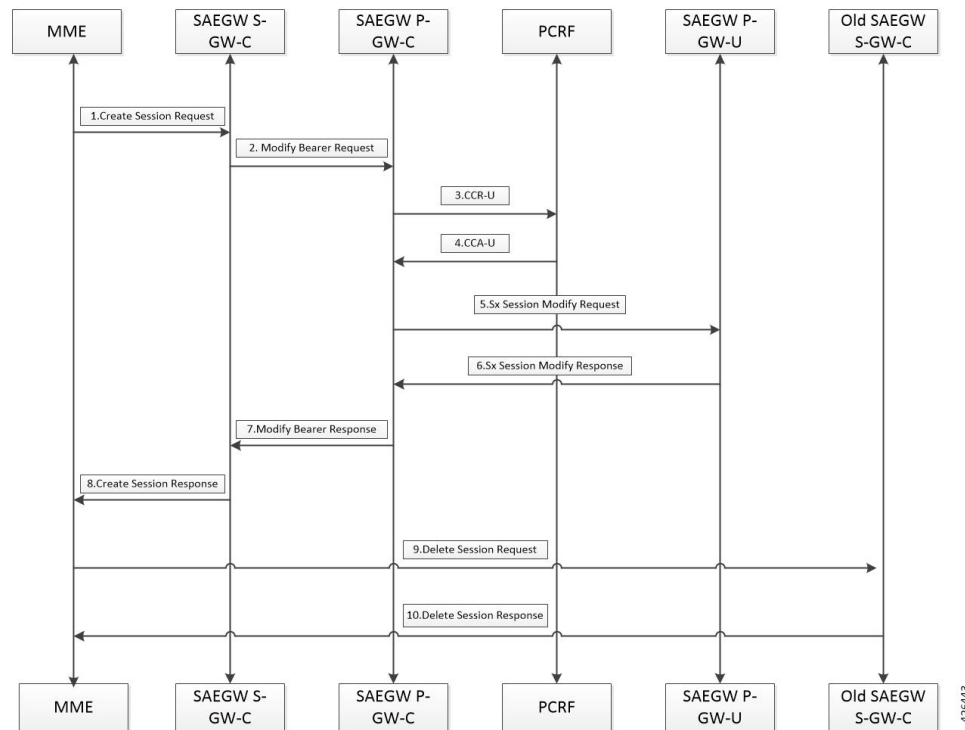

1. On S-GW handover, MME sends 'Create Session Request' to the new S-GW.
2. The new S-GW sends 'Modify Bearer Request' to the SAEGW-P-GW-C with S-GW S5/S8-U DATA FTEID.
3. SAEGW-P-GW-C performs the Gx communication CCR-U.
4. SAEGW-P-GW-C performs the Gx communication CCA-U.
5. After the Gx interaction, SAEGW-P-GW-C sends 'Sx Modification Request' to the SAEGW-P-GW-U.
 - Interface type changes from Sxab to Sxb, that is, Collapsed call to Pure P call.
 - Remove the 'S-GW Ingress PDR' and the Egress PDR (Sxa type PDRs).
 - Remove the 'S-GW Ingress FAR' and the Egress FAR set for the uplink and the downlink data path.
 - Update the 'P-GW Ingress PDR' with 'Outer Header Removal' set based on S-GW S5/S8-U DATA FTEID.
 - Update the 'P-GW Egress FAR' with 'Outer Header Creation' set to S-GW S5/S8-U DATA FTEID.



Note SAEGW/PGW-C retains the Sxa tunnel of source SGW-U until Delete Session Request (DSR) is sent from MME. This tunnel retention enables uplink data to flow over SGW-U till the path switches. Use the **sxa-tunnel-del-at-dsr-on-sgw-change** command in the SAEGW-Service configuration mode to enable or disable Sxa tunnel deletion at DSR. See the *Configuring the Sxa Tunnel Deletion* section for more information.

6. SAEGW-P-GW-U responds with the 'Sx Session Modification Response'.

7. SAEGW-P-GW-C responds with the 'Modify Bearer Response' to the new S-GW.
8. New S-GW responds with the 'Create Session Response' to the MME.
9. On receipt of the 'Create Session Response', MME sends the 'Delete Session Request' to SAEGW-S-GW-C (old S-GW). SAEGW-S-GW-C (old S-GW) does not perform any Sx communication.
10. SAEGW-S-GW-C (old S-GW) responds with the 'Delete Session Response' to the MME.

Configuring the Sxa Tunnel Deletion

To enable or disable Sxa tunnel deletion, use the following command.

```
configure
  context context_name
    saegw-service service_name
      [ no ] sxa-tunnel-del-at-dsr-on-sgw-change
    end
```

NOTES:

- **sxa-tunnel-del-at-dsr-on-sgw-change** : Enable the Sxa tunnel deletion at DSR during X2/S1 based handover with SGW relocation.
- **no sxa-tunnel-del-at-dsr-on-sgw-change** : Disable the Sxa tunnel deletion at DSR during X2/S1 based handover.
- The configuration is disabled by default.
- The configuration will be applied to all current and new sessions.

S-GW Relocation Call Flows for S1 Based Handover

This section covers S-GW relocation call flows for S1 based handover, when OI is set to 0.

Pure-P and Pure-S Call Flows

Following call flow illustrates, at a high-level, the procedure for an S-GW Relocation Pure-P and Pure-S PDN with OI set to 0.

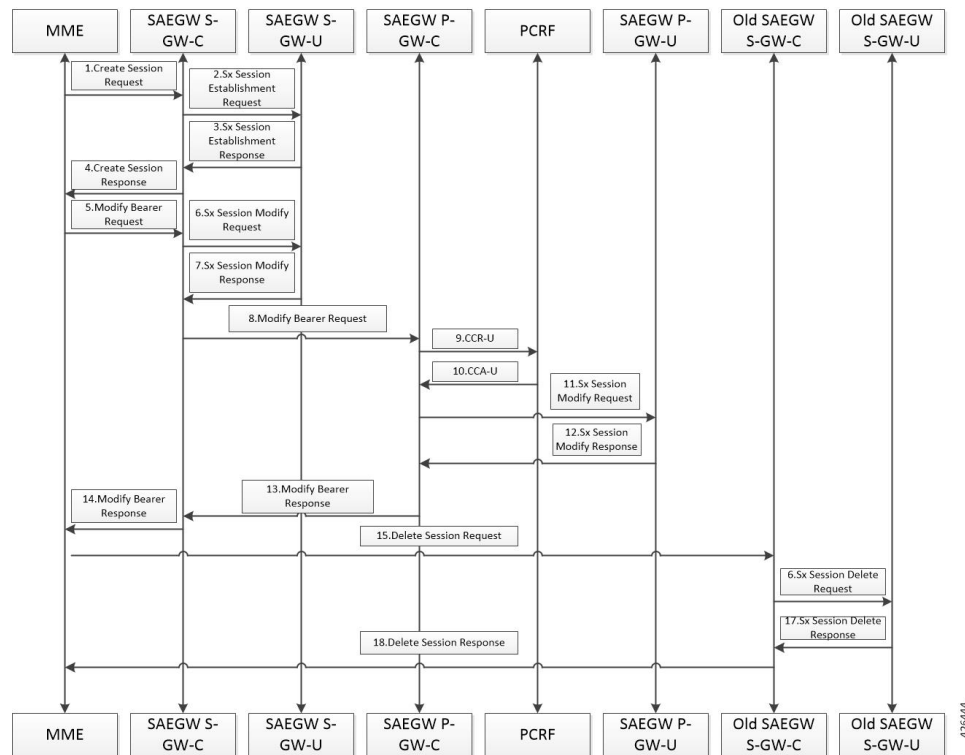

1. On S1 based handover with S-GW change, MME sends the 'Create Session Request' with P-GW S5/S8-U DATA FTEID and P-GW S5/S8-C Ctrl FTEID to the new S-GW-C.
2. The new S-GW-C sends the 'Sx Establishment Request' to the new S-GW-U. 'Sx Establishment Request' contains the following:
 - 'Create S-GW Ingress PDR'.
 - 'Create S-GW Egress PDR' with 'Outer Header Removal' set based on P-GW S5/S8-U Data FTEID.
 - 'Create S-GW Ingress FAR' with 'Outer Header Creation' set to P-GW S5/S8-U Data FTEID.
 - 'Create S-GW Egress FAR' with apply action as DROP.
3. 'Sx Establishment Response' is received at S-GW-C with S-GW S1-U and S5/S8-U DATA FTEIDs allocated at the User Plane.
4. Once 'Sx Establishment Response' is received from S-GW-U, S-GW-C sends 'Create Session Response' to MME.
5. On receiving 'Create Session Response' from S-GW-C, MME sends 'Modify Bearer Request' with eNodeB FTEID to S-GW-C.
6. S-GW-C sends 'Sx Modify Request' to S-GW-U.
 - Updates 'S-GW Ingress PDR' with 'Outer Header Removal' set based on eNodeB FTEID.
 - Updates 'S-GW Egress FAR' with 'Outer Header Creation' set based on eNodeB FTEID.
7. S-GW-U sends 'Sx Modify Response' to S-GW-C.

8. S-GW-C sends 'Modify Bearer Request' with S-GW S5/S8-U DATA FTEID to P-GW-C.
9. On receiving 'Modify Bearer Request' from S-GW-C, P-GW-C performs Gx communication with the PCRF CCR-U.
10. On receiving 'Modify Bearer Request' from S-GW-C, P-GW-C performs Gx communication with the PCRF CCA-U.
11. After the Gx interaction, P-GW-C sends the 'Sx Modification Request' to the P-GW-U. 'Sx Modification Request' contains the following:
 - Updates P-GW Ingress PDR with 'Outer Header Removal' based on the S-GW S5/S8U DATA FTEID.
 - Updates P-GW Egress FAR with 'Outer Header Creation' based on the S-GW S5/S8U DATA FTEID.
12. P-GW-U sends 'Sx Modification Response' back to the P-GW-C.
13. P-GW-C sends the 'Modify Bearer Response' to the S-GW-C.
14. When P-GW responds with the 'Modify Bearer Response', S-GW-C then sends the 'Modify Bearer Response' with the S-GW ctrl S11C FTEID and the S-GW S1-U DATA FTEID to the MME.
15. On receipt of the 'Modify Bearer Response', MME sends the 'Delete Session Request' to the old S-GW-C.
16. The old S-GW-C sends the 'Sx Delete Session Request' to the old S-GW-U.
17. The old S-GW-U responds with the 'Sx Delete Session Response' to the old S-GW-C.
18. The old S-GW-C responds with the 'Delete Session Response' to the MME.

S-GW Relocation Collapsed Call to Pure-P Call

Following call flow illustrates, at a high-level, the procedure for an S-GW Relocation Collapsed call to a Pure-P Call.

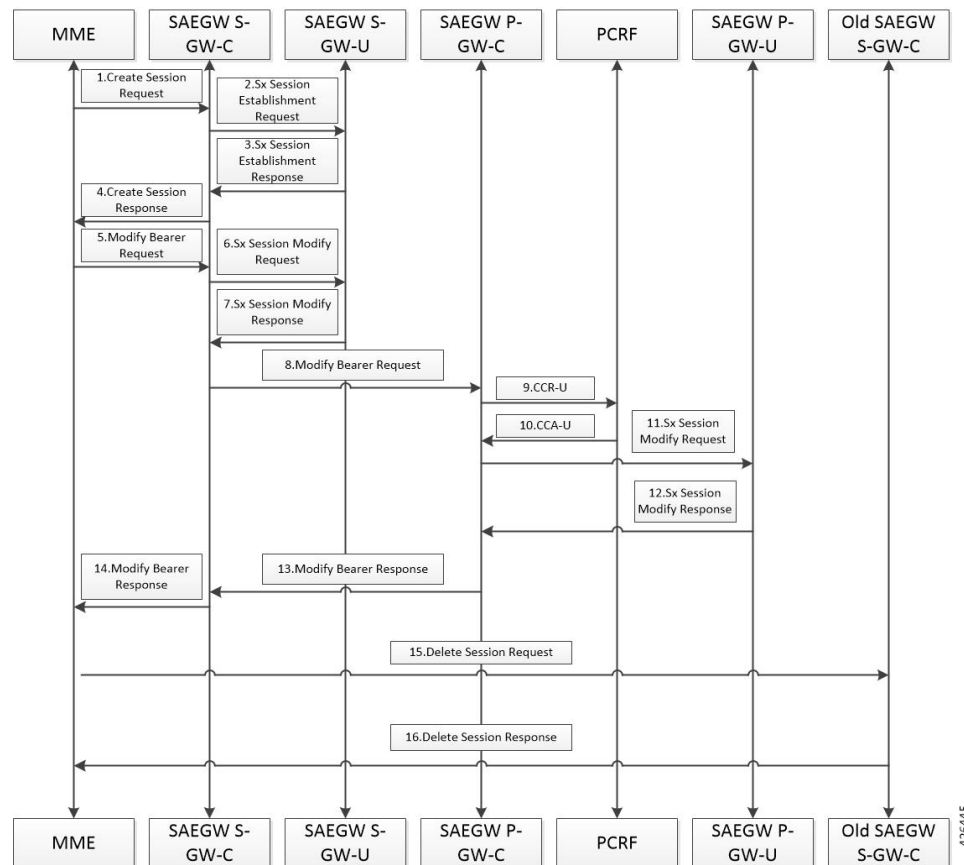

1. On S1 based handover with S-GW change, MME sends 'Create Session Request' with P-GW S5/S8-U DATA FTEID and P-GW S5/S8-C Ctrl FTEID to the new S-GW-C.
2. The new S-GW-C sends 'Sx Establishment Request' to the new S-GW-U. Sx Establishment Request contains the following:
 - 'Create S-GW Ingress PDR'.
 - 'Create S-GW Egress PDR' with 'Outer Header Removal' set based on P-GW S5/S8-U Data FTEID.
 - 'Create S-GW Ingress FAR' with 'Outer Header Creation' set to P-GW S5/S8-U Data FTEID.
 - 'Create S-GW Egress FAR' with apply action as DROP.
3. 'Sx Establishment Response' is received at S-GW-C with S-GW S1-U and S5/S8-U DATA FTEIDs allocated at UP.
4. Once 'Sx Establishment Response' is received from S-GW-U, S-GW-C sends 'Create Session Response' to the MME.
5. On receiving 'Create Session Response' from S-GW-C, MME sends 'Modify Bearer Request' with eNodeB FTEID to S-GW-C.
6. S-GW-C sends 'Sx Modification Request' to the S-GW-U. 'Sx Modification Request' contains the following:
 - 'Update S-GW Ingress PDR' with 'Outer Header Removal' based on eNodeB FTEID.

- 'Update S-GW Egress FAR' with 'Outer Header Creation' based on eNodeB FTEID.
7. S-GW-U sends 'Sx Modification Response' to S-GW-C.
 8. S-GW-C sends 'Modify Bearer Request' with S-GW S5/S8-U DATA FTEID to P-GW-C.
 9. On receiving 'Modify Bearer Request' from S-GW-C, P-GW-C performs Gx communication with the PCRF CCR-U.
 10. On receiving 'Modify Bearer Request' from S-GW-C, P-GW-C performs Gx communication with the PCRF CCA-U.
 11. After Gx interaction, P-GW-C sends 'Sx Modification Request' to the P-GW-U. 'Sx Modification Request' contains the following:
 - Interface type changes from Sxab to Sxb, that is, Collapsed call to Pure P call.
 - 'Remove S-GW Ingress' and 'Egress PDR'.
 - 'Remove S-GW Ingress' and 'Egress FAR'.
 - 'Update P-GW Ingress PDR' with 'Outer Header Removal' based on S-GW S5/S8U DATA FTEID.
 - 'Update P-GW Egress FAR' with 'Outer Header Creation' based on S-GW S5/S8U DATA FTEID.



Note SAEGW/PGW-C retains the Sxa tunnel of source SGW-U until Delete Session Request (DSR) is sent from MME. This tunnel retention enables uplink data to flow over SGW-U till the path switches. Use the **sxa-tunnel-del-at-dsr-on-sgw-change** command in the SAEGW-Service configuration mode to enable or disable Sxa tunnel deletion at DSR. See the *Configuring the Sxa Tunnel Deletion* section for more information.

12. P-GW-U sends 'Sx Modification Response' back to P-GW-C.
13. P-GW-C sends 'Modify Bearer Response' to S-GW-C.
14. When P-GW responds with 'Modify Bearer Response', S-GW-C then sends 'Modify Bearer Response' with S-GW ctrl S11C FTEID and S-GW S1-U DATA FTEID to MME.
15. On receipt of 'Modify Bearer Response', MME sends 'Delete Session Request' to the the old S-GW-C. Old S-GW-C does not perform any Sx communication.
16. Old S-GW-C responds with 'Delete Session Response' to MME.

Configuring the Sxa Tunnel Deletion

To enable or disable Sxa tunnel deletion, use the following command.

```
configure
  context context_name
    saegw-service service_name
      [ no ] sxa-tunnel-del-at-dsr-on-sgw-change
    end
```

NOTES:

- **sxa-tunnel-del-at-dsr-on-sgw-change** : Enable the Sxa tunnel deletion at DSR during X2/S1 based handover with SGW relocation.
- **no sxa-tunnel-del-at-dsr-on-sgw-change** : Disable the Sxa tunnel deletion at DSR during X2/S1 based handover.
- The configuration is disabled by default.
- The configuration will be applied to all current and new sessions.

S-GW Relocation Pure-P Call to Collapsed Call

Following call flow illustrates, the procedure for an S-GW Relocation Pure-P call to Collapsed call at a high-level.

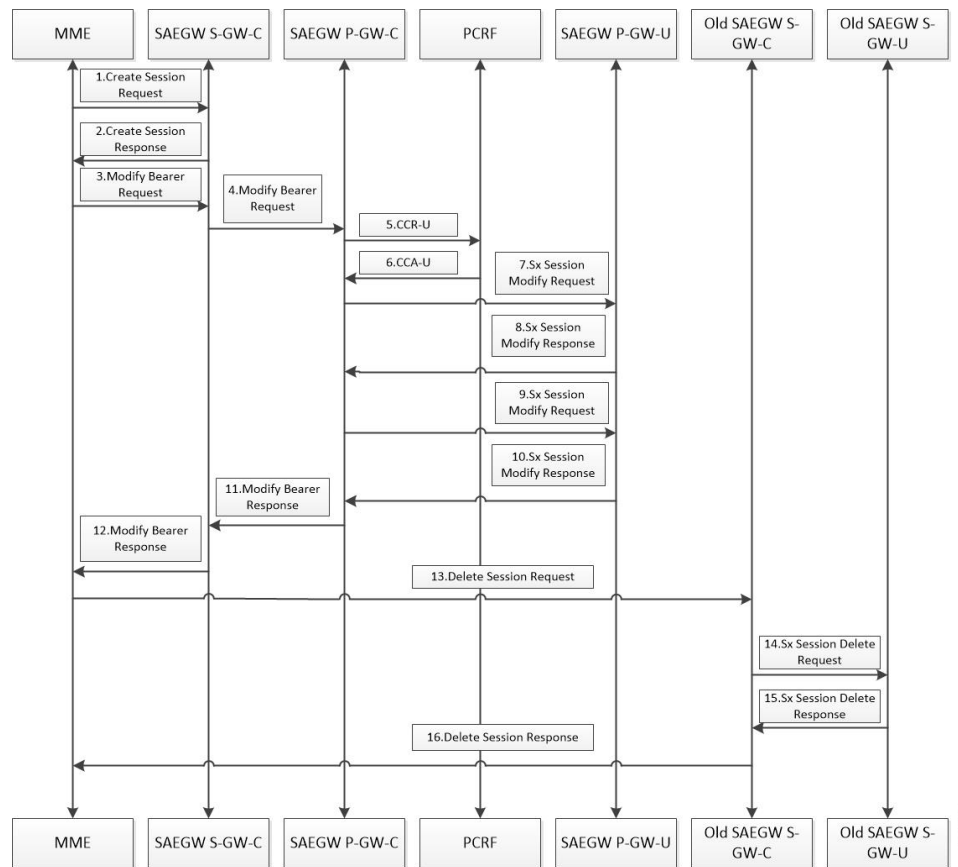

1. On S-GW handover, MME sends 'Create Session Request' to new SAEGW-S-GW-C which is part of SAEGW anchoring P-GW call of that subscriber. SGW-C does not perform any Sx communication after detecting that it is a collapsed call.
2. SGW-C sends 'Create Session Response' back to the MME.
3. On receiving 'Create Session Response', MME sends 'Modify Bearer Request' with eNodeB FTEID to S-GW-C.
4. S-GW-C triggers 'Modify Bearer Request' to P-GW-C with zero S-GW S5/S8-U Data FTEID. Allows zero S5/S8-U SGW DATA FTEID in 'Modify Bearer Request' for the collapsed calls.

5. Performs Gx communication with PCRF CCR-U.
6. Performs Gx communication with PCRF CCA-U.
7. After Gx interaction is complete, the SAEGW-P-GW-C triggers 'Sx Modification Request' to SAEGW-P-GW-U. Sx Modification Request contains the following:
 - 'Create PDR' and 'Create FAR' (with apply action as DROP) for S-GW Ingress.
 - 'Create PDR' and 'Create FAR' (with apply action as DROP) for S-GW Egress.

Control Plane requests User Plane to allocate following S-GW DATA FTEIDS for both uplink and downlink path:

- S-GW S1-U DATA FTEID
- S-GW S5/S8-U DATA FTEID

Interface type changes from Sxb to Sxab, that is, Pure P to Collapsed call.

8. SAEGW-P-GW-U responds with 'Sx Modification Response' to SAEGW-PGW-C over Sxab interface.
9. SAEGW-P-GW-C triggers second 'Sx Modification Request' to SAEGW-P-GW-U. The 'Sx Modification Request' contains the following:
 - 'Update S-GW Ingress PDR' with 'Outer Header Removal' set based on eNodeB S1-U DATA FTEID.
 - 'Update S-GW Egress PDR' with 'Outer Header Removal' set based on P-GW S5/S8-U DATA FTEID.
 - 'Update S-GW Ingress FAR' with 'Outer Header Creation' set to P-GW S5/S8-U DATA FTEID and apply action as FORWARD.
 - 'Update S-GW Egress FAR' with 'Outer Header Creation' set to eNodeB S1-U DATA FTEID and apply action as FORWARD.
 - 'Update P-GW Ingress PDR' with 'Outer Header Removal' based on S-GW S5/S8-U DATA FTEID.
 - 'Update P-GW Egress FAR' with 'Outer Header Creation' set to S-GW S5/S8-U DATA FTEID and apply action as FORWARD.
 - Update the 'P-GW Ingress PDR' with 'Outer Header Removal' set based on S-GW S5/S8-UDATA FTEID.
10. SAEGW-P-GW-U sends 'Sx Modification Response' to SAEGW-P-GW-C.
11. On receipt of 'Sx Modification Response', SAEGW-PGW-C sends 'Modify Bearer Response' to SAEGW-SGW-C.
12. SAEGW-S-GW-C sends 'Modify Bearer Response' with S-GW ctrl S11c FTEID and S-GW S1-U DATA FTEID.
13. On receipt of 'Modify Bearer Response', MME sends 'Delete Session Request' to the old SGW-C.
14. Old SGW-C sends 'Sx Delete Session Request' to the old SGW-U.
15. Old SGW-U responds with 'Sx Delete Session Response' to the old SGW-C.

16. Old SGW-C responds with 'Delete Session Response' to the MME.

PDN Update Procedures

This section highlights the following PDN Update Procedures supported over CUPS architecture.

- UE Initiated Procedures
 - Modify Bearer Command
 - Modify Bearer Request
- Network Initiated Procedures
 - RAR
 - CCA-U (Triggered as part of UE Initiated Procedures or any internal trigger)

The above scenarios are supported for both SAEGW Pure-P and SAEGW Collapsed Call type.

All possible network failure scenarios are also supported, which includes:

- Sx Failures (Sx Modification Response)
- GTP Failures (Update Bearer Response)
- Gx Failures
- Create Bearer Response failure

Failure Handling and Call Drop Scenarios

Following table highlights the various possible Sx/GTP failures scenarios and the resultant P-GW behavior. It also highlights the conditions where the P-GW initiates call termination to avoid inconsistency between Control Plane and User Plane.

Sx Modification Failure Scenarios	P-GW Behaviour
Sx Modification Request is carrying - Query URR NOTE: Sx Modification may or may not carry additional IE's along with Query URR (apart from Revert Scenario) - Dynamic Rule Addition (Create PDR/FAR/URR/QER) - Predefine Rule Addition (Create PDR/URR) - Rule Updation (Update PDR/FAR/URR/QER) - Dynamic Rule Removal (Remove PDR/QER) - Predefine Dynamic Rule Removal (Remove PDR) - APN-AMBR QER Change - DSCP Change (QoS Change)	Call Drop: Yes Disconnect Reason: sxfail-opr-get-usagereport

Sx Modification Failure Scenarios	P-GW Behaviour
a) Sx Modification Request is carrying - Query URR b) Sx Modification Response is received with Cause: Failure + Usage Information	The Usage Information is not processed.
a) Sx Modification Request is carrying 1) Dynamic Rule Addition (Create PDR/FAR/URR/QER) 2) Predefine Rule Addition (Create PDR/URR) 3) Rule Updation (Update PDR/FAR/URR/QER) 4) Dynamic Rule Removal (Remove PDR/QER) 5) Predefine Rule Removal (Remove PDR) 6) APN-AMBR QER Change 7) DSCP Change (QoS Change) 8) Query URR b) Sx Modification Response is received with Cause: Failure	Control Plane sends another "Sx Modification Request" 1) No Action (CP and UP are in sync) 2) No Action (CP and UP are in sync) 3) Remove Rule (Remove "PDR/FAR/URR/QER") so that CP and UP will be in sync. 4) Call Drop (Conditional) a) Remove PDR/URR: Call Drop b) Remove QER/FAR: Retain Call, Error Log 5) Call Drop (Conditional) a) Remove PDR : Call Drop b) Remove QER : Retain Call, Error Log 6) APN-AMBR QER Change: No Action (CP and UP are in sync) 7) DSCP Change (QoS Change): No Action (CP and UP are in sync) 8) Call Drop NOTE: As of now, CP does not send "Remove URR and Remove FAR" as part of Rule Removal event. Disconnect Reason (In priority order) : sxfail-opr-get-usagereport sxfail-opr-create-rulebase-pdr sxfail-opr-remove-pdr

Sx Modification Failure Scenarios	P-GW Behaviour
<p>a) Sx Modification Request is carrying</p> <ol style="list-style-type: none"> 1) Dynamic Rule Addition (Create PDR/FAR/URR/QER) 2) Predefine Rule Addition (Create PDR/URR) 3) Rule Updation (Update PDR/FAR/URR/QER) 4) Dynamic Rule Removal (Remove PDR/QER) 5) Predefine Rule Removal (Remove PDR) 6) APN-AMBR QER Change 7) DSCP Change (QoS Change) 8) Query URR <p>b) Sx Modification Response is received with "Cause : Success", followed by</p> <p>c) Update Bearer Request</p> <p>d) Update Bearer Response (Cause = Failure)</p>	<p>Control Plane send another "Sx Modification Request" to revert back to older state.</p> <ol style="list-style-type: none"> 1) Remove Rule (Remove "PDR/FAR/URR/QER"), So that CP and UP will be in sync. 2) Remove Rule (Remove "PDR/QER"), So that CP and UP will be in sync. 3) Remove Rule (Remove "PDR/FAR/URR/QER") so that CP and UP will be in sync. 4) No Action (CP and UP are in sync) 5) No Action (CP and UP are in sync) 6) Send Retained (Old) APN-AMBR so that CP and UP will be in sync. 7) Send Retained (Old QoS) DSCP so that CP and UP will be in sync. 8) No Action <p>NOTE: As of now, CP does not send "Remove URR and Remove FAR" as part of Rule Removal event.</p>
<p>a) When Sx Modification Request is initiated as part of Update Bearer Response (Failure) : To keep CP and UP in Sync</p> <ol style="list-style-type: none"> 1) Remove PDR/FAR/URR/QER 2) Remove PDR/QER (Predef Rule) 3) Retained(Old) APN-AMBR QER 4) Retained(Old) DSCP 5) Query URR <p>b) Sx Modification Response is received with "Cause : Failure"</p>	<p>1) Call Drop</p> <ol style="list-style-type: none"> a) Remove PDR/URR : Call Drop b) Remove QER/FAR : Retain Call, Error Log <p>2) Call Drop (Conditional)</p> <ol style="list-style-type: none"> a) Remove PDR : Call Drop b) Remove QER : Retain Call, Error Log <p>3) Call Drop</p> <p>4) Call Drop</p> <p>5) Query URR : Call Drop</p> <p>Disconnect Reason : sxfail-opr-revert-info</p>
<p>When Sx Modification Request is sent and fails because of:</p> <ul style="list-style-type: none"> - Sx Modification Response (Context Not Found) - No Sx Modification Response (Sx Retransmission Timeout) 	<p>Call Drop: Yes</p> <p>Disconnect Reason : sx-cntxt-not-found sx-no-response</p>

Scenario's	Call Drop
Context Not Found (GTP/Sx)	Yes
Retransmission Timeout (GTP/Sx)	Yes
GTP Cause : Temp fail Temp Failure CLI is not configured	No, Sx Mod (Revert to old APN-AMBR/Default QoS values or Remove Rules)
GTP Cause : Temp fail (Retry Exhausted) Temp Failure CLI is configured	No, Sx Mod (Revert to old APN-AMBR/Default QoS values or Remove Rules)
MBC -> UBReq -> UBRsp (No Resource Available)	Call drop behaviour should be inline with non-cups
MBR/RAR -> UBReq -> UBRsp (No Resource Available)	No, Sx Mod (Revert to old APN-AMBR/Default QoS values or Remove Rules)
Other cause (GTP/Sx)	No, Sx Mod (Revert to old APN-AMBR/Default QoS values or Remove Rules)

PDN Update Procedures - eNodeB F-TEIDu

Feature Description

As a part of the CUPS architecture, a procedure to initiate an Sx Modification Request has been implemented for an eNodeB F-TEIDu update or a Release Access Bearer (RAB) Request for an eNodeB release for an S-GW or SAE-GW.

How It Works

The PDN update procedures includes the following events for an eNodeB F-TEIDu Update/Release:

- For eNodeB F-TEIDu Update
 1. The SGW-C initiates an Sx Session Modification Request towards SGW-U on receiving a Modify Bearer Request for eNodeB F-TEIDu Update from the MME.
 2. The Sx Modification Request for eNodeB F-TEIDu update contains Update FAR with Apply Action as “Forward” and the updated eNodeB IPv4/IPv6 address in Outer Header Creation, which are a part of the Update Forwarding Parameters IE.
- For eNodeB F-TEIDu Release
 1. The SGW-C initiates an Sx Modification Request towards SGW-U on receiving a RAB Request from the MME.
 2. RAB is a UE-level message. If the UE has multiple PDN connections then the Sx Modification Request is sent to each PDN connection separately.
 3. SGW-C initiates Sx Session Modification Request towards SGW-U for the Sx session with Update FAR with destination interface as ACCESS. Update FAR contains: FAR ID and Apply Action as Drop. FAR with the destination interface as CORE is not updated.

Standards Compliance

The PDN Update procedure complies with the following standards:

- 3GPP TS 23.401: "General Packet Radio Service (GPRS) enhancements for Evolved Universal Terrestrial Radio Access Network (E-UTRAN) access".
- 3GPP TS 29.274: "3GPP Evolved Packet System (EPS); Evolved General Packet Radio Service (GPRS) Tunnelling Protocol for Control plane (GTPv2-C); Stage 3".
- 3GPP TS 29.244: "Interface between the Control Plane and the User Plane of EPC".
- 3GPP TS 23.214: "Architecture enhancements for control and user plane separation of EPC nodes; Stage 2".
- 3GPP TS 23.714: "Study on control and user plane separation of EPC nodes".

Gx Update Procedures

Following is the behavior of Gx update procedure:

- Common FAR is used for the PDRs if FAR attributes are the same.
- In case of update of (only) flow status/rating group, Update QER/URR is sent. That is to say, no Update PDR is sent in such cases.
- Rule installation triggers Create PDR and Create QER (SDF level), and may or may not have Create FAR and Create URR (rule can reuse FAR and URR of other rules).
- Rule modification for a flow status/rating group triggers Update QER/Update URR and may or may not have Update PDR (that is, no TFT/QoS change).
- Rule modification for TFT/QoS triggers Update PDR and may or may not have Update QER/Update URR (no QER/URR change).
- Rule removal is triggered in case of Update QER, Update URR, Update FAR, or Update PDR failure as part of Sx modify.
- Call drop is initiated if failure happens for Remove PDR and Create PDR (of rule base).
- APN-AMBR change received from PCRF triggers Update QER.
- The default-eps-bearer-qos change, received from PCRF, triggers Update FAR if there is a change in DSCP marking corresponding to the new QoS.

P-GW Session Reporting with Gy Interface

This section describes P-GW session reporting with Gy interface.

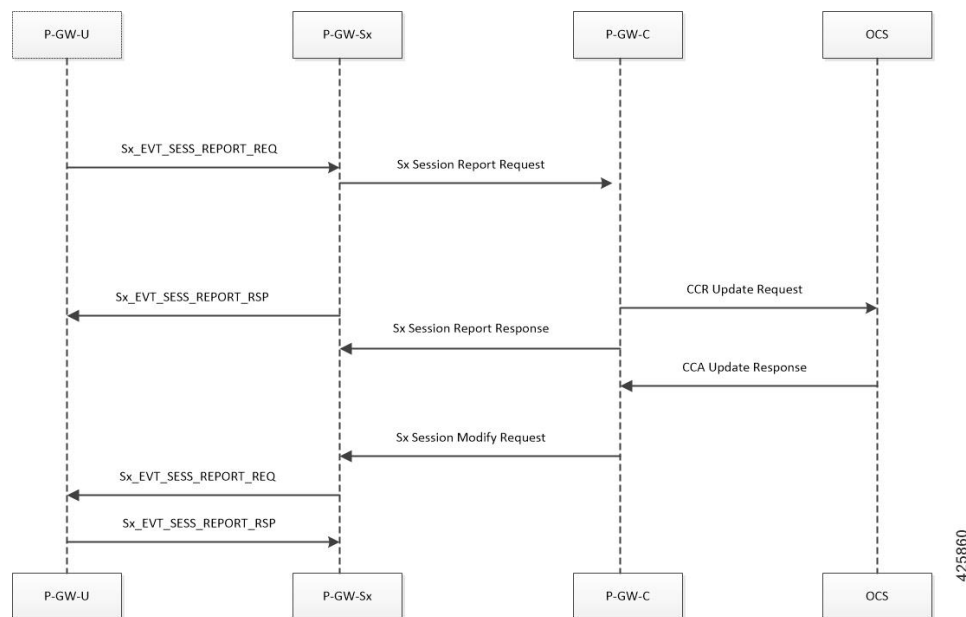

URR Creation During Session Setup

- Control Plane function sends a list of URRs in the Sx Session Establishment request, along with their references in corresponding PDRs.
- The CCR/CCA-I message exchange happens by the time the Sx-Session-Establishment request is generated by the CP, and the quota for the Dynamic-Rules and Pre-emptive MSCCs is received from the OCS.

URR Creation during Session-Modification/Mid-Session

- When a Rule-Modification/install occurs from PCRF in mid-session, then the Sx Session Modification request is used to provision the PDRs and URRs. When creating the URR in the mid-session, if the Quota information is not present in the OCS, then the “Start-of-Packet” trigger is set along with the Measurement Methods: Time & Volume.
- On the arrival of the first packet, the "Start-of-Packet" trigger is sent to the Control Plane for packet-detection, and the Control Plane initiates the Quota negotiation with the OCS server.

URR Processing in Session Disconnect

- The P-GW User Plane sends the URR information as part of Sx Session Delete Response.
- The P-GW Control Plane does the mapping of these URRs to corresponding MSCC buckets and uses existing framework to send the Credit-Control-Messages on the Gy/Ro interface.

Session Delete Response

- P-GW User Plane sends the URR information as part of the Sx Delete Response.
- PGW Control Plane maps these URRs to the corresponding MSCC buckets and use the existing framework to send the Credit-Control-Messages on the Gy/Ro interface.

Sx Session Report Request Handling

P-GW User Plane sends the Usage report for triggers like volume, time-quota, threshold, validity-time, quota-hold-time and so on. P-GW Control Plane maps the URRs to the corresponding charging buckets (MSCC). It initiates the Credit-Control-Request Update for the respective MSCCs.

URR Reporting Handling for Gy

The URR reporting results in Credit-Control-Request-Update generation, depending on the trigger that is sent by the P-GW User Plane.

- When User Plane reports a URR for any trigger, it is first mapped to the MSCC bucket at the Control Plane. The values are updated in the MSCC data-structure.
- After the URR buckets are processed in the current reporting, the Control Plane analyzes the MSCC buckets that are being updated. It initiates the Credit-Control-Request Update request containing all the MSCC-buckets.



Important For this release, the single MSCC-per-update feature is not supported.

Failure Handling Support for Gy

The Failure-Handling configuration is to specify the action to be taken when a failure occurs during communication with the OCS server. The possible Failure-Handling configurations are Continue, Terminate, Retry, and Terminate. The Terminate and Retry-Terminate are solely at the Control Plane. For Continue, the following actions are performed:

- When the CCFH Continue action is applied, all the Gy URRs are disassociated and removed from the PDRs, so that no further reporting/charging occurs for the Online Charging.
- The "removeURR" IE is provisioned for all the Gy URRs to the User Plane, and the User Plane clears all the references to the URR and does the removal internally.
- Handling of MSCC level Error-Result-Codes is supported excluding the following mscs-result-codes: 4010, 4012, 5003, 5012, and 5031.

Re-Authorization-Request Handling

When the RAR request comes from the OCS server, the Control Plane sends the "QueryURR" for the required Charging-Buckets to the User Plane. When the User Plane sends back the URR report to the Control Plane, the Control Plane sends the CCR-Update for the FORCED_REAUTHORIZATION trigger.

Quota-Validity-Time Handling

When the Quota-Validity-Time is received for an MSCC bucket, the same is sent to the User Plane. Since there is no specific IE that can be used directly, the QVT value is filled in the Time-Quota IE, and URR is sent to the User Plane. The lesser QVT or Time-Quota is set in the Time-Quota IE. And, the Usage-Reporting from the User Plane for the Time-Quota trigger, the interpretation is made and the CCR-Update for the Validity-Timeout is generated.

Re-Authorization of the Blacklisted Content

The category Multiple-Services-Credit-Control (MSCC) gets blacklisted when it receives the 4012/4010 result codes at the MSCC level. It indicates that no further packets pass for this category but instead it drops. In CUPS, FAR is created with the DROP action, and is linked to the URR and sent to the UP as part of the QuotaFAR along with the 0 quota, so that the UP starts applying the DROP action.

In non-CUPS architecture, there is a provision to re-authorize these blacklisted contents, on the next packets after the timer expiry (the timer is either locally configured – quota-retry-timer, or ocs provided – gating-expire-timer). After this timer expires, on the arrival of the next packets, it triggers the quota-allocation-request to the OCS. To implement this in the CUPS mode, run the timer in the CP (new timer – in case of the non-CUPS architecture it accomplishes by comparing the timestamps).

On expiry of the timer (either GET or QRT timer), the FAR is removed from the URR, and URR is modified with the Start-of-Traffic trigger. On the next packets arrival, there is a URR reporting to CP for the Start-of-Traffic. This information can be used at CP to request the quota to OCS and get the new quota allocation.

The variation of this feature is the configuration of the CLI, **diameter reauth-blacklisted-content**. It says that the OCS can send the RAR for requesting the re-enabling of the blacklisted categories.

Server-Unreachable Support for Gy

The Server-Unreachable (SU) mechanism is configured on the Control-Plane (CP), for the Gy interface in order to resolve issues that are encountered on the Online Charging System (OCS) or with the connectivity between Policy and Charging Enforcement Function (PCEF) and OCS. The SU configuration provides the options to continue the session even after a failure by providing the option to use configurable interim quota (volume and/or time) and configurable server retries before a session is converted to offline or terminated.

A new Usage Reporting Rule (URR) bucket is created, which contains the SU quota when a Gy session goes into the SU state. The ID for the new URR is generated dynamically when the SU URR is allocated.

In a CUPS User Plane (UP) node, the existing Vector Packet Processor (VPP) streams are modified with a new LC record, which contains the updated SU URR bucket along with the existing set of charging buckets.

When the VPP streams are in the SU state, two quota rows are available, GyURR and SU URR. When GyURR is in the SU state with linked-usage-reporting trigger set, the quota row for the SU URR is linked to the VPP streams.

The following diagram describes the SU call flow in CUPS.

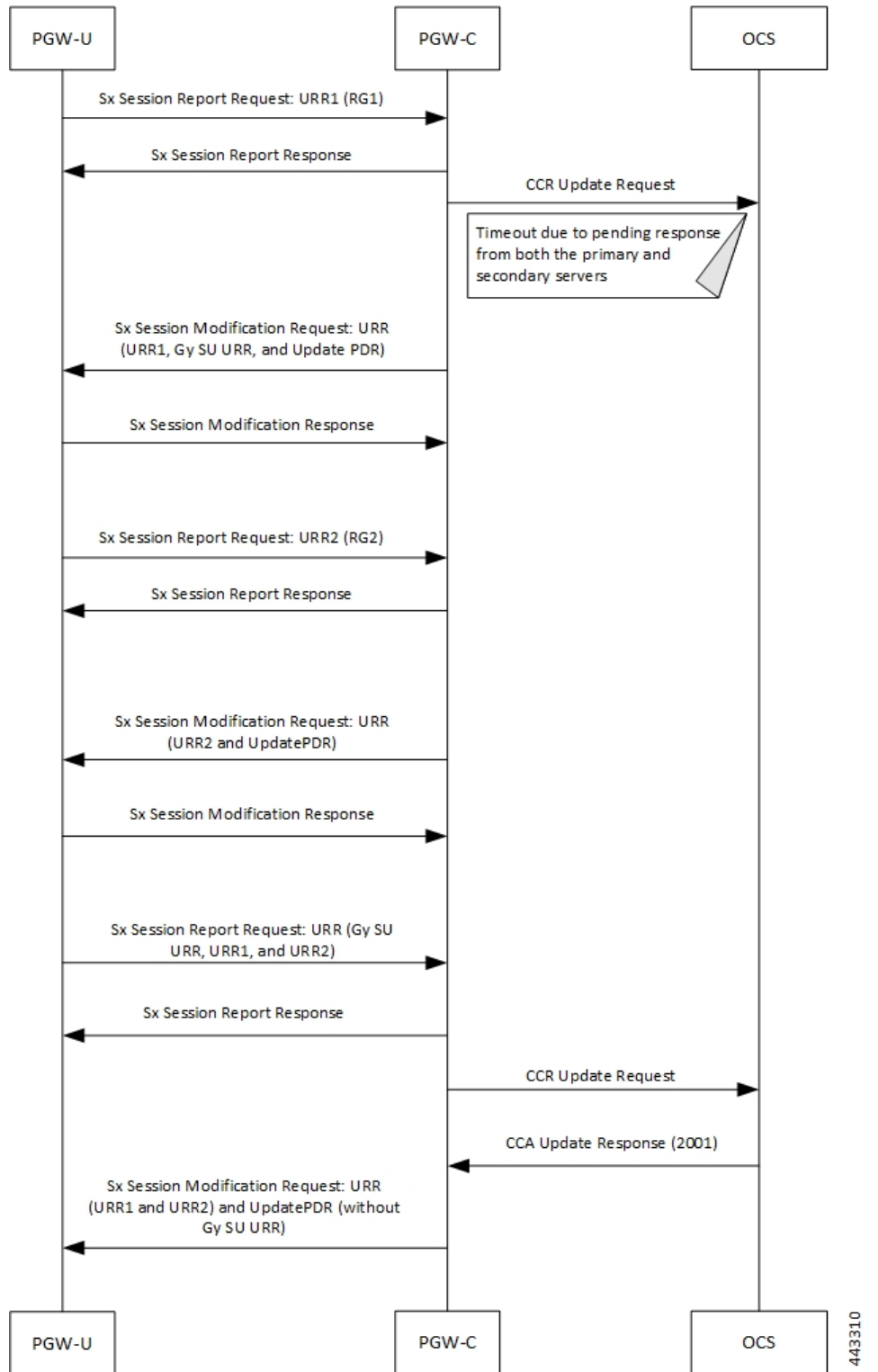

Step	Description
1	PGW-U sends a Sx Session Report Request message with URR1 (RG-1) to PGW-C due to internal triggers like Time and Volume or Quota and Threshold.
2	PGW-C acknowledges the request and sends a Sx Session Report Response message to PGW-U.
3	PGW-C sends CCR Update (CCR-U) Request message to both the primary and secondary OCS.
4	When the CCR-U Request messages fail at both primary and secondary OCS, the Gy session enters an SU state. The SU URR is created for the Gy session, and it's linked to the relevant PDRs. PGW-C sends an Sx Session Modification Request message to PGW-U with UpdatePDR, which includes Gy SU URR in the PDR URR list.
5	PGW-U starts updating the usage in both the Gy buckets (URR1 and Gy SU URR1) and sends an Sx Session Modification Response message to PGW-C.
6	PGW-U sends another Sx Session Report Request message with URR2 (RG-2) to PGW-C after the Gy URR bucket exhausts the quota .
7	PGW-C acknowledges the request sends a Sx Session Report Response message to PGW-U.
8	PGW-C sends an Sx Session Modification Request message to PGW-U with UpdatePDR and Update RR2. The UpdatePDR has a modified URR list, which contains both URR2 and Gy SU URR.
9	PGW-U sends an Sx Session Modification Response message to PGW-C.
10	PGW-U sends a Sx Session Report Request message with URR1 (RG-1) and URR2 (RG-2) to PGW-C after the Gy SU URR quota is exhausted.
11	PGW-C acknowledges the request and sends a Sx Session Report Response.
12	PGW-C sends CCR Update (CCR-U) Request message to OCS after an SU retry.
13	OCS sends a CCA Update Response message with the Result-Code as 2001.
14	PGW-C sends an Sx Modification Request message with URR1 (RG-1), URR2 (RG-2), and UpdatePDR (without Gy SU URR) to PGW-U.

New Behavior in CUPS

The new SU mechanism in CUPS, are as follows:

- In a non CUPS architecture, where a single node (P-GW) processes the Gy session state and the data-traffic, an SU URR is created without any messaging delay. However, in the CUPS mode, the CP forms an additional node, which maintains information about the session state and handles any URR requests from the User Plane (UP). Only the CP can associate a Gy session with an SU URR. This messaging between UP and CP causes a delay and the data packets are treated according to the Pending-Traffic-Treatment configuration to complete the communication.
- In a non CUPS architecture, the SU state timer is processed in a different manner compared to the Time-Quota timer. After an SU quota is exhausted, the retry attempt to OCS occurs and a new next-interim-time-quota is started. However, in the CUPS mode, when the SU Time Quota is used and it is reported to CP for the Quota Exhaust, and if the session goes into Server-Unreachable state again, the time elapsed from the last Usage-Report is accounted in the usage.

- It's not recommended to use the **servers-unreachable after-timer-expiry** *timeout_period* CLI command in CUPS. Instead, use the **servers-unreachable after-interim-time** *timeout_period* **server-retries** *retry_count* to achieve similar behavior but with a single retry (set *retry_count* to 1).

Limit-Reached Postprocessing

Limit-reached-post-processing is a non-3GPP, proprietary behavior supported in both CUPS and non-CUPS architecture. This feature allows redirection or restriction operation implemented when the quota is exhausted for the charging-bucket, however, the OCS server is unable to grant the FUI-Redirect or FUI-Restrict. When using this feature, the operator can combine all the rule-matching criteria that are available—for example, to enable IMSI-based matching criteria, and so on—to selectively apply different handling for different subscribers/traffic. Use the following CLI commands to enable the feature.

```
configure
  active-charging service service_name
    rulebase rulebase_name
    post-processing policy always
  end
```

Also, **rule-application post-processing** CLI command must be configured as limit-reached under ACS Ruledef configuration mode.

PTT no-quota Limited Pass

This feature allows the subscriber to use the network while waiting for the response from OCS. The Limited-Pass configuration allows to specify the Volume which the subscriber can consume while waiting for the quota-response from OCS. The usage is accounted in the respective charging bucket and are adjusted against the next-quota allocation.

Use the following CLI commands to enable the feature:

```
configure
  active-charging service service_name
    credit-control
      pending-traffic-treatment noquota limited-pass volume volume
    end
```

Limited Pass Volume is used only for **noquota** case (Rating Group (RG) seeking quota for the first time) and not for **quota-exhausted**. Limited Pass Volume isn't used for subsequent credit requests.

The traffic is allowed to pass until the Limited-Pass Volume gets exhausted. The usage is counted in the respected charging-bucket and adjusted against the "Quota" granted. If the "Quota" allocation is less than the actual usage, immediate reporting towards OCS with the usage-report occurs requesting for more quota allocation. The subsequent incoming packets are handled as per the "quota-exhausted" PTT configuration.

If the Limited Pass Volume is NOT exhausted before the OCS responds with denial of quota, traffic is blocked after the OCS response. The gateway reports usage on Limited-Pass Volume even in for CCR-U (FINAL) (in non-CUPS) or CCR-T (for CUPS) until the OCS responds.

If the Limited Pass Volume is exhausted before the OCS responds, then the subsequent incoming packets for the session are dropped until quota is granted from OCS.

The default pending-traffic-treatment for **noquota** is Drop. The **default pending-traffic-treatment noquota** command removes any Limited Pass Volume size configured.

PTT Quota-Exhausted Limited Pass

Pending-Traffic-Treatment (PTT) Quota-Exhausted Limited-Pass in CUPS architecture is an alternative to the Buffering option. The Buffering option has practical limitations in the high-speed network. Buffering requires packet buffering for large number of packets at the gateway, causing the risk to run out of memory and affecting the bandwidth speed. The PTT Quota-Exhausted Limited Pass allows the traffic to pass through until it reaches the configured limit on the Quota-Exhaust scenarios.

The PTT allows the traffic until the Limited-Pass volume exhausts. The PTT counts and adjusts the usage in the respected charging-bucket against the granted "Quota". If the "Quota" allocation is less than the actual usage, there's immediate reporting towards OCS with the usage-report and asking for more quota allocation.

If the Limited-Pass Volume doesn't exhaust before the OCS responds with denial of quota, there's traffic blockage after the OCS response. Gateway reports the usage in CCR-U (FINAL).

If the Limited-Pass Volume exhausts before the OCS responds, then further incoming packets for the session are dropped until quota is granted from OCS.

The default behavior of pending-traffic-treatment for quota-exhausted is Drop. The default pending-traffic-treatment quota-exhausted CLI command removes any configured Limited-Pass Volume size.

Use the following CLI command to enable the feature:

```
configure
  active-charging service service_name
  credit-control
    pending-traffic-treatment quota-exhausted limited-pass volume volume
  end
```



Note The above CLI command is applicable only in CUPS architecture.

NOTES:

- **limited-pass**: Enables limited access to subscriber when OCS is unreachable.
- **volume volume**: Enables limited volume access to subscriber when OCS is unreachable. *volume* specifies the Default Quota size (in bytes) and must be an integer from 1 through 4294967295

Supported Functionality and Limitations

Basic call flow with Volume-Quota mechanism is supported with the following limitations on P-GW session reporting for Gy interface:

- Only CCR/CCA-I , CCR/CCA-U and CCR/CCA-T, RAR/RAA messages are supported.
- Dynamic Rules with Online Enabled is supported; both at Session-Setup and Mid-Session.
- Predefined Rules (dynamic-only) is supported; both at Session-Setup and Mid-Session. No restriction on configuring the "preemptively request".
- Static-rules with Online Charging are supported.
- Ignore-service-id is supported.
- Volume-Quota/Volume-Threshold mechanisms are supported.

- Event-Triggers (through which the Query URR occurs), and sending of usage information to the OCS is supported.



Important RAT-change functionality is not validated for this release.

- The "updateURR" procedure, through the Sx-Session-Modification procedure where the OCS grants a fresh Quota, is supported.
- Bearer-Level Gy and Subscriber-Level Gy is supported.
- Pending-Traffic-Treatment (PTT) Drop/Pass is supported with following limitations:
 - The scenarios supported for now are no-quota and quota-exhausted.
 - The trigger/re-authorization scenarios are not supported.
 - The PTT action (Forward/Drop) is considered after the quota-get is exhausted.
- Failure scenarios are qualified, which includes:
 - Failure-Handling Terminate, Continue and Retry, and Terminate: With CC-Group/FHT
 - Handling for the Error-Result-Codes (both at MSCC and Command level) is supported.
- Wall-Clock time-quota mechanism is supported.
- Other Time Quota Mechanisms (Discrete Time Period and Continuous-Time-Period) are not supported.
- Final-Unit-Indication Terminate mechanism is supported.
- FUI-Restrict is not supported.
- Mid-Session Rule Installation/Removal/Modification is supported.
- RAR mechanism is supported.
- Server-Unreachable (SU) mechanism is now supported with minor change in behavior compared to non-CUPS P-GW.
 - When an URR needs quota at UP, the usage-report is generated to CP and until the CP responds with the linked SU_URR, the packets matching this URR are treated with Pending-Traffic-Treatment configuration.
 - When the SU Time Quota is used and it's reported to CP for the Quota Exhaust, and if the session goes into Server-Unreachable state again, the time elapsed from the last Usage-Report is accounted in the usage.
- Pending-Traffic-Treatment Buffer mechanism is not supported.
- The "send-ccri on traffic-start" is supported.
- Quota-Hold-Time is supported.
- Quota-Consumption-Time mechanism is not supported.
- Quota-Validity-Time is supported.

- Triggering Gz records from Gy, when any event in Gy occurs, is supported; Gy-Gz sync is not supported.
- Triggering Rf records from Gy, when any event in Gy occurs, is not supported.
- Configuring different "rating-group" value other than the "content-id" is supported.
 - The RG 0 is not supported.
- Trigger to PCRF for the Out-of-Credit, Reallocation-of-Credit events are not qualified.



Important Event-trigger Out-of-Credit towards PCRF is validated with a limitation of having only one time Grant-Quota (Keeping Total Volume and Granted Volume at same value).

- The delayed response from OCS for the CCR-I is supported.
- Service-Specific-Units are not supported.
- Tariff-Time change is supported as per 3GPP specification.
- Quota-Retry Timer is supported.
- The **diameter mscc-final-unit-action terminate session** CLI command under Credit Control Configuration mode is supported.
- FUI-Redirect is supported with following limitations:
 - Redirection for HTTPs is not supported.
 - The FUI-Redirect with Filter-IDs/Filter-Rules are not supported.
 - The WSP Protocol is not supported.
 - In accordance with 3GPP specification, the Redirected-Traffic also gets redirected if it hits the rule that is in FUI-Redirect. There is no provision to allow the redirected-traffic to pass through.
 - In accordance with 3GPP specification, the CUPS architecture adheres to **no diameter fui-redirected-flow allow** CLI command behavior.
 - The **redirect-require-user-agent** CLI command is not supported; the redirection continues to work even if the user-agent is not present.
 - Appending the original URL is not supported.
 - The **diameter redirect-validity-timer immediate** CLI command is supported. However, **diameter redirect-validity-timer traffic-start** CLI command is not supported.
 - Token based mechanism, to come out of Redirection, is not supported. To end the redirection in CUPS, OCS sends Redirect Validity-Time or RAR.
 - FUI-Redirection is supported only for the URL, similar to the behavior in non-CUPS architecture.
- Rulebase change from PCRF/OCS is supported.

P-GW Session Reporting with Gz Interface

This section describes P-GW session reporting with Gz interface.

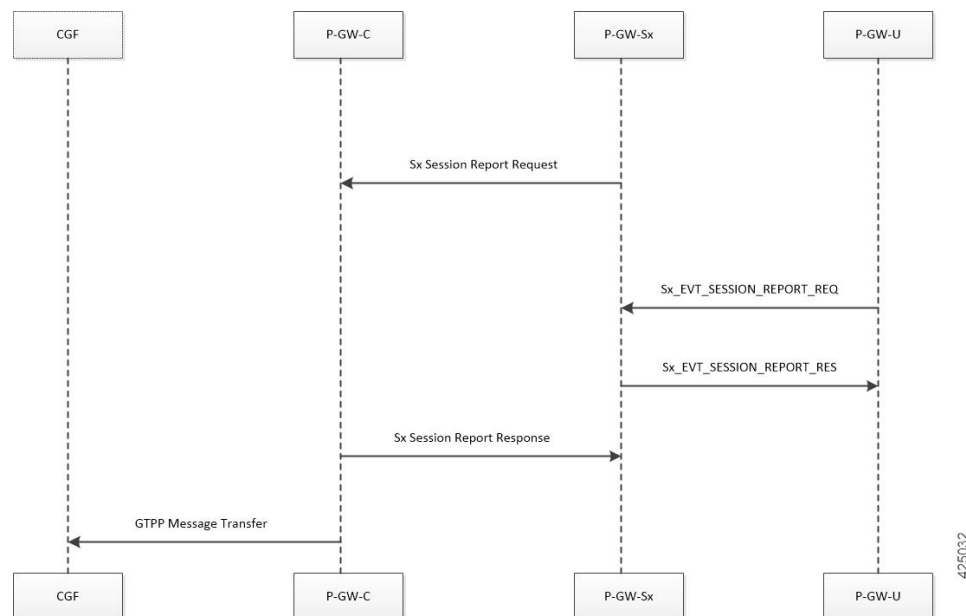

URR Processing in Detach Request

- The URR information will be sent by PGW User-Plane as part of Sx Session Delete Response.
- P-GW Control Plane maps these URRs to the corresponding charging buckets and then use the existing framework to send the charging records on the respective interfaces like Gz, Gy, and so on.

Sx Session Report Request Handling

P-GW User plane sends the Usage Report for triggers like Volume or Time-Threshold. P-GW Control Plane maps the URRs to the corresponding charging buckets.

URR Reporting Handling for Gz

URR reporting results in LOSDV bucket creation and P-GW CDR generation depending on the trigger sent by the P-GW User-Plane.

- If the bearer level URR is received, it results in generating the P-GW CDR for corresponding sub-session/bearer, along with reporting any existing LOSDV containers and the ones getting created as part of current report request. It is assumed that, when bearer level URR is received, User-Plane has sent all the SDF level URRs as well.
- When the SDF level URRs are received, they are stored as LOSDV containers. In this case the fbc_bucket is created with necessary counts or timestamps from the URR.

Standards Compliance

The Control Plane in CUPS complies with the following standards:

- 3GPP specification 23.214 release 14.0: Universal Mobile Telecommunications System (UMTS); LTE; Architecture enhancements for control and user plane separation of EPC nodes.
- 3GPP specification 29.244 release 14.0: LTE; Interface between the Control Plane and the User Plane of EPC Nodes.
- 3GPP specification 23.401 release 14.0: 3rd Generation Partnership Project; Technical Specification Group Services and System Aspects; General Packet Radio Service (GPRS) enhancements for Evolved Universal Terrestrial Radio Access Network (E-UTRAN) access.



CHAPTER 2

Configuring Control Plane in CUPS



Important For information related to following configurations, refer the *Ultra Packet Core CUPS Sx Interface Administration and Reference Guide*:

- *Configuring Sx Service for CUPS*
- *Configuring Sx-u Interface for CUPS*
- *Configuring Sx Demux for CUPS*



Important

- The following configuration limit applies in CUPS:
 - Rulebase - 512
 - Ruledef - 2500
 - Charging-action - 2048
- The following CLI command is not recommended to be used, with active subscriber sessions, in production environment: **no active-charging service** *service_name*

The SAEGW Service can be configured to support Control Plane in CUPS behavior, which provides Control Plane functionality through Sxa, Sxb, and Sxab interfaces. The following table highlights minimum configurations required for enabling CUPS Control Plane mode.

SAEGW Service Configuration Mode - Configuration Dependencies	Non-CUPS	CUPS (Control Plane)
cups-enabled	Not Required.	<p>eGTP-C Services of S-GW and P-GW must be associated with cups-enabled CLI to enable CUPS Control Plane Mode.</p> <p>Note Refer to the <i>Configuring SAEGW Service in CUPS Mode</i> section for configuration details.</p> <p>Important For GGSN, all eGTP-C services (of P-GW associated with GGSN service) and GGSN services should be configured with cups-enabled CLI command. For details, refer the <i>GGSN in CUPS</i> feature chapter.</p>
GTP-U Service (Under eGTP-C Service)	eGTP-C Services of S-GW and P-GW must be associated with GTP-U Service.	Not Required
Sx Service	Not Required.	<p>The SAEGW Service must be associated with Sx Service for communication with the User Plane. The Sx Service is capable of handling all possible interfaces like Sxa, Sxb, and Sxab, which is required for Pure-S, Pure-P, and Collapsed PDN respectively.</p> <p>Important Refer to the <i>Ultra Packet Core CUPS Sx Interface Administration and Reference Guide</i> for more details.</p>
GTP-U Service (Under SAEGW Service)	Not Required.	<p>The SAEGW Service must be associated with GTP-U Service for Sending/Receiving the Router Advertisement(RA)/Router Solicitation (RS) messages between Control Plane and User Plane. The RA/RS signaling is required for both IPv6 and IPv4v6 Pure-P/Collapsed PDN.</p> <p>Important Refer to the <i>Ultra Packet Core CUPS Sx Interface Administration and Reference Guide</i> for more details.</p>

- [Enabling CUPS in eGTP-C Service for SAEGW, on page 70](#)
- [Verifying CUPS in EGTPC Service for SAEGW, on page 71](#)
- [Recommended Timers, on page 72](#)

Enabling CUPS in eGTP-C Service for SAEGW

Use the following commands to configure eGTP-C service with CUPS mode that is applicable only for SAEGW service.

```

configure
  context context_name
    egtp-service service_name
      [ no ] cups-enabled
    end

```

The following services should be in STARTED state, and associated under SAEGW service for SAEGW service to move to STARTED state:

1. All eGTP-C services should be configured with **cups-enabled** CLI.
 - S-GW Ingress Service (which is configured as part of SAEGW S-GW Service)
 - S-GW Egress Service (which is configured as part of SAEGW S-GW Service)
 - P-GW Ingress Service (which is configured as part of SAEGW P-GW Service)
2. Other dependent Services like:
 - Sx Service
 - GTP-U Service

NOTES:

- There is no requirement to configure GTP-U service under eGTP-C service, in case **cups-enabled** CLI is enabled. If GTP-U service is configured along with **cups-enabled** CLI, then it will not have any affect.
- There is no change in non-CUPS behavior.
- Any deviation from the above mentioned configuration of SAEGW service will not get the Service in STARTED state. The same would be displayed in **show configuration errors** CLI command.
- The **show egtp-service all** for eGTP-C and **show saegw-service all** for SAEGW will display if the services are CUPS enabled.
- The **cups-enabled** CLI must not be used for standalone P-GW and S-GW service.

Verifying CUPS in EGTPC Service for SAEGW

You can use the following commands to verify if CUPS is enabled:

- **show configuration**
- **show configuration verbose**
- **show egtp-service { all | name *service_name* }**
- **show saegw-service { all | name *service_name* }**

Use the following command to verify the associated User Plane IP address:

- **show subscribers saegw-only full all**

Recommended Timers

The following table provides the recommended timer values for CLI commands related to IPsec, Sx, and SRP.

IPSEC	CP	UP
ikev2-ikesa max-retransmission	3	3
ikev2-ikesa retransmission-timeout	1000	1000
keepalive	interval 4 timeout 1 num-retry 4	interval 5 timeout 2 num-retry 4
Sx	CP	UP
sx-protocol heartbeat interval	10	10
sx-protocol heartbeat retransmission-timeout	5	5
sx-protocol heartbeat max-retransmissions	4	4
sxa max-retransmissions	4	4
sxa retransmission-timeout-ms	5000	5000
sxb max-retransmissions	4	4
sxb retransmission-timeout-ms	5000	5000
sxab max-retransmissions	4	4
sxab retransmission-timeout-ms	5000	5000
sx-protocol association reattempt-timeout	60	60
SRP	CP	UP
hello-interval	3	3
dead-interval	15	15

Recommended Configurations

Following are the recommended configurations and restrictions related to Sx and SRP over IPsec:

- The multihop BFD timer between CP and UP must be seven seconds (for Data UPs).
- The singlehop BFD must be enabled on all the contexts (CP GW/Billing and UP Gn/Gi).
- Inter-chassis multihop BFD must be enabled for CP-CP ICSR and UP-UP ICSR (IMS UP).
- The SRP-IPsec ACL must be configured for TCP protocol instead of IP protocol.

- The Sx-IPSec ACL must be configured for UDP protocol instead of IP protocol.

Example Configurations in CP

Multihop BFD Configuration VPC-DI

The following is an example of multihop BFD configuration with seven seconds timer.

```
bfd-protocol
  bfd multihop-peer 209.165.200.226 interval 350 min_rx 350 multiplier 20
  bfd multihop-peer 209.165.200.227 interval 350 min_rx 350 multiplier 20
  bfd multihop-peer 209.165.200.225 interval 350 min_rx 350 multiplier 20
  bfd multihop-peer 209.165.200.230 interval 350 min_rx 350 multiplier 20
  bfd multihop-peer 209.165.200.228 interval 350 min_rx 350 multiplier 20
  bfd multihop-peer 209.165.200.229 interval 350 min_rx 350 multiplier 20
#exit
```

Multihop BFD Configuration VPC-SI

The following is an example of multihop BFD configuration with three seconds timer.

```
bfd-protocol
  bfd multihop-peer 209.165.200.226 interval 150 min_rx 150 multiplier 20
  bfd multihop-peer 209.165.200.227 interval 150 min_rx 150 multiplier 20
  bfd multihop-peer 209.165.200.225 interval 150 min_rx 150 multiplier 20
  bfd multihop-peer 209.165.200.230 interval 150 min_rx 150 multiplier 20
  bfd multihop-peer 209.165.200.228 interval 150 min_rx 150 multiplier 20
  bfd multihop-peer 209.165.200.229 interval 150 min_rx 150 multiplier 20
#exit
```

BGP Configuration

The following is an example of BGP configuration with recommended timers.

```
router bgp 1111
  router-id 209.165.200.225
  maximum-paths ebgp 15
  neighbor 209.165.200.250 remote-as 1000
  neighbor 209.165.200.250 ebgp-multihop
  neighbor 209.165.200.250 update-source 209.165.200.225
  neighbor 1111:2222::101 remote-as 1000
  neighbor 1111:2222::101 ebgp-multihop
  neighbor 1111:2222::101 update-source 1111:2222::1
  bgp graceful-restart restart-time 120
  bgp graceful-restart stalepath-time 300
  timers bgp keepalive-interval 30 holdtime-interval 90 min-peer-holdtime-interval 0
server-sock-open-delay-period 10
  address-family ipv4
    redistribute connected
  #exit
  address-family ipv6
    neighbor 1111:2222::101 activate
    redistribute connected
  #exit
#exit
```

Singlehop BFD Configuration

The following is an example of singlehop BFD configuration with three seconds timer.

```
interface bgp-sw1-2161-10
  ip address 209.165.200.233 209.165.200.255
```

```

    ipv6 address 1111:222::9/112 secondary
    bfd interval 999 min_rx 999 multiplier 3
#exit
interface bgp-sw1-2161-11
    ip address 209.165.200.234 209.165.200.255
    ipv6 address 1111:222::10/112 secondary
    bfd interval 999 min_rx 999 multiplier 3
#exit
interface bgp-sw1-2161-12
    ip address 209.165.200.235 209.165.200.255
    ipv6 address 1111:222::11/112 secondary
    bfd interval 999 min_rx 999 multiplier 3
#exit
interface bgp-sw1-2161-3
    ip address 209.165.200.226 209.165.200.255
    ipv6 address 1111:222::2/112 secondary
    bfd interval 999 min_rx 999 multiplier 3
#exit
interface bgp-sw1-2161-4
    ip address 209.165.200.227 209.165.200.255
    ipv6 address 1111:222::3/112 secondary
    bfd interval 999 min_rx 999 multiplier 3
#exit
interface bgp-sw1-2161-5
    ip address 209.165.200.228 209.165.200.255
    ipv6 address 1111:222::4/112 secondary
    bfd interval 999 min_rx 999 multiplier 3
#exit
interface bgp-sw1-2161-6
    ip address 209.165.200.229 209.165.200.255
    ipv6 address 1111:222::5/112 secondary
    bfd interval 999 min_rx 999 multiplier 3
#exit
interface bgp-sw1-2161-7
    ip address 209.165.200.230 209.165.200.255
    ipv6 address 1111:222::6/112 secondary
    bfd interval 999 min_rx 999 multiplier 3
#exit
interface bgp-sw1-2161-8
    ip address 209.165.200.231 209.165.200.255
    ipv6 address 1111:222::7/112 secondary
    bfd interval 999 min_rx 999 multiplier 3
#exit
interface bgp-sw1-2161-9
    ip address 209.165.200.232 209.165.200.255
    ipv6 address 1111:222::8/112 secondary
    bfd interval 999 min_rx 999 multiplier 3
#exit

```

Static Route for Multihop BFD Configuration

The following is an example of static route multihop BFD configuration.

```

ip route static multihop bfd UP-5 209.165.200.240 209.165.200.245
ip route static multihop bfd UP-6 209.165.200.240 209.165.200.246
ip route static multihop bfd UP-9 209.165.200.240 209.165.200.247
ip route static multihop bfd UP-10 209.165.200.240 209.165.200.248
ip route static multihop bfd UP-7 209.165.200.240 209.165.200.249
ip route static multihop bfd UP-8 209.165.200.240 209.165.200.250

```

Static Route for Singlehop BFD Configuration

The following is an example of static route singlehop BFD configuration.

```

ip route static bfd bgp-sw1-2161-3 209.165.200.230
ip route static bfd bgp-sw1-2161-4 209.165.200.230
ip route static bfd bgp-sw1-2161-5 209.165.200.230
ip route static bfd bgp-sw1-2161-6 209.165.200.230
ip route static bfd bgp-sw1-2161-7 209.165.200.230
ip route static bfd bgp-sw1-2161-8 209.165.200.230
ip route static bfd bgp-sw1-2161-9 209.165.200.230
ip route static bfd bgp-sw1-2161-10 209.165.200.230
ip route static bfd bgp-sw1-2161-11 209.165.200.230
ip route static bfd bgp-sw1-2161-12 209.165.200.230

```

IPSec ACL Configuration

The following is an example IPSec ACL configuration in CP.

```

ip access-list UP-1
    permit udp host 209.165.200.225 host 209.165.200.226
#exit

```

IPSec Transform Set Configuration

The following is an example of IPSec Transform Set configuration in CP.

```

ikev2-ikesa transform-set ikesa-UP-1
    encryption aes-cbc-256
    group 14
    hmac sha2-256-128
    lifetime 28800
    prf sha2-256

ipsec transform-set A-UP-1
    encryption aes-cbc-256
    hmac sha2-256-128
    group 14

```

IPSec Crypto Map Configuration

The following is an example of IPSec Crypto Map configuration in CP.

```

crypto map UP-1 ikev2-ipv4
    match address UP-1
    authentication local pre-shared-key encrypted key secretkey
    authentication remote pre-shared-key encrypted key secretkey
    ikev2-ikesa max-retransmission 3
    ikev2-ikesa retransmission-timeout 1000
    ikev2-ikesa transform-set list ikesa-UP-1
    ikev2-ikesa rekey
    keepalive interval 4 timeout 1 num-retry 4
    control-dont-fragment clear-bit
    payload foo-sa0 match ipv4
        ipsec transform-set list A-UP-1
        lifetime 300
        rekey keepalive
    #exit
    peer 192.1.1.1
    ikev2-ikesa policy error-notification
#exit

```

Sx Configuration

The following is an example of Sx configuration in CP.

```

sx-service SX-1
    instance-type controlplane

```

```

sxa max-retransmissions 4
sxa retransmission-timeout-ms 5000
sxb max-retransmissions 4
sxb retransmission-timeout-ms 5000
sxab max-retransmissions 4
sxab retransmission-timeout-ms 5000
n4 max-retransmissions 4
n4 retransmission-timeout-ms 5000
sx-protocol heartbeat interval 10
sx-protocol heartbeat retransmission-timeout 5
sx-protocol heartbeat max-retransmissions 4
sx-protocol compression
sx-protocol supported-features load-control
sx-protocol supported-features overload-control
exit
end

```

Example Router Configurations

Static Routes for Interface

The following is an example configuration of static route for interface.

```

ip route 209.165.200.224/27 Vlan1111 209.165.200.225
ip route 209.165.200.224/27 Vlan1111 209.165.200.226
ip route 209.165.200.224/27 Vlan1111 209.165.200.227
ip route 209.165.200.224/27 Vlan1111 209.165.200.228
ip route 209.165.200.224/27 Vlan1111 209.165.200.229
ip route 209.165.200.224/27 Vlan1111 209.165.200.230
ip route 209.165.200.224/27 Vlan1111 209.165.200.231
ip route 209.165.200.224/27 Vlan1111 209.165.200.232
ip route 209.165.200.224/27 Vlan1111 209.165.200.233
ip route 209.165.200.224/27 Vlan1111 209.165.200.234

```

Static Routes for Singlehop BFD

The following is an example configuration of static route for singlehop BFD.

```

ip route static bfd Vlan1111 209.165.200.225
ip route static bfd Vlan1111 209.165.200.226
ip route static bfd Vlan1111 209.165.200.227
ip route static bfd Vlan1111 209.165.200.228
ip route static bfd Vlan1111 209.165.200.229
ip route static bfd Vlan1111 209.165.200.230
ip route static bfd Vlan1111 209.165.200.231
ip route static bfd Vlan1111 209.165.200.232
ip route static bfd Vlan1111 209.165.200.233
ip route static bfd Vlan1111 209.165.200.234

```

Interface for Singlehop BFD

The following is an example configuration of interface for singlehop BFD.

```

interface Vlan1111
  no shutdown
  bandwidth 10000000
  bfd interval 999 min_rx 999 multiplier 3
  no bfd echo
  ip address 209.165.200.224/27
  ipv6 address 1111:222::1/112

```

BGP Configuration

The following is an example of BGP configuration with recommended timers.

```
router bgp 1000
  router-id 209.165.200.226
  timers bgp 30 90
  timers bestpath-limit 300
  timers prefix-peer-timeout 30
  timers prefix-peer-wait 90
  graceful-restart
  graceful-restart restart-time 120
  graceful-restart stalepath-time 300
```

Example Configurations in UP

IPSec ACL Configuration

The following is an example of IPSec ACL configuration in UP.

```
ip access-list CP-1
  permit udp host 209.165.200.225 host 209.165.200.226
  #exit
```

IPSec Transform Set Configuration

The following is an example of IPSec Transform Set configuration in UP.

```
ipsec transform-set A-CP-1
  encryption aes-cbc-256
  hmac sha2-256-128
  group 14

ikev2-ikesa transform-set ikesa-CP-1
  encryption aes-cbc-256
  group 14
  hmac sha2-256-128
  lifetime 28800
  prf sha2-256
```

IPSec Crypto Map Configuration

The following is an example of IPSec Crypto Map configuration in UP.

```
crypto map CP-1 ikev2-ipv4
  match address CP-1
  authentication local pre-shared-key encrypted key secretkey
  authentication remote pre-shared-key encrypted key secretkey
  ikev2-ikesa max-retransmission 3
  ikev2-ikesa retransmission-timeout 1000
  ikev2-ikesa transform-set list ikesa-CP-1
  ikev2-ikesa rekey
  keepalive interval 5 timeout 2 num-retry 4
  control-dont-fragment clear-bit
  payload foo-sa0 match ipv4
  ipsec transform-set list A-CP-1
  #exit
  peer 209.165.200.230
  ikev2-ikesa policy error-notification
  #exit
```

Sx Configuration

The following is an example of Sx configuration in UP.

```

sx-service SX-1
  instance-type userplane
  sxa max-retransmissions 4
  sxa retransmission-timeout-ms 5000
  sxb max-retransmissions 4
  sxb retransmission-timeout-ms 5000
  sxab max-retransmissions 4
  sxab retransmission-timeout-ms 5000
  n4 max-retransmissions 4
  n4 retransmission-timeout-ms 5000
  sx-protocol heartbeat interval 10
  sx-protocol heartbeat retransmission-timeout 5
  sx-protocol heartbeat max-retransmissions 4
  sx-protocol compression
exit

```

Example SRP Configurations

IPSec ACL Configuration

The following is an example of IPSec ACL configuration for SRP.

```

ip access-list SRP
  permit tcp host 209.165.200.227 host 209.165.200.228
#exit

```

SRP Configuration

The following is an example of SRP configuration.

```

configure
context srp
  bfd-protocol
    bfd multihop-peer 209.165.200.225 interval 999 min_rx 999 multiplier 3
  #exit
configure
context srp
  service-redundancy-protocol
    chassis-mode primary
    hello-interval 3
    dead-interval 15
    monitor bfd context srp 209.165.200.226 chassis-to-chassis
    monitor bgp context gi-pgw 209.165.200.245
    monitor bgp context gi-pgw 3333:888::1
    monitor bgp context saegw 209.165.200.245
    monitor bgp context saegw 3333:888::2
    peer-ip-address 209.165.200.227
    bind address 209.165.200.228
  #exit
ip route static multihop bfd srp 209.165.200.229 209.165.200.245
ip route 209.165.201.1 209.165.202.129 209.165.200.230 SRP-Physical-2102
ip route 209.165.201.2 209.165.202.130 209.165.200.231 SRP-Physical-2102
ip route 209.165.201.3 209.165.202.131 209.165.200.232 SRP-Physical-2102
ip igmp profile default
#exit
#exit
end

```



CHAPTER 3

Monitoring and Troubleshooting Control Plane in CUPS

This section provides information about the CLI commands available to monitor and/or troubleshoot Control Plane in CUPS.

- [Show Command\(s\) and/or Outputs, on page 79](#)
- [SNMP Support, on page 85](#)
- [Monitoring and Troubleshooting SAEGW Service in CUPS Mode, on page 85](#)
- [Change in Idle Time Value in Control Plane, on page 88](#)

Show Command(s) and/or Outputs

show subscribers control-plane-only all

This command displays the following Control Plane specific information for the session. Following is a sample output:

- Access Type
 - (R) - sgw-pdn-type-ipv4
 - (O) - sgw-pdn-type-ipv6
 - (Q) - sgw-pdn-type-ipv4-ipv6
 - (@) - saegw-gtp-ipv4
 - (#) - saegw-gtp-ipv6
 - (\$) - saegw-gtp-ipv4-ipv6
 - (W) - pgw-gtp-ipv4
 - (Y) - pgw-gtp-ipv6
 - (Z) - pgw-gtp-ipv4-ipv6
 - (.) – Unknown

- Access Tech
 - (U) - UTRAN
 - (G) - GERAN
 - (E) - eUTRAN
 - (.) - Unknown
- Call State
 - (C) - Connected
 - (c) - Connecting
 - (S) - Suspended
 - (d) - Disconnecting
 - (I) - Idle
 - (u) - Unknown
- Bearer Type
 - (D) - Default
 - (E) - Dedicated
 - (I) - Indirect Forwarding
- PLMN
 - (H) - Home
 - (V) – Visiting
 - (R) - Roaming
 - (u) - Unknown
- Emergency Bearer Type
 - (A) - Authentic IMSI
 - (U) - Un-Authentic IMSI
 - (O) - Only IMEI
 - (N) - Non-Emergency
- Addr
 - (L) - Local pool
 - (S) - Static (Subscriber Supplied)
 - Type: (u) - Unknown

- CALLID
- LOCAL SEID
- IMSI/IMEI
- EBI
- V
- IP
- PDN-INSTANCE
- User Plane Address
- TIME-IDLE

**Note**

- Only all keyword is supported after **control-plane-only** keyword.
- Bearer-type supported is default.
- Valid Access Technology populated is eUTRAN for now.

show session disconnect-reasons

The following disconnect reasons has been added in support of Control Plane in CUPS:

- user-plane-info-not-available(651)

This disconnect reason is seen in following conditions:

- **user-plane-profile** is not associated with APN Profile for Pure-S call.
- **user-plane-profile** is not associated with IP Pool for Pure-P call.
- Associated **user-plane-profile** is not configured.
- Associated **user-plane-profile** is not configured with endpoint address

- user-plane-info-mismatch(652)

- For multiple PDN call with same APN, and for IPv4 and IPv6 call, it is mandatory that same User Plane profile is selected. Any variation will result in call creation failure with this disconnect reason.

- sx-max-trans-threshold-reached(676): Calls are dropped with this disconnect reason if the outstanding Sx transaction exceeds 12.

show subscribers saegw-only full all

Executing this command displays the following fields:

- User Plane Address

- Local SEID
- Remote SEID

show subscribers saegw-only seid *seid_value*

Executing this command displays the following fields:

- vvvvvv
- CALL ID
- IMSI/IMEI
- EBI
- v
- IP
- APN
- TIME-IDLE

show user-plane-service statistics charging action

This command displays charging action statistics for all or specified charging actions that are configured in the Active Charging Service (ACS). A charging action represents actions to be taken when a configured rule is matched. Actions range from generating accounting records to dropping the IP packet, and so on. The charging action also determines the metering principle—Whether to count retransmitted packets, and which protocol field to use for billing (L3/L4/L7, and so on).

Syntax

```
show user-plane-service statistics charging-action
{ all [ debug-info | verbose ] | name charging_action_name [ debug-info |
verbose ] } [ | { grep grep_options | more } ]
```

Notes:

- **all**: Displays information for all charging actions configured in ACS.
- **name *charging_action_name***: Displays information for an existing charging action specified as an alphanumeric string from 1 through 63 characters.

This show CLI command doesn't support the following statistics with the value 0 that is displayed for each of its counter value.

```
PP Flows Readdressed:0
Bytes Charged Yet Packet Dropped:0
Predef-Rules Deactivated:0
Outer IP header dscp marked Pkts:0
```

Tethering Blocking Statistics:

TTL Modified downlink packets:0

Throttle-Suppress Stats:

Uplink Bytes:0 Downlink Bytes:0

XHeader Information:

IP Frags consumed by XHeader:0 IP Frags consumed by XHeader:0

Strip URL:

Successful Token stripped:0
Total strip URL failure:0
Failure - Missing config:0
Failure - Existing flow bid:0
Failure - Token matching failed:0
Failure - Empty packet:0
Failure - Req end not found:0
Failure - Subset of big token:0

URL-Readdressing:

Requests URL-Readdressed:0
Total Charging action hit - Req. Readdr.:0
Proxy Disable Success:0
Flows connected to URL Server:0

URL-Readdressing Error Conditions:

Total connect failed to URL Server:0
URL Readdress- pipelined case:0
URL Readdress- Socket Mig. Failed:0
Proxy Disable Failed:0

CAE-Readdressing:

Requests CAE-Readdressed:0
Responses CAE-Readdressed:0
Requests having MVG xheader inserted:0
Total CAE-Readdressed Uplink Bytes:0
Total CAE-Readdressed Uplink Packets:0
Total CAE-Readdressed Downlink Bytes:0
Total CAE-Readdressed Downlink Packets:0
Total Charging action hit - Req. Readdr.:0
Total Charging action hit - Resp. Readdr:0
Proxy Disable Success:0
Flows connected to CAE:0

CAE Readdressing Error Conditions:

Total connect failed to CAE:0
Req. Readdr. - pipelined case:0
Skipped Resp. Readdr. - pipelined req:0

```

Req. Readdr. - Socket Mig. failed:0
Skipped Resp. Readdr. - partial resp hdr:0
Resp. Readdr. - Socket Mig. failed:0
Total CAE load balancer failed:0
Total MVG xheader insertion failed:0
Proxy Disable Failed:0

Rulebase Changed by flow action:0
Terminate Session:0
P2P random dropped packets:0

```

show user-plane-service statistics group-of-ruledefs

This command displays statistics for all groups or a specified group of **ruledefs** configured in the active charging service. The **group-of-ruledefs** is a collection of rule definitions that can be used in access policy creation.

Syntax

```

show user-plane-service statistics group-of-ruledefs { all | name
group_of_ruledefs_name } [ | { grep grep_options | more } ]

```

Notes:

- **all**: Displays information for all **groups of ruledefs** configured in ACS.
- **name group_of_ruledefs_name**: Displays detailed information for an existing **group of ruledefs** specified as an alphanumeric string from 1 through 63 characters.
- **{ grep grep_options | more } Pipes**: Sends the output of this command to the specified command.
- The following clear CLI command is available for use:

```

clear user-plane-service statistics group-of-ruledefs { all | name
group_of_ruledefs_name }

```

show user-plane-service statistics ruledef

This command displays statistics for all or specified **ruledef** that is configured in an active charging service. The **ruledef** represents a set of matching conditions across multiple L3 - L7 protocol that is based on protocol fields and state information. You can use each **ruledef** across multiple rule bases within the active charging service.

Syntax

```

show user-plane-service statistics ruledef { all { charging | firewall [
wide ] | post-processing } | name ruledef_name [ wide ] } [ | { grep
grep_options | more } ]

```

Notes:

- **all**: Displays statistics for **all ruledefs** of the specified type that is configured in the ACS.
- **charging**: Displays statistics for all **charging ruledefs** configured in the ACS.

- **firewall**: Displays statistics for all **firewall ruledefs** configured in the service.
- **post processing**: Displays statistics for all **post processing ruledefs** configured in the ACS.
- **name ruledef_name**: Displays statistics for an existing **ruledef** specified as an alphanumeric string from 1 through 63 characters.
- **wide**: Displays all available information in a single wide line.
- The following clear CLI command is available for use:

```
clear user-plane-service statistics ruledef { all | charging | firewall
| name group_of_ruledefs_name }
```

SNMP Support

The system uses the Simple Network Management Protocol (SNMP) to send traps or events to the EMS server or an alarm server on the network. You must configure SNMP settings to communicate with those devices.

For more details about configuring SNMP and Alarm Server Parameters, refer to the *Management Settings* chapter in either the *VPC-DI System Administration Guide* or the *VPC-SI System Administration Guide*.



Note The **snmp engine-id local** command is mandatory if your network requires SNMP v3 support. The engine ID uniquely identifies the SNMP engine and associated SNMP entities, thus providing a security association between the two for the sending and receiving of data.

Monitoring and Troubleshooting SAEGW Service in CUPS Mode

This section provides information about the CLI commands available to monitor and/or troubleshoot SAEGW service in CUPS mode.

Show Command(s) and/or Outputs

show configuration errors

Following are the error messages that are added in support of CUPS in eGTPC service for SAEGW:

1. If neither **cups-enabled** nor **gtpu-service** is associated in eGTPC Service:

```
#####
                                     Displaying EGTP-Service system errors
#####
Error : No GTPU service is associated with EGTP service <service_name> in the context
       <context_name>.
Total 1 error(s) in this section !
```

2. If eGTPC S-GW Egress Service is not associated with S-GW Service:

```
#####
```

```

          Displaying EGTP-Service system errors
#####
Error : Egress EGTP service not configured for SGW service <service_name> in the context
       <context_name>.
Total 1 error(s) in this section !

```



Note This error will be displayed only if S-GW Ingress service is configured and cups-enabled is configured in it.

3. If eGTPC S-GW Ingress Service is **cups-enabled** and eGTPC S-GW Egress Service is not **cups-enabled**:

```

#####
          Displaying SGW-Service system errors
#####
Error : Both Ingress EGTP service <service_name> and Ingress EGTP service <service_name>
       must be configured in either CUPS mode or Non-CUPS Mode
Total 1 error(s) in this section !

```

4. If eGTPC S-GW Egress Service is **cups-enabled** and eGTPC S-GW Ingress Service is not **cups-enabled**:

```

#####
          Displaying SGW-Service system errors
#####
Error : Both Ingress EGTP service <service_name> and Ingress EGTP service <service_name>
       must be configured in either CUPS mode or Non-CUPS Mode
Total 1 error(s) in this section !

```

5. If P-GW and/or S-GW Service in SAEGW Service is **cups-enabled** and Sx Service associated in SAEGW Service is not present in system:

```

#####
          Displaying SAEGW-Service system errors
#####
Error : SX service <service_name> configured for SAEGW service <service_name> in the
       context <context_name> is not present in the system.
Total 1 error(s) in this section !

```

6. If P-GW and/or S-GW Service in SAEGW Service is **cups-enabled** and Sx Service associated in SAEGW Service is not STARTED

```

#####
          Displaying SAEGW-Service system errors
#####
Error : SX service <service_name> configured for SAEGW service <service_name> in the
       context <context_name> is not started.
Total 1 error(s) in this section !

```

7. SAEGW Service is **cups-enabled** and Sx Service is not associated in SAEGW Service:

```

#####
          Displaying SAEGW-Service system errors
#####
Error : SX service not configured for SAEGW service <service_name> in the context
       <context_name>.
Total 1 error(s) in this section !

```

8. If P-GW and/or S-GW Service in SAEGW Service is **cups-enabled** and GTP-U Service associated in SAEGW Service is not present in system:

```
#####
                Displaying SAEGW-Service system errors
#####
Error : GTPU service <service_name> configured for SAEGW service <service_name> in the
context <context_name> is not present in the system.
Total 1 error(s) in this section !
```

9. If P-GW and/or S-GW Service in SAEGW Service is **cups-enabled** and GTP-U Service associated in SAEGW Service is not STARTED:

```
#####
                Displaying SAEGW-Service system errors
#####
Error : GTPU service <service_name> configured for SAEGW service <service_name> in the
context <context_name> is not started.
Total 1 error(s) in this section !
```

10. If P-GW and/or S-GW Service in SAEGW Service is **cups-enabled** and GTP-U Service is not associated in SAEGW Service:

```
#####
                Displaying SAEGW-Service system errors
#####
Error : GTPU service not configured for SAEGW service <service_name> in the context
<context_name>.
Total 1 error(s) in this section !
```

11. If P-GW Service in SAEGW Service is **cups-enabled** but S-GW Service is not cups-enabled:

```
#####
                Displaying SAEGW-Service system errors
#####
Error : Both SGW service <service_name> and PGW service <service_name> must be configured
in either CUPS mode or Non-CUPS Mode.
Total 1 error(s) in this section !
```

12. If S-GW Service in SAEGW Service is cups-enabled but P-GW Service is not **cups-enabled**:

```
#####
                Displaying SAEGW-Service system errors
#####
Error : Both SGW service <service_name> and PGW service <service_name> must be configured
in either CUPS mode or Non-CUPS Mode.
Total 1 error(s) in this section !
```

Support for the Additional User Plane Attributes - UP Group Name and UP Node-ID

The following CUPS CLI show commands are modified to support the additional User Plane attributes. Now, the show command displays the UP-GROUP-NAME and UP-NODE-ID in the show subscriber output.

- **show subscribers saegw-only all**
- **show subscribers saegw-only apn <apn_name>**
- **show subscribers saegw-only imsi <imsi_id>**
- **show subscribers saegw-only callid <call_id>**
- **show subscribers saegw-only ebi <ebi_value>**

- `show subscribers saegw-only msid <ms_id>`
- `show subscribers saegw-only qci <qci_value>`
- `show subscribers ggsn-only all`
- `show subscribers ggsn-only apn <apn_name>`
- `show subscribers ggsn-only imsi <imsi_id>`
- `show subscribers ggsn -only callid <call_id>`
- `show subscribers ggsn-only ebi <ebi_value>`
- `show subscribers ggsn-only msid <ms_id>`
- `show subscribers ggsn-only qci <qci_value>`
- `show subscribers saegw-only full imsi <imsi_id>`
- `show subscribers saegw-only full apn <apn_name>`
- `show subscribers saegw-only full callid <call_id>`
- `show subscribers saegw-only full ebi <ebi_value>`
- `show subscribers saegw-only full msid <ms_id>`
- `show subscribers saegw-only full qci <qci_value>`
- `show subscribers ggsn-only full all`
- `show subscribers ggsn-only full imsi <imsi_id>`
- `show subscribers ggsn-only full apn <apn_name>`
- `show subscribers ggsn-only full callid <call_id>`
- `show subscribers ggsn-only full ebi <ebi_value>`
- `show subscribers ggsn-only full msid <ms_id>`
- `show subscribers ggsn-only full qci <qci_value>`
- `show subscribers control-plane-only all`

Change in Idle Time Value in Control Plane

In 21.22.2 and later releases, the output of the following show CLI command has been modified to display the Time-Idle/idle time left value as n/a.

- `show sub all`
- `show sub saegw-only all`
- `show subscribers saegw-only full all`
- `show sub full`

- show sub full all



CHAPTER 4

5G NSA for SAEGW in CUPS

- [Feature Description, on page 91](#)

Feature Description

Cisco 5G Non Standalone (NSA) solution leverages the existing LTE radio access and core network (EPC) as an anchor for mobility management and coverage. This solution enables operators using the Cisco EPC Packet Core to launch 5G services in shorter time and leverage existing infrastructure. Thus, NSA provides a seamless option to deploy 5G services with very less disruption in the network.

5G is the next generation of 3GPP technology, after 4G/LTE, defined for wireless mobile data communication. The 5G standards are introduced in 3GPP Release 15 to cater to the needs of 5G networks.

5G Non Standalone (NSA): The existing LTE radio access and core network (EPC) is leveraged to anchor the 5G NR using the Dual Connectivity feature. This solution enables operators to provide 5G services with shorter time and lesser cost.

Limitation

- In CUPS architecture, the SGW-C/PGW-C selecting SGW-U/PGW-U based on DCNR is not supported in this release.
- In this release, APNMBR rate-limit configuration is not supported. The APNMBR policer uses Auto-readjust internally.

For more information on limitations, refer to the *5G NSA for SAEGW* chapter in the *5G Non Standalone Solution Guide*

For additional information about 5G NSA for SAEGW, refer the *5G NSA for SAEGW* chapter in the *5G Non Standalone Solution Guide*.



CHAPTER 5

ADC Over Gx

- [Feature Description, on page 93](#)
- [How It Works, on page 94](#)
- [Configuring ADC over Gx, on page 96](#)
- [Monitoring and Troubleshooting, on page 96](#)

Feature Description

In compliance with 3GPP TS 29.244 V15.0.0, ADC over Gx feature supports the following functionalities in CUPS environment:

- Application START/STOP event reporting at the instance level, over the Sx Interface, as part of the session usage report request.
- Application START/STOP is sent for Group of Ruledef when a flow matches the Group of Ruledef.
- Supports AND logic for rulelines while matching ADC ruledefs.
- Supports new Information Elements (IEs) for Packet Forwarding Control Protocol (PFCP) messages that are used for ADC application detection notifications.



Important In this release, the ADC Over Gx feature is applicable for ADC L3/L4 rules.



Important For supplemental information about ADC Over Gx feature in non-CUPS environment, refer to:

- *ADC Support over Gx* section in the *Application Detection and Control Overview* chapter of the *ADC Administration Guide*.
- *Support ADC Rules over Gx Interface* section in the *Gx Interface Support* chapter of the *P-GW Administration Guide*.

How It Works

For ADC over Gx feature in the CUPS environment, support is added for the following:

- The Application ID/TDF Application Identifier is part of the PDI of PDR, either in Sx Establishment Request or Sx Session Modify Request.
- Handling of the ADC rule match on U-Plane.
- To generate a session usage report request when the Application START/STOP event occurs on U-Plane.
- New IEs as part of the Usage report request:
 - Application ID
 - Application Instance ID
 - Flow Information
- Monitor Protocol to decode the new IEs.
- To handle the usage report request that is received, and trigger the CCR-U to PCRF on C-Plane.

The functionality of ADC Over Gx feature consists of the following components, and each are described in this section.

ADC Rule Match

The ADC rule match is invoked after the traditional rule match. After the L3/L4 filters are being matched, the rule match engine checks for any ADC rules being configured on the bearer. If ADC rules are present, then the ADC rule match occurs.

If the bearer has ADC rule which does not have the L3/L4 filters, and it's a non-GBR bearer, then the ADC rule match is done across all the non-GBR bearers. The charging is done against the charging and action policy of the rule match.

For ADC dynamic rules, if the L3/L4 filter matches but the ADC rule match fails, then the rule is considered as not matched.

Session Usage Report Request Generation

Once the ADC rule matches on the U-Plane and an application has been detected, the U-Plane triggers the Application START notification over the Sx interface as a session usage report:

- With the measurement method set to Event
- Usage Report Trigger set to "Start of Traffic"
- The Application Detection Info, such as Application ID, Application Instance ID, and Application Flow Information along with the direction.

When the application teardown gracefully, the application gets timed out, or the rule match changes, the application STOP is triggered from U-Plane to C-Plane as a session usage report:

- With the measurement method set to "Event"

- Usage Report Trigger set to “Stop of Traffic”
- Application ID
- Application Instance ID

The application STOP is not triggered when:

- “mute” is enabled.
- The call is going down.
- The rule/PDR is deleted.
- The bearer/tunnel deletion occurs.

Handling Session Usage Report on C-Plane

After receiving the session usage report on C-Plane, it detects the event and CCR-U is triggered toward PCRF, along with the required attributes to be sent.

Dynamic HTTP Redirect

Redirection rules and actions that are received over Gx are part of RAR and CCA-U messages in a dynamic rule. CUPS supports redirection rules and actions to be conveyed from C-Plane to U-Plane and applied to U-Plane. The following fields are translated and sent to U-Plane and U-Plane redirects accordingly:

```
[V] Redirect-Information:
  [V] Redirect-Support:
  [M] Redirect-Address-Type:
  [M] Redirect-Server-Address:
```

In C-Plane:

- FAR, associated with PDR, is populated to support "Redirect-Information" AVP in ADC dynamic rule over Gx.
- PDR and FAR are sent with the "Redirect Information" IE to U-Plane in:
 - Sx Session Establishment Request in case "Redirect-Information" AVP is received in an ADC dynamic rule over Gx in CCA-I from PCRF.
 - Sx Session Modification Request in case "Redirect-Information" AVP is received in an ADC dynamic rule over Gx in CCA-U from PCRF.
 - Sx Session Modification Request in case "Redirect-Information" AVP is received in an ADC dynamic rule over Gx in RAR from PCRF.
- Support is added for removal of ADC dynamic rule.

In U-Plane:

- ADC dynamic rule for the subscriber is installed.
- The packet is redirected if ADC dynamic rule is matched.

Limitations

Following are the known limitations of the ADC Over Gx feature:

- When the TDF Application Identifier on the U-Plane and the “**policy-control bypass TDF-ID-validation** CLI command are not present, the calls are dropped. And, the proper disconnect reason is not being shown.
- The configuration change for predefined ADC rules, such as "mute" to "unmute" and "unmute" to "mute" scenarios are not supported in this release.
- Mid-session update and/or modification of ADC rules—whether change in configuration or PDN update over RAR, is not supported.
- ADC is supported for L3/L4 rules on default bearer.
- ADC over Gx for HTTP Redirect is not qualified for Dedicated bearers.

Licensing

ADC over Gx feature requires Application Detection Control License. Contact your Cisco account representative for detailed information on specific licensing requirements.

Configuring ADC over Gx

The CLI commands available for ADC Over Gx in non-CUPS environment can be used in CUPS environment.

Following are the sample configurations to:

- Enable the feature under Policy Control Configuration mode:

```
diameter encode-supported-features adc-rules
```

- Configure ADC predefined rule under ACS Rulebase Configuration mode:

```
action priority 55 dynamic-only adc ruledef qci5 charging-action charge-action-qci5
action priority 56 dynamic-only adc mute group-of-ruledefs qci5_gor charging-action
charge-action-qci5
```



Important

Application START/STOP will not be sent to PCRF if the Application START/STOP event trigger is not registered while enabling the ADC Over Gx feature.



Important

For additional information about the CLI commands, refer the *Command Line Interface Reference*.

Monitoring and Troubleshooting

This section describes the CLI commands available to monitor and/or troubleshoot the feature.

Monitor Protocol

When using the monitor protocol command, enable option 49 to see ADC related parameters in Sx messages.

Show Command(s) and/or Outputs

On C-Plane

show active-charging subscribers callid <callid> urr-info

The output of this show command has been modified to display the ADC URRs along with Volume and Duration related URRs.

On U-Plane

show subscribers user-plane-only full all

The output of this show command has been modified to display the “Number of associated ADC PDRs”.

show subscribers user-plane-only callid <callid> pdr full all

The output of this show command has been modified to display the following new fields:

- TDF App Id
- TDF Notifications
- Total ADC PDRs found

show subscribers user-plane-only callid <callid> urr full all

The output of this show command has been modified to display the ADC URRs along with Volume and Duration related URRs.

show user-plane-service rulebase name <rulebase_name>

The output of this show command has been enhanced in support of this feature. Two new Type characters are introduced to identify ADC rules and ADC rules with “mute”:

- RDA – Where A is for ADC rule
- GDAM – Where AM is for ADC rule with “mute”

show sub user-plane-only full all

The output of this show command has been enhanced to display information about ADC PDRs and redirected flows:

- Flow Action Redirected Flows
- Number of associated ADC PDRs

show user-plane-service statistics all

The output of this show command has been enhanced to display the following new field under ADC Redirect Stats:

- ADC Redirected Flows



CHAPTER 6

Addition of IP Pool in IP Group

- [Revision History](#), on page 99
- [Feature Description](#), on page 99
- [How it Works](#), on page 100
- [Monitoring and Troubleshooting](#), on page 100

Revision History



Note Revision history details are not provided for features introduced before release 21.24.

Revision Details	Release
First introduced	Pre 21.24

Feature Description

In the existing CUPS platform, when a new IP pool is added, only the User Planes (UPs) that register after the creation of the new pool can use these pools. If any existing UP requires to use the new pool, a UP reload or UP reassociation is performed.

The Addition of IP Pool in IP Group feature ensures that when a new IP pool is added, each existing UP is evaluated based on whether its APN configuration makes it eligible to get chunks from this new pool. If the UP is eligible, then chunks are allocated to the UP and it is used for future call allocation.

The eligibility of the UP is determined in the following scenarios:

- APN has a pool-group configured. A new pool is added under this pool-group.
- APN has no pool-name or pool-group configured. A new public pool is added.



Note Any changes implemented on the APN do not take affect until the UP is reassociated or reloaded.

How it Works

This section briefly describes how the Addition of IP Pool in IP Group feature works.

Adding New Pools in a CP-CP ICSR Environment

1. Add the new pool in the Standby Control Plane (CP).
2. Add the new pool in the Active CP.

Chunks are allocated to the eligible UPs and the same are checkpointed to the Standby CP.

3. Verify whether **show { ip | ipv6 } pool-chunks pool-name <name>** command in both the CPs are synchronized.

Delete Pools in CP-CP ICSR Environment

1. Delete the pool in the Active CP.
2. Ensure that all the IPs are free from the deleted pool in the Standby CP, using the **show { ip | ipv6 } pools** command.
3. Delete the pool in the Standby CP.



Note Adding the IP Pool command and the Busyout command of the same IP Pool at the same time creates a race condition. To avoid the issues, run the IP Pool command and Busyout command separately.

Monitoring and Troubleshooting

This section provides information regarding the CLI command available in support of monitoring and troubleshooting the feature.

Show Command(s) and/or Outputs

This section provides information regarding show commands and/or their outputs in support of this feature.

show ip user-plane verbose

The output of this CLI command displays the following fields in support of the Addition of IP Pool in IP Group feature in CUPS mode:

- Dynamic pool count
- apn-without-pool-name-v4
- apn-without-pool-name-v6
- Pool-groups

- Pool-Group-Names

show ip user-plane verbose



CHAPTER 7

APN ACL Support

- [Revision History](#), on page 103
- [Feature Description](#), on page 103
- [Troubleshooting](#), on page 104

Revision History



Note Revision history details are not provided for features introduced before release 21.24.

Revision Details	Release
First introduced	Pre 21.24

Feature Description

Currently in CUPS (pre 21.19.x release), the APN level ACL definitions are configured on UP.

With this feature, ACLs configured on CP are pushed to UP. This feature saves the cost and effort of configuring separate ACL definitions on all UP nodes.

**Note**

- Verify the APN ACLs in CP configuration before proceeding with the upgrade to the release.
- The configuration must have the same context names in both CP and UP. CP can have more contexts than UP. If the context names do not match, the respective ACLs are dropped at UP.
- It is recommended to not define APN ACLs in both CP and UP. However, if there is a requirement, the ACL names in both UP and CP must be different from each other to avoid any conflicts.
- To ensure backward compatibility, ACLs locally created in UP configuration gets preference.
- If an APN belongs to a specific user-plane-group, ACLs for the same APN are pushed to only those UPs, which are part of the same user-plane-group.
- A maximum of 64 contexts is allowed and a maximum of 16 ACLs per context.
- Multiple APNs can share an ACL in the same context.
- Changes to an ACL are applicable only for new sessions, but not for ongoing sessions.
- If a **deny any** rule is configured in IPv6 ACLs, the Router advertisement (RA) and Router Solicitation (RS) messages must be explicitly allowed in ACL.

Troubleshooting

This section describes how to troubleshoot this feature.



Note This feature is enabled by default.

Show commands

This section describes the show commands for this feature.

show user-plane-service ip-access-list name *access list name*

This command is used to display ACL rules on user plane.

show user-plane-service pdn-instance name *apn name*

This command is used to display the access group for an apn on user plane.

show srp statistics

This command is used to display the sent, received, and discarded packet count for APN ACLs over SRP.

show demux-mgr statistics sxdemux all

This show command is used to display the number of PFD ACL_INFO packets sent from CP.



CHAPTER 8

APN AMBR Traffic Policing

- [Revision History](#), on page 105
- [Feature Description](#), on page 105
- [Configuring the APN AMBR Traffic Policing Feature](#), on page 106
- [Monitoring and Troubleshooting](#), on page 106

Revision History



Note Revision history details are not provided for features introduced before release 21.24.

Revision Details	Release
First introduced	Pre 21.24

Feature Description

The APN-AMBR is a subscription parameter stored per APN in the HSS. S-GW provides APN-AMBR during default bearer establishment procedure. APN-AMBR limits the aggregate bit rate that can be expected to be provided across all non-GBR bearers and across all PDN connections of the same APN. Each of those non-GBR bearers could potentially utilize the entire APN-AMBR, for example, when the other non-GBR bearers don't carry any traffic. The P-GW enforces the APN-AMBR in downlink and uplink direction.

As part of this CLI-controlled feature, the CLI parameters must be configured on Control Plane and propagated to User Plane through Sx interface.

Limitations

The following is the known limitation of APN-AMBR Traffic Policing feature:

- Configuring **token-replenishment-interval** and **violate-action shape** CLIs aren't supported.

Configuring the APN AMBR Traffic Policing Feature

This section describes how to configure the APN-AMBR Traffic Policing feature.

```
configure
  context context_name
  apn apn_name
  apn-ambr rate-limit direction { downlink | uplink } [ burst-size
{ auto-readjust duration { milliseconds msec | seconds } | violate-action
{ drop | lower-ip-precedence | transmit }
  end
```

NOTES:

- **rate-limit direction { downlink | uplink }**: Specifies that the rate limit is to be applied to either the downlink (network to subscriber) traffic or the uplink (subscriber to network) traffic.
- **burst-size { auto-readjust duration milliseconds msec | seconds }**: This parameter is used by policing algorithms to permit short bursts of traffic not to exceed the allowed data rates. It's the maximum size of the token bucket.
 - **auto-readjust duration seconds**: The duration (in seconds) used in this burst size calculation: burst size = peak data rate/8 * auto-readjust duration.
 - Seconds must be an integer value from 1-30. Default is 1 second.
 - **milliseconds**: msec must be an integer value from 100-900, in increments of 100 milliseconds. For example, 100, 200, or 300, and so on.
- **violate-action { drop | lower-ip-precedence | transmit }**: The action that the P-GW takes when the data rate of the bearer context exceeds the AMBR.
 - **drop**: Drops violating packets.
 - **lower-ip-precedence**: Sets the DSCP value to zero ("best effort") for violating packets.
 - **transmit**: Transmits violating packets. This is the default behavior of the feature.
- Prior to this feature, the default behavior was to drop the violating packets.

Monitoring and Troubleshooting

This section provides information about the commands available to monitor and/or troubleshoot the APN-AMBR Traffic Policing feature.

Show Commands and or Outputs

This section provides information about the show commands available for monitoring and/or troubleshooting the APN-AMBR Traffic Policing feature.

- **show user-plane-service pdn-instance name <apn_name>**: The following APN-AMBR information is available on User Plane after APN-AMBR CLI is configured on Control Plane and PFD Push to User Plane is completed:

- APN-AMBR
 - Downlink Apn Ambr: Indicates if the rate limit is enabled or disabled for downlink traffic.
 - Burst Size: Indicates the burst size of the downlink traffic.
 - Auto Readjust: Indicates if the auto-readjust is enabled or disabled for downlink burst size.
 - Auto Readjust Duration: Indicates the duration used in downlink burst size calculation.
 - Burst Size(bytes): Indicates the burst size in bytes.
 - Violate Action: Indicates the action that the P-GW takes when the data rate of the bearer context exceeds the AMBR for downlink traffic.
 - Uplink Apn Ambr: Indicates if the rate limit is enabled or disabled for uplink traffic.
 - Burst Size: Indicates the burst size of the uplink traffic.
 - Auto Readjust: Indicates if the auto-readjust is enabled or disabled for uplink burst size.
 - Auto Readjust Duration: Indicates the duration used in uplink burst size calculation.
 - Burst Size(bytes): Indicates the burst size in bytes.
 - Violate Action: Indicates the action that the P-GW takes when the data rate of the bearer context exceeds the AMBR for uplink traffic.
 - Token Replenishment Interval: Indicates the token replenishment interval duration.

- **show sub user-plane-only full all**:

Use this show command in User Plane to see the count of packets that are dropped, and IP precedence lowered due to APN-AMBR policer. The following fields are introduced in support of this feature:

- APN AMBR Uplink Pkts Drop: Indicates the number of APN-AMBR packets that are dropped for uplink traffic.
- APN AMBR Uplink Bytes Drop: Indicates the number of APN-AMBR bytes that are dropped for uplink traffic.
- APN AMBR Uplink Pkts IP pref lowered: Indicates the number of APN-AMBR uplink packets for which IP precedence is lowered.
- APN AMBR Uplink Bytes IP pref lowered: Indicates the number of APN-AMBR uplink bytes for which IP precedence is lowered.
- APN AMBR Downlink Pkts Drop: Indicates the number of APN-AMBR packets that are dropped for downlink traffic.
- APN AMBR Downlink Bytes Drop: Indicates the number of APN-AMBR bytes that are dropped for downlink traffic.

- APN AMBR Downlink Pkts IP pref lowered: Indicates the number of APN-AMBR downlink packets for which IP precedence is lowered.
- APN AMBR Downlink Bytes IP pref lowered: Indicates the number of APN-AMBR downlink bytes for which IP precedence is lowered.



CHAPTER 9

APN Data Tunnel MTU Size Configuration

- [Revision History, on page 109](#)
- [Feature Description, on page 109](#)
- [Configuring MTU, on page 110](#)

Revision History



Note Revision history details are not provided for features introduced before release 21.24.

Revision Details	Release
First introduced	Pre 21.24

Feature Description

The enhanced packet core (EPC) defines many different interfaces that require encapsulation of IPv4 and IPv6 data packets. Because the EPC adds encapsulating headers, additional care must be taken when fragmenting IPv4 and IPv6 packets.

Appropriate configuration should not result in fragmentation at any node in EPC. This feature fragments the IPv6 and IPv4 packets based on their MTU.

In RFC-4861 there is a provision to send the Maximum Transmission Unit (MTU) in Router Advertisement (RA) messages. P-GW supports the sending of the IPv6 MTU option in RAs for IPv6 and IPv4v6 PDN types towards the UE. The (Internet) can now send downlink data packet and based on the configured MTU, data fragmentation is performed at the source, if required. This feature also reduces the number of ICMPv6 Packet Too Big Error messages in the customer's network.

The MTU size is configurable through the Command Line Interface (CLI) on P-GW.

Limitation

- For P-GW/SAEGW IPv6 session, when packet exceeds the APN MTU value the CLI **policy ipv6 tunnel mtu exceed notify-sender** is not supported as ICMP is not available in VPP.
- For GGSN/P-GW/SAEGW IPv4 session, when packet (with df bit) exceeds the APN MTU value the CLI **access-link ip-fragmentation df-fragment-and-icmp-notify** is not supported as ICMP is not available in VPP.
- For GGSN/P-GW/SAEGW IPv4 session, when packet (with df bit) exceeds the APN MTU value the CLI **access-link ip-fragmentation normal** is not supported as ICMP is not available in VPP.

Configuring MTU

The following CLI commands configures the Maximum Transmission Unit (MTU) for data sent on the IPv4 and IPv6 tunnel between the P-GW and the mobile node:

```
configure
  context context_name
    apn apn_name
      ppp mtu bytes
      data-tunnel mtu bytes
      policy ipv6 tunnel mtu exceed { fragment inner | notify-sender |
fragment }
      access-link ip-fragmentation { df-ignore | normal |
df-fragment-and-icmp-notify }
    end
```

NOTES:

- **bytes**: Specifies the MTU for the IPv6 tunnel between the P-GW and the mobile node. bytes must be an integer between 1280 and 2000. Default: 1500.
- **ppp**: Specifies data sent on the IPv4 tunnel between P-GW and mobile node.
- **data-tunnel mtu**: Specifies data sent on the IPv6 tunnel between P-GW and mobile node.
- **fragment inner**: Performs one time fragment at GTP tunnel initiator.
- **notify-sender**: System will drop the incoming packet and send "ICMPv6 Packet Too Big" to the original sender.



Note This is also the default CLI configuration, hence this should be the default behavior when nothing is explicitly configured.

- **fragment**: Performs fragmentation or reassembly at intermediate GTP hops.
- **df-ignore**: Ignores the DF (Don't Fragment) bit setting; fragments and forwards the packet over the access link.



Note This is also the default CLI configuration, hence this should be the default behavior when nothing is explicitly configured.

- **df-fragment-and-icmp-notify**: Partially ignores the DF bit; fragments and forwards the packet, but also returns an ICMP error message to the source of the packet. The number of ICMP errors sent like this is rate-limited to one ICMP error packet per second per session.
- **normal**: Drops the packet and sends an ICMP unreachable message to the source of packet.



CHAPTER 10

Bearer Inactivity Timeout

- [Bearer Inactivity Timeout, on page 113](#)
- [Revision History, on page 113](#)
- [Feature Description, on page 113](#)

Bearer Inactivity Timeout

Revision History



Note Revision history details are not provided for features introduced before release 21.24.

Revision Details	Release
First introduced	Pre 21.24

Feature Description

Bearer inactivity timeout feature in CUPS enables the deletion of bearers that utilizes less data traffic than the configured threshold value, by monitoring the activity on the respective bearer. This allows for more efficient use of radio resources. The configuration of bearer inactivity timer and the threshold value of the traffic is done under APN configuration mode for P-GW, and APN Profile configuration mode for S-GW. The bearer inactivity timer can also be configured to exclude the default-bearer/primary-bearer from monitoring the bearer inactivity.

The Control Plane in CUPS supports the following bearer inactivity timer configuration options:

- `timeout bearer-inactivity [gbr | non-gbr] dur_seconds volume-threshold { downlink | total | uplink } bytes`
- `timeout bearer-inactivity exclude-default-bearer`

Based on the bearer inactivity configuration, a new bearer-level URR is created and associated with every PDR that is created for a bearer. When the timer expiry is detected, the User Plane monitors if the intended volume threshold is reached for the bearer, and sends a session usage report if bearer inactivity is detected. The Control Plane, after receiving the usage report, initiates the deletion of the respective bearer with disconnect reason set as "Bearer Inactivity Timeout".



CHAPTER 11

Bulk Statistics Support

- [Feature Description, on page 115](#)

Feature Description

Bulkstats is a collection of software features and framework in the existing legacy StarOS architecture that collects and exports the packet core node's important performance and health related statistics to an external node. These statistics provide an effective way for the operators to monitor the overall health and performance of the nodes and helps them take corrective actions or optimize the packet core network for better utilization thereby helping to reduce the overall opex costs of the operators. The individual statistics are configured to be collected in a group called 'schema'.

The system's support for bulk statistics allows operators to choose to view not only statistics that are of importance to them, but also to configure the format in which it is presented. This simplifies the post-processing of statistical data since it can be formatted to be parsed by external, back-end processors.

Statistics or bulk statistics reporting is an important aspect of a Mobile Packet Core node. In order for a product to be deployed in the network it has to support statistics that meets Carrier Grade requisites. Bulk statistics are used by Operators for the following:

- Performance KPI monitoring
- Network Fault analysis and debugging
- Network Optimization
- Traffic pattern analysis
- Node health analysis

When used along with an element management system (EMS), the data can be parsed, archived, and graphed.

In the CUPS environment, the system can be configured to collect Control Plane (CP) and User Plane (UP) bulk statistics and send them to a collection server (called a receiver).

The system supports the configuration of up to four sets (primary/secondary) of receivers. Each set can be configured to collect specific sets of statistics from the supported list of schemas. Statistics can be pulled manually from the system or sent at configured intervals. The bulk statistics are stored on the receiver(s) in files.

The format of the bulk statistic data files can be configured by the user. Users can specify the format of the filename, file headers, and/or footers to include information such as the date, system hostname, system uptime,

the IP address of the system generating the statistics (available for only for headers and footers), and/or the time that the file was generated.

An EMS is capable of further processing the statistics data through XML parsing, archiving, and graphing.

The Bulk Statistics Server component of an EMS parses collected statistics and stores the information in its PostgreSQL database. It can also generate XML output and can send it to a Northbound NMS or an alternate bulk statistics server for further processing.

Additionally, the Bulk Statistics server can archive files to an alternate directory on the server. The directory can be on a local file system or on an NFS-mounted file system on an EMS server.



Note Due to high dependency on the web element manager (WEM), it is observed that using file-1 as the default receiver with redundant and secondary-on-failure option results in issues. To solve this issue Cisco recommends using other files such as file-2, file-3 and file-4.

Bulk statistics in CUPS is implemented as follows:

- The CP and UP collects and exports the statistics separately to an aggregator node in the CUPS architecture.
- The receiver co-relates the statistics from CP and UP using the node-names or any other information configured as part of bulk stats configuration. Any EMS tool can render this data similar to how it is rendered from a standalone system.
- Bulk statistics schemas are categorized into the following:
 - **Control Plane:** These schemas must be configured only in the Control Plane node.
 - **User Plane:** These schemas must be configured only in the User Plane node.
 - **Shared:** In this type of schema, some counters are applicable only on CP and some are on UP. When the schemas are configured on both nodes, only relevant counters will be retrieved.
 - **Both:** These schemas are applicable to both Control Plane and User Plane nodes.



Caution Schemas have to be configured only on their respective nodes. Configuration of non-relevant schemas can result in performance impact, undesired behavior, and so on. For example, If a CP schema is configured on a UP schema the statistics would never be collected leading to performance impact.

- The current bulk statistics proctlet is implemented as defined in the existing StarOS system.
- The configuration changes remain as defined in the existing StarOS system.

In this release, the following list of schemas are supported in the CUPS architecture:

- APN
- APN-Expansion
- APN-QCI-Duration
- CARD

- Context
- DCCA
- DCCA-Group
- Diameter
- DPCA
- ECS
- EGTPC
- GTPP
- GTPU
- ICSR
- IMSA
- IP-Pool
- P2P
- P-GW
- P-GW-EGTPC-S2A
- P-GW-EGTPC-S2B
- P-GW-EGTPC-S5S8
- PORT
- RADIUS
- RADIUS-Group
- Rulebase
- SAE-GW
- S-GW
- System
- VLAN-NPU
- Sx

APN Schema

Currently there are no APNs defined on the UP. Therefore, there are no APN level counters available. However, the PDN instance is used, which is mapped with the bulk statistics counters and is retrieved accordingly.

SAE-GW/S-GW/P-GW Schema

Packet and Byte counters on the UP are available on the UP for only for a single service - userplane service. The PDR information available when the statistics counters are pushed from VPP is used for services such as - P-GW, S-GW and SAE-GW, on different UP interfaces such as S1-U, S4/S8 and so on. The sessmgr

maps the PDR information to a bearer or CLP to increment the respective counter. Various counters are added and implemented for each of the P-GW, S-GW and SAE-GW services.

Mapping QCI values to these counters is supported. The QCI+ARP value is sent in the TEID field of the SX packet from the CP to UP that is in turn pushed to the CLP. The CLP contains a TID value. When the statistics are incremented on UP, the QCI counters are mapped with the respective TID values received from VPP, and the QCI statistics are incremented accordingly.

SX Schema

The SX schema is a new schema added in support of bulk statistics for CUPS. Around 160 statistics counter exist for an SX service that are applicable to both CP and UP. The same schema can be configured on both CP and UP. The counters in this schema provide statistics about SX service usage between CP and UP. This schema is not applicable in the non-CUPS architecture.



Important For more information on bulk statistic configuration, refer to the *Bulk Statistics* chapter in the *ASR 5500 System Administration Guide*.



CHAPTER 12

Cisco Ultra Traffic Optimization with VPP

- [Revision History](#), on page 119
- [Feature Description](#), on page 119
- [RCM Support](#), on page 120
- [Sending the GBR or MBR Values to Cisco Ultra Traffic Optimization](#), on page 120
- [How it Works](#), on page 121
- [Show Commands and Outputs](#), on page 122
- [Sample Configuration](#), on page 128

Revision History



Note Revision history details are not provided for features introduced before release 21.24.

Revision Details	Release
First introduced	Pre 21.24

Feature Description

Cisco Ultra Traffic Optimization is supported on VPP in the CUPS architecture.

The Cisco Ultra Traffic Optimization is a RAN optimization technology that increases subscriber connection speeds in congested cells and, as a result, increases the cell capacity significantly. The result is an optimized RAN, where Mobile Network Operators (MNOs) can deploy fewer cells, on an ongoing basis, and absorb more traffic growth while meeting network quality targets.

Large traffic flows, such as Adaptive Bit Rate (ABR) video, saturate radio resources and swamp the eNodeB scheduler. The Cisco Ultra Traffic Optimization employs machine learning algorithms to detect large traffic flows (such as video) in the network and optimize the delivery of those flows to mitigate the network congestion without changing user quality (that is, video works the same for the end user). In other words, by employing software intelligence at the network core, Cisco Ultra Traffic Optimization mitigates the overwhelming impact video has on the RAN.

The resulting benefits are seen in congested network sites. The Cisco Ultra Traffic Optimization:

- Increases average user throughput.
- Increases congested cell site capacity.
- Reduces scheduler latency.
- Maintains user quality of experience even when more users and more traffic share a cell.
- Is measured directly by eNodeB performance counters (for example, average UE throughput, scheduler latency), which are the key performance indicators that are used for network capacity planning.
- Provides permanent savings in RAN investment requirements.
- Is integrated in the Cisco StarOS P-GW.
- Requires no new hardware or cabling complexity - it can be turned on for a market in an hour.
- Supports HTTP(s) and QUIC traffic.

Licensing

The Cisco Ultra Traffic Optimization with VPP is a licensed Cisco solution. Contact your Cisco account representative for detailed information on specific licensing requirements. For information on installing and verifying licenses, refer to the *Managing License Keys* section of the *Software Management Operations* chapter in the *System Administration Guide*.

RCM Support

This feature enables the Redundancy and Configuration Management (RCM) support for the Cisco Ultra Traffic Optimization (CUTO). All relevant configuration to enable the Cisco Ultra Traffic Optimization (CUTO) using service scheme and application of the Cisco Ultra Traffic Optimization (CUTO) profile or policy on User Plane is supported using RCM.

Sending the GBR or MBR Values to Cisco Ultra Traffic Optimization

During the stream create/update, a bearer with valid QER and is GBR bearer, the respective bearer level downlink GBR/MBR values are sent to Cisco Ultra Traffic Optimization (CUTO) library as lower or upper limit values otherwise lower limit or upper limit values are zero. The values of lower limit and upper limit are in Bits Per Second (BPS). Post RCM support, the P-GW sends the downlink flow level GBR and MBR values instead of bearer level GBR and MBR to the optimization library. For GBR bearer, flow level GBR is sent as lower limit and flow level MBR is sent as the upper limit to the Cisco Ultra Traffic Optimization (CUTO) library. For non-GBR bearer 0 is sent as lower limit and flow level MBR is sent as upper limit to the Cisco Ultra Traffic Optimization (CUTO) library. If the flow level MBR is greater than the APN-AMBR for a non GBR bearer, traffic is throttled at APN-AMBR. In such a case APN-AMBR is sent as the upper limit to the Cisco Ultra Traffic Optimization (CUTO) library. If there is no valid flow level MBR specific to the flow, APN-AMBR is sent as the upper limit to the Cisco Ultra Traffic Optimization (CUTO) library. Optimization library maintains logical flow based on 3-tuple (That is source IP, destination IP and protocol), whereas the non-CUPS architecture considers a flow as 5-tuple (That is source IP, destination IP, source port, destination port and protocol). Hence multiple non-CUPS architecture 5-tuple entries can belong to same

3-tuple entry in optimization library. The PG-W provides GBR and MBR values based on 5-tuple to the optimization library. As part of this feature:

- Optimization library uses the minimum of all MBR values that belong to same 3-tuple entry as upper limit.
- Optimization library uses maximum of all GBR values that belong to same 3-tuple entry as lower limit.

Cisco Ultra Traffic Optimization Library Deinitialization

This feature currently doesn't support the Deinitialization. Deinitialization happens when the Cisco Ultra Traffic Optimization (CUTO) license is removed from the system.

How it Works

Architecture

The following figure illustrates the architecture of Cisco Ultra Traffic Optimization on VPP in CUPS.

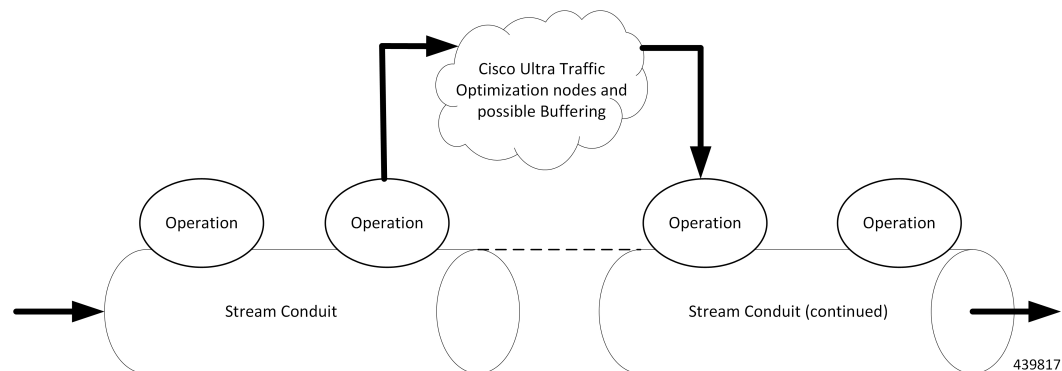

Cisco Ultra Traffic Optimization is split across Control Plane and User Plane.

CUTO-CTRL

- CUTO-CTRL receives guidance and requests from SMGR through the East-West API (EWAPI), through which clients (SMGR instances) are registered and de-registered, and new streams/flows are created and terminated.
- CUTO-CTRL manages a set of shared memory (SHM) tables using a North-South API (NSAPI) consisting of Cisco-provided SHM infrastructure.
- It is through this SHM environment that CUTO-VPP can read and write content that is visible to both CUTO-VPP and CUTO-CTRL.
- The SHM is used for all high volume, scalable/mutable content necessary for the high-performance configuration and administration of the CUTO solution in VPP.

CUTO-VPP

- CUTO-VPP is the packet processing engine in the user plane.
- In fastpath, Cisco Ultra Traffic Optimization is applied to packets on a stream configured with its operation.
- Packets are sent from the Stream conduit to a particular CUTO-VPP operation, and after some potential delay (0-N milliseconds), traffic is returned to the same Conduit.
- Packets are never dropped by the Cisco Ultra Traffic optimization application.

Limitations

The Cisco Ultra Traffic Optimization feature in CUPS has the following limitations:

- CUTO configuration changes done in Service Schema do not take effect immediately for existing flows.
- Cisco Ultra Traffic Optimization VPP global deinitialization is not supported.
- Dynamic memory allocation between SMGR and CUTO-VPP.
- Bearer-related triggers for enabling Cisco Ultra Traffic Optimization are not supported.
- Rule match change trigger must be configured for CUTO in CUPS.
- Disabling of Traffic optimization is not supported on 'loc-update' trigger.
- Enabling Cisco Ultra Traffic Optimization via Gx is not supported.
- Removal of CUTO license will not trigger global deinitialization. CUTO configurations must be removed to disengage CUTO functionality for new flows.

Show Commands and Outputs

This section provides information regarding show commands and their outputs in support of Cisco Ultra Traffic Optimization in CUPS.

For information on other supporting show commands, refer to *Monitoring and Troubleshooting* section under the *Cisco Ultra Traffic Optimization* chapter in the *P-GW Administration Guide*.

Show Commands and Outputs

show user-plane-service traffic-optimization counters sessmgr all

The output of this command includes the following fields:

TCP Traffic Optimization Flows:

- Active Normal Flow Count
- Active Large Flow Count
- Active Managed Large Flow Count
- Active Unmanaged Large Flow Count

- Total Normal Flow Count
- Total Large Flow Count
- Total Managed Large Flow Count
- Total Unmanaged Large Flow Count
- Total IO Bytes
- Total Large Flow Bytes
- Total Recovered Capacity Bytes
- Total Recovered Capacity ms

UDP Traffic Optimization Flows:

- Active Normal Flow Count
- Active Large Flow Count
- Active Managed Large Flow Count
- Active Unmanaged Large Flow Count
- Total Normal Flow Count
- Total Large Flow Count
- Total Managed Large Flow Count
- Total Unmanaged Large Flow Count
- Total IO Bytes
- Total Large Flow Bytes
- Total Recovered Capacity Bytes
- Total Recovered Capacity ms

show user-plane-service traffic-optimization info

The output of this command includes the following fields:

- CUTO Ctrl Library Version
- CUTO VPP Library Version
- Mode
- Configuration

show user-plane-service traffic-optimization policy all

The output of this command includes the following fields:

- Policy Name
- Policy-Id

- Bandwidth-Mgmt
 - Backoff-Profile
 - Min-Effective-Rate
 - Min-Flow-Control-Rate
- Curbing-Control:
 - Time
 - Rate
 - Max-Phases
 - Threshold-Rate
- Heavy-Session:
 - Threshold
 - Standard-Flow-Timeout
- Link-Profile:
 - Initial-Rate
 - Max-Rate
 - Peak-Lock
- Session-Params:
 - Tcp-Ramp-Up
 - Udp-Ramp-Up

Bulkstats

The following existing bulk statistics are supported by Cisco Ultra Traffic Optimization in CUPS:

Bulk Statistics	Description
cuto-uplink-drop	Indicates the total number of uplink packets dropped by CUTO library
cuto-uplink-hold	Indicates the total number of uplink packets held by CUTO library
cuto-uplink-forward	Indicates the total number of uplink packets forwarded by CUTO library
cuto-uplink-rx	Indicates the total number of uplink packets received by CUTO library
cuto-uplink-tx	Indicates the total number of uplink packets sent by CUTO library

Bulk Statistics	Description
cuto-dnlink-drop	Indicates the total number of downlink packets dropped by CUTO library
cuto-dnlink-hold	Indicates the total number of downlink packets held by CUTO library
cuto-dnlink-forward	Indicates the total number of downlink packets forwarded by CUTO library
cuto-dnlink-rx	Indicates the total number of downlink packets received by CUTO library
cuto-dnlink-tx	Indicates the total number of downlink packets sent by CUTO library
cuto-todrs-generated	Indicates the total number of TODRs generated.
tcp-active-normal-flow-count	Indicates the number of TCP active-normal-flow count for Cisco Ultra Traffic Optimization.
tcp-active-large-flow-count	Indicates the number of TCP active-large-flow count for Cisco Ultra Traffic Optimization.
tcp-active-managed-large-flow-count	Indicates the number of TCP active-managed-large-flow count for Cisco Ultra Traffic Optimization.
tcp-active-unmanaged-large-flow-count	Indicates the number of TCP active-unmanaged-large-flow count for Cisco Ultra Traffic Optimization.
tcp-total-normal-flow-count	Indicates the number of TCP total-normal-flow count for Cisco Ultra Traffic Optimization.
tcp-total-large-flow-count	Indicates the number of TCP total-large-flow count for Cisco Ultra Traffic Optimization.
tcp-total-managed-large-flow-count	Indicates the number of TCP total-managed-large-flow count for Cisco Ultra Traffic Optimization.
tcp-total-unmanaged-large-flow-count	Indicates the number of TCP total-unmanaged-large-flow count for Cisco Ultra Traffic Optimization.
tcp-total-io-bytes	Indicates the number of TCP total-IO bytes for Cisco Ultra Traffic Optimization.
tcp-total-large-flow-bytes	Indicates the number of TCP total-large-flow bytes for Cisco Ultra Traffic Optimization.
tcp-total-recovered-capacity-bytes	Indicates the number of TCP total-recovered capacity bytes for Cisco Ultra Traffic Optimization.
tcp-total-recovered-capacity-ms	Indicates the number of TCP total-recovered capacity ms for Cisco Ultra Traffic Optimization.

Bulk Statistics	Description
udp-active-normal-flow-count	Indicates the number of UDP active-normal-flow count for Cisco Ultra Traffic Optimization.
udp-active-large-flow-count	Indicates the number of UDP active-large-flow count for Cisco Ultra Traffic Optimization.
udp-active-managed-large-flow-count	Indicates the number of UDP active-managed-large-flow count for Cisco Ultra Traffic Optimization.
udp-active-unmanaged-large-flow-count	Indicates the number of UDP active-unmanaged-large-flow count for Cisco Ultra Traffic Optimization.
udp-total-normal-flow-count	Indicates the number of UDP total-normal-flow count for Cisco Ultra Traffic Optimization.
udp-total-large-flow-count	Indicates the number of UDP total-large-flow count for Cisco Ultra Traffic Optimization.
udp-total-managed-large-flow-count	Indicates the number of UDP total-managed-large-flow count for Cisco Ultra Traffic Optimization.
udp-total-unmanaged-large-flow-count	Indicates the number of UDP total-unmanaged-large-flow count for Cisco Ultra Traffic Optimization.
udp-total-io-bytes	Indicates the number of UDP total-IO bytes for Cisco Ultra Traffic Optimization.
udp-total-large-flow-bytes	Indicates the number of UDP total-large-flow bytes for Cisco Ultra Traffic Optimization.
udp-total-recovered-capacity-bytes	Indicates the number of UDP total-recovered capacity bytes for Cisco Ultra Traffic Optimization.
udp-total-recovered-capacity-ms	Indicates the number of UDP total-recovered capacity ms for Cisco Ultra Traffic Optimization.

The following statistics for Cisco Ultra Traffic Optimization, that are part of the legacy (StarOS) implementation, are not applicable to the CUPS implementation.

- tcp-uplink-drop
- tcp-uplink-hold
- tcp-uplink-forward
- tcp-uplink-forward-and-hold
- tcp-uplink-hold-failed
- tcp-uplink-bw-limit-flow-sent
- tcp-dnlink-drop
- tcp-dnlink-hold

- tcp-dnlink-forward
- tcp-dnlink-forward-and-hold
- tcp-dnlink-hold-failed
- tcp-dnlink-bw-limit-flow-sent
- tcp-dnlink-async-drop
- tcp-dnlink-async-hold
- tcp-dnlink-async-forward
- tcp-dnlink-async-forward-and-hold
- tcp-dnlink-async-hold-failed
- tcp-process-packet-drop
- tcp-process-packet-hold
- tcp-process-packet-forward
- tcp-process-packet-forward-failed
- tcp-process-packet-forward-and-hold
- tcp-process-packet-forward-and-hold-failed
- tcp-pkt-copy
- tcp-pkt-Copy-failed
- tcp-process-pkt-copy
- tcp-process-pkt-copy-failed
- tcp-process-pkt-no-packet-found-action-forward
- tcp-process-pkt-no-packet-found-forward-and-hold
- tcp-process-pkt-no-packet-found-action-drop
- tcp-todrs-generated
- udp-uplink-drop
- udp-uplink-hold
- udp-uplink-forward
- udp-uplink-forward-and-hold
- udp-uplink-hold-failed
- udp-uplink-bw-limit-flow-sent
- udp-dnlink-drop
- udp-dnlink-hold
- udp-dnlink-forward

- udp-dnlink-forward-and-hold
- udp-dnlink-hold-failed
- udp-dnlink-bw-limit-flow-sent
- udp-dnlink-async-drop
- udp-dnlink-async-hold
- udp-dnlink-async-forward
- udp-dnlink-async-forward-and-hold
- udp-dnlink-async-hold-failed
- udp-process-packet-drop
- udp-process-packet-hold
- udp-process-packet-forward
- udp-process-packet-forward-failed
- udp-process-packet-forward-and-hold
- udp-process-packet-forward-and-hold-failed
- udp-pkt-copy
- udp-pkt-Copy-failed
- udp-process-pkt-copy
- udp-process-pkt-copy-failed
- udp-process-pkt-no-packet-found-action-forward
- udp-process-pkt-no-packet-found-forward-and-hold
- udp-process-pkt-no-packet-found-action-drop
- udp-todrs-generated

Sample Configuration

Sample configuration to enable CUPS CUTO feature:

```
configure
  active-charging service ACS
    trigger-action TA1
      traffic-optimization policy custom1
    #exit
  trigger-condition TC1
    rule-name = dynamic-rule2
  #exit
  service-scheme SS1
    trigger rule-match-change
      priority 5 trigger-condition TC1 trigger-action TA1
    #exit
```

```
subs-class SB1
  rulebase = cisco
#exit
subscriber-base default
  priority 5 subs-class SB1 bind service-scheme SS1
#exit
traffic-optimization-profile
  mode active
  data-record
#exit
traffic-optimization-policy custom1
  bandwidth-mgmt min-effective-rate 300 min-flow-control-rate 150
  heavy-session threshold 20000
  link-profile max-rate 20000
#exit
traffic-optimization-policy default
#exit
end
```



CHAPTER 13

Change Notification Support for Pure S

This chapter contains the following topics:

- [Revision History](#), on page 131
- [Feature Description](#), on page 131
- [How It Works](#), on page 131

Revision History



Note Revision history details are not provided for features introduced before release 21.24.

Revision Details	Release
First introduced	Pre 21.24

Feature Description

Cisco CUPS supports the Change Notification in Pure-S CUPS. If ULI/UCI changes are valid in CNReq, it generates the SGW CDR for ULI change. To support SGWCDR, SGW-C needs to fetch the latest data usage from U-Plane. After receiving the latest usage report, it triggers the CDR generation request. The Change Notification may contain Secondary RAT usage IE, in that case, if SGW generate SGWCDR, it contains the Secondary RAT usage.

How It Works

Call Flow

The following call flow shows the Change Notification support for Pure-S:

Figure 1: Change Notification Request

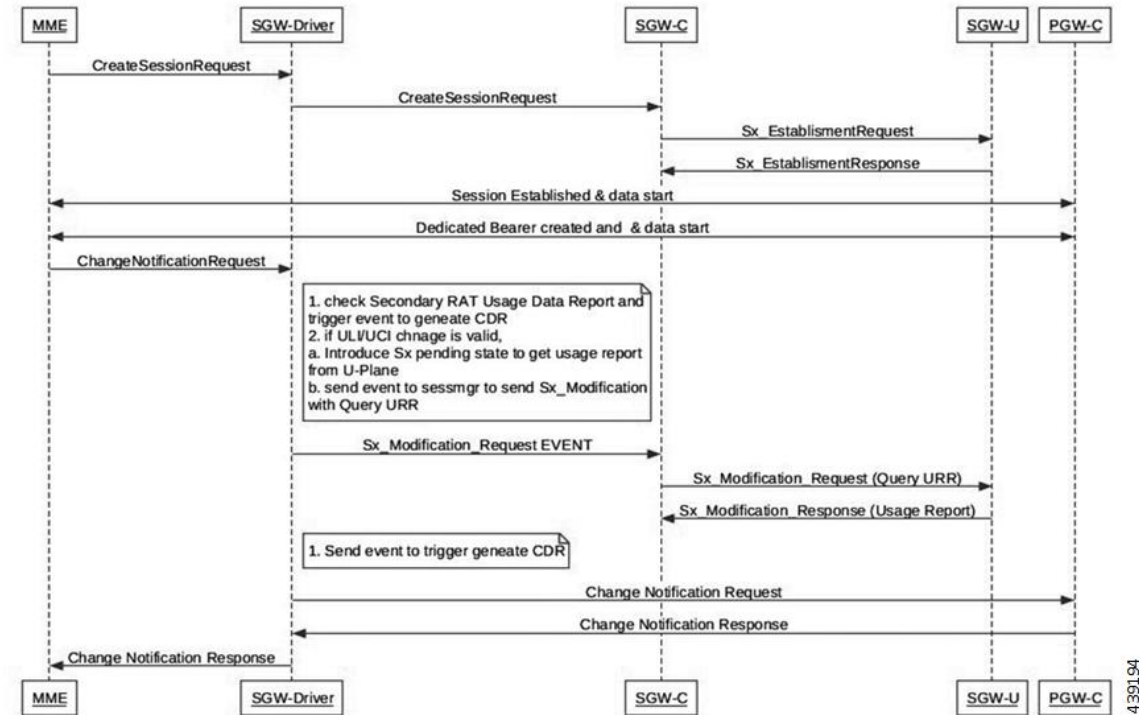

On receiving the Change Notification Request:

- If Secondary RAT Usage Data Report is present, it is included in CDR
- If ULI/UCI change is valid:
 - Added support to send the Event to SMGR to trigger Sx_Session_Modification request with Query URR to fetch latest data usage from U-Plane.
 - Added the pending state to get latest data usage to trigger ULI/UCI change CDR.
 - Send event to trigger generate CDR.



CHAPTER 14

Charging Action Configuration Change Support for Existing Sessions Gy and Gz Interface

- [Revision History, on page 133](#)
- [Feature Description, on page 133](#)
- [How It Works, on page 134](#)

Revision History



Note Revision history details are not provided for features introduced before release 21.24.

Revision Details	Release
First introduced	Pre 21.24

Feature Description

Configuration gap leads to improper usage report being sent to Gy and Gz in CDR, and delay in checkpointing also results in data loss due to the SR/ICSR process.

To overcome the gaps in the existing Pure-P and collapsed calls for Gy/Gz charging, the following configuration changes are implemented:

- “Rated to Free” and “Free to Rated” mid-call in the charging-action.
- Addition of high priority rule mid-call with different charging-action that has different Rating Group.
- Charging-action mid-call for the ruledef.

How It Works

Support for the following is added in the existing calls for configuration change related to charging-action and addition of high priority rule within the Rulebase.

Configuration Change Under Charging Action from Rated to Free and Free to Rated Mid Call

For the configuration change under the charging-action from “free to rated”, the Control Plane (CP) applies the change and creates the required URR for the Gy/Gz components. And, when the User Plane reports the usage report, the same report goes to the Gy interface and in the CDR based on the new changes.

When configuration change under charging-action is done from “rated to free”, The User Plane (UP) sends the data usage only for the rated configuration in the usage report to CP. After receiving the usage report, the same is reported to the Gy/Gz interface as applicable.

Configuration Change for Addition of High Priority Rule with Different Charging Action with Different Rating Group

Once you apply the configuration changes in the rulebase by adding a high priority rule with different charging-action and with different rating group. The User Plane sends the separate URR for new charging-action rule and the CP compares the URR with the configuration and handles the new URR. The CP sends the corresponding information to the Gy/Gz interface as applicable.

Configuration Change for Charging-Action Mid Call for the Ruledef

When configuration change is done in the Rulebase by changing the charging-action with different charging-action and with a different rating group. The CP handles the new URR received and sends the proper LOSDV in the CDR with correct Rating Group. Also, when the User Plane sends the start of the traffic after configuration change to the CP, the CP sends the Gy to the CCR-U to request for the quota.

URR Bucket Checkpointing Enhancement for Gy

Whenever the “sx-session-usage-report” comes from User Plane to Control Plane, the checkpointing does not happen immediately. It is done as part of full checkpoint. In between, if there is session recovery, the intermediate details are missed out. To avoid this issue, the micro checkpointing is needed as and when the “sx-session-usage-report” reaches to the Control Plane.

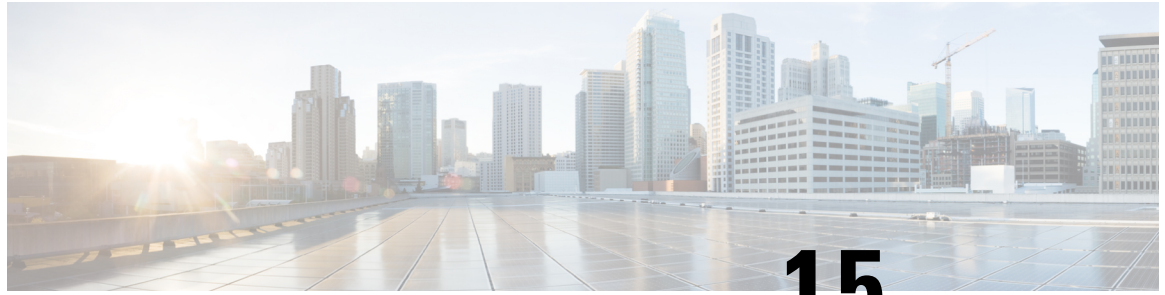

CHAPTER 15

CP Call Summary Log

- [Revision History](#), on page 135
- [Feature Description](#), on page 135
- [How it Works](#), on page 136
- [Configuring Call Summary Log in CP](#), on page 143
- [Monitoring and Troubleshooting](#), on page 144

Revision History



Note Revision history details are not provided for features introduced before release 21.24.

Revision Details	Release
With this release, new Sx-specific information are added in S-GW and P-GW event records.	21.24.1
First introduced	Pre 21.24

Feature Description

Call Summary Log is a mechanism using which subscriber activities like Session Creation/Deletion, Bearer Creation/Update/Deletion is reported to an external server.

When the Call Summary Log feature is enabled on the CUPS Control Plane (CP) node—where S-GW and/or P-GW records are generated depending upon SAEGW call type—generates events records and stores the records in chassis hard disk in CSV file format. The files are stored in .gz compressed format as well. These files are later SFTPed to external server for further analysis from network operator to maintain and troubleshoot the network.

This chapter captures the Call Summary Log feature for CUPS CP node. For information about Call Summary Log feature from CUPS User Plane (UP) node, see the *UPC CUPS User Plane Administration Guide*.

How it Works

S-GW Event Record

S-GW event reporting is a feature using which subscriber events like Session creation (PDN connect), Session deletion (PDN disconnect), Bearer Creation, Bearer Deletion, Bearer Modification and Bearer Update is reported to external SFTP server.

The interface between the S-GW and SFTP server is based on SFTP. Each record is generated as comma-separated ASCII values (CSV record). S-GW sends one ASCII formatted CSV record per line. The CSV records are stored in file and are compressed before sending to external SFTP server. The CSV records cannot be older than 15 minutes; therefore, the file needs to be SFTed to external SFTP server at least once in 15 minutes. The transfer of CSV record file between S-GW and SFTP server is based on either PULL or PUSH model. In PULL model, the external SFTP server is responsible for SFTP with S-GW. For PUSH model, S-GW is responsible for sending the CSV record file to external SFTP server based on the configured PUSH timer interval.

The following events trigger a record.

Event	Description
1	Session Creation
2	Session Deletion
3	Bearer Creation
4	Bearer Deletion
5	Bearer Modification (Suppress intra system handover)
6	Bearer Update

The report includes the following information in the CSV format:

No.	Description	Format Example
1	Event Identity	Integer [1-6]
2	Event Result (3GPP 29.274 Result Cause Code)	Integer [1-255]
3	IMSI	Integer (15 digits)
4	IMEISV	Intrger (16 digits)
5	Call-ID	Internal CallID. Example: [376efb10]
6	Start Time (GMT)	Time MM/DD/YYYY-HH:MM:SS
7	End Time (GMT)	Time MM/DD/YYYY-HH:MM:SS

No.	Description	Format Example
8	Protocol (GTPv2)	String GTPv2
9	Disconnect Reason	Integer [1-999]
10	Trigger Event (3GPP 29.274 request cause code)	Integer [1-6]
11	CP Name (Hostname)	String cisco.mnc311.mcc480.3gppnetwork.org
12	Origination Node Type	String (SGW HSGW PGW ...) SGW
13	EPS Bearer ID (Default)	Integer [1-15]
14	APN Name	String cisco.mnc311.mcc480.3gppnetwork.org
15	PGW IP Address	IPv4 or IPv6 Address
16	UE IPv4 Address	IPv4 Address
17	UE IPv6 Address	IPv6 Address
18	Uplink AMBR	Integer (0-4 Billion)
19	Downlink AMBR	Integer (0-4 Billion)
20	TAI-MCC/MNC/TAC	String(MCC;MNC;TAC) 311;480;0x5802
21	Cell ID (ECI)	String (8bytes) 0x158B33
22	EPS Bearer ID (Dedicated)	Integer (1-15)
23	Result Code (Success/Fail)	0=fail 1=success
24	QCI	Integer [1-255]
25	Uplink MBR	Integer (0-4 Billion)
26	Downlink MBR	Integer (0-4 Billion)
27	Uplink GBR	Integer (0-4 Billion)
28	Downlink GBR	Integer (0-4 Billion)
29	Downlink Packets Sent	Integer (0-4 Billion)
30	Downlink Bytes Sent	Integer (0-4 Billion)
31	Downlink Packets Dropped	Integer (0-4 Billion)

No.	Description	Format Example
32	Uplink Packets Sent	Integer (0-4 Billion)
33	Uplink Bytes Sent	Integer (0-4 Billion)
34	Uplink Packets Dropped	Integer (0-4 Billion)
35	MME S11 IP Address	IPv4 or IPv6 Address
36	S1u IP Address	IPv4 or IPv6 Address
37	User Plane IP Address	Contains User Plane IPv4 or IPv6 Address
38	Sx-PFCP Local SEID	Contains the SEID for CP node
39	Sx-PFCP Remote SEID	Contains the SEID for UP node
40	Sx-PFCP Cause Code	Contains the PFCP cause code
41	Sx-PFCP Response Time	Contains the PFCP transaction response time

P-GW Event Record

The P-GW generates the per call, per event call summary records with error or cause codes and latency information.

Currently, the feature supports the P-GW event records for the following six independent GTPv2 procedures.

Procedure Number	Procedure Name
1	GTP Create Session
2	GTP Create Bearer
3	GTP Delete Session
4	GTP Delete Bearer
5	GTP Modify Bearer
6	GTP Update Bearer
8...16	Diameter Procedures

The report includes the following information in the CSV format:

IE	Description	Definition or Format Example	Applicable Procedures (from Table above)
1	PGW RTT Record Number	<proclat-type> <instance-id> <RTT-record-#>	All
2	PGW RTT Version Number	Version 1 in v18.0	All
3	Procedure Number	Defined Table 1 (1 through 18)	All
4	PGW Name	Host Name of the Chassis	All

IE	Description	Definition or Format Example	Applicable Procedures (from Table above)
5	Procedure Start Time (GMT)	Time in UTC, (to ms accuracy)	All
6	Procedure End Time (GMT)	Time in UTC (to ms accuracy)	All
7	ASR5K CallID	Internal CallID. Example: [376efb10]	All
8...10	Reserved		
11	IMSI	Example: [311480076488840]	1
12	MSISDN	Example: [19728256305]	1, 5
13	IMEISV	Example: [9900028823793406]	1, 11, 15
14	TAI - MCC/MNC/TAC	Example: String [311-480-0x3B00]	1 through 6
15	Cell ID	ECI. Example: [0xE70D01]	1 through 6
16	ASR5K Disconnect Reason	Internal reason for session disconnect (e.g. timeout, error). Example: [0 to 533]	All (pending error)
17...20	Reserved		
21	Serving Network	MCC MNC. Example: [311480]	1, 5
22	Radio Access Technology	Defined in TS29.274. Example: [6 = E-UTRAN]	1, 5
23	Handover Indicator	HI field in Indication attribute; e.g. [0 = New PDN; 1 = Handover]	1, 5
24	SGW/HSGW TEID	Tunnel Identifier for Peer. Example: [0x26B609F0]	1, 2, 5
25	PGW TEID	Tunnel Identifier for PGW. Example: 0x084BC005	1, 2
26	AN GW Address	IP Address of Remote GW: HSGW or SGW	1, 2, 5
27	Access Point Name	String. Example: [vzwims.mnc311.mcc480.3gppnetwork.org]	1
28	Framed-IP Address	UE assigned IPv4 address	1
29	Framed-IPv6 Address	UE assigned IPv6 prefix/address	1
30	Uplink AMBR	In Kbps. Example: [0-4294967295]	1, 6
31	Downlink AMBR	In Kbps. Example: [0-4294967295]	1, 6
32	PCO DNS IPv6 Address – Primary	IPv6 Address	1
33	PCO DNS IPv6 Address - Secondary	IPv6 Address	1

IE	Description	Definition or Format Example	Applicable Procedures (from Table above)
34	PCO DNS IPv4 Address – Primary	IPv4 Address	1
35	PCO DNS IPv4 Address - Secondary	IPv4 Address	1
36	List of EPS Bearer IDs (Successful)	Each bearer Id shall be separated by a “ ” Example: 1 3 5	1, 2, 4, 5, 6
37	Linked Bearer Identity	Example: [0-15]	2, 3, 4, 5
38	Uplink MBR	In Kbps. MBR. For example, 1234 3456 567 MBR of each bearer shall be separated by “ ” and has same order as of IE 37 followed by 44	1, 6
39	Downlink MBR	Same as IE 38	1, 6
40	Uplink GBR	Same as IE 40	1, 6
41	Downlink GBR	Same as IE 41	1, 6
42	GTP Cause Value	Request/Acceptance/Rejection Cause, e.g. [1-255]	1 through 6
43	Piggyback Record Indicator	Explicit indication of piggyback message record, e.g. (0=no; 1=yes)	2, 5
44...50	Reserved		
51	Diameter IEs Session ID	Session-ID for Authentication Session, example, UTF8 String [0006-diamprox.y.WSBOMAGJPNC. S6b.vzims.com; 21604107; 449305093; 536f9359-503]	7 to 18, 24
52	Auth-Application ID	Example [S6b = 16777999 , Gx = 16777238, Gy = 4]	7 to 18, 24
53	PGW-Host (Origin Host)	FQDN of PGW, example [0004-diamprox.y.WSBOMAGJPNC. Gy.vzims. com]	7 to 18, 24
54	Diameter Peer Address Realm	FQDN of 3GPP AAA, PCRF OCS realm, example [Customerirms.com]	7 to 18, 24
55	Dest Peer Host	FQDN of 3GPP AAA, PCRF, OCS host, example [njbbpcrf1a.vzims.com]	7 to 18, 24
56	CC Request Type	Example Enumerated [1-3, for I, U, T]	11, 12, 13, 15, 16, 17

IE	Description	Definition or Format Example	Applicable Procedures (from Table above)
57	CC Request Number	Example [0]	11, 12, 13, 15, 16, 17
58	Result Code	Diameter Result Code based on RFC3588, example [2001]	7 to 18, 24
59	Origin State ID	Example [1366695723]	7 through 18
60	Service Selection	AVP used for providing APN name for authorization, example [Customerinternet]	12 through 24
61	Charging Gateway Function Host	FQDN of CGF, e.g. [cgf1.NEE29.cisco.com]	5, 7
62	Charging Group ID	Charging ID of each bearer is separated by “ ” in the order same as that of IE 37 followed by 44	5, 7
63	Server-Name (CSCF Address)	Only on IMS APN, example [pcscf1.CTX07.vzims.com]	7
64	Framed-pool	Pool name from which IPv4 address is to be allocated, example [int41]	7
65	Framed-IPv6-Pool	Pool name from which IPv6 prefix is to be allocated, example [ims61]	7
66	Auth-Request-Type	Based on TS29.273 and 29.212. Example Enumerated [1-3]	7 through 24
67	Re-Auth-Request-Type	Based on TS29.273 and 29.212. Example Enumerated [0-1]	8, 14 18
68	Diameter Termination Cause	Based on TS29.273 and 29.212. Example Enumerated [1-8]	9, 13, 17
69	QoS Class Identifier	QCI, example [8]	11, 12, 15, 16
70	IP-CAN Type	Example [5 = 3GPP-EPS]	11, 12, 14
71	Event Trigger	Based on TS29.212, Series of Pipe Delimited Triggers, example [1 = QOS_CHANGE]	11, 12
72	Event Trigger		
73	Charging-Rule-Remove	Name of the removed Charging rule, example String [RTRRule3300]	12
74	Charging-Rule-Install	Name of the installed Charging rule, example String[RTRRule3300]	11
75	Multiple Services Indicator	Based on TS32.299, example Enumerated [0-1]	15 16 17

IE	Description	Definition or Format Example	Applicable Procedures (from Table above)
76	Multiple Services Credit Control Rating-Group	Identifier of Rating Troup, example [3300]	15 16 17
77	Multiple Services Credit Control Granted Service Unit	CC-Total-Octets, example [524288000]	15
78	Reserved		
79	Reserved		
80	Reserved		
81 to 170	Not applicable to P-GW		
171	User Plane IP Address	Contains User Plane IPv4 or IPv6 Address	1 through 6
172	Sx-PFCP Local SEID	Contains the SEID for CP node	1 through 6
173	Sx-PFCP Remote SEID	Contains the SEID for UP node	1 through 6
174	Sx-PFCP Cause Code	Contains the PFCP cause code	1 through 6
175	Sx-PFCP Response Time	Contains the PFCP transaction response time	1 through 6

Sx-specific Fields

Following are the new Sx-specific information which are added in S-GW and P-GW event records on CP for CUPS.

S.No.	Description	Definition	Bytes
1	User Plane IP Address	Contains User Plane IPv4 or IPv6 address	7-55
2	Sx-PFCP Local SEID	Contains the SEID for CP node	8
3	Sx-PFCP Remote SEID	Contains the SEID for UP node	8

S.No.	Description	Definition	Bytes
4	Sx-PFCP Cause Code	<p>Contains the PFCP cause code. This is per 3GPP specification 29.244 section 8.2.1.</p> <p>There can be multiple cause codes corresponding to one event record as multiple Sx transactions are involved.</p> <p>So, this is an array separated by “ ”.</p> <p>For example: 1 2 3</p>	1-5
5	Sx-PFCP Response Time	<p>Contains the Sx transaction response time in milliseconds.</p> <p>There are multiple Response time corresponding to one event record as multiple Sx transactions are involved.</p> <p>So, this is an array separated by “ ”.</p> <p>If response times-out, then fill -1</p>	4-20

Configuring Call Summary Log in CP

Following is the event record framework CLI configuration for file creation, rotation, compression, and SFTP PUSH:

```

configure
  context context_name
    session-event-module event_module_name
      file name <ser> current-prefix <curr> rotation volume <xxxxx.. xxxxxxxx>
      rotation time <xx..xxxxx> field-separator underscore include compression
      gzip
      event { transfer-mode [ pull | push { primary { encrypted-url |
url } <value> [ { encrypted-secondary-url | secondary-url } ]
[ {module-only}]] | push-interval <xx.. xxxx> | remove-file-after-transfer
| use-harddisk }
      exit
    end
  end

```

Configuring Call Summary Log in S-GW

To enable the S-GW event reporting, configure “reporting-action” under SGW service.

```
configure
  context context_name
    sgw-service service_name
      [ no | default ] reporting-action event-record
    end
```

Configuring Call Summary Log in P-GW

To enable the P-GW event reporting, configure “reporting-action” under APN.

```
configure
  context context_name
    apn apn_name
      [ no | default ] reporting-action event-record
    end
```

Verifying Call Summary Log Configuration in CP

Use the **show configuration** or **show config verbose** CLI command to verify if the feature is enabled. The following is a sample output of the command when reporting of event records is enabled.

```
config
  context context1
    apn apn1
    ...
    ...
    ...
    reporting-action event-record
```

Use the **show config verbose** CLI command to verify if the feature is disabled. The following is a sample output of the command when reporting event records is disabled.

```
config
  context context1
    apn apn1
    ...
    ...
    ...
    no reporting-action event-record
```

Monitoring and Troubleshooting

Show Command(s) and/or Outputs

This section provides information regarding show commands and/or their outputs in support of the CSL.

show session-event-module file-space-usage

The show command output displays the Event-Service module file space usage information.

CDRMOD Instance Id: 2

```

Session-Event File Storage Limit           : 33554432 bytes
Session-Event File Storage Usage          : 33554431 bytes
Percentage of Session-Event file store usage : 100.000000

```

show session-event-module statistics

The show command output displays the Event-Service module counters and statistics.

CDRMOD Instance Id: 2

Session-Event Specific Statistics:

```

Session-Event files rotated:                                0
Session-Event files rotated due to volume limit: 0
Session-Event files rotated due to time limit:             0
Session-Event files rotated due to records limit: 0
Session-Event file rotation failures:                     0
Session-Event files deleted:                              0
Session-Event records deleted:                            0
Session-Event records received:                           0
Current open Session-Event files:                         0
Time of last Session-Event file deletion:                 0

```

Session-Event Record Transfer Statistics:

```

Successful File Transfers      :           0
Failed File Transfers          :           0
Num of times PUSH initiated   :           0
Num of times PUSH Failed      :           0
Num of times PUSH cancelled
    due to HD failure         :           0
Num of periodic PUSH          :           0
Num of manual PUSH            :           0
Current status of PUSH        :           Not Running
Last completed PUSH time      :           N/A

```

show event-record statistics pgw

Displays the statistics for the event records. Below is the sample output.

```

Total number of event records: 130
GTPv2 event records: 30
    CSR: 10   CBR: 20   DSR: 0
    DBR: 0    MBR:0    UBR: 0
Diameter event records: 100
S6b Procedures:
    AAR: 10           RAR: 5
    ASR: 5           STR: 5
Gx Procedures:
    CCR-I: 10         CCR-U: 10
    CCR-T: 10         RAR: 5
Gy Procedures:
    CCR-I: 10         CCR-U: 10
    CCR-T: 10         RAR: 10

```



CHAPTER 16

Dedicated Bearer Establishment without PCRF

- [Revision History](#), on page 147
- [Feature Description](#), on page 147
- [How it Works](#), on page 147
- [Configuring active-charging-services](#), on page 151

Revision History



Note Revision history details are not provided for features introduced before release 21.24.

Revision Details	Release
First introduced	Pre 21.24

Feature Description

To provide IMS services to the UE that aren't VOLTE capable, P-GW uses the deep packet inspection (DPI) functionality to create dedicated bearers without interaction with PCRF. This helps in maintaining high QoS of the voice service although the default bearer for the internet APN gets created with interaction with PCRF.

SBC IP address (IPv4 or IPv6) and protocol RTP/RTCP are configured in ruledef and a dedicated bearer is created when a subscriber traffic matches with the ruledef without interaction with PCRF to detect voice services. If no data flows, then the dedicated bearer gets removed after the configured time limit and there's no interaction with PCRF.

How it Works

The service schema framework in CUPS supports the dedicated bearer establishment in GW when default bearer is created via PCRF. Trigger condition and trigger action are configured under service schema to create new traffic flow. For dedicated bearer establishment, the rule name configured in trigger condition must match with the rule name in the rule base configuration which is the default bearer rule name.

The predefined rule trigger action gets activated when the traffic matches with the corresponding IP and the configured port range in the rule. This results in a new dedicated bearer activation without an interaction with PCRF. If no data flows on this bearer after the predefined configured time limit then it gets deleted.

Some of the key highlights are:

- There's a separate APN for non-VoLTE UEs, to avoid creation attempt of a dedicated bearer for VoLTE UEs.
- If dedicated bearer creation fails, call continues and the traffic continues to flow on this bearer.
- Retransmission for SX_Session_Report_Request intended for dedicated bearer creation works as per existing behavior.
- Feature support is provided for P-GW/SAEGW CUPS calls only. GGSN CUPS doesn't support dedicated bearer in this release.

This section describes call flow and procedure on how the dedicated bearer is established without involving PCRF.

Figure 2: Call Flow

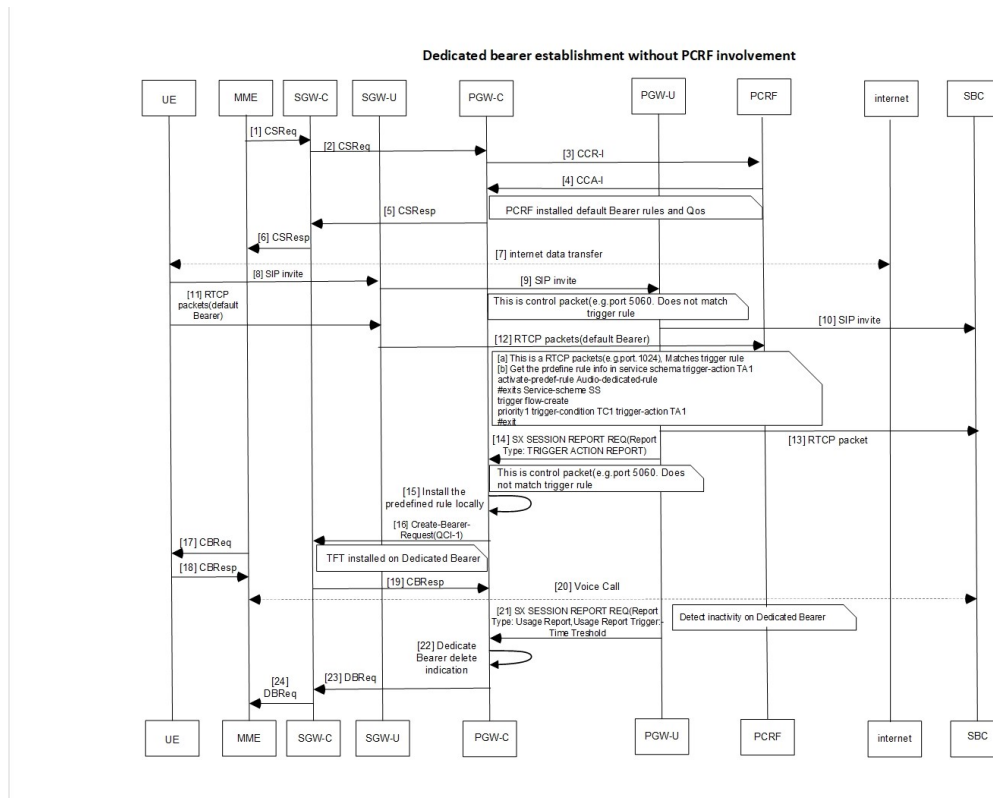

Table 1: Procedure

Step	Description
1	Establish default bearer with internet APN with PCRF.

Step	Description
2	Default Bearer receives a SIP invite and forwards to SBC. Note The port 5060/5061 receives the SIP invite, which is outside the port range for dedicated bearer.
3	An RTCP packet is received matching the SBC address and port-range that matches with the trigger rule.
4	After the rule match, UP reads the service schema and identifies the predefined rule information that is required for the creation of a dedicated bearer.
5	UP shares the rule information through SX_Session_Report_Request (for report type Trigger Action Report) with CP. CP process the request message and triggers the rule installation.
6	A dedicated bearer is created with predefined Audio_dedicated_rule and TFT with multiple ranges of port as defined by packet-filters tft1 and tft2. Note The charging-action for such rule has billing-action egcdr and content-id configured.
7	UE pushes any packets for the specified port ranges to the dedicated bearer and matches with the Audio_dedicated_rule .
8	After 300 seconds or configured timeout value of inactivity according to the threshold configuration, the bearer gets deleted and PGWCDR gets generated for a bearer with corresponding data counts. <ul style="list-style-type: none"> • You can adjust the threshold based on the keep-alive/watchdog messages. • The SIP control messages after voice call flows on the ports that are outside the port-range defined for dedicated bearer TFT. Note As UE sends SIP control messages on the default bearer, it's not considered under dedicated bearer activity. AF-Charging-Id isn't populated in dedicated bearer PGWCDR.

Sx Interface Changes

During the Post rule match activity at UP, the service schema is checked to get the predefined rule information that is required for the dedicated bearer creation. This information is shared with CP through **SX_Session_Report_Request** message enabling the CP to trigger the installation of the rule for dedicated bearer creation.

The rule information sent in **SX_Session_Report_Request** through a newly introduced session report type "TRIGGER ACTION REPORT" and SX private IE as explained below.

Table 2: Session Report Type IE

		Bits								
Octets	8	7	6	5	4	3	2	1		
1 to 2	Type = 39 (decimal)									
3 to 4	Length = n									
5	GTER	SRIR	Spare	SPTIR	UPIR	ERIR	USAR	DDDR		
6	Spare				TAR	NBUR	UPRR	STS		
7 to (n+4)	These octet(s) is/are present only if explicitly specified									

Octet 6 (present when Length>1) is encoded as follows:

- Bit 1 – STS (Subscriber Trace Status Report): When set to 1, it indicates Subscriber Trace Status Report.
- Bit 2 – UPRR.
- Bit 3 – NBUR.
- Bit 4 – TAR (Trigger Action Report): When set to 1, it indicates Trigger Action Report IE.
- Bit 5 to 8 – Spare.

Trigger Action Report IE (Private IE)

This is a conditional IE applicable only for Pure-P and Collapse call types.

Table 3: Trigger Action Report IE

		Bits								
Octets	8	7	6	5	4	3	2	1		
1 to 2	Type = 256 (decimal)									
3 to 4	Length = n									
5 to n+2	Trigger Actions									

Multiple Trigger Action IE is specified in the TAR IE. Currently, only one Trigger Action Type is packed within the Trigger Actions.

Trigger Actions

It is encoded per the following format:

Table 4: Trigger Actions

		Bits								
.										

	Octets	8	7	6	5	4	3	2	1	
	1	Trigger Action Type								
	2 to 3	Length = p								
	4 to (4+p)	Trigger Action Blob								

Trigger Action Type: Current value allowed = 1 (Rule Activate). It can be extended for different trigger action types in future.

Trigger Action Blob: It is unique as per trigger action type. For trigger action type = Activate Rule, it is:

Table 5: Trigger Action Blob

		Bits								
	Octets	8	7	6	5	4	3	2	1	
	1 to p	Rule Name								

N-1 Compatibility Matrix

The following details are part of the N-1 compatibility matrix:

SI.No	CP – UP	Behavior
1	CP and UP are on same version	SX_Session_Report_Request is handled at CP and trigger action is performed. CP must validate IE and return reject with Offending IE in case the TAR IE is not packed accurately.
2	CP is of older version (doesn't understand TAR in Sx Session Report Req)	UP sends the SX_Session_Report_Request with TAR bit. CP ignores this SX_Session_Report_Request and sends as success to UP.
3	Newer CP version	Older version of UP never triggers SX_Session_Report with TAR bit = 1, so no handling is needed. However, CP must validate the IE and reject with Offending IE in case the TAR IE is not packed accurately.

Configuring active-charging-services

Use the following example configuration to establish a dedicated bearer without interaction with PCRF.

```
config
  active-charging service acs
    ruledef Audio_dedicated_rule
      ip dst-address = 209.165.200.224/27
    #exit
    ruledef trigger_rule
      ip dst-address = 209.165.200.224/27
      udp either-port range 1024 to 5059
```

```

    udp either-port range 5062 to 43672
#exit
packet-filter tft1
    ip remote-port range 1024 to 5059
    ip remote-address = 209.165.200.224/27
#exit
packet-filter tft2
    ip remote-port range 5062 to 43672
    ip remote-address = 209.165.200.224/27
#exit
charging-action no_charge
#exit
charging-action ca_audio
    content-id 2
    billing-action egcdr
    qos-class-identifier 1
    flow limit-for-bandwidth direction downlink peak-data-rate 256000 peak-burst-size
32000 violate-action discard
    flow limit-for-bandwidth direction uplink peak-data-rate 256000 peak-burst-size 300000
violate-action discard
    allocation-retention-priority 4 pvi 1 pci 1
    tft packet-filter tft1
    tft packet-filter tft2
#exit
rulebase prepaid
    billing-records egcdr
#Install Audio_dedicated_rule on dedicated bearer to cater to VoLTE traffic
    action priority 1 dynamic-only ruledef Audio_dedicated_rule charging-action ca_audio
#Use traffic matching to trigger_rule on default bearer as trigger condition
action priority 2 ruledef trigger_rule charging-action no_charge
#exit
trigger-action TA1
    #activate-predef-rule Audio_dedicated_rule
#exit
trigger-condition TC1
    rule-name = trigger_rule
#exit
trigger-condition tc
    rulebase = prepaid
#exit
service-scheme SS
    trigger flow-create
        priority 1 trigger-condition TC1 trigger-action TA1
    #exit
subs-class SC1
    rulebase = prepaid
#exit
subscriber-base sb
    priority 1 subs-class SC1 bind service-scheme SS
#exit
#exit
context egress
    apn internet
#Remove dedicated bearer after 300 seconds of inactivity
    timeout bearer-inactivity gbr 300 volume-threshold total 1
active-charging rulebase prepaid
    exit
exit
end

```



CHAPTER 17

Device ID in EDNS0 Records

- [Revision History](#), on page 153
- [Feature Description](#), on page 153
- [How it Works](#), on page 154
- [Configuring EDNS Format and Trigger Action](#), on page 157
- [Monitoring and Troubleshooting](#), on page 160

Revision History



Note Revision history details are not provided for features introduced before release 21.24.

Table 6: Revision History

Revision Details	Release
The feature is supported in 21.25 and later releases.	21.25
First introduced.	Pre 21.24

Feature Description

The Device ID in EDNS0 offers each enterprise with a customized domain blocking through Umbrella.

To enable the Device ID in EDNS0 functionality:

- The UP must reformat a subscriber DNS request into an EDNS0 request.
- The UP must include an Umbrella "Device ID" in the EDNS0 packet so that the Umbrella DNS resolver can use the Device ID to apply the domain filter associated or configured with the Device ID in the EDNS0 packet.

The Control Plane (CP) receives the domain filtering policy ID from PCRF or PCF. The CP passes the domain filtering policy ID to the User Plane (UP) in Subscriber Parameters. The UP uses the domain filtering policy ID to apply domain filtering functionality to the subscriber.

How it Works

The EDNS0 packet receives the 64-bit device ID as OPT RR data. The first 32 bits of all device IDs is a fixed value configured in the UP. The last 32 bits of a subscriber device ID is the content filter ID value received from PCRF or PCF. The UP concatenates the two 32-bit values to build a subscriber-full 64-bit Device ID for populating the subscriber EDNS0 queries. The CLI command configures the first 32 bits of static Device ID value. If you do not configure the 32-bit static prefix CLI command, the outgoing packet displays the device-ID = 32-bit CF PolicyID.

The Device ID number in the EDNS0 record allows the Umbrella DNS system to apply a custom set of domain filters for the EDNS0 queries.

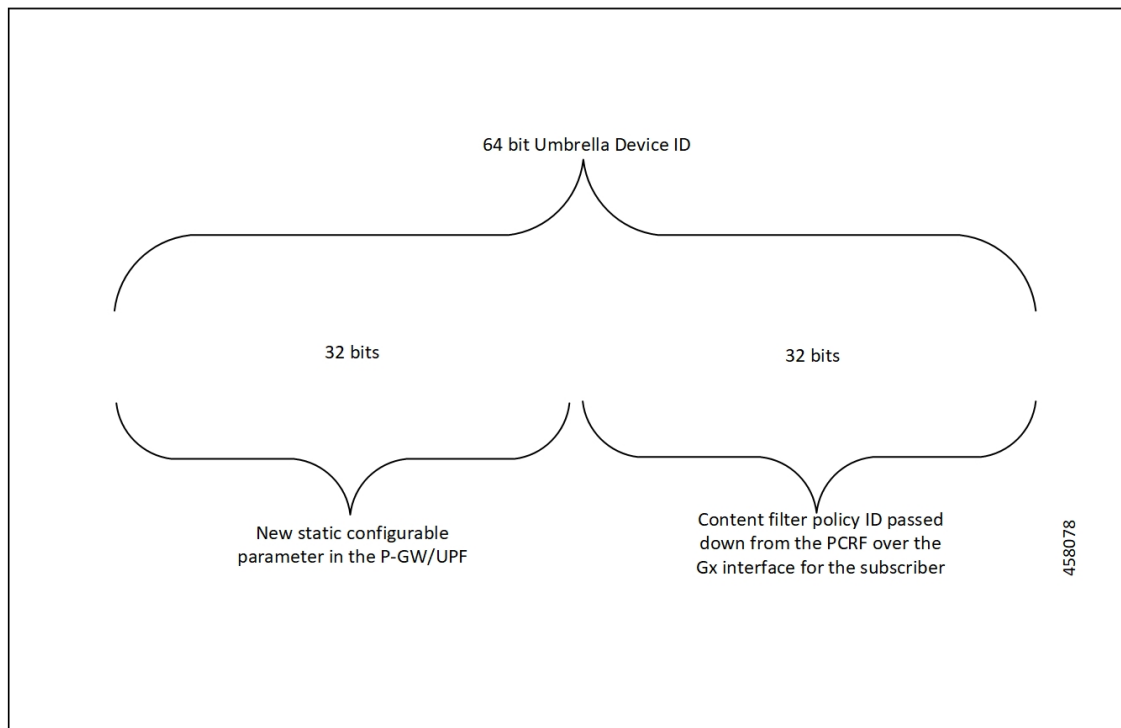

Process Flow

The following process flow describes the Content Filtering enhancement to insert Device ID in EDNS0 records:

Figure 3: Inserting Device ID in EDNS Records

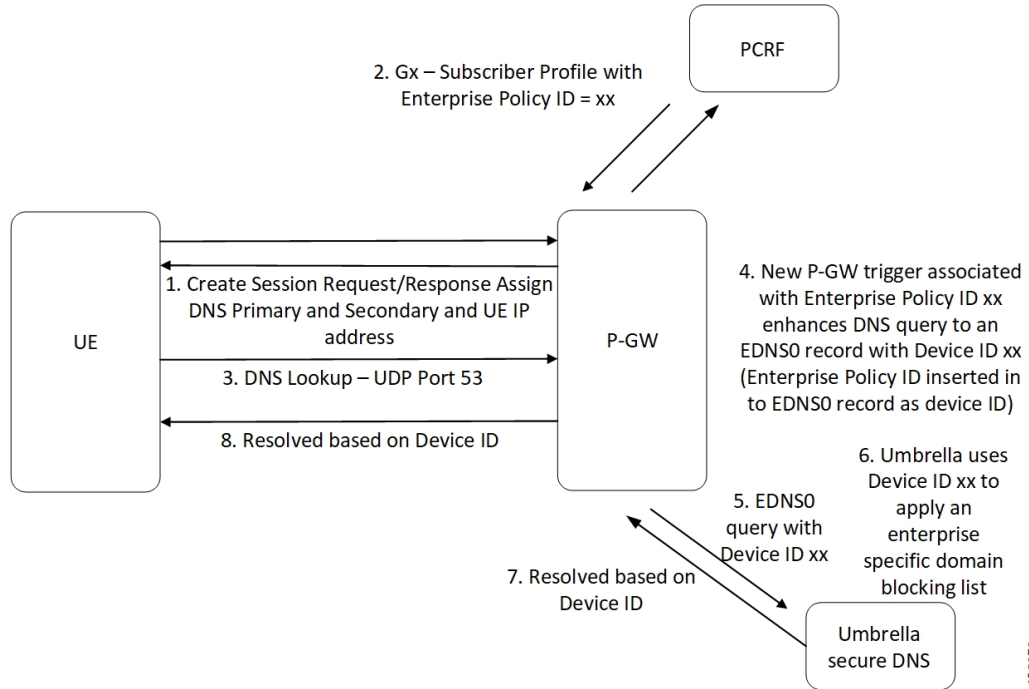

458079

EDNS0 Packet Format

The enterprise policy ID (CF_POLICY_ID) from PCRF helps to create the Device ID. The CP sends the Device ID to the UP. Adding the Device ID to the DNS packet helps in creating the EDNS0 packet. The format of EDNS0 packets is specified by RFC2671.

The following are specifics of the packet format:

- The following is the structure for the fixed part of an OPT RR:

Field Name	Field Type	Description
NAME	domain name	empty (root domain)
TYPE	u_int16_t	OPT
CLASS	u_int16_t	sender's UDP payload size
TTL	u_int32_t	extended RCODE and flags
RDLLEN	u_int16_t	describes RDATA
RDATA	octet stream	{attribute, value} pairs

- The following is the variable part of an OPT RR encoded in its RDATA:

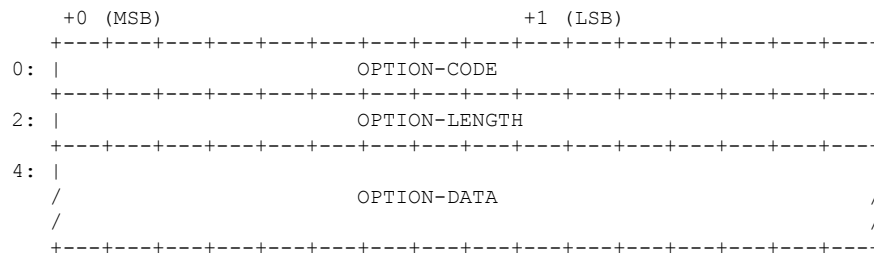

- OPTION-CODE: Assigned by IANA

- OPTION-LENGTH: Size (in octets) of OPTION-DATA
- OPTION-DATA: Varies as per OPTION-CODE

Example:

If the policy-id received from PCF or PCRF is "1234" and static prefix configured on UP is "5678", the 64-bits Device-ID will be "0000162e000004d2".

- 0000162e -- 5678 (decimal)
- 000004d2 -- 1234 (decimal)

RDATA 69 42 00 0f 4f 70 65 6e 44 4e 53 00 00 16 2e 00 00 04 d2

- 6942 -- option-code
- 000f -- option-length
- 4f70656e444e53 -- OpenDNS (string)
- 0000162e -- 5678 (MSB)
- 000004d2 -- 1234 (LSB)

EDNS0 with IP Readdressing

The CLI command configured within trigger action readdresses the DNS traffic to the Umbrella DNS. This CLI uses the existing readdress-server list configuration from the ACS service. Readdressing of packets based on the destination IP address of the packets enables redirecting gateway traffic to configured server or port in the readdressed-server list.

Behavior and Restrictions

This feature has the following behaviors and restrictions:

- Evaluates the trigger condition at flow creation time. Any change in the trigger condition in between the flow does not affect the existing flow but affects the new flows.
- Any change to trigger action is applicable on the same flow.
- Neither CF nor EDNS is enforced when the CF Policy ID range is defined but service-schema is not defined, or the trigger condition pertaining to EDNS is not configured.
- If no CF Policy ID is received from Gx, range check is not performed, and content filtering works as defined in rule base.
- Cases where the "security-profile" CLI command is not associated with the EDNS format CLI under trigger action, the Device ID in the outgoing EDNS packet is sent only with the 32-bit CF Policy ID.
- DNS queries with type other than A, AAAA, CNAME, NS, PTR, SRV, TXT, NULL must not be EDNS converted.
- CF Policy ID change over Gx in between inflows is not applicable for the current flows. The current flows continue to insert the CF Policy ID present at the time of flow creation.

Limitations

This feature has the following limitations:

- Does not support the EDNS response packet reformat.
- The UP must be able to include the IMSI MSISDN tag value in the EDNS0 queries. This feature does not support the encrypted IMSI in EDNS0 packet and also the EDNS fields in the following configuration.

```

configure
  active-charging-service service_name
    edns
      fields fields_name
        tag default device-id
        tag 101 imsi encrypt
        tag 102 pgw-address
      end

```

Configuring EDNS Format and Trigger Action

Configuring DNS Filter

Use the following configuration to enable or disable DNS filtering:

```

configure
  active-charging-service service_name
    content-filtering range start_min_val to end_max_val
    no content-filtering range
  end

```

NOTES:

- If the range parameter is set from 10 to 1000, any subscriber profile with a content filtering policy ID from 10 to 1000 uses the standard content filtering functionality. Any subscriber profile with a content filtering policy ID higher than 1000 or lower than 10 triggers the EDNS0 functionality.
- When DNS filtering is disabled, the standard content filtering policies resume as configured or as received from PCF.

Configuring EDNS Packets

Use the following configuration to configure the EDNS packet action and format under the active-charging service:

```

configure
  active-charging-service service_name
    trigger-condition trigger_condition_name
    external-content-filtering
      app-proto = dns
    end

```

NOTES:

- **external-content-filtering**: Enable the EDNS0 feature when this flag is set to true along with the range criteria. By default, this flag is disabled.
- **app-proto = dns**: Avoid IP readdressing of non-DNS traffic. If this command is enabled with multiline-or CLI, then all DNS traffic is EDNS encoded.

The following configuration defines the EDNS format to be inserted in the EDNS packet:

```
configure
  active-charging-service service_name
    trigger-action trigger_action_name
      edns-format format_name
        security-profile profile_name
          flow action readdress server-list server_list_name [ hierarchy ]
        [ round-robin ] [ discard-on-failure ]
      end
end
```

NOTES:

- **trigger-action** *trigger_action_name*: Enable the flow-action CLIs under trigger action.
- **edns-format** *format_name*: Use the EDNS format when EDNS is applied.
- **security-profile** *profile_name*: Define the security profile configuration in EDNS to add the Device-ID mapping.



Note This feature supports multiple security profiles.

- **flow action readdress server-list** *server_list_name* [**hierarchy**] [**round-robin**] [**discard-on-failure**]: Associate EDNS with IP readdressing. IP readdressing is used to readdress the packets to the configured server IPs. This CLI under trigger action supports only the server list configuration. It does not support single-server IP or port configuration such as charging-action.

Inserting CF Policy ID

Use the following configuration to insert the CF policy ID in EDNS:

```
configure
  active-charging-service service_name
    edns
      fields fields_name
        tag { val { imsi | msisdn | cf-policy-id } }
      end
end
```

NOTES:

- To configure the 32-bit, static value is provided at the EDNS level with the security profile.

```
security-profile security_profile cf-policy-id-static-prefix value
```
- To insert a new tag, specify the payload length value as an integer in the range 576 to 4096:

```
tag default payload-length [ tcp | udp ] value
```

Sample Configuration

The following is a sample configuration for configuring the EDNS packets:

```
configure
  active-charging service ACS
  content-filtering range 10 to 100

  ruledef dns-port
    udp either-port = 53
    tcp either-port = 53
    multi-line-or all-lines
    rule-application routing
  #exit

  readdress-server-list re_adr_list_ta
    server 100.100.100.14
    server 2001::14
    server 100.100.100.15
    server 2001::15
  #exit

  rulebase test
    route priority 20 ruledef dns-port analyzer dns
  #exit

  edns
    security-profile sec_profile cf-policy-id-static-prefix 123456
    fields test_fields
      tag 26946 cf-policy-id
    #exit

    format test_format
      fields test_fields encode
    #exit

    trigger-action TA1
      edns format test_format security-profile sec_profile
      flow action readdress server-list re_adr_list_ta hierarchy
    #exit

    trigger-condition TC1
      external-content-filtering
      app-proto = dns
    #exit

    service-scheme SS1
      trigger flow-create
      priority 1 trigger-condition TC1 trigger-action TA1
    #exit

    subs-class SC1
      rulebase = test
      multi-line-or all-lines
    #exit

    subscriber-base SB1
      priority 1 subs-class SC1 bind service-scheme SS1
    #exit
end
```

Monitoring and Troubleshooting

Following are the show commands and outputs in support of enhance content filtering support to Insert device ID in EDNS0 records.

Show Commands and Outputs

The following show commands and outputs are modified in support of this feature:

show user-plane-service inline-services info

```
CF Range: Enabled
  Start Value: 1
  End Value: 1000
```

show user-plane-service statistics analyzer name dns

```
EDNS Over UDP:
EDNS Encode Success:          0          EDNS Encode Failed:      0
EDNS Encode Success Bytes:    0
EDNS Response Received:       0

EDNS Over TCP:
EDNS Encode Success:          0          EDNS Encode Failed:      0
EDNS Encode Success Bytes:    0
EDNS Response Received:       0
```

show subscribers user-plane-only full callid <call_id>

```
DNS-to-EDNS Uplink Pkts:      0          DNS-to-EDNS Uplink Bytes:  0
EDNS Response Received:       0
```

show user-plane-service edns all

```
Fields:
  Fields Name: fields_1
  tag 26946 cf-policy-id

  Fields Name: fields_2
  tag 2001 imsi
  tag 2002 msisdn
  tag 26946 cf-policy-id

Format:
Format Name: format_1
fields fields_1 encode

Format Name: format_2
fields fields_2 encode

Security-profile Name: high
CF Prefix Policy ID: 1234
```

Trigger Action Statistics

Use the following show commands to view the trigger action statistics:

- **show user-plane-service statistics trigger-action all**

```
Trigger-Action: TA1
Total EDNS PKTS      : 1
Total readdressed Flows : 1
Total Trigger action(s) : 1
```

- **show user-plane-service statistics trigger-action name *trigger_action_name***

```
Trigger-Action: TA1
Total EDNS PKTS      : 1
Total readdressed Flows : 1
Total Trigger action(s) : 1
```

- **show user-plane-service trigger-condition all**

```
Trigger-Condition: TC1
External-content-filtering : Enabled
App-proto : dns
Multi-line-OR All lines : Disabled
```

- **show user-plane-service trigger-action all**

```
Trigger-Action: TA1
HTTP Response Based TRM      : none
HTTP Response Based Charging : none
Throttle Suppress            : Disabled
Flow Recovery                 : Disabled
Traffic Optimization         : Disabled
Step Up GBR                  : Disabled
Step Down GBR                : Disabled
TCP Acceleration             : Disabled
TCP Acceleration Threshold   : Disabled
Service-Chain                : none
UP-Service-Chain             : none
EDNS-Encode                  : Enabled
Flow-IP-Readdressing         : Enabled
```

Bulk Statistics

This feature supports the following bulk statistics in the ECS schema:

Table 7: ECS Schema

Statistics	Description
ecs-dns-udp-edns-encode-succeed	The number of DNS to EDNS converted packets over UDP.
ecs-dns-udp-edns-encode-failed	The number of failed DNS to EDNS conversions over UDP.
ecs-dns-udp-edns-encode-response	The number of responses received for EDNS query over UDP.
ecs-dns-tcp-edns-encode-succeed	The number of DNS to EDNS converted packets over TCP.
ecs-dns-tcp-edns-encode-failed	The number of failed DNS to EDNS conversions over TCP.
ecs-dns-tcp-edns-encode-response	The number of responses received for EDNS query over TCP.



CHAPTER 18

DI-Net Encryption

- [Revision History, on page 163](#)
- [Feature Description, on page 163](#)
- [How it Works, on page 163](#)
- [Configuring Encryption Algorithm, on page 166](#)
- [Appendix, on page 166](#)

Revision History

Revision Details	Release
First introduced.	21.27.4

Feature Description

The VPC-DI systems use Advanced Encryption Standard Cipher Block Chaining (AES CBC) algorithm to encrypt the traffic flowing between different cards. However, the CBC algorithm has one drawback as it uses an unauthenticated encryption mode there is a possibility of attackers tampering with the encrypted traffic at any given point in time. To avoid this issue an authenticated encryption algorithm is used which provides better protection and aids in data integrity.

The Galois or Counter Mode (GCM) encryption algorithm supports authenticated encryption mode which helps in overcoming this vulnerability. Also on the decrypting side, GCM uses Additional Authentication Data (AAD) to authenticate the payload.

How it Works

Since the GCM encryption algorithm is authenticated, it is used in the DI-Net traffic encryption process. It is highly secure, and the same Initialization Vector (IV) is never repeated for any given key value. The *param.cfg* file is used to configure the encryption algorithm.

Both Cipher Block Chaining (CBC) and GCM algorithms use block cipher and Exclusive OR (XOR) logic with distinct internal functions.

The CBC encryption process consists of XORing the previously encrypted blocks known as cipher texts with the unencrypted blocks known as plain text and then encrypting the resultant block with a block cipher. Decrypting of encrypted data or cipher text using a block cipher and by XORing the resultant block with the previous cipher text block, yields the plain text data.



Note The first block is treated as a special case as it does not belong to any previous block and uses the IV instead of the previous block data.

The GCM algorithm is a combination of counter mode encryption and authentication (CTR + Auth). It combines the Galois field multiplication with the counter mode of operation for block ciphers and aids in the conversion of block ciphers into stream ciphers. Each block is encrypted with a key stream's pseudo random value. Because of the successive increment of IV values, each block is encrypted with a unique value which is never repeated.

The Galois field multiplication component considers each block as its own finite field for encryption based on the Advanced Encryption Standard (AES) standard. The AES GCM incorporates handshake authentication with additional data authentication. Also, the GCM encryption or decryption process can also be parallelized anytime, and the built-in authentication makes it resistant to payload tampering and to paddle oracle attacks due to which it is preferred over the CBC algorithm.

AES-CBC-256

The master Control Function (CF) card generates the encrypted password using **openssl**. The CF card is solely responsible for creating the passwords and secret codes that all of the cards use during the boot-up process. All passwords have the slot numbers appended to them, during the key and IV generation process. Any card is allowed to generate the key and IV of any other card. The same process is followed for creating the dynamic IV table as well. The keys are of length 256 bits each and the IVs are of length 128 bits.

During the encryption process, the source card uses its own key whereas the IV is generated at random. The source card's corresponding IV is XORed with an IV from the dynamic IV table which is selected based on the hash function output, which includes the source and destination addresses of the IP header as well as a random number. This random number is included in the crypto header.

During the decryption process, the destination card uses the source card slot number to select the key and source address along with the destination address and a random number from the headers, before selecting the IV.

AES-GCM-256

To change the encryption algorithm to **aes-gcm-256**, the encryption function requires Additional Authentication Data (AAD) as an additional input for the encryption algorithm. It can be anything that is forwarded between the source and the destination which ensures the key and IV pair are never re-used. The GCM security requires this function to be highly compliant. If by any chance an IV is repeated for any or all instances of the authenticated encryption function which is having a key, then the entire implementation turns vulnerable for forgery attacks.

While encrypting the packet with GCM, the source card selects a key which is like the CBC algorithm, but the IV is selected based on a mechanism that ensures that the selected IV is unique and has never been used before, for any particular key. The AAD is included in the crypto header and once the encryption is complete, the authentication tag 'T' is added to the encrypted data before it is transmitted with the payload.

During the decryption process, the packet using GCM, the key and IV are selected using a similar mechanism like in the encryption process and the authentication tag is removed from the encrypted data. The AAD, the key and the IV are all used to decrypt the payload. If the authentication tag generated after decryption, matches with the authentication tag received from the source, then the integrity of data is ensured, and the decryption process is successful.

Encryption Method (iftask_aes_gcm_encrypt)

The new encryption method is given below:

- Determine the source card's slot number.
- Select the key and IV for this slot from the stored values.
- Generate a random number.
- Generate the *hash_index* for selecting from the dynamic IV table using source IP address, destination IP address and the random number.
- Generate the final IV by XORing the source cards IV with the IV from the dynamic IV table and then ORing it with the random number. This ensures that the final IV is unique for the key and the same key, IV pair is never re-used.



Note The size of the dynamic IV table is 64 and the random number is *uint16_t*.

- Select the IP fragment offset value as additional authentication data.
- Encrypt using the selected or generated key, IV and AAD.
- Fill the crypto header with the generated random number.

Decryption Method (iftask_aes_gcm_decrypt)

The new decryption method is given below:

- Determine the source card's slot number.
- From the stored values, select the key and IV for the source slot.
- Get the random number from the crypto header.
- Create the *hash_index* to select from the dynamic IV table, using the source IP address, destination IP address and the random number.
- Generate the final IV by XORing the IV of the source cards with the IV from the dynamic IV table and ORing it with the random number.
- Choose the IP fragment offset value as additional authentication data.
- Use AAD to authenticate the received payload.
- Proceed with encryption using the selected or generated key, IV and AAD.

Limitations

The following are the known limitations and restrictions of this feature:

- This feature is limited to the CUPS-DI systems only and not all VPC-DI systems.
- The change in encryption algorithm requires a reload. The algorithm can be modified by either manually modifying the `/boot1/param.cfg` file or by using the new CLI to change the algorithm, before reloading and then initiating a reload.
- Only reloading with the preferred algorithm in the boot config without performing any changes before the reload will not lead to any change in the algorithm, as the encryption algorithm needs to be set before the card boot up process.
- The impact of the authentication algorithm on performance must be assessed due to any computational overheads of **aes-gcm-256** for smaller packets.

Configuring Encryption Algorithm

The encryption algorithm is configured through the boot parameter file, during the card boot up process. A new boot flag value `DI_NET_ENC_ALG` is available in the `/boot1/param.cfg` file as the boot option during configuration.

The flag can be set using the CLI below or by manually editing the `/boot1/param.cfg` file. If it is set manually, it must be set to the same value in every CF and SF card for active and standby. 0 is for CBC, by default and 1 is for GCM.



Note For the changes to take effect, the CP has to be reloaded every time the encryption algorithm is changed.

Use the following configuration to configure the encryption algorithm in CUPS:

```
configure
  iftask di-net-encrypt-alg di_net_encrypt_alg
end
```

NOTES:

- **di-net-encrypt-alg**: Configures the encryption algorithm for the Di-LAN traffic. It represents the encryption algorithm name.

Appendix

Cipher Block Chaining

When plain text blocks are combined with cipher text blocks during encryption, in a confidential mode it is referred to as CBC. The CBC requires an unpredictable IV, which does not have to be a secret always to combine with the first plain text block.

Each plain text block is XORed with the previous cipher text block, making each cipher text block dependent on the plain text block before encryption, at any given point in time. To be unique each message IV must be used in the first block.

Figure 4: Cipher Block Chaining Method

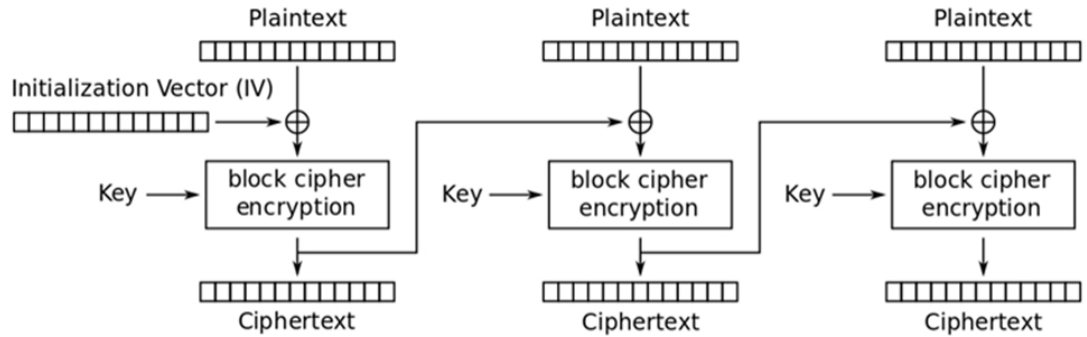

Cipher Block Chaining (CBC) mode encryption

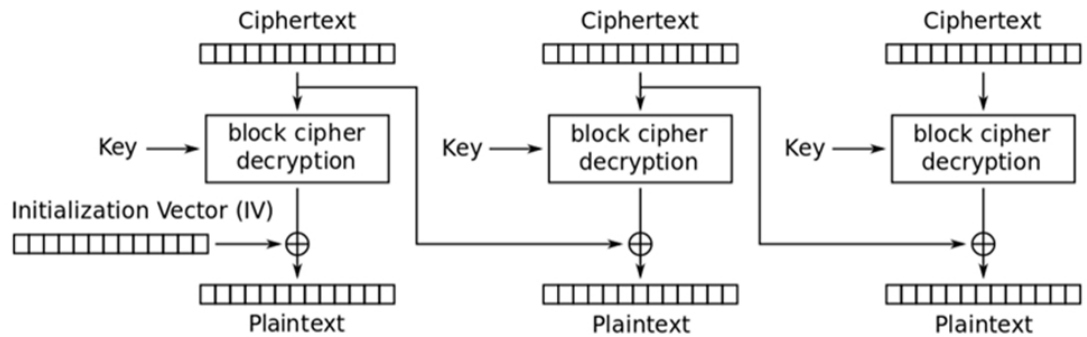

Cipher Block Chaining (CBC) mode decryption

468142

Galois or Counter Mode

GCM combines the counter mode of encryption with the new Galois authentication mode. The key feature is the ease with which the Galois field multiplication used for authentication can be parallelized.

The two functions that comprise GCM are called authenticated encryption and decryption. The authenticated encryption function encrypts the confidential data and computes an authentication tag on both the confidential data and any additional, non-confidential data. The authenticated decryption function decrypts the confidential data, contingent on the verification of the tag.

Once a block cipher and key are selected and approved, the encryption function accepts the three input strings given below:

- Plain text, denoted as P.
- Additional Authenticated Data (AAD).
- Initialization Vector (IV).

GCM protects two types of data, the plain text and the AAD, by ensuring their authenticity. It also protects the confidentiality of the plain text while leaving the AAD transparent. The IV is a unique value that calls the authenticated encryption function on the input data that is to be protected.

The input string's bit length in the encryption algorithm must be within the limits given below:

- Length of $P \leq 239-256$
- Length of $A \leq 264-1$
- $1 \leq \text{Length of IV} \leq 264-1$

The inputs for the authenticated encryption function are IV, AAD, secret key and plain text and the output is the cipher text having the same bit length as that of the plain text with the authentication tag T.

After approving and selecting a block cipher, key, and associated tag length, the IV, additional authenticated data A, cipher text C and authentication tag T are fed as inputs to the authenticated decryption function. The decryption process produced the outputs as follows:

- The plaintext P corresponding to the cipher text C.
- A special error code.



Note The output P indicates whether or not the authentication tag T for IV, A, and C was successful, otherwise the decryption process is considered as failed.

Figure 5: Galois or Counter Mode Method

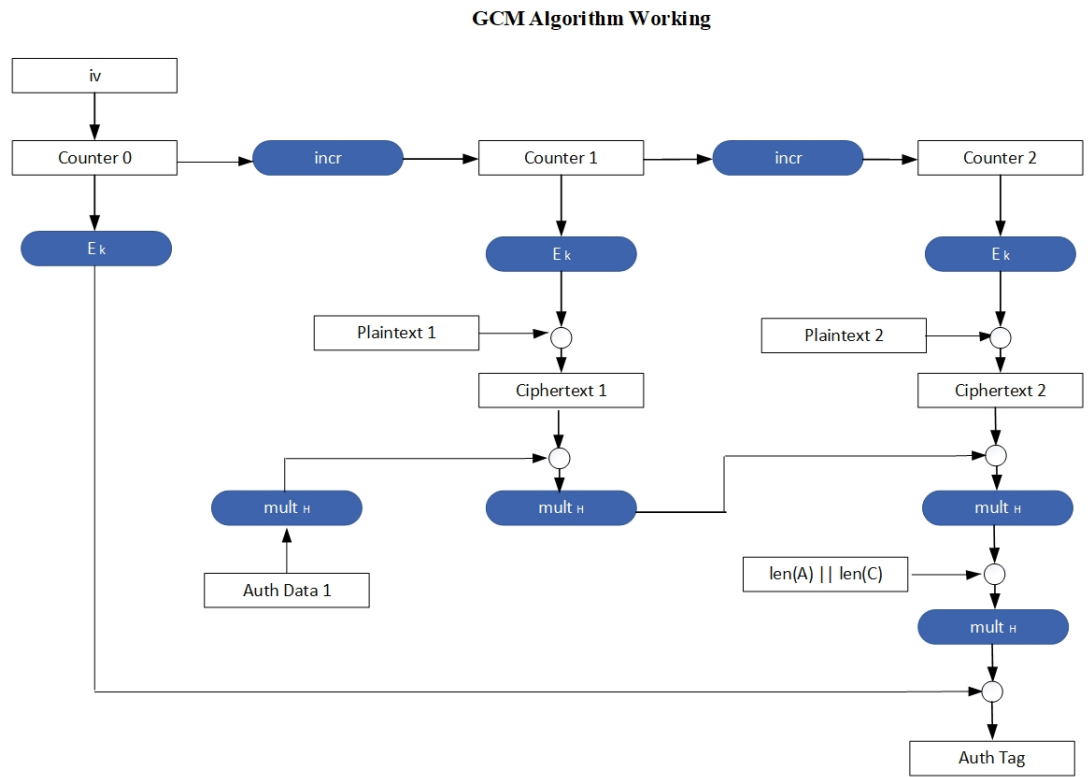

468074



CHAPTER 19

Disable Radius Accounting

- [Revision History, on page 171](#)
- [Feature Description, on page 171](#)
- [Configuring RADIUS Accounting on Dedicated Bearer Feature, on page 172](#)

Revision History



Note Revision history details are not provided for features introduced before release 21.24.

Revision Details	Release
First introduced	Pre 21.24

Feature Description

RADIUS is a distributed client or server system that secures networks against unauthorized access. In the Cisco implementation, the RADIUS clients run on Cisco devices and send authentication requests to a central RADIUS server that contains all user authentication and network service access information.

CUPS supports disabling RADIUS accounting on dedicated bearers for RADIUS server.

CUPS supports the following functionality:

- Enabling RADIUS accounting for all bearers
- Disabling RADIUS accounting for a specific dedicated bearer based on its QCI and ARP value
- Enabling RADIUS accounting only for the default bearer while disabling RADIUS accounting for all the dedicated bearers
- URRs are not created for bearers that have their RADIUS accounting disabled
- CLI configuration changes apply only to new calls made after the configuration change and do not affect existing calls.

- If the RADIUS accounting for a particular bearer is disabled or enabled, it applies to bearers created after it was disabled or enabled, and not for existing bearers

NOTE: This functionality is also available for products that use RADIUS in non-CUPS architecture.

Configuring RADIUS Accounting on Dedicated Bearer Feature

This section describes the CLI configurations for:

- Enabling RADIUS accounting for all bearers
- Disabling RADIUS accounting for a specific dedicated bearer based on its QCI and ARP value
- Enabling RADIUS accounting only for the default bearer while disabling RADIUS accounting for all the dedicated bearers

Enabling RADIUS Accounting for All Bearers

To enable RADIUS accounting for all the bearers, use the following CLI configuration.

```
configure
  context context_name
    aaa group group_name
      radius accounting mode all-bearers
    end
```

NOTES:

- The **radius accounting mode all-bearers** CLI command is enabled by default.

Disabling RADIUS Accounting for a Specific Bearer

To disable RADIUS accounting for a specific dedicated bearer based on its QCI and ARP values, use the following CLI configuration.

```
configure
  context context_name
    aaa group group_name
      radius accounting disable-bearer qci qci_value arp-priority-level
      arp_value
    end
```

NOTES:

- The **radius accounting disable-bearer qci qci_value arp-priority-level arp_value** CLI command disables RADIUS accounting only for the dedicated bearer with the specified QCI and ARP values. Accounting of other dedicated bearers is not affected.
- The maximum number of QCI and ARP combination configurations allowed to disable RADIUS accounting on dedicated bearers is 16. If you try to configure more than 16 combinations, the following error message is displayed:

```
Failure: Error!!! Maximum 16 qci and arp combinations allowed.
```

Enabling RADIUS Accounting only for the Default Bearer

To enable RADIUS accounting only for the default bearer, and disable RADIUS accounting for all the dedicated bearers, use the following CLI configuration.

```
configure
  context context_name
    aaa group group_name
      radius accounting mode default-bearer-only
    end
```

NOTES:

- The **radius accounting mode default-bearer-only** CLI command enables RADIUS accounting only for the default bearer and disables RADIUS accounting for all the dedicated bearers.
- To remove the **radius accounting disable-bearer qci *qci_value* arp-priority-level *arp_value*** configuration for a specific dedicated bearer, and allow RADIUS accounting for that dedicated bearer, use the **no radius accounting disable-bearer qci *qci_value* arp-priority-level *arp_value*** CLI command.
- When RADIUS accounting mode is set to default-bearer-only, you cannot disable RADIUS accounting on a dedicated bearer. If you run the **radius accounting disable-bearer qci *qci_value* arp-priority-level *arp_value*** CLI command, the following error message is displayed:

```
Failure: Error!!! Radius accounting mode is set to default-bearer-only. Change the mode to all-bearers and run this CLI again
```



CHAPTER 20

DSCP Markings For Collapse Calls

- [Feature Summary and Revision History, on page 175](#)
- [Feature Description, on page 175](#)
- [How It Works, on page 176](#)
- [Configuration, on page 176](#)
- [Monitoring and Troubleshooting, on page 177](#)
- [Show Commands Outputs, on page 177](#)
- [SMGR CP Changes, on page 177](#)

Feature Summary and Revision History



Note Revision history details are not provided for features introduced before release 21.24.

Revision Details	Release
First introduced	Pre 21.24

Feature Description

Currently QCI-based DSCP markings are applicable for Pure-S and Pure-P calls. The DSCP markings are based on QCI-QOS-Mapping associated with respective S-GW service or P-GW service. For collapse calls QCI-QOS-Mapping associated with PGW-service is applicable. This feature helps to apply the DSCP markings for collapse calls based on associated S-GW and P-GW services for uplink and downlink traffic. For uplink traffic DSCP markings associated with logical P-GW service is applicable. For downlink traffic DSCP markings associated with logical S-GW service is applicable. The DSCP markings are present in IP header of data traffic as a part of GTPU header and Inner IP. There's option to enabled or disable this functionality by CLI configuration. When you enable the feature, then only the new functionality is applicable otherwise existing functionality also works. By default, this feature is disabled so that there's no impact on customers who upgrades to this feature.

How It Works

Following are the steps that describes the DSCP markings for the collapse calls.

- In case of Collapse call:
 - for ACCESS side QCI-QOS mapping table associated with SGW-service is used.
 - For CORE side QCI-QOS mapping table associated with PGW-service is used.
- This is applicable once you enable the feature, otherwise QCI-QOS mapping table associated with PGW-service is used for both sides.
- APN associated QCI-QOS mapping table is preferred over the P-GW service QCI-QOS mapping table.
- APN-Profile associated QCI-QOS mapping table is preferred over SGW-Service QCI-QOS mapping table for ACCESS side DSCP markings.
- In case only P-GW service has QCI-QOS mapping table configuration then these DSCP markings is applicable on both ACCESS & CORE side for collapse call.
- In case only S-GW service has QCI-QOS mapping table configuration then these DSCP markings is applicable on ACCESS side for collapse call.
- There is a new configurable parameter inside the SAE-GW service which indicates whether the feature is enabled or disable.
- For Pure-P to Collapse HO and vice-versa, transport layer markings are updated in FAR as a part of Sx Modify request.
- Layer2 markings are also modified based on QCI-QOS mapping table picked for ACCESS & CORE side.
- DSCP markings continues to apply on existing bearers post session recovery.
- DSCP markings continues for the bearers on standby chassis once it switches to active mode.

Configuration

Configure the following command inside the SAE-GW service to enable/disable this feature.

```
configure
    context egress
        saegw_service saegw_service
        downlink-dscp-per-call-type enabled/disabled
    end
```



Note When you enable the feature, use the S-GW service QCI-QOS mapping DSCP markings for downlink, if call type collapses. By default, the downlink-DSCP-per-call-type is Disabled.

Monitoring and Troubleshooting

This section provides information on CLI commands that are available for monitoring and troubleshooting for DSCP markings for collapse calls.

Show Commands Outputs

This section provides information about show CLI commands that are available in support of DSCP markings for collapse calls.

show saegw-service all

This show command is to check if the feature is enabled or Disabled.

```
Service name : SAEGW11
Service-Id : 47
Context : EPC1
Status : STARTED
sgw-service : SGW11
pgw-service : PGW11
sx-service : SX11C
User Plane Tunnel GTPU Service : SAEGW11SXU
Newcall policy : n/a
downlink-dscp-per-call-type : enabled
CUPS Enabled : Yes
Service name : SAEGW21
Service-Id : 25
Context : EPC2
Status : STARTED
sgw-service : SGW21
pgw-service : PGW21
sx-service : SX21C
User Plane Tunnel GTPU Service : SAEGW21SXU
Newcall policy : n/a
downlink-dscp-per-call-type : disabled
CUPS Enabled : Yes
```

show sub user-plane-only callid <call_id> far full all

Use this User Plane CLIs to validate the Transport level marking options and inner packet markings for UPLINK/DOWNLINK FAR.

SMGR CP Changes

DSCP markings for Uplink/CORE and Downlink/ACCESS are present at bearer level inside `sessmgr_sub_session_t` → `sessmgr_qci_tab_t`.

User datagram DSCP markings are updated in IP header of inner packet, that is packet sent from UE to Internet and vice/versa.

Encaps header DSCP markings are updated in IP header of outer IP layer having GTPU-header (Outer header).

DSCP markings are sent from CP to UP inside FAR IE as follows:

- Transport Level Marking - The DSCP markings is configured in encaps header for ACCESS side and User-datagram on CORE side for collapse call.
- Transport Level Marking Options - Includes two options and are applicable only for outer header:
 - Copy-inner: Copy the inner packets markings to outer header
 - Copy-outer: Relay the DSCP markings for outer header

Inner Packet Marking - DSCP markings is configured in user datagram for ACCESS side. For CORE side it is N/A for collapse call.

Logic to fetch the DSCP marking changed for collapse call:

- Fetch the DSCP markings based on qci & qrp_pl for session from the associated SGW-Service for ACCESS/downlink side.
- Fetch the DSCP markings based on qci & qrp_pl for session from the associated PGW-Service for CORE/uplink side.
- For ACCESS/downlink side qci-qos mapping table associated with APN-profile takes preference over SGW-Service qci-qos-mapping table.
- For CORE/uplink side qci-qos mapping table associated with APN config takes preference over PGW-Service qci-qos-mapping table.
- In case SGW-service qci-qos mapping table is not configured, then PGW-service qci-qos-mapping table is applied on both ACCESS/CORE side.
- In case PGW-service qci-qos mapping table is not configured, then SGW-service qci-qos mapping table is applied on ACCESS side and no DSCP markings applied on CORE side.
- DSCP markings are updated on UP in create/update FAR sent as a part of SX Establishment/Modification request from CP to UP.
- Update the TLM, IPM & TLMO in case of HO from Pure-P to Collapse and vice-versa in Sx Modification request as a part of Update FAR IE.
- Update the layer2 markings in case of HO from Pure-P to Collapse and vice-versa in Sx Modification request as a part of Update FAR IE.

Following table depicts the various possible config combinations and outcome for DSCP markings to be applied on ACCESS and CORE side for COLLAPSE call:

S. No.	Feature Enable/Disable	PGW Service QOS-QCI table configured(Q1)	SGW Service QOS-QCI table configured(Q2)	APN QOS-QCI table configured(Q3)	APN-Profile QOS-QCI table configured(Q4)	ACCESS/Downlink DSCP Markings for Collapse Call	CORE/Uplink DSCP Markings for Collapse Call
1	ENABLE	YES	YES	YES	YES	Q4 (APN-Profile)	Q3(APN)
2	ENABLE	YES	YES	YES	NO	Q2 (SGW-Service)	Q3(APN)
3	ENABLE	YES	YES	NO	YES	Q4 (APN-Profile)	Q1(PGW-service)
4	ENABLE	YES	YES	NO	NO	Q2 (SGW-Service)	Q1(PGW-service)

S. No.	Feature Enable/Disable	PGW Service QoS-QCI table configured(Q1)	SGW Service QoS-QCI table configured(Q2)	APN QoS-QCI table configured(Q3)	APN-Profile QoS-QCI table configured(Q4)	ACCESS/Downlink DSCP Markings for Collapse Call	CORE/Uplink DSCP Markings for Collapse Call
5	ENABLE	YES	NO	YES	YES	Q4 (APN-Profile)	Q3(APN)
6	ENABLE	YES	NO	YES	NO	Q3(APN)	Q3(APN)
7	ENABLE	YES	NO	NO	YES	Q4 (APN-Profile)	Q1(PGW-service)
8	ENABLE	YES	NO	NO	NO	Q1(PGW-service)	Q1(PGW-service)
9	ENABLE	NO	YES	YES	YES	Q4 (APN-Profile)	Q3(APN)
10	ENABLE	NO	YES	YES	NO	Q2 (SGW-Service)	Q3(APN)
11	ENABLE	NO	YES	NO	YES	Q4 (APN-Profile)	N/A (NO DSCP)
12	ENABLE	NO	YES	NO	NO	Q2 (SGW-Service)	N/A (NO DSCP)
13	ENABLE	NO	NO	YES	YES	Q4 (APN-Profile)	Q3(APN)
14	ENABLE	NO	NO	YES	NO	Q3(APN)	Q3(APN)
15	ENABLE	NO	NO	NO	YES	Q4 (APN-Profile)	N/A (NO DSCP)
16	ENABLE	NO	NO	NO	NO	N/A (NO DSCP)	N/A (NO DSCP)
17	DISABLE	YES	YES	YES	YES	Q3(APN)	Q3(APN)
18	DISABLE	YES	YES	YES	NO	Q3(APN)	Q3(APN)
19	DISABLE	YES	YES	NO	YES	Q1(PGW-service)	Q1(PGW-service)
20	DISABLE	YES	YES	NO	NO	Q1(PGW-service)	Q1(PGW-service)
21	DISABLE	YES	NO	YES	YES	Q3(APN)	Q3(APN)
22	DISABLE	YES	NO	YES	NO	Q3(APN)	Q3(APN)
23	DISABLE	YES	NO	NO	YES	Q1(PGW-service)	Q1(PGW-service)
24	DISABLE	YES	NO	NO	NO	Q1(PGW-service)	Q1(PGW-service)
25	DISABLE	NO	YES	YES	YES	Q3(APN)	Q3(APN)
26	DISABLE	NO	YES	YES	NO	Q3(APN)	Q3(APN)
27	DISABLE	NO	YES	NO	YES	N/A (NO DSCP)	N/A (NO DSCP)
28	DISABLE	NO	YES	NO	NO	N/A (NO DSCP)	N/A (NO DSCP)
29	DISABLE	NO	NO	YES	YES	Q3(APN)	Q3(APN)
30	DISABLE	NO	NO	YES	NO	Q3(APN)	Q3(APN)
31	DISABLE	NO	NO	NO	YES	N/A (NO DSCP)	N/A (NO DSCP)
32	DISABLE	NO	NO	NO	NO	N/A (NO DSCP)	N/A (NO DSCP)

Statistics

Use the following User Plane CLI to show the number of TOS marked packets for U/L and D/L.

show sub user-plane-only full all



CHAPTER 21

Dynamic and ADC Charging Rule Names

- [Revision History, on page 181](#)
- [Feature Description, on page 181](#)

Revision History



Note Revision history details are not provided for features introduced before release 21.24.

Revision Details	Release
First introduced	Pre 21.24

Feature Description

With this feature, the Operators can support Mobility Services Platform (MSP) functional use cases.

This feature covers the following requirements:

- Support of 64 rules is for:
 - Dynamic rules on default bearer with flow descriptions.
 - ADC rules with and without flow descriptions.
- Up to 174 PDRs, and its corresponding FARs, URRs and QERs, are supported for static rules, predefined rules, dynamic rules, and ADC rules.
 - Up to 206 URRs are supported for static rules, predefined rules, dynamic rules, and ADC rules.
- All rules information is communicated to User Plane using Create PDR, Create URR, Create FAR and Create QER.
- All Sx messages supports the required number of PDR, URR, FAR, QER and Usage report, Query URR.
- Monitor protocol displays all Sx messages.

- Monitor subscriber displays all Sx messages.



CHAPTER 22

Dynamic APN and IP Pool Support

- [Revision History, on page 183](#)
- [Feature Description, on page 183](#)
- [How It Works, on page 183](#)
- [Configuring Dynamic APN and IP Pool Support, on page 185](#)

Revision History



Note Revision history details are not provided for features introduced before release 21.24.

Revision Details	Release
First introduced	Pre 21.24

Feature Description

The Dynamic APN and IP Pool Support feature enables the following functionality:

- Addition of an IP pool in an APN that previously had no IP pool configurations.
- Modification or removal of an existing IP pool configuration in an APN and adding a different one.
- Deletion or removal of existing IP pool configurations in an APN.

This feature supports dynamic configuration changes of the APN IP pools and groups and allocates the chunk to the User Plane (UP) without Sx reassociation.

How It Works

This section provides a brief of how the Dynamic APN and IP Pool Support feature works.

The Demux conveys the dynamically added APN and IP pool configuration to the VPN Manager. This information ensures the allocation of resources without Sx link breakage. The Control Plane (CP) then pushes the configuration to the User Plane via the Sx-Association Update message.

Dynamically Triggering APN IP Pool Addition Request

You can add APN and IP pools associated to new or existing APNs dynamically. During runtime, the new APNs and IP pools are added to the configuration. The configuration update occurs without causing any break in the Sx association between CP and UP.

The Dynamic APN and IP Pool Support feature also supports the following functionality:

- Addition of new IP pools or UP groups to existing APNs
- Addition of new APN to existing UP groups

This feature supports the following scenarios:

Operation on APN	Operation on IP Pool/Group	Operation on UP Group	Impact on existing calls
Addition of new APN	New pool or new group	New UP group (not registered)	No impact
Addition of new APN	New pool or new group	Existing UP group (already few UP registered)	No impact
Addition of new APN	Defaults pool	Existing UP group (already few UP registered)	No impact
Existing APN	Remove existing IP pool or group and add new IP pool or group	Existing UP group (already few UP registered)	No further allocation from the removed IP pool. No impact on calls.
Existing APN	Remove existing IP pool or group and add new IP pool or group	Default UP group	No further allocation from the removed IP pool. No impact on calls.
Existing APN	Remove existing IP pool or group from APN	Default UP group	No further allocation from the removed IP pool. No impact on calls.
Removing APN	Pass the new set of IP pools or groups to VPNMgr-C for each impacted UP	Existing UP group (already few UP registered)	All existing calls associated to that APN aren't affected but no new calls are connected.

Figure 6: Dynamic Addition of APN and IP Pools

After the newly added UP registration is successful, the VPN manager pushes the IP chunk information to the UP from the pool.

- The CP Sx-demux receives the trigger from the CLI for adding, modifying, or deleting a new APN or IP pools.
- The Sx-C demux on the CP determines the list of impacted UPs. It passes on the information for each impacted UP to the VPN manager at the CP using the Modify APN IP Pool Request.
- The VPN manager allocates the IP chunks and replies with a success or failure to the Sx-C demux.
- The new APN or IP pool is applied to the existing configuration. Use the “show config” CLI command to view the configuration.
- The addition of a new IP pool name or UP group to an existing APN does not affect the existing calls on that APN.
- Any IP pool (either IPv4 or IPv6) can be added to APN dynamically and can be modified (deleted and a new IP pool is added) in the same run. This change does not impact the existing calls in any way. The changed configuration applies only after the new calls to the APN are made.
- If any calls are running on a specific APN, any attempt to deleting that APN throws an error.
- Only APN that have no calls running can be deleted. The IP pools chunks associated to this APN are available for use to other APNs.

Passing of Allocated Chunks Information to the UP

- On receiving an Sx Association Update Request or Response message, the proprietary or custom IE pushes the IP chunk information to the UP.
- The S1-U demux on the UP passes on this information to the VPN manager on the UP
- The VPN manager receives the BGP routes, which it announces on a per chunk basis.

Limitations

The Dynamic APN and IP Pool Support feature has the following limitations:

- Any operation on IP pools and UP group associated to existing APN is not supported in this release.
- Multiple UPs won't be able to access the same IP pool as a part of this release.
- If a new UP_GROUP is added against an APN without configuring any new IP pool, then the calls start landing on the new UP_GROUP rather than the default one. This causes the calls to get aborted.

Configuring Dynamic APN and IP Pool Support

This section describes how to configure the Dynamic APN and IP Pool Support feature.

Follow this sequence of commands to add a new APN (addition of the IP pool is optional).

- Create a new IP pool. For more information, see the **ip address** *ip_pool_name* CLI command in the *Command Reference Guide*.

To add an IP pool to an IP pool group, use the **ip pool** *ip_pool_name* **static group-name** *ip_pool_group_name* CLI command. For more information, see the *Command Reference Guide*.

- Add a new APN and associate the new IP pool to this APN. For more information, see the **apn** *apn_name* CLI command in the *Command Reference Guide*.

To add an IP Pool group to the APN, use the **ip address pool name** *ip_pool_group_name* CLI command. For more information, see the *Command Reference Guide*.

- Push the configuration to the UP.
- Update the IP pool information to the VPN manager.
- Run an attach call.

Updating the APN Configuration

Use the following command in Exec mode to update the VPN manager with the APN configuration changes.

To update all the configured APNs to the VPN manager:

```
update ip-pool apn all
end
```

To update a specific APN configuration to the VPN manager:

```
update ip-pool apn name apn_name
end
```

NOTES:

- This CLI command triggers the SX_ASSOCIATION_UPDATE towards the UP and transfers all the allocated IP pool chunks for the newly added IP pools.

Example

The following CLI command updates a specific APN configuration to the VPN manager:

```
update ip-pool apn name cisco.com
```

Verifying Dynamic APN and IP Pool Support

Use the following command to verify the Dynamic APN and IP Pool Support feature.

```
show config apn intershat
```

The following is a sample output of the show command:

```
config
context ingress
  apn intershat
    pdp-type ipv4 ipv6
    bearer-control-mode mixed
    selection-mode subscribed sent-by-ms chosen-by-sgsn
    ims-auth-service ims-ggsn-auth
    ip access-group acl4-1 in
    ip access-group acl4-1 out
    ip context-name egress
    ip address pool name ipv4-test
    ipv6 access-group acl6-1 in
    ipv6 access-group acl6-1 out
    active-charging rulebase prepaid
```



```
    exit
  #exit
end
```



CHAPTER 23

ECS Regular Expression Support

- [Feature Summary and Revision History, on page 189](#)
- [Feature Description, on page 189](#)
- [How It Works, on page 190](#)
- [Configuring Regex Rule, on page 191](#)
- [Monitoring and Troubleshooting, on page 192](#)

Feature Summary and Revision History



Note Revision history details are not provided for features introduced before release 21.24.

Revision Details	Release
First introduced	Pre 21.24

Feature Description

This feature provides the Enhanced Charging Support (ECS) for regular expression (regex) rule matching. The intent of the feature is to implement the regex engine in User Plane to enable RCM and PFD-based regex configuration/matching. The User Plane supports the following protocols as a part of regex engine rebuild and rule matching.

- HTTP
 - URL
 - URI
 - HOST
- WWW
 - URL
 - URI

- RTSP
 - URL
 - URI

How It Works

The following table lists the special characters that you can use in regex rule expressions.

Convention	Description
*	Zero or more characters.
+	Zero or more repeated instances of the token preceding the +.
?	Zero or one character.
\character	Escaped character.
\?	Match on a question mark (\<ctrl-v>?)
\+	Match on a plus sign
*	Match on an asterisk
\a	Alert (ASCII 7)
\b	Backspace (ASCII 8)
\f	Form-feed (ASCII 12)
\n	New line (ASCII 10)
\r	Carriage return (ASCII 13)
\t	Tab (ASCII 9)
\v	Vertical tab (ASCII 11)
\0	Null (ASCII 0)
\\	Back slash
Bracketed range [0-9]	Matching any single character from the range.
A leading ^ in a range	No match in the range. All other characters represent themselves.
.\x##	Any ASCII character as specified in two-digit hex notation. For example, \x5A yields a 'Z'.

Following are the two ways to configure the regex rule:

- Regex rule configuration via RCM:

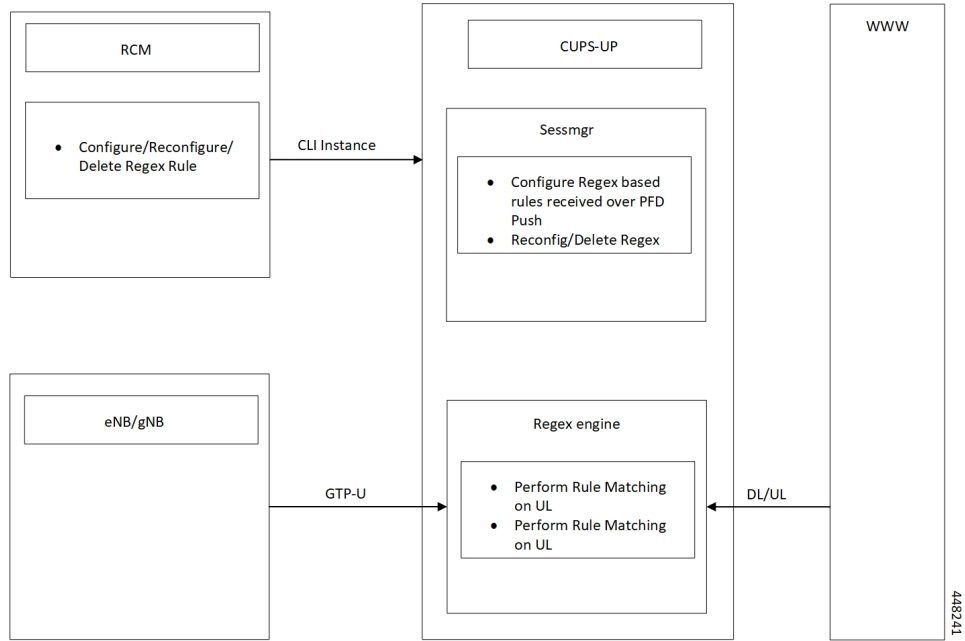

• Regex rule configuration via PFD Push:

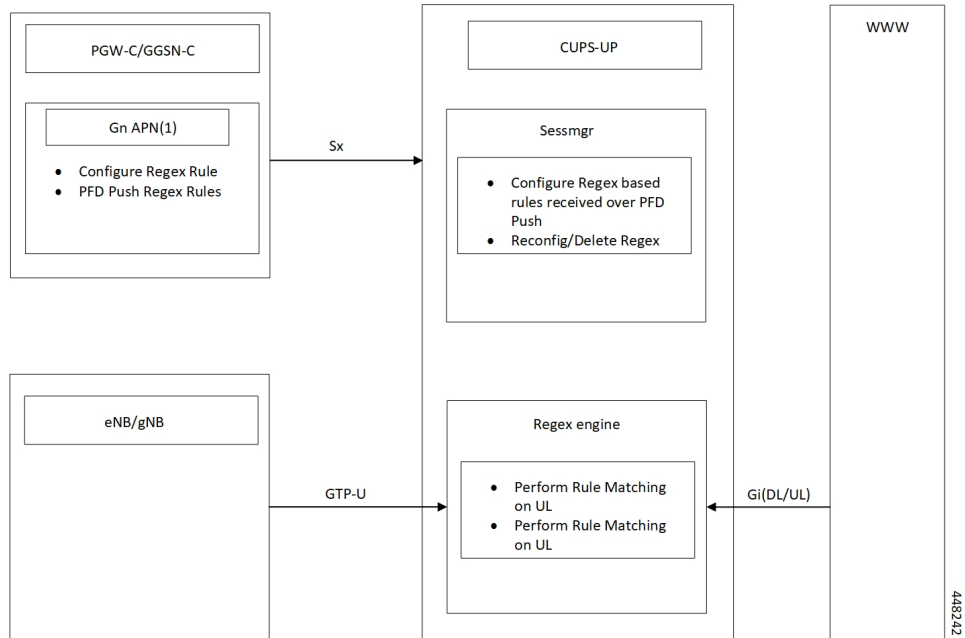

Configuring Regex Rule

Following are the two ways to configure the Regex Rule.

Configuring Regex Rule via RCM

Configure the regex rule via RCM through User Plane CLI instance or directly on User Plane via CLI.

```
configure
    require rcm-configmgr
end
```

Configuring Regex Rule via PFD Push

Configure the regex rule on Control Plane through the User Plane via PFD push.

```
configure
    push config-to-up all
end
```

Sample Configuration

Following are the sample configuration for configuring the Regex Rule.

```
configure
    active-charging service <service_name>
        ruledef <ruledef_name>
            http url regex <regex_url>
            rtsp uri regex <regex_uri>
            www url regex <regex_url>
        end
    end
```



Note

- For RCM - Execute the regex rule configuration through the User Plane CLI instance.
- For PFD - Execute the regex rule configuration through the Control Plane and execute the PFD push.

Monitoring and Troubleshooting

This section provides information on CLI commands that are available for monitoring and troubleshooting for Regex support in User Plane.

Show Commands and Outputs

This section provides information about show CLI commands that are available in support of Regex support in User Plane.

- **show user-plane-service regex status:** Use this command to display the engine status for SessMgr instance.
- **show user-plane-service regex statistics memory:** Use this command to display the memory stats for SessMgr instance.

- **show user-plane-service regex statistics memory summary:** Use this command to display the combined memory summary for the SessMgr.
- **show user-plane-service regex statistics ruledef:** Use this command to display the regex ruledef stats for the SessMgr.
- **show user-plane-service regex statistics ruledef summary:**
Use this command to display the combined regex ruledef stats summary for the SessMgr.



CHAPTER 24

End Marker Packets

- [Revision History](#), on page 195
- [Feature Description](#), on page 195

Revision History



Note Revision history details are not provided for features introduced before release 21.24.

Revision Details	Release
First introduced	Pre 21.24

Feature Description

In case of eNodeB relocation during handover procedure without SGW-U change, the SGW-C indicates the SGW-U to switch the S1 path(s) by sending a Sx session modification request message with the new F-TEID-u of eNodeB. In addition, provides an indication to the SGW-U to send the End Marker Packet(s) on the old path. On receiving this indication, the SGW-U constructs End Marker Packet(s) and sends it for each S1 GTP-U tunnel toward the source eNodeB, after sending the last PDU on the old path.

End Marker packet is sent per GTP-U TEID during above scenarios.

The Control Plane requests the User Plane to construct and send End Marker packets by sending a Session Modification Request including FAR(s) with the new downstream F-TEID, and with the SNDEM (Send End Marker Packets) flag set.

Information Element	P	Condition/Comment
PFCPSMReq-Flags	C	SNDEM (Send End Marker Packets): This IE shall be present if the CP function modifies the F-TEID of the downstream node in the Outer Header Creation IE and the CP function requests the UP function to construct and send GTP-U End Marker messages toward the old F-TEID of the downstream node.

Limitation

Handoffs in P-GW is not supported for sending End Marker. This behavior is similar to non-CUPS.



CHAPTER 25

Enterprise Onboarding in CUPS

- [Feature Revision History](#), on page 197
- [Feature Description](#), on page 197
- [How it Works](#), on page 199
- [Enterprise Onboarding in CUPS OAM Support](#), on page 216

Feature Revision History



Note Revision history details are not provided for features introduced before release 21.24.

Revision Details	Release
First introduced	Pre 21.24

Feature Description

In CUPS architecture, User Planes (SAEGW-U) are grouped into a logical concept called User Plane Group (UP Group) and controlled by a Control Plane (CP) node. An APN is associated with a UP Group, and the UP for IP pool is selected based on least-used User Plane.

During configuration of new APNs and IP pools, the operator must decide on a UP Group to be used. The information required to decide the UP Group is not exposed by the system and the process is tedious and error prone. Also, the number of contexts, APNs, VRFs, and IP pools are reduced both on CP and UP in CUPS architecture as compared with ASR 5500. This also limits the addition of new APNs and IP Pools to the right context and UP Group.

The Intelligent Onboarding (IOB) tool automates the procedure of choosing the right UP Group and SGi context for the new APN to be added. The tool gathers current resources that are configured (number of UP Groups, UPs per group, existing contexts, APNs, and IP pools) in the CUPS system. It then determines if the system can absorb the new configuration and determines the UP Group that can support without breaching the system limits. In line with this, the new configuration is applied by the tool.

Operational Use Case

The Enterprise requires an operator to add, modify, and/or delete a user with information based on APN and IP pools. The tool generates and applies the required configuration to add, modify, or delete an APN in the CUPS environment.

The following operations can be performed:

- Enterprise Addition: A new APN is added with required number of IPv4/IPv6 pools.
- Enterprise Modification: IP pools can be added/deleted for an existing APN.
- Enterprise Deletion: An APN will be deleted.

In 21.20.13 and later releases, the IOB tool also supports the onboarding of one or more virtual APNs in one operation. As part of this operation, one or more existing APNs can be modified to reference these new virtual APNs. Similarly, the tool also supports deleting the set of virtual APNs onboarded together and simultaneously removing existing references to those APNs from other APNs.

Architecture

On ASR 5500, Enterprise addition consists of adding a new APN. For CUPS, along with the APN configuration, we must include the correct UP Group and SGi context configuration.

The IOB tool takes inputs from the Provisioning tool, chooses the best suited UP Group and SGi context for the APN, and configures the CP and UP. The IOB tool also allows modification of the APN configuration (adding/deleting the IP pools) and Deletion of an APN.

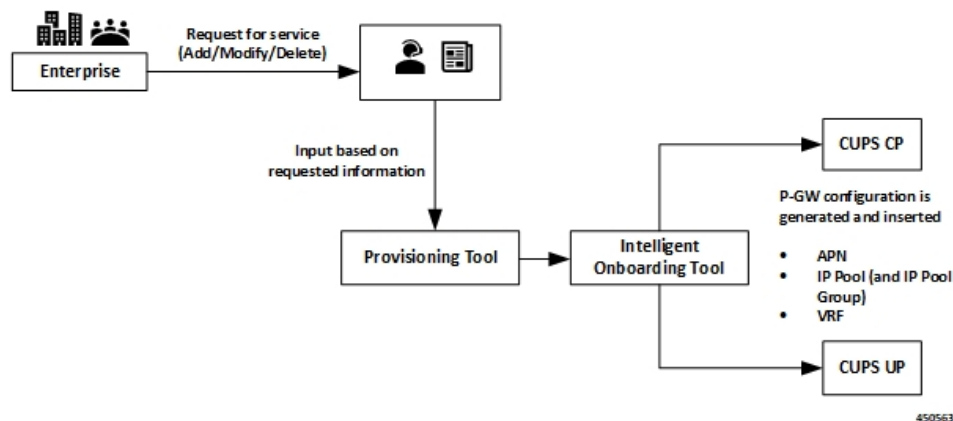

If onboarding multiple APNs, the APN configuration section must list:

- The configuration for all onboarding APNs and
- APNs referring to them (in case of virtual APNs)

In the preceding scenario, all the APNs get onboarded onto the same UP group and SGi context.

Installation

The IOB tool is shipped as Linux executable. All dependencies, like Pexpect and connection management library, are packaged into the standalone .exe file.

The tool is shipped with StarOS images and signed with the same keys that are used for StarOS VPC-SI image.

The executable tool requires the following environment:

- RedHat Enterprise Linux 7.6 (or CentOS equivalent) 64-bit installation
- OpenSSL version 1.0.2.k-fips
- The following shared libraries are installed under /lib64 (these are typically present in a standard RHEL or CentOS installation):
 - libdl.so.2
 - libz.so.1
 - libc.so.6
 - ld-linux-x86-64.so.2
- Read, write, execute permissions for /tmp directory. While executing, the tool creates a temporary directory under /tmp, extracts sections of the executable to this temporary directory and executes the sections.
- Sufficient disk space for the tool and the log files (current usage is approximately 10 MB)
- IP connectivity to CPs and UPs on which onboarding is to be done. Password-based SSH is used for connections.

How it Works

The IOB tool is a standalone application that leverages StarOS CLIs to collect the system level resources, read the configurations, check the errors, SRP information, and so on. The input parameters to the IOB tool include addressing and login credentials for CPs and UPs, details of the operation (add/modify/delete), and the specific configuration to be applied. Since the contexts to apply the configuration to may not be known beforehand, the input configuration specifies a dummy context as a placeholder. The IOB tool substitutes that dummy context with the specific context that is chosen prior to applying the configuration.

Also, as part of Enterprise Onboarding solution, a new CLI command is introduced, and an existing CLI command is modified. For details, see *Enterprise Onboarding in CUPS OA&M Support* section.

The IOB tool goes through the following steps:

- **Pre-processing:** This is performed to ensure that the system is in stable state to proceed with the onboarding operation. On successful validation, the IOB tool collects the current resource usage information from the system.
- **Context and UP Group Selection:** The IOB tool applies the onboarding algorithm to select a context and UP Group to onboard the APNs.
- **Configuration:** Based on the operation to be performed, an algorithm is applied using the data collected in the Pre-processing step. The configuration is then applied on CP and UP. For any failure scenario, the IOB tool attempts to roll back to the previous configuration.

- **Post-processing:** Post configuration checks are performed to validate the system for any errors. For any failure scenario, the IOB tool attempts to roll back to the previous configuration.
- **Logging:** The entire operation is logged. The logging mechanism captures the output of the operation, history of the operation, Warnings/Error messages, and any other information that helps in debugging.

Pre-Processing

Pre-processing step helps in understanding the status of the CUPS system where the onboarding operation is being performed. In the pre-processing stage, following checks are performed irrespective of the operation:

- Verify if all CP and UP management IPs are reachable:
 - Ping Active/Standby management IPs of all the CPs.
 - Ping Active/Standby management IPs of all the UPs.
- Collect the resources information (APN, IP Pools, VRF, and Context) based on the output of:
 - **show ip user-plane verbose**
 - **show cups-resources session summary**
- **Add Operation:**
 - On Control Plane node, following checks are performed:
 - Verifies that the VRF, APN, and IP pool to be onboarded is not configured in the system. If onboarding one or more virtual APNs, then the APNs that refer to these virtual APNs must be already present on the system. The tool uses the presence of the following configuration in the APN to distinguish these APNs.

```
virtual-apn gcdr apn-name-to-be-included Gn
```

So, given an input configuration with one or more APNs, then any APN that is already present in the system must include the preceding configuration. Otherwise, the tool assumes that the APN isn't present and hence fails the preaudit step.
 - Verifies that there is no configuration difference between Active/Standby CPs using **show srp info**.
 - After context and UP Group selection, on User Plane node, the following pre-processing checks are performed on all the UPs of the selected UP Group:
 - Verifies that the VRF to be onboarded doesn't exist in the system. If it exists, then the pre-processing fails and onboarding is aborted.
 - Verifies that there is no configuration difference between Active/Standby UPs using **show srp info**.
 - Verifies if SGi context is mapped in the UP Groups.
- **Modify Operation:**
 - On Control Plane node, following checks are performed:
 - Verifies that the VRF to be modified exists in the system.

- Verifies that the APN to be modified exists in the system.
 - Verifies that the IP pools, deleted as part of modify operation, exists in the system. Any IP pool that is added as part of modify operation, doesn't exist in the system.
 - Verifies that there is no configuration difference between Active/Standby CPs using **show srp info**.
- **Delete Operation:**
 - On Control Plane node, following checks are performed:
 - Verifies that the VRF to be deleted exists in the system.
 - Verifies that the APN(s) to be deleted exists in the system.
 - Verifies that there is no configuration difference between Active/Standby CPs using **show srp info**.
 - On User Plane node, following checks are performed:
 - Verifies that the VRF to be deleted exists in the system.
 - Verifies that there is no configuration difference between Active/Standby UPs using **show srp info**.

CP and UP Configuration

On successful pre-processing, the tool performs the Add/Modify/Delete operation as per the input and applies the configuration on CP and UP. For ICSR setups, the configuration is applied on both Active and Standby CP and UPs.

- Add operation: The algorithm chooses the right SGi context and UP group for the APN to be added.
 - On Control Plane node, following steps are performed:
 - The chosen SGi context and the UP Group are added to the APN configuration, which goes as input to the tool. In case of onboarding virtual APNs, only the onboard virtual APNs get updated with UP Group and IP context. The APNs that refer to them (which is already present in the system) just gets updated with any **virtual-apn preference ..** configuration that is present in the input file.
 - The updated configuration is then applied to the CP node.
 - On User Plane node:
 - The IOB tool replaces the dummy SGi context with chosen context, and applies the resulting configuration to all the UPs in the chosen UP Group.
 - Applies VRF configurations to all the UPs in the UP Group.
 - For any failure scenario, the IOB tool attempts to roll back to the previous configuration.
- Modify Operation: Configuration is modified to add or delete the IP pools.

- On Control Plane node:
 - For the given APN configuration, IP pool configuration is modified to add/delete the IP pools. If any IP pools are deleted, then prior to deletion, the tool:

- Busyouts the pool.

- Clears existing subscribers for that pool per pace-out interval. The pace-out interval is calculated based on the size of the pool.

For IPv6 pools, the formula is:

$$\text{Pace-out interval} = (2^{(64 - \text{pool size})} * 2 - 2) / 500$$

So, a /48 pool will get a pace-out interval of $(2^{(64 - 48)} * 2 - 2) / 500 = (2^{16} * 2 - 2) / 500 = 131070 / 500 = 262$ seconds

For IPv4 pools, the formula is:

$$\text{Pace-out interval} = (2^{(32 - \text{pool size})} * 2 - 2) / 500$$

So, a /21 pool will get a pace-out interval of $(2^{(32 - 21)} * 2 - 2) / 500 = (2^{11} * 2 - 2) / 500 = 4094 / 500 = 8$ seconds

- For any failure scenario, the IOB tool attempts to roll back to the previous configuration.

- Delete Operation: Deletes the APN.

- On Control Plane node:

- IP pools and VRFs, associated with the APN, are deleted.

Prior to deleting any APN, the IOB tool verifies if any user is attached to the given APN. If any user exists, it exits from the tool and displays an error message "Please clear the subscribers then run the DELETE_ENTERPRISE else it will delete the APN".

- APN configuration is deleted.

- Deleting the virtual APNs removes only the virtual APNs and references to the virtual APNs. The APNs that refer to them are expected to remain in the system. Otherwise, post audit will fail.

- On User Plane node, VRF configurations are deleted.

The IOB tool doesn't rollback to the previous configuration on a failure. It, however, tries to delete as much of the relevant configuration as possible to minimize the amount of manual clean-up required.

Post-Processing

After the configurations are pushed to CP and UP, checks are performed to validate configuration changes.

- Add Operation:

- On Control Plane node, following checks are performed:

- Verifies configured VRF with **show ip vrf** *vrf_name*: To verify if the VRF configuration is applied in the CUPS system.
 - Verifies that the chosen context is shown with **show configuration apn** *apn_name*: To verify if the context has been associated with the APN that is added. This verification takes place for each APN that is onboard. If there are virtual APNs onboard, then this verification takes place only for each virtual APN.
 - Verifies that the chosen UP Group is shown under **show configuration apn** *apn_name*: To verify if the UP Group has been associated with the APN that is added.
 - If there are virtual APNs onboard, then the tool verifies that all the references to the virtual APNs from other APNs as per the input configuration (**virtual-apn preference** *<preference>* **apn** *<virtual apn>* and so on) are present and correct.
 - Saves configuration using **save configuration** *file_path / file_name*: After successful addition of new enterprise, checks if the respective configuration files are stored in the given path as mentioned in "CUPSinfo.txt" file.
 - Synchronize configuration on CPs with **filesystem synchronize**: After successful addition of new enterprise, verifies the file synchronization.
 - Verifies that there is no configuration difference between CPs using **show srp info**: SRP validation in ICSR setup: After successful addition of new enterprise, the IOB tool checks for SRP validation with "Primary" and "secondary" status, "Last Peer Configuration Error", "Connection State", along with "Number of Sessmgrs".
- On User Plane node, following checks are performed:
 - Verifies configured VRF with **show ip vrf** *vrf_name*: To verify the VRF configuration applied in the CUPS system.
 - Verifies Route Distinguisher using **show ip vrf** *vrf_name*: To verify the Route Distinguisher configuration applied in the CUPS system.
 - Save configuration using **save configuration** *file_path / file_name*.
 - Invoking SRP validation using **srp validate-configuration**: Verifies that there is no configuration difference between UPs using **show srp info**: SRP validation in ICSR setup.
 - For any failure scenario, the IOB tool attempts to roll back to the previous configuration.
- Modify Operation:
 - On Control Plane node, following checks are performed:
 - Verifies that the modified changes are applied to the CUPS system.
 - Verifies that the changes to IP pool are reflected in the system
 - Saves configuration using **save configuration** *file_path / file_name*.
 - Invoking SRP validation using **srp validate-configuration**: Verifies that there is no configuration difference between UPs using **show srp info**: SRP validation in ICSR setup
 - For any failure scenario, the IOB tool attempts to roll back to the previous configuration.

- Delete Operation:
 - On Control Plane node, following checks are performed:
 - This verification takes place for each APN after the delete operation. The delete operation for the virtual APN removes only the references to the virtual APN and retains the APNs that refer to them. Removal of the latter APNs causes the post processing to fail.
 - Verifies if the VRF configuration is deleted from the CUPS system.
 - Saves configuration using **save configuration file_path / file_name**.
 - Invoking SRP validation using **srp validate-configuration**: Verifies that there is no configuration difference between UPs using **show srp info**: SRP validation in ICSR setup
 - On User Plane node, following checks are performed:
 - Verifies if the VRF configuration is deleted from the CUPS system.
 - Saves configuration using **save configuration file_path / file_name**.
 - Invoking SRP validation using **srp validate-configuration**: Verifies that there is no configuration difference between UPs using **show srp info**: SRP validation in ICSR setup.

Add Operation

The Add operation configures a new APN for the enterprise customer. The tool also supports onboarding multiple APNs in one operation, provided they share the same SGi context and VRF configuration. In this case, the onboarding APNs may or may not share the IP pool information (supports both the conditions). All the onboarding APNs map to the same SGi context and UP group in the preceding scenario. The algorithm chooses the right SGi context and UP Group, and maps them to the APN by taking the system parameters into consideration.

Algorithm Logic:

- Check for System Limits (done against CP limits mentioned in [System Limits, on page 214](#)). In case of onboarding virtual APNs, the tool only considers the virtual APNs as new APNs for APN limit calculation. The APNs referring to the virtual APNs are already present in the system and are hence already included in the current count of APNs in the system.
- Rank UP Groups based on number of APNs configured with low numbers on top.
- Sort the SGi contexts based on the number of VRFs configured in ascending order.
- Exclude VIP UP Groups and Contexts from the list.
- Pick a UP Group from top of the list (least-used):
 - Get a Context that is mapped to UP Group (if no Contexts are mapped, pick from the sorted list).
 - Check the number of VRFs, IPv4, IPv6 pools, and total pool size.
 - Choose the Context if checks fall within thresholds; else, repeat for next Context.
 - Pick suitable Context within limits; if none found, exit algorithm.
 - For this UP Group, iterate through UPs and check total IP pool limits.

- If successful, choose the UP Group and Context.
- Iterate through all UP Groups.
- At each step, while checking against the thresholds, print error messages.
- Prepare the configuration with chosen Context and UP Group and apply.

Modify Operation

Modify operation allows the onboarded Enterprise customer to increase/decrease the subscribers by Adding more IP pools or deleting the existing IP pools.

Delete Operation

Delete operation removes a previously onboarded Enterprise. During this operation, the IOB tool cleans up the IP pools, VRFs, and APNs that are used for the Enterprise.

To delete an Enterprise, the following procedure must be followed as there may be active subscribers on the system:

- Busyout the IP Pools: This is performed to block the new subscribers. Invoke IOB tool and perform the Busyout operation using the MODIFY operation.
- Clear Subscribers: The Provisioning tool clears the active subscribers.
- Delete the Enterprise: Invoke the IOB tool and perform the enterprise removal using the DELETE operation.

Password Encryption

The IOB tool expects passwords in the "CUPSInfo.txt" input file to be RSA encrypted and converted to base64 format. Encryption is done using OpenSSL (currently, version 1.0.2.k is supported) commands and RSA public key. The IOB tool must be provided the path to the corresponding RSA private key so that it can decrypt the passwords. The decrypted passwords are stored only in the IOB tool's RAM. The detailed steps for encryption and decryption are described below:

1. Verify that the OpenSSL with the correct version is installed on the target machine:
 - "openssl version" should indicate that the version is 1.0.2.k-fips.
2. Generate RSA private and public key pair:
 - a. RSA private key:

```
openssl genpkey -algorithm RSA -out private_key.pem -pkeyopt rsa_keygen_bits:4096
```

Where:

- "private_key.pem" represents the generated private key file in PEM format. This is used for decryption and has to be stored securely.

- 4096 is the key length in bits. Either 2048 or 4096 can be used. Multiple passwords may need to be encrypted and so, 4096 is recommended. Generally, the larger the key size, the larger the size of data it can encrypt. However, it also takes longer to encrypt/decrypt.

b. RSA public key:

```
openssl rsa -pubout -in private_key.pem -out public_key.pem
```

Where:

- "private_key.pem" is the private key generated in Step (a).
- "public_key.pem" is the file that contains the corresponding public key.

3. For each password that needs to be encrypted, do the following:

- a.** Type the password in plaintext in a text file using an editor. Don't hit enter at the end of the line. It should have just the password in a single line. In this example, the file is named as "pp1".

b. Execute:

```
openssl pkeyutl -encrypt -inkey public_key.pem -pubin -in pp1 -out encrypted_pp1
```

Where:

- "public_key.pem" is the public key generated in Step 2b.
- "pp1" is the file containing the single password in plaintext.
- "encrypted_pp1" contains the password in encrypted form.

Delete "pp1" created in *Step 3a* to avoid accidental exposure.

- c.** "encrypted_pp1" contains the key in raw binary form. Convert it to base64 as follows:

```
base64 encrypted_pp1
```

- d.** The above command (Step 3c) will output the base64 encoded encrypted password to the terminal. Copy and paste this into the "CUPSinfo.txt" file that contains the credentials supplied to the IOB tool. While copying, make sure to remove any line breaks or spaces. The entire password should be a single line.
- e.** "encrypted_pp1" can be deleted at this point.



Note *Step 3* must be performed for each password, one at a time, using the same public key/private key pair for all the passwords.

After "CUPSinfo.txt" file is updated with all the encrypted base64 passwords, the IOB tool is ready to be run. When running the script, specify an additional parameter: **-k** *absolute path to private_key.pem created in Step 2a*>.

Onboarding Application – Usage and Input Parameters

The application is compiled to create a standalone .exe. The application can be run on a RedHat Enterprise Linux machine.

The Onboarding Application can be run with below syntax:

```
./intelligent_onboarding -o <OP_Type_Parameter_File> -i <CUPS_Info_File> -k
<Path_to_Pvt_Key_file> [ -l <Path_to_store_logfiles> ] [ -p ] [ --context_selection_from_cp
] [ -v ]
```

Options:

- **-o:** [Mandatory] Provide the input parameter file specific to the operation being invoked.
After successful onboarding, the IOB tool deletes the file.
- **-i:** [Mandatory] This option is used for "CUPSinfo.txt" file which has the details of CUPS system.
- **-k:** [Mandatory] Absolute path to the private key file. The tool uses this to decrypt the previously encrypted passwords. This private key file must correspond to the public key that is used to encrypt the passwords.
- **-p:** [Optional] When included, few pre-audit and post-audit checks are bypassed to reduce the time taken for Add/Modify/Delete operation.

- **-l:** [Optional] Provide absolute path to store the logs.

When this keyword is not specified, the log files are created in the directory from which the IOB tool is invoked.

- **--context_selection_from_cp:** [Optional] When specified, the tool bases its context selection solely on the list of contexts available on the CP. The tool assumes that the selected context is also available on the UPs and does not validate this. This is an optimization. The default behavior is to examine contexts configured on CP and UP and select from contexts common to both.
- **-v:** [Optional] Displays the version of the IOB executable.

If IOB tool is executed without the **-v** option, the version is displayed that is similar to:

```
#####
#
#           WELCOME TO ENTERPRISE ONBOARDING           #
#                   Version 21.20.9.private                   #
#
#####
```

NOTE: The version is displayed in the log file and terminal output as well.

CUPSinfo.txt

Onboarding application must know the system-level details to carry out the onboarding operations. The "CUPSinfo.txt" file has the IP addresses for CP and UP nodes and configurable threshold values. "Skip_UPGroup" and "Skip_Context" refers to the UP Groups and contexts that must not be considered for onboarding algorithm. For example, VIP groups and contexts that cannot be used for other enterprises. The file specifies a path where the configuration must be saved. The passwords in this file must be specified in RSA encrypted, base 64 format.

In 21.20.9 and earlier releases, the entry order of CP and UP inputs were:

```
//Control_Plane:
Host,Node,Primary_IP,Secondary-IP,Login,Password,Primary_config_path,Secondary_config_path
```

```
//User_Plane:
Host,Node,Primary_IP,Secondary-IP,Login,Password,Sx-IP-Address,Primary_config_path,Secondary_config_path
```

In 21.20.10 and later releases, the entry order of CP and UP inputs are:

```
//Control_Plane:
Host,Node,Primary_IP,Secondary-IP,Primary_config_path,Secondary_config_path,Login,Password
//User_Plane:
Host,Node,Primary_IP,Secondary-IP,Sx-IP-Address,Primary_config_path,Secondary_config_path,Login,Password
```

Sample CUPSinfo.txt File

For 21.20.9 and earlier releases:

```
//Threshold for Warning, input as percentage values

CPContext_threshold = {vrf_threshold:80, ipv4_threshold:80, ipv6_threshold:80}
CPSystem_threshold = {vrf_threshold:80, total_pool_threshold:80, apn_threshold:80}
UPContext_threshold = {vrf_threshold:80, ipv4_threshold:80, ipv6_threshold:80}
UPSystem_threshold = {vrf_threshold:80, apn_threshold:80, total_pool_threshold:80}
UPBudgeted_Sessions_threshold = {budgeted_threshold:80}

SKIP_UPGroup =
SKIP_Context =

//Control_Plane:
Host,Node,Primary_IP,Secondary-IP,Login,Password,Primary_config_path,Secondary_config_path
cups_di_cp1,Control_Plane,209.165.200.225,209.165.200.225,<login_id>,<password>,
/flash/209.165.200.225-cups-vpp-saegw-global-control-plane.cfg,
/flash/209.165.200.225-cups-vpp-saegw-global-control-plane.cfg

//User_Plane:
Host,Node,Primary_IP,Secondary-IP,Login,Password,Sx-IP-Address,Primary_config_path,Secondary_config_path
cups_di_up0,User_Plane,209.165.200.230,209.165.200.230,<login_id>,<password>,
209.165.200.238,/flash/209.165.200.230-cups-vpp-saegw-global-user-plane-.cfg,
/flash/209.165.200.230-cups-vpp-saegw-global-user-plane.cfg
cups_di_up1,User_Plane,209.165.200.235,209.165.200.235,<login_id>,<password>,
209.165.200.242,/flash/209.165.200.235-cups-vpp-saegw-global-user-plane.cfg,
/flash/209.165.200.235-cups-vpp-saegw-global-user-plane.cfg
```

In 21.20.10 and later releases:

```
//Threshold for Warning, input as percentage values

CPContext_threshold = {vrf_threshold:98, ipv4_threshold:98, ipv6_threshold:98}
CPSystem_threshold = {vrf_threshold:98, total_pool_threshold:98, apn_threshold:98}
UPContext_threshold = {vrf_threshold:98, ipv4_threshold:98, ipv6_threshold:98}
UPSystem_threshold = {vrf_threshold:98, apn_threshold:98, total_pool_threshold:98}
UPBudgeted_Sessions_threshold = {budgeted_threshold:80}

SKIP_UPGroup =
SKIP_Context =

//Control_Plane: Host,Node,Primary_IP,Secondary-IP,Primary_config_path,
Secondary_config_path,Login,Password
cups_di_cp1,Control_Plane,209.165.200.225,209.165.200.225,/flash/209.165.200.225-CP01.cfg,
/flash/209.165.200.225-CP02.cfg,<login_id>,<password>
//User_Plane: Host,Node,Primary_IP,Secondary-IP,Sx-IP-Address,Primary_config_path,
Secondary_config_path,Login,Password
cups_si_up1,User_Plane,209.165.200.235,209.165.200.235,209.165.200.242,/flash/209.165.200.235-UP01.cfg,
/flash/209.165.200.235-UP02.cfg,<login_id>,<password>
```

ADD_ENTERPRISE_INPUT_PARAMETERS.txt

This file provides the configuration information when an APN is added. It provides the IP pool information and VRF information. The context provided is dummy and the actual context is determined as part of the algorithm. The IP pools doesn't support chunks.

Sample ADD_ENTERPRISE_INPUT_PARAMETERS.txt

Following is the example configuration for onboarding a single APN.

```
OpType = "ADD_ENTERPRISE"

CP_APN_Config = '''Config
context APN
    apn starent.com
ip address pool name starent_ipv4_pool_group_01
ipv6 address prefix-pool starent_ipv6_pool_group_01
    exit
    exit
exit'''

// script will replace the dummy-SGI context with the chosen context
CP_SGI_Context = '''Config
    context dummy-SGi
ip vrf MPN00001
ip pool starent_ip_pool_v4_001 209.165.200.225 255.255.255.250 private 0 no-chunk-pool
group-name starent_ipv4_pool_group_01 vrf MPN00001
ip pool starent_ip_pool_v4_002 209.165.200.228 255.255.255.250 private 0 no-chunk-pool
group-name starent_ipv4_pool_group_01 vrf MPN00001

ipv6 pool starent_ip_pool_v6_001 prefix 2001:1:1::/48 private 0 no-chunk-pool group-name
starent_ipv6_pool_group_01 vrf MPN00001

    exit
exit'''

// UP VRF config
// script will replace the dummy-SGI context with the chosen context
UP_VRF_Config= '''config
context dummy-SGI
ip vrf MPN00001
ip maximum-routes 100
exit
router bgp 65101
ip vrf MPN00001
route-distinguisher 65101 11100001
route-target both 65101 11100001
exit
address-family ipv4 vrf MPN00001
redistribute connected
exit
address-family ipv6 vrf MPN00001
redistribute connected
exit
exit
exit
exit'''
```

Following is the example configuration for onboarding multiple virtual APNs in one ADD operation.

```
OpType = "ADD_ENTERPRISE"

CP_APN_Config = '''Config
```

```

context APN
apn virtual1
    ip address pool name apn2_ipv4_pool_group_01
    ipv6 address prefix-pool apn2_ipv6_pool_group_01
exit
apn virtual2
    ip address pool name apn2_ipv4_pool_group_02
    ipv6 address prefix-pool apn2_ipv6_pool_group_02
exit
apn virtual3
    ip address pool name apn2_ipv4_pool_group_03
    ipv6 address prefix-pool apn2_ipv6_pool_group_03
exit
apn virtual4
    ip address pool name apn2_ipv4_pool_group_04
    ipv6 address prefix-pool apn2_ipv6_pool_group_04
exit
apn virtual5
    ip address pool name apn2_ipv4_pool_group_05
    ipv6 address prefix-pool apn2_ipv6_pool_group_05
exit
apn virtual6
    ip address pool name apn2_ipv4_pool_group_06
    ipv6 address prefix-pool apn2_ipv6_pool_group_06
exit
apn virtual7
    ip address pool name apn2_ipv4_pool_group_07
    ipv6 address prefix-pool apn2_ipv6_pool_group_07
exit
apn virtual8
    ip address pool name apn2_ipv4_pool_group_08
    ipv6 address prefix-pool apn2_ipv6_pool_group_08
exit
apn virtual9
    ip address pool name apn2_ipv4_pool_group_09
    ipv6 address prefix-pool apn2_ipv6_pool_group_09
exit
apn virtual10
    ip address pool name apn2_ipv4_pool_group_10
    ipv6 address prefix-pool apn2_ipv6_pool_group_10
exit
apn real1
    virtual-apn preference 1 apn virtual2 domain virtual2
    virtual-apn preference 2 apn virtual3 domain virtual3
    virtual-apn preference 3 apn virtual4 domain virtual4
exit
apn real2
    virtual-apn preference 3 apn virtual5 domain virtual5
    virtual-apn preference 6 apn virtual6 domain virtual6
    virtual-apn preference 9 apn virtual7 domain virtual7
exit
apn real3
    virtual-apn preference 2 apn virtual6 domain virtual6
    virtual-apn preference 5 apn virtual7 domain virtual7
    virtual-apn preference 8 apn virtual8 domain virtual8
exit
apn real4
    virtual-apn preference 2 apn virtual8 domain virtual8
    virtual-apn preference 3 apn virtual9 domain virtual9
    virtual-apn preference 5 apn virtual10 domain virtual10
exit
apn real5
    virtual-apn preference 7 apn virtual10 domain virtual10
    virtual-apn preference 8 apn virtual11 domain virtual11

```



```

        virtual-apn preference 9 apn virtual2 domain virtual2
    exit
    apn real6
        virtual-apn preference 11 apn virtual10 domain virtual10
        virtual-apn preference 12 apn virtual11 domain virtual11
        virtual-apn preference 13 apn virtual2 domain virtual2
    exit
    apn real7
        virtual-apn preference 12 apn virtual2 domain virtual2
        virtual-apn preference 13 apn virtual3 domain virtual3
    exit
    apn real8
        virtual-apn preference 12 apn virtual7 domain virtual7
    exit
    apn real9
        virtual-apn preference 12 apn virtual5 domain virtual5
        virtual-apn preference 13 apn virtual6 domain virtual6
        virtual-apn preference 14 apn virtual7 domain virtual7
        virtual-apn preference 15 apn virtual8 domain virtual8
        virtual-apn preference 16 apn virtual9 domain virtual9
        virtual-apn preference 17 apn virtual10 domain virtual10
        virtual-apn preference 18 apn virtual2 domain virtual2
        virtual-apn preference 19 apn virtual3 domain virtual3
    exit
    apn real10
        virtual-apn preference 1 apn virtual11 domain virtual11
    exit
    exit
exit'''

// script will replace the dummy-SGI context with the chosen context
CP_SGi_Context = '''Config
    context dummy-SGi
        ip vrf MPN00002
        ip pool apn2_ip_pool_v4_001 209.165.201.1 255.255.255.224 private 0 group-name
apn2_ipv4_pool_group_01 vrf MPN00002 no-chunk-pool
        ip pool apn2_ip_pool_v4_002 209.165.201.3 255.255.255.224 private 0 no-chunk-pool
group-name apn2_ipv4_pool_group_02 vrf MPN00002
        ip pool apn2_ip_pool_v4_003 209.165.201.5 255.255.255.224 private 0 no-chunk-pool
group-name apn2_ipv4_pool_group_03 vrf MPN00002
        ip pool apn2_ip_pool_v4_004 209.165.201.7 255.255.255.224 private 0 no-chunk-pool
group-name apn2_ipv4_pool_group_04 vrf MPN00002
        ip pool apn2_ip_pool_v4_005 209.165.201.9 255.255.255.224 private 0 no-chunk-pool
group-name apn2_ipv4_pool_group_05 vrf MPN00002
        ip pool apn2_ip_pool_v4_006 209.165.201.11 255.255.255.224 private 0 no-chunk-pool
group-name apn2_ipv4_pool_group_06 vrf MPN00002
        ip pool apn2_ip_pool_v4_007 209.165.201.13 255.255.255.224 private 0 no-chunk-pool
group-name apn2_ipv4_pool_group_07 vrf MPN00002
        ip pool apn2_ip_pool_v4_008 209.165.201.15 255.255.255.224 private 0 no-chunk-pool
group-name apn2_ipv4_pool_group_08 vrf MPN00002
        ip pool apn2_ip_pool_v4_009 209.165.201.17 255.255.255.224 private 0 no-chunk-pool
group-name apn2_ipv4_pool_group_09 vrf MPN00002
        ip pool apn2_ip_pool_v4_010 209.165.201.19 255.255.255.224 private 0 no-chunk-pool
group-name apn2_ipv4_pool_group_10 vrf MPN00002

        ipv6 pool apn2_ip_pool_v6_001 prefix 2001:268:1::/48 private 0 no-chunk-
pool group-name apn2_ipv6_pool_group_01 vrf MPN00002
        ipv6 pool apn2_ip_pool_v6_002 prefix 2001:278:1::/48 private 0 no-chunk-
pool group-name apn2_ipv6_pool_group_02 vrf MPN00002
        ipv6 pool apn2_ip_pool_v6_003 prefix 2001:288:1::/48 private 0 no-chunk-
pool group-name apn2_ipv6_pool_group_03 vrf MPN00002
        ipv6 pool apn2_ip_pool_v6_004 prefix 2001:298:1::/48 private 0 no-chunk-
pool group-name apn2_ipv6_pool_group_04 vrf MPN00002
        ipv6 pool apn2_ip_pool_v6_005 prefix 2001:2A8:1::/48 private 0 no-chunk-

```

MODIFY_ENTERPRISE_INPUT_PARAMETERS.txt

```

pool group-name apn2_ipv6_pool_group_05 vrf MPN00002
  ipv6 pool apn2_ip_pool_v6_006 prefix 2001:2B8:1::/48 private 0 no-chunk-
pool group-name apn2_ipv6_pool_group_06 vrf MPN00002
  ipv6 pool apn2_ip_pool_v6_007 prefix 2001:2C8:1::/48 private 0 no-chunk-
pool group-name apn2_ipv6_pool_group_07 vrf MPN00002
  ipv6 pool apn2_ip_pool_v6_008 prefix 2001:2D8:1::/48 private 0 no-chunk-
pool group-name apn2_ipv6_pool_group_08 vrf MPN00002
  ipv6 pool apn2_ip_pool_v6_009 prefix 2001:2E8:1::/48 private 0 no-chunk-
pool group-name apn2_ipv6_pool_group_09 vrf MPN00002
  ipv6 pool apn2_ip_pool_v6_010 prefix 2001:2F8:1::/48 private 0 no-chunk-
pool group-name apn2_ipv6_pool_group_10 vrf MPN00002
  exit
exit'''

// UP VRF config
// script will replace the dummy-SGI context with the chosen context
UP_VRF_Config = '''config
  context dummy-SGI
    ip vrf MPN00002
      ip maximum-routes 100
    exit
  router bgp 65101
    ip vrf MPN00002
      route-distinguisher 65101 11100002
      route-target both 65101 11100002
    exit
  address-family ipv4 vrf MPN00002
    redistribute connected
  exit
  address-family ipv6 vrf MPN00002
    redistribute connected
  exit
  exit
  exit
exit
exit'''

```

MODIFY_ENTERPRISE_INPUT_PARAMETERS.txt

This file provides the IP pools that must be added to or deleted from an existing enterprise. The context name is determined based on the pool name.

Sample MODIFY_ENTERPRISE_INPUT_PARAMETERS.txt

```

OpType = "MODIFY_ENTERPRISE"
CP_APN_Config = '''Config
  context APN
    apn cisco.com
  exit
  exit
exit'''
CP_SGi_Context = '''Config
  context dummy-SGi
    no ip pool cisco_ip_pool_v4_002 209.165.202.129 255.255.255.224 private 0 no-chunk-pool
  group-name starent_ipv4_pool_group_01 vrf MPN00001
  ip pool starent_ip_pool_v4_003 209.165.202.132 255.255.255.224 private 0 no-chunk-pool
  group-name starent_ipv4_pool_group_01 vrf MPN00001
  exit
exit'''

```

DELETE_ENTERPRISE_INPUT_PARAMETERS.txt

This input file must contain APN, SGI context, and VRF details when the request is to remove the enterprise.

Sample DELETE_ENTERPRISE_INPUT_PARAMETERS.txt

Following is the example configuration for deleting a single APN.

```
OpType= "DELETE_ENTERPRISE"

CP_APN_Config = '''config
    context APN
        no apn cisco.com
    exit
exit'''

// script will replace the dummy-SGI context with the chosen context
CP_SGI_Context = '''config
    context dummy-SGI
no ip vrf MPN00001

    exit
exit'''

// UP VRF config
// script will replace the dummy-SGI context with the chosen context
UP_VRF_Config = '''config
    router bgp 65101
        no ip vrf MPN00001
    exit
exit'''
```

Following is the example configuration for deleting multiple virtual APNs in one DELETE operation.

```
CP_APN_Config = '''config
    context APN
        no apn virtual1
        no apn virtual2
        no apn virtual3
        no apn virtual4
        no apn virtual5
        no apn virtual6
        no apn virtual7
        no apn virtual8
        no apn virtual9
        no apn virtual10

        apn real1
            no virtual-apn preference 1
            no virtual-apn preference 2
            no virtual-apn preference 3
        exit
        apn real2
            no virtual-apn preference 3
            no virtual-apn preference 6
            no virtual-apn preference 9
        exit
        apn real3
            no virtual-apn preference 2
            no virtual-apn preference 5
            no virtual-apn preference 8
        exit
        apn real4
```

```

        no virtual-apn preference 2
        no virtual-apn preference 3
        no virtual-apn preference 5
    exit
    apn real5
        no virtual-apn preference 9
        no virtual-apn preference 8
        no virtual-apn preference 7
    exit
    apn real6
        no virtual-apn preference 13
        no virtual-apn preference 11
        no virtual-apn preference 12
    exit
    apn real7
        no virtual-apn preference 12
        no virtual-apn preference 13
    exit
    apn real8
        no virtual-apn preference 12
    exit
    apn real9
        no virtual-apn preference 19
        no virtual-apn preference 17
        no virtual-apn preference 13
        no virtual-apn preference 12
        no virtual-apn preference 15
        no virtual-apn preference 14
        no virtual-apn preference 16
        no virtual-apn preference 18
    exit
    apn real10
        no virtual-apn preference 1
    exit
exit'''

// script will replace the dummy-SGi context with the chosen context
CP_SGi_Context = '''config
    context dummy-SGi
        no ip vrf MPN00002

    exit
exit'''

// UP VRF config
// script will replace the dummy-SGi context with the chosen context
UP_VRF_Config = '''config
    router bgp 65101
        no ip vrf MPN00002
    exit
exit'''

```

System Limits

The following table depicts the maximum limits on ASR 5500 and CUPS.

Table 8: System Limits

Parameter	ASR 5500	Control Plane	User Plane
VRF Limit	300 per context 2048 per chassis	<ul style="list-style-type: none"> • 300 per context: Derived from the output of show ip user-plane verbose CLI command. • 1500 per chassis: Derived from the output of show ip user-plane verbose CLI command that is added across all contexts. 	205 VRF (with default routes); Derived from the output of show ip user-plane verbose CLI command. Must calculate per UP.
IP Pool Limit	IPv4: 2000 per context IPv6: 256 IPv6 per context 5000 per chassis (combined IPv4 and IPv6)	<p>IPv4: 2000 per context - Derived from the output of show ip user-plane verbose CLI command.</p> <p>IPv6: 256 IPv6 per context</p> <p>3400 per chassis (combined IPv4 and IPv6) - Derived from the output of show ip user-plane verbose CLI command.</p>	<p>Total of 600 IP pools per context per UP group:</p> <ul style="list-style-type: none"> • Total of 600 IP pools can consist a maximum of 256 IPv6 IP pools. • Total of 600 IP pools can consist a maximum of 600 IPv4 IP pools. <p>Derived from the output of show ip user-plane verbose CLI command. Must calculate the value from the output (Max 600 IPv4 pools, Max 256 IPv6 pools).</p>
APN Limit	2048	Total of 1500 for the system: Derived from the output of show cups-resource session summary CLI command.	205 per UP: Derived from the output of show cups-resource session summary CLI command. Must calculate per UP.

**Note**

- The IOB tool allows onboarding (OpType: ADD_ENTERPRISE) multiple APNs provided all those APNs share the "CP_SGi_Context" and "UP_VRF_Config" section of the input file. The APNs may potentially use different IP pool groups, but all those pool groups must be present in a single context in the "CP_SGi_Context" section of the input file. Also, the APNs must share a VRF. In such a case all those APNs onboard to the same UP group and SGi context.
- The tool supports deletion (OpType: DELETE_ENTERPRISE) of multiple APNs provided that all APNs share the "UP_VRF_Config" and "CP_SGi_Context" sections of the input configuration. The tool deletes the VRF and pools at the end of the operation. The intended use case for multiple APN deletes is to delete APNs that were onboarded together. The APNs onboarded together must be deleted together - the tool does not support separate deletion of APNs that were onboarded together.
- The tool does not support modification (OpType: MODIFY_ENTERPRISE) of multiple APNs in one operation. Only one APN can be modified at a time.
- The CUPSinfo.txt file is considered as the primary UP information. If any UP Groups are added in the system, but are not present in the file, then they are excluded from onboarding.

Enterprise Onboarding in CUPS OAM Support

This section describes operations, administration, and maintenance information for this feature.

Show Commands

show cups-resource session summary

This CLI command is introduced in support of the Enterprise Onboarding in CUPS solution. The output of this CLI command displays system-level resources on CP.

NOTES:

- Group Name Column displayed in output is the name of UP Group.
- Sx-IP shows the IP address of UP configured under the UP Group.
- APN, Active-Sessions, and LCI details are for the UP Group.

show ip user-plane verbose

The output of this CLI command is enhanced to display Total Pool Kernel Routes and Max Pool Kernel Routes fields. The dynamic IPv4 and IPv6 pool count is replaced with total IPv4 and IPv6 pool count. The output of this CLI command displays the context and UP Group it belongs to, and also adds information on number of IP pools and VRFs for that UP.

Error Codes

The following list of error codes is available in support of Enterprise Onboarding in CUPS feature.

Error Code	Description
1001	Indicates that the parsing of Input files has failed.
1002	Indicates that the parsing of Input_parameters file has failed.
1003	Indicates that the parsing of CUPSinfo file has failed.
1004	Indicates the inability to decrypt the passwords.
1005	Indicates that OpType is not present in input parameters.
1006	Indicates that the required configurations are not available in Input_parameters file for a given OpType.
1101	Indicates that the system pre-processing has failed.
1102	Indicates that the CPs pre-audit has failed for a given OpType.
1103	Indicates that the UPs pre-audit has failed for <UP_name>.
1107	Indicates that the tool is unable to update the CP_APN_Config section with the selected SGI context and UP Group. This indicates an error in the input configuration file.
1108	Indicates that the input file contains specified multiple APNs in a MODIFY_ENTERPRISE operation. This is not supported.
1301	Indicates that the CONTEXT and UPGROUP are not available for selection.
1401	Indicates the inability to find <context_name> and <group_name> from the CUPS system.
1501	Indicates the inability to get <context_name> from the output of show apn CLI command.
1601	Indicates that the configurations have failed for <control/user plane name> <connection state>.
1602	Indicates that the rollback configurations have failed for <control/user plane name> .
1701	Indicates that the CP post-audit has failed for <control plane name> <connection state>.
1702	Indicates that the UP post-audit has failed for <user plane name> <connection state>.
1703	Indicates that the Sx re-association has failed.



CHAPTER 26

Event-based CDRs for CUPS

This chapter includes the following topics:

- [Revision History](#), on page 219
- [Event-based CDRs for CUPS](#), on page 219
- [Feature Description](#), on page 219
- [How It Works](#), on page 220
- [Standards Compliance](#), on page 222
- [Monitoring and Troubleshooting](#), on page 222

Revision History



Note Revision history details are not provided for features introduced before release 21.24.

Revision Details	Release
First introduced	Pre 21.24

Event-based CDRs for CUPS

This chapter includes the following topics:

Feature Description

The CUPS architecture now supports Even-based Call Data Record (CDR) generation to account subscriber data usage. The EPC network, which consists of the User-Plane and Control-Plane as separate nodes, requires interaction between these entities to provide data usage accounting.

Generation of a CDR is an integral functionality of the Control-Plane. The Control-Plane interacts with the User-Plane to receive usage data such as: Uplink bytes, Downlink bytes and so on, to generate a CDR. These CDRs are generated based on Event Triggers. The event triggers can be either from the Access side of the

Control-Plane or PCRF generated. The usage data acquired from these events from the User-Plane, is updated in the CDR.

The following functionalities are supported in this feature:

- Exchange of Packet Flow Control Plane (PFCP) Session Modification Request and PFCP Session Modification Response messages.
- Reporting usage data from the User-Plane to the Control-Plane based on a configured Tariff-Time.



Note The scope of this feature is restricted only to P-GW and SAE-GW.

How It Works

The usage data report of a subscriber is retrieved from the User-Plane using the following mechanisms:

- **Pull mechanism:** The Control-Plane queries the User-Plane for the usage data report. The PFCP Session Modification Request/ PFCP Session Modification Response messages are used in this mechanism.
- **Push mechanism:** Here, the User-Plane sends the usage data report to the Control-Plane. The Tariff-Time configuration, which works with the existing Time/Volume-based push mechanism, is implemented. The PFCP Session Report Request/Session Report Response messages are used in this mechanism.

Fetching the Usage Report

In the CUPS architecture, because the User-Plane is a separate node, the Control-Plane node communicates with the User-Plane node using the PFCP protocol over the Sx interface to retrieve the usage data report of a subscriber.

The Control-Plane node sends the PFCP Session Modification request, containing the URRs for which the usage data report is reported. The User-Plane node responds with the PFCP Session Modification Response providing the usage data report for the requested URRs.

The following figure depicts the interaction between Control-Plane and User-Plane:

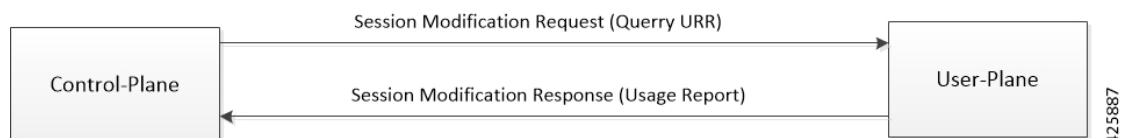

The following IEs are supported as part of the Sx Session Modification exchange messages:

- **Query URR:** This IE is present when the Control-Plane function requests immediate usage report(s) to the User-Plane function. Several IEs within the same IE type may be present to represent a list of URRs for which an immediate report is requested.
- **Usage Report:** This IE is present if the Query URR IE was present in the PFCP Session Modification Request and the traffic usage measurements for that URR are available at the User-Plane function. Several IEs within the same IE type may be present to represent a list of Usage Reports.

Tariff Time

Tariff-Time configuration is already supported by the Non-CUPS architecture. For CUPS, the Control-Plane uses the existing configuration. During a call set-up, PFCP Session Establishment Request carries the tariff time in the Monitoring Time IE, which is applicable to SDF URRs only. Bearer Level URR does not have this IE.

The Monitoring Time IE contains the configured time at which the usage data report of a subscriber is sent to the Control-Plane. Once the configured monitoring time expires the usage data report is sent, and sequentially, the time is automatically moved ahead by 24 hours indicating the time at which the next usage data report will be sent.



Note Before the next expiry of monitoring timer, usage data is reported continuously through the Time/Volume Threshold, if configured, or through an explicit request by the Control-Plane using the PFCP Session Modification Request (Query URR).

On the User-Plane, when the monitoring time expires for a URR, the Usage Report IE is sent to the Control-Plane. Sometimes, the monitoring time could expire for multiple subscribers at the same time. To avoid flooding of usage reports towards the Control-Plane, the User-Plane instead of reporting, piggybacks the usage data in the next outgoing message (PFCP Session Report Request or PFCP Session Modification Response) carrying the usage report.

The following IEs are supported as part of the Create URR IE within PFCP Session Modification Request:

- **Monitoring Time:** This IE contains the time at which the User-Plane function re-applies the volume or time threshold.
- **Subsequent Volume Threshold:** This IE may be present if the Monitoring Time IE is present and volume-based measurement is used. When present, it indicates the traffic volume value after which the User-Plane function reports the network resources usage to the Control-Plane function for the respective URR, for the period after the Monitoring Time.
- **Subsequent Time Threshold:** This IE may be present if the Monitoring Time IE is present and time-based measurement is used. When present, it indicates the traffic time value after which the User-Plane function reports the network resources usage to the Control-Plane function for the respective URR, for the period after the Monitoring Time.



Note In the non-CUPS architecture, P-GW supports four tariff-time instances in the Tariff-Time configuration. However, in CUPS only one tariff-time instance is supported.

Event Trigger

In this feature, an event trigger results in generation of either a partial CDR or a permanent CDR. In case of a partial event, only the CDR bucket is updated, but the actual CDR is not generated. But, in a permanent event trigger, a complete CDR is generated.

The following event triggers are supported in this feature:

- ULI Change (Partial event)

- Time Zone Change (Permanent event)
- Default Bearer QoS Change
- APN-AMBR Change



Note The GTPP trigger **egcdr max-losdv** is not supported in this release.

Standards Compliance

The Event-based CDRs for CUPS is based on the following standard(s):

- 3GPP TS 29.244: LTE; Interface between the Control Plane and the User Plane of EPC Nodes (3GPP TS 29.244 version 14.0.0 Release 14)

Monitoring and Troubleshooting

This section provides information on the show commands available to support Event-based CDRs for CUPS.

Show Commands and/or Outputs

This section provides information regarding show commands and/or their outputs in support of this feature:

show active-charging subscribers full callid *call_id* urr-info

On executing the above command the following new fields are displayed:

- Next Monitoring Time
 - Subsequent Time Threshold
 - Subsequent Volume Threshold

show subscribers user-plane-only callid *call_id* urr full all

On executing the above command the following new fields are displayed:

- Next Monitoring Time
 - Subsequent Time Threshold
 - Subsequent Volume Threshold



CHAPTER 27

Event Data Records in CUPS

- [Revision History, on page 223](#)
- [Feature Description, on page 223](#)
- [How It Works, on page 224](#)
- [Configuring Event Data Records in CUPS, on page 227](#)
- [Monitoring and Troubleshooting, on page 228](#)

Revision History



Note Revision history details are not provided for features introduced before release 21.24.

Revision Details	Release
Support is added to generate interim EDRs.	21.23.6
First introduced	Pre 21.24

Feature Description

Generation of Event Data Records (EDR) is supported in the CUPS architecture.

These EDRs are generated on termination of a flow. Detailed information for every flow is generated after the flow termination.

Following are the EDR fields that gets populated in the event of EDR generation due to the flow end, transaction complete, and so on or whenever the necessary conditions are met.

- P2P Duration
- Rating group
- RADIUS NAS Identifier
- 3GPP Charging-id

- SN-Parent Protocol-id

When the data traffic with TCP starts for a subscriber attached to LTE network. Need to calculate and record time difference between control packets of TCP flow in EDR. Need to record the difference between following packets:

- SYN and SYN-ACK packet
- SYN-ACK and ACK packet

TCP Fast Open

TCP Fast Open (TFO) is an extension to speed up the opening of successive TCP connections between two endpoints. It works by using a TFO cookie (a TCP option), which is a cryptographic cookie stored on the client and set upon the initial connection with the server. When the client later reconnects, it sends the initial SYN packet along with the TFO cookie data to authenticate itself. If successful, the server may start sending data to the client even before the reception of the final ACK packet of the three-way handshake. Due to this RTT between SYN-ACK and ACK is calculated based on difference between SYN-ACK packet and first uplink ACK packet.

How It Works

EDRs are generated from UP on flow termination. During call setup and call modification, all call-specific attributes required for EDR generation is sent from CP to UP as part of the Subscriber Params IE within the Sx Establishment/Modification request messages.

On flow termination, the charging counters are fetched from VPP. All configured call-level attributes in the EDR format configuration along with the charging / volume counter attributes is sent to the CDRMOD procllet. This procllet writes these records to a file/disk, which is transferred to a configured external server.



Note User-Location-Information is written in hexadecimal format.

Transaction Complete EDR

Transaction complete EDRs are generated for HTTP EDRs when a HTTP transaction is complete. On completion, the charging counter are fetched from VPP. All configured call-level attributes in the EDR format configuration along with the charging / volume counter attributes is sent to the CDRMOD procllet. This procllet writes these records to a file/disk, which is transferred to a configured external server.

The following list of EDR attributes are supported:

- attribute sn-start-time
- attribute sn-end-time
- attribute sn-start-time format MM/DD/YYYY-HH:MM:SS:sss
- attribute sn-end-time format MM/DD/YYYY-HH:MM:SS:sss
- attribute radius-calling-station-id

- attribute radius-called-station-id
- rule-variable bearer 3gpp imsi
- rule-variable bearer 3gpp imei
- rule-variable bearer 3gpp rat-type
- rule-variable bearer 3gpp user-location-information
- rule-variable ip subscriber-ip-address
- rule-variable ip dst-address
- attribute sn-ruledef-name
- attribute sn-subscriber-port
- attribute sn-server-port
- attribute sn-app-protocol
- attribute sn-volume-amt ip bytes uplink
- attribute sn-volume-amt ip bytes downlink
- attribute sn-flow-start-time format seconds
- attribute sn-flow-end-time format seconds
- attribute sn-volume-amt ip pkts uplink
- attribute sn-volume-amt ip pkts downlink
- attribute sn-direction
- rule-variable traffic-type
- rule-variable p2p protocol
- rule-variable p2p app-identifier tls-cname
- rule-variable p2p app-identifier tls-sni
- rule-variable p2p app-identifier quic-sni
- rule-variable bearer 3gpp sgsn-address
- attribute sn-rulebase
- attribute sn-charging-action
- rule-variable flow tethered-ip-ttl
- rule-variable flow ttl
- rule-variable flow ip-control-param
- rule-variable bearer qci
- rule-variable tcp flag
- rule-variable ip server-ip-address

- attribute sn-flow-id
- attribute sn-closure-reason
- attribute sn-duration
- rule-variable ip src-address
- rule-variable ip protocol
- attribute sn-charge-volume ip bytes uplink
- attribute sn-charge-volume ip bytes downlink
- tcp-state
- tcp-prev-state

The following HTTP EDR attributes are supported:

- rule-variable http url length 2000
- rule-variable http request method
- rule-variable http content type
- rule-variable http user-agent length 255
- rule-variable http reply code
- rule-variable http referer
- rule-variable http host
- rule-variable http cookie
- rule-variable http header-length
- attribute transaction-uplink-bytes
- attribute transaction-downlink-bytes

Support for Interim EDRs

ECS supports generation of Interim EDRs – EDRs that are generated for ongoing flows based on a configurable timer.

Usually, EDRs are generated for flows only when the flow terminates or when the flow reaches the configured flow idle-timeout value. These flows could have time duration that is as long as 48 hours, which makes it difficult to track subscriber activity until an EDR is generated.

Thus, with interim EDRs, ongoing flow activities are tracked by configuring an interim timeout value for a flow. On expiration of the interim timer, an EDR is generated.

For configuring an interim EDR, a new CLI keyword, **interim**, is introduced. Based on the configuration, the interim timer is applied to newly created flows. On expiration of the timer, an interim EDR is generated along with the following reason: **sn-closure-reason (23)**. The information volume available until the expiration of the timer is populated in the EDR along with its respective timestamps.

Limitations

The Event Data Record feature in CUPS has the following limitations:

- EDR will be generated only for flow end condition – idle timeout, hagr, normal flow termination & during end of session.
- Charging-Action based EDR configuration is not supported.
- Reporting EDRs are not supported.

Configuring Event Data Records in CUPS

Configuration on CP to Push EDRs to UP

Use the following configuration to push EDRs from CP to UP using PFD mechanism.



Note The CLI commands used in this configuration are part of the existing non-CUPS architecture.

```

active-charging service service_name
  rulebase rulebase_name
    flow end-condition { timeout | normal-end-signaling | session-end |
interim } charging-edr charging_edr_format_name
    edr transaction-complete http charging-edr charging_edr_format_name
    exit
    edr-format format_name
      attribute attribute_name
    end

```

NOTES:

- **flow end-condition**: This command allows you to configure the end condition of the session flows related to a user session and triggers EDR generation.
- **timeout**: Creates an EDR with the specified EDR format whenever a flow ends due to a timeout condition.
- **normal-end-signaling**: Creates an EDR with the specified EDR format whenever flow end is signaled normally.
- **session-end**: Creates an EDR with the specified EDR format whenever a subscriber session ends. By this option session manager creates an EDR with the specified format name for every flow that has had any activity since last EDR was created for the flow on session end.
- **charging-edr** *charging_edr_format_name*: Specifies the charging EDR format.
- **interim**: This condition specifies the interim threshold condition of the flow where an EDR is generated based on the configured timer value. The *interim_timer_value* is configured in minutes with a configurable range from 15 to 1440 minutes.
- The **interim** keyword is only applicable for new flows created and not on existing flows.

- **http**: Specifies HTTP protocol related configuration.

Configuration to Enable EDR Module on UP

Use the following configuration to enable EDR module on UP



Note The CLI commands used in this configuration are part of the existing non-CUPS architecture.

```
configure
 context context_name
   edr-module active-charging-service
 end
```

Configuring Additional TCP Fields

Prior to using the following CLI commands to configure additional TCP fields in the EDR, ensure that all the other EDR configurations are present.



Note For CUPS setup, once configuration is present on CP side, push those changes on UP using **push config-to-up all** command from CP.

```
configure
 active-charging service service_name
   edr-format edr_format_name
     [ no ] rule-variable tcp syn_synack_rtt priority 3
     [ no ] rule-variable tcp syn_synack_ack_rtt priority 4
 end
```

Monitoring and Troubleshooting

show user-plane-service statistics rulebase name *rulebase_name*

The following fields are displayed in support of this feature:

- Rulebase Name
 - EDRs
 - Charge Volume
 - Uplink Pkts
 - Uplink Bytes
 - Downlink Pkts

- Downlink Bytes
- Charging EDRs
 - Total Charging EDRs generated
 - EDRs generated for handoff
 - EDRs generated for timeout
 - EDRs generated for normal-end-signaling
 - EDRs generated for session end
 - EDRs generated for rule match
 - EDRs generated for hagr
 - EDRs generated for flow-end content-filtering
 - EDRs generated for flow-end url-blacklisting
 - EDRs generated for content-filtering
 - EDRs generated for url-blacklisting
 - EDRs generated for any-error packets
 - EDRs generated for firewall deny rule match
 - EDRs generated for transaction completion
 - EDRs generated for voip call end
 - EDRs generated for dcca failure handling
 - EDRs generated for TCP optimization on
 - EDRs generated for tethering signature change
 - EDRs generated for interim interval
 - Total Flow-Overflow EDRs
 - Total zero-byte EDRs suppressed
- EDRs generated for interim
 - Interval
- Total Rulebases

show active-charging rulebase statistics real-time

The following fields are displayed in support of this feature:

- Rulebase Name
- Charging EDRs

- Total Charging EDRs generated
 - EDRs generated for handoff
 - EDRs generated for timeout
 - EDRs generated for normal-end-signaling
 - EDRs generated for session end
 - EDRs generated for rule match
 - EDRs generated for hagr
 - EDRs generated for flow-end content-filtering
 - EDRs generated for flow-end url-blacklisting
 - EDRs generated for content-filtering
 - EDRs generated for url-blacklisting
 - EDRs generated for any-error packets
 - EDRs generated for firewall deny rule match
 - EDRs generated for transaction completion
 - EDRs generated for voip call end
 - EDRs generated for dcca failure handling
 - EDRs generated for TCP optimization on
 - EDRs generated for tethering signature change
 - EDRs generated for interim interval
 - EDRs generated for audio-end Sessions
 - EDRs generated for video-end Sessions
 - EDRs generated for voipout-end Sessions
 - Total Flow-Overflow EDRs
 - Total zero-byte EDRs suppressed

show active-charging edr-format all

The following fields are displayed in support of Additional TCP Fields in EDR feature:

- Service Name
 - EDR Format Name
 - rule-variable tcp syn-synack-rtt priority 3
 - rule-variable tcp synack-ack-rtt priority 4

Bulks Statistics

The following bulk statistic(s) are added in the ECS schema to support Event Data Records in CUPS:

- edrs-generated: Indicated the total number of EDRs generated.



CHAPTER 28

Error Indication and GTPU Path Failure Detection

- [Revision History, on page 233](#)
- [Feature Description, on page 233](#)
- [How It Works, on page 234](#)
- [Configuring Error Indication and GTPU Path Failure on Control Plane, on page 240](#)

Revision History



Note Revision history details are not provided for features introduced before release 21.24.

Revision Details	Release
First introduced	Pre 21.24

Feature Description

The User Plane (UP) function notifies an Error Indication message for a GTPU peer to the sender when a GTP-PDU is received with a TEID that does not exist. This ensures that there are no stale sessions or bearers and maintains consistency in the network.

Error Indication and GTPU Path Failure between CP and UP nodes are supported over SxA, SxB and SxAB. For the neighbor nodes, it is supported over the S1u/S5u interfaces.

Behavior variations of local-purge or signal-peer for error indication and GTPU path failure are considered in this implementation.

- When Error Indication is received, the UP communicates the TEID and GTPU-peer information with the CP to ensure deletion or modification of the GTPU-peer.
- On receiving GTPU packet with non-existing TEID, the UP generates and sends Error Indication with TEID and GTPU peer entries.
- The deletion of a session or a bearer is decided based on the path failure detection at CP or UP.

- GTPU path failure is detected using GTPU echo messages between UP nodes, and between the UP and CP nodes.

As per 3GPP TS 29.244, the following is implemented in this feature:

- The PFCP Session Report Request is sent over the Sxa and Sxb interface by the UP function to report information related to an PFCP session to the CP function.
- The PFCP Session Report Response is sent over the Sxa and Sxb interface by the CP function to the UP function as a response to the PFCP Session Report Request.
- Error Indication Report IE must be present if the Report Type indicates an Error Indication Report.
- Remote F-TEID is sent in the Error Indication Report to identify the remote F-TEID of the GTP-U bearer for which an Error Indication has been received at the UP function.
- The PFCP Node Report Request is sent over the Sxa and Sxb interface by the UP function to report information to the CP function that is not specific to an PFCP session.
- The PFCP Node Report Response is sent over the Sxa, Sxb; Sxc and N4 interface by the CP function to the UP function as a response to the PFCP Node Report Request.
- UPPath Failure Report will be present if the Node Report Type indicates a User Plane Path Failure Report.
- Remote GTP-U Peer includes the IP address of the remote GTP-U peer towards which a UP path failure has been detected.

How It Works

Error Indication Support

Error Indication Handling at CP

CP on receiving a PFCP Session Report Request triggered by Error Indication received on UP from a neighboring UP, responds with PFCP Session Report Response and sends a PFCP Session Modification Request towards UP to delete PDR, a FAR for dedicated bearer identified for removal or a PFCP Session Deletion Request to delete the session.

- The session or bearer will be locally purged on PGW-C on reception of PFCP Session Deletion Response or PFCP Session Modification Response from UP respectively.
- For SAEGW-C, signaling over EGTP is based on **local purge** and **page-ue** configuration for S1u.
- For SGW-C, signaling over EGTP on CP is based on **local purge** and **page-ue** configuration for S1u and local-purge and signal peer on S5u.

Error Indication Handling on UP

UP on receiving Error Indication initiates a PFCP Session Report Request with Error Indication Report that includes remote FTEID containing TEID and GTPU Peer address.

- For PGW-U, Error Indication messages is sent or received over S5u.

- For SAEGW-U, Error Indication message is sent or received over S1u.
- For SGW-U, Error Indication message is sent and received over S1u and S5u.

Error Indication Generation on UP

UP generates Error Indication with TEID and GTPU Peer Address towards a peer when a data packet is received with TEID for which a session or bearer does not exist.

Error Indication Call Flows

P-GW Default Bearer Error Indication Handling

The following call flow illustrates P-GW default bearer error indication handling with local purge.

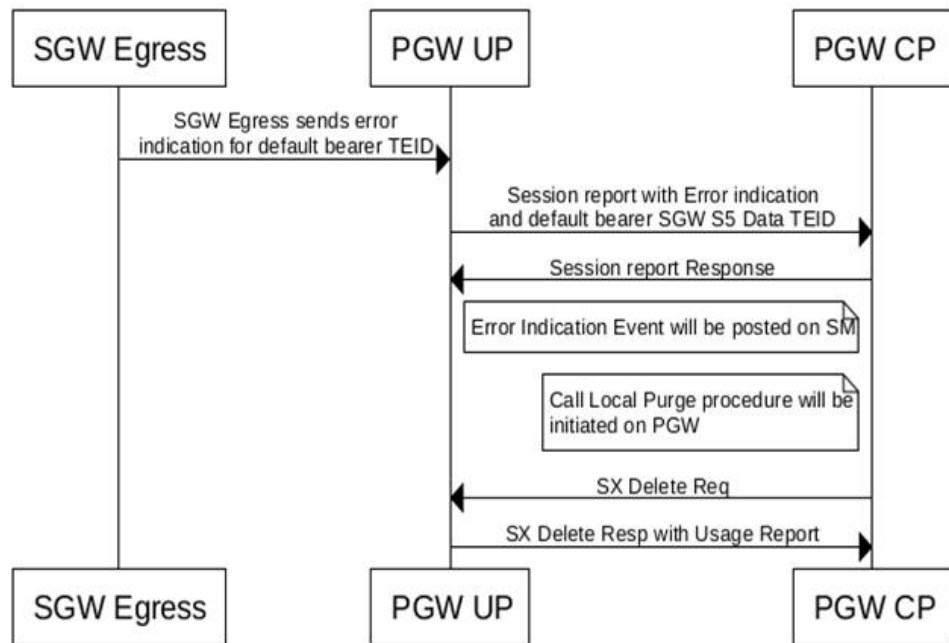

439309

P-GW Dedicated Bearer Error Indication Handling

The following call flow illustrates P-GW dedicated bearer error indication handling with local purge.

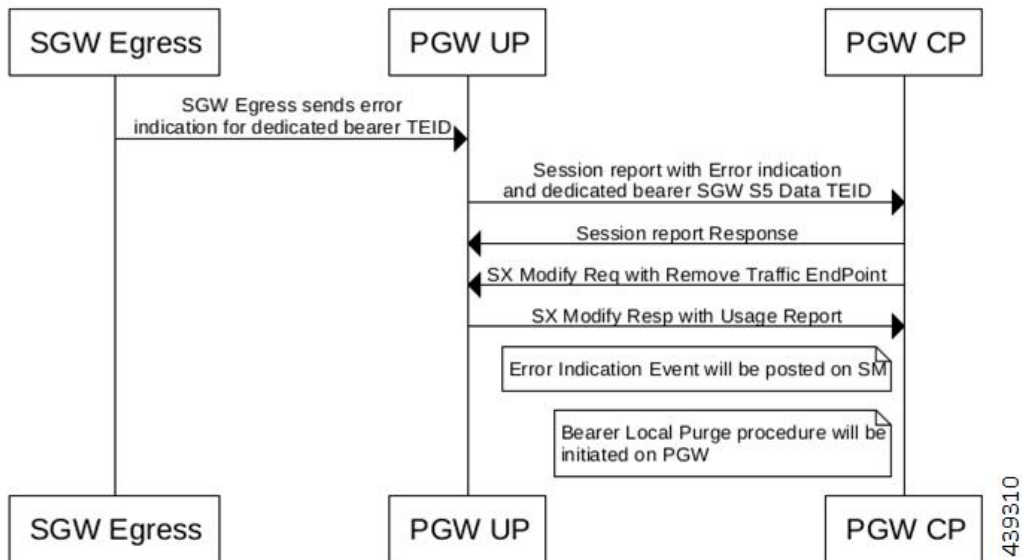

S-GW Default Bearer Indication Handling

The following call flow illustrates S-GW dedicated bearer error indication handling with S5u local purge.

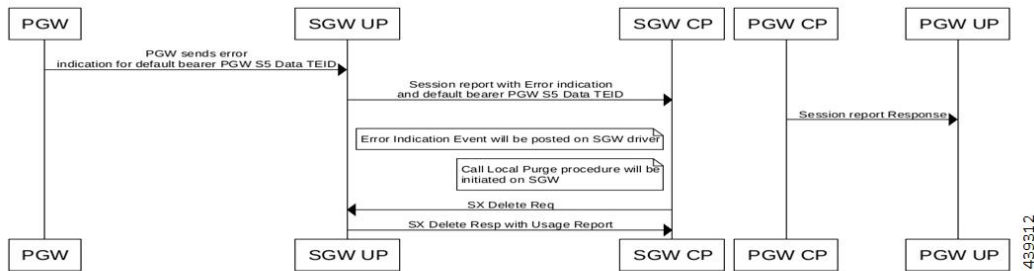

S-GW Dedicated Bearer Indication Handling

The following call flow illustrates S-GW dedicated bearer error indication handling with S1u local purge.

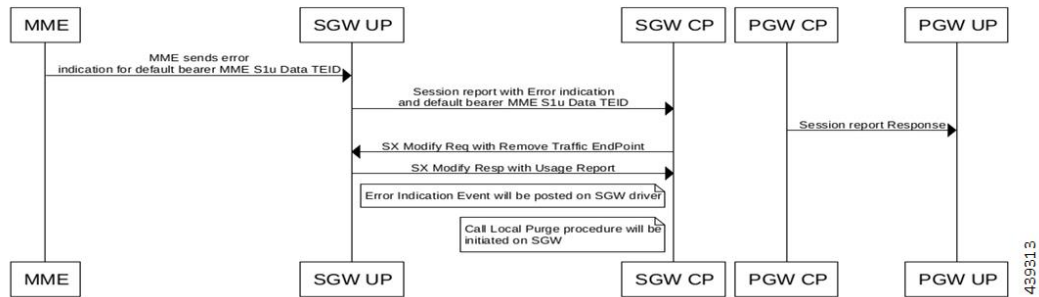

S-GW Dedicated Bearer Indication Handling

The following call flow illustrates S-GW dedicated bearer error indication handling with S5u local purge.

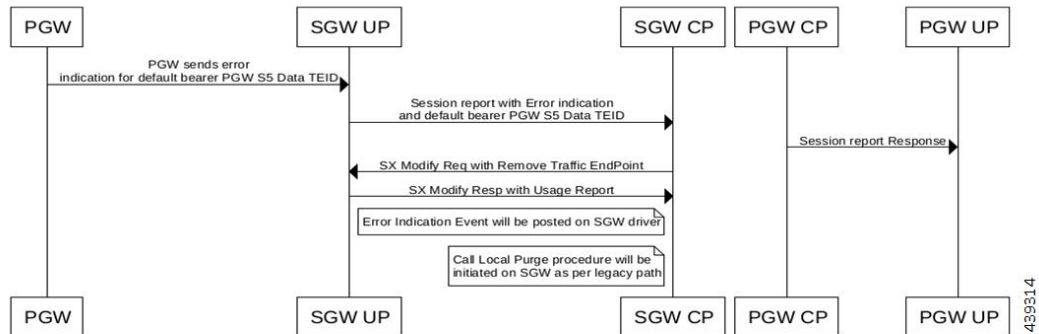

S-GW Dedicated Bearer Indication Handling

The following call flow illustrates S-GW dedicated bearer error indication handling with S5u signal peer.

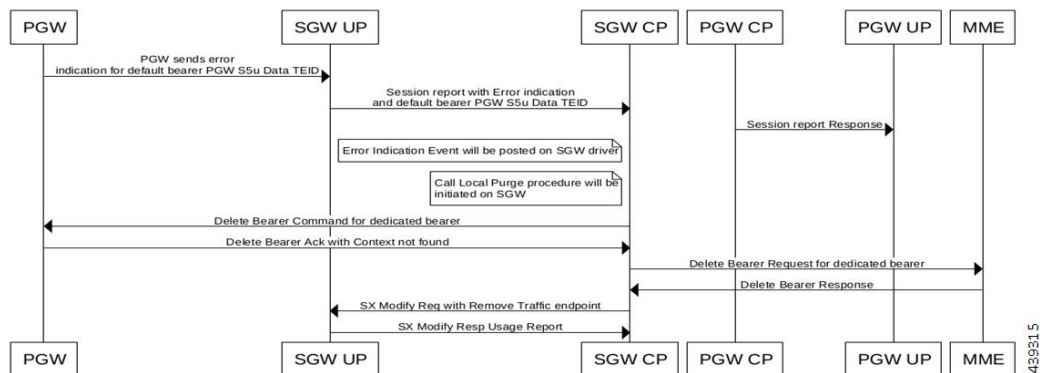

439315

GTPU Path Failure Support

GTPU Path Failure Support at CP

GTPU Echo Requests is initiated and sent periodically as per the configured interval on CP. GTPU Echo Response is sent for the GTPU Echo Request received from UP over the GTPU tunnel.

If Response is not received for the GTPU Echo Request, CP retries Echo Requests based on configured retransmission timeout and maximum retries. When retries are exhausted, CP initiates PFCP Session Deletion Request to delete the PFCP session.

On receiving the PFCP Node Report Request from UP, CP will send PFCP Node Report Response and initiate PFCP Session Deletion Request towards UP. Billing records will be generated when usage reports are received in PFCP Session Deletion Response.

The following call flow illustrates GTPU Path Failure handling at CP.

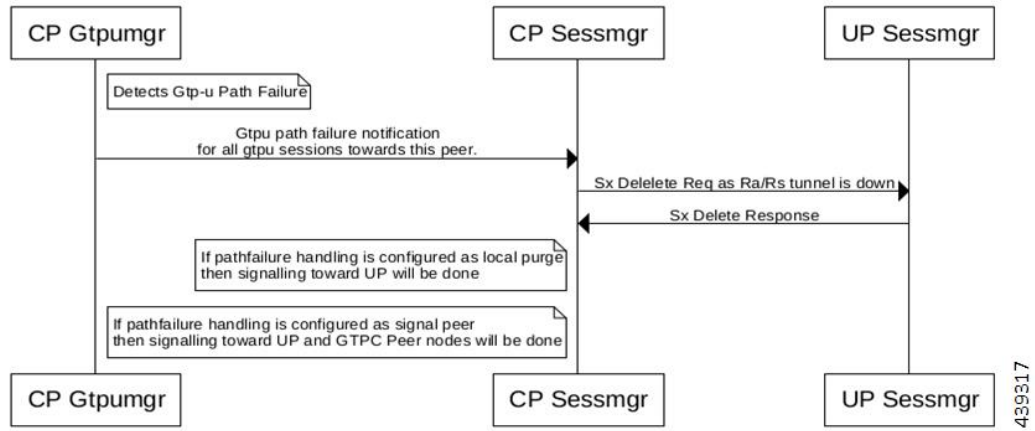

GTPU Path Failure Support at UP

GTPU Echo Requests is initiated and sent periodically as per the configured interval on UP. GTPU Echo Response is sent for the GTPU Echo Request received from CP over GTPU tunnel.

If Response is not received for the GTPU Echo Request, UP retries Echo Requests based on configured retransmission timeout and maximum retries. When retries are exhausted, UP shall initiate PFCP Node Report Request including (Node ID, Node Report Type, User Plane Path Failure Report including Remote GTP-U Peer).

If UP receives PFCP Node Report Response and PFCP Session Deletion Request to delete the session, it responds to the deletion request with usage reports.

The following call flow illustrates GTPU Path Failure support at UP

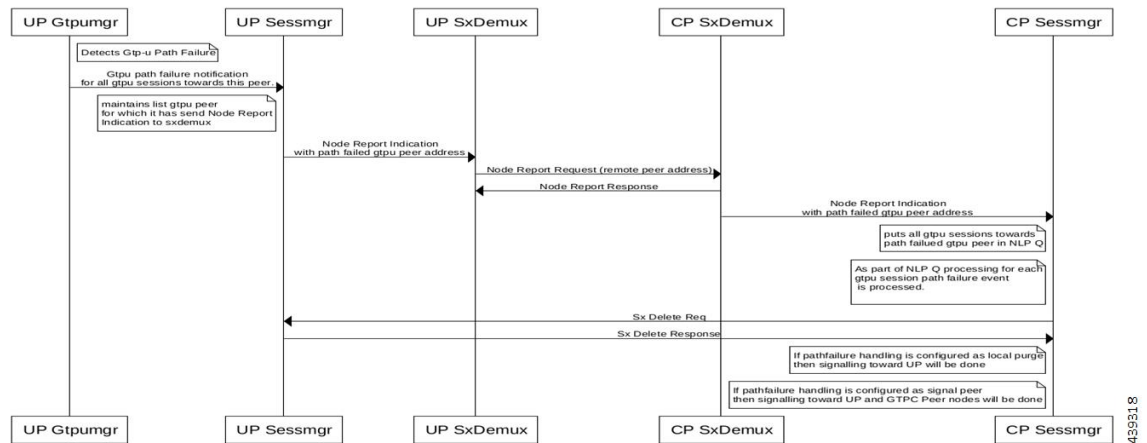

439318

Limitations

In this release, the Error Indication and GTPU Path failure feature has the following limitations:

- UP on receiving following messages/packets with Extension Headers will respond with Supported Extension Headers Notification indicating neighboring UPs that extension headers are not supported.
 - Error Indication
 - GTPU Echo Requests
 - GTPU Echo Response
 - GTP-PDU

Configuring Error Indication and GTPU Path Failure on Control Plane

Configuring Error Indication on CP

Use following commands to control the behavior of CP towards EGTP peers based on GTPU error indication received on a GTPU interface (s1u/s5u).

```

configure
  context context_name
    sgw-service service_name
  
```

```

    gtpu-error-ind { s1u { local-purge | page-ue } | s5u { local-purge
| signal-peer } }
    end

```

NOTES:

- **gtpu-error-ind:** Configures the actions to be taken upon receiving a GTP-U error indication from P-GW.
- **s1u:** Specifies the action to take when a GTP-U error indication is received from P-GW over the S1u interface.
- **s5u:** Specifies the action to take when a GTP-U error indication is received from P-GW over the S5u interface.
- **local-purge:** The S-GW clears the affected bearer (or PDN if error-indication is received on default bearer) locally without informing peer.
- **page-ue:** The S-GW moves the complete UE state to S1-Idle and starts paging for this UE.
- **signal-peer:** Clears the affected bearers or PDNs and initiates control signals towards the peer MME and P-GW.



Note The **extension-header source-udp-port** CLI option is not supported for GTP-U service on User Plane.

Configuring GTPU Path Failure on CP

Use following commands to control the behavior of CP towards EGTP peers based on GTPU path failure detected on GTPU interface (s1u/s5u).

```

configure
  context context_name
    sgw-service service_name
      path-failure { s1u | s5u } { local-purge | signal-peer }
    end

```

NOTES:

- **path-failure:** Configures the action to take upon the occurrence of a path failure between the S-GW and the MME or P-GW.
- **s1u:** Specifies the action to take when a GTP-U error indication is received from P-GW over the S1u interface.
- **s5u:** Specifies the action to take when a GTP-U error indication is received from P-GW over the S5u interface.
- **local-purge:** The S-GW clears the affected bearer (or PDN if error-indication is received on default bearer) locally without informing peer.
- **signal-peer:** Clears the affected bearers or PDNs and initiates control signals towards the peer MME and P-GW.

Limitations

The following CLI options are not supported in this release:

- In GTP-U service on UP: **extension-header source-udp-port**

- In SG-W service on CP:

gtpu-error-ind s4u

gtpu-error-ind s11u

gtpu-error-ind s12

path-failure s4u

path-failure s11u

path-failure s12

When Sx Session Modification Response for Error Indication or GTP-U Path Failure is pending from User Plane and Collapsed to Pure-P Handover request is received, Modify Bearer Request for Handover is processed once Sx Session Modification Response which was delayed is received. Following configuration is recommended for working of above case for handover to be successfully completed.

configure

```
context egresscontext_name  
  ims-auth-service service_name  
    policy-control  
      max-outstanding-ccr-u 2  
    end
```



CHAPTER 29

Firewall Support in CUPS

- [Revision History](#), on page 243
- [Feature Description](#), on page 243
- [Configuring the Default Firewall Feature](#), on page 244
- [Monitoring and Troubleshooting](#), on page 246
- [Show CLIs for CUPS](#), on page 247
- [SNMP Traps](#), on page 247
- [Reassembly Behavior Change](#), on page 248

Revision History



Note Revision history details are not provided for features introduced before release 21.24.

Revision Details	Release
First introduced	Pre 21.24

Feature Description

Subscriber Firewall feature on CUPS architecture allows you to configure Stateless and Stateful packet inspection and packet filtering to protect the subscribers from malicious attacks. The firewall configuration allows the system to inspect each packet of the subscriber data session. It also evaluates the security threat and applies the policies configured on uplink and downlink traffic.



Note The subscriber firewall implementation in CUPS is like the firewall implementation in non-CUPS architecture. For more details on the subscriber firewall in non-CUPS, see the *PSF Administration Guide*.

Overview

Firewall feature includes the support for the following:

- DoS attack
- DDoS attack
- Packet Filtering
- Stateless & stateful packet inspection
- Application level gateways
- SNMP thresholding and logging

Configuring the Default Firewall Feature

Following is the default configuration for the FW policy.

```
configure
    active-charging service service_name
    fw-and-nat policy policy_name
end
```

Along with the preceding service configuration, Following is the default CLI behavior of various FW related CLI within the service.

```
Dos-Protection:
  Source-Route           : Disabled
  Win-Nuke               : Disabled
  Mime-Flood            : Disabled
  FTP-Bounce            : Disabled
  IP-Unaligned-Timestamp : Disabled
  Seq-Number-Prediction  : Disabled
  TCP-Window-Containment : Disabled
  Teardrop              : Disabled
  UDP Flooding          : Disabled
  ICMP Flooding         : Disabled
  SYN Flooding         : Disabled
  Port Scan             : Disabled
  IPv6 Extension Headers Limit : Disabled
  IPv6 Hop By Hop Options : Disabled
  Hop By Hop Router Alert Option : Disabled
  Hop By Hop Jumbo Payload Option : Disabled
  Invalid Hop By Hop Options : Disabled
  Unknown Hop By Hop Options : Disabled
  IPv6 Destination Options : Disabled
  Invalid Destination Options : Disabled
  Unknown Destination Options : Disabled
  IPv6 Nested Fragmentation : Disabled

Max-Packet-Size:
  ICMP           : 65535
  Non-ICMP      : 65535

Flooding:
  ICMP limit    : 1000
  UDP limit     : 1000
  TCP-SYN limit : 1000
```

```

Sampling Interval           : 1

TCP-SYN Flood Intercept:
  Mode                     : None
  Max-Attempts             : 5
  Retrans-timeout         : 60
  Watch-timeout           : 30
Mime-Flood Params:
  HTTP Header-Limit       : 16
  HTTP Max-Header-Field-Size : 4096

No Firewall Ruledef Match Action:
  Uplink Action           : permit
  Downlink Action        : deny

TCP RST Message Threshold   : Disabled
ICMP Dest-Unreachable Threshold : Disabled
Action upon receiving TCP SYN packet with ECN/CWR Flag set : Permit
Action upon receiving a malformed packet : Deny
Action upon IP Reassembly Failure : Deny
Action upon receiving an IP packet with invalid Options : Permit
Action upon receiving a TCP packet with invalid Options : Permit
Action upon receiving an ICMP packet with invalid Checksum: Deny
Action upon receiving a TCP packet with invalid Checksum: Deny
Action upon receiving an UDP packet with invalid Checksum: Deny
Action upon receiving an ICMP echo packet with id zero : Permit
TCP Stateful Checks : Enabled
First Packet Non-SYN Action: Drop
ICMP Stateful Checks: Enabled
TCP Partial Connection Timeout: 30

```

Enabling Firewall for IPv4 and IPv6

Following is the configuration to enable the firewall for IPv4 and IPv6:

configure

```

active-charging service service_name
  fw-and-nat policy policy_name
    firewall policy ipv4-and-ipv6
  end

```

Configuration Support for Subscriber Firewall

The Control Plane pushes the required configuration for the subscriber firewall to the User Plane through PFD management. Firewall configurations are available under active charging configuration.

- Access-Rule-Defs
- Firewall-Nat Policy

Firewall feature configuration supports activation of firewall feature using rulebase, APN-based, and/or subscriber-based activation.

This section details the different aspect of configuration for the subscriber firewall in CUPS.

- Config delete command deletes the configuration immediately. It doesn't wait for bulk config timer as the said config is removed from the SCT and it's deleted from all Sessmgrs immediately.

- Addition/deletion/Modification of firewall configuration from CP to UP propagates using CLI command “push config-to-up all”.

Monitoring and Troubleshooting

Following is the show command output for the default Firewall feature on Control Plane.

show config active-charging service name acs verbose

```
fw-and-nat policy SFW_NAT_TEST
  no firewall dos-protection source-router
  no firewall dos-protection winnuke
  no firewall dos-protection mime-flood
  no firewall dos-protection ftp-bounce
  no firewall dos-protection ip-unaligned-timestamp
  no firewall dos-protection tcp-window-containment
  no firewall dos-protection teardrop
  no firewall dos-protection flooding udp
  no firewall dos-protection flooding icmp
  no firewall dos-protection flooding tcp-syn
  no firewall dos-protection port-scan
  no firewall dos-protection ipv6-extension-hdrs
  no firewall dos-protection ipv6-hop-by-hop
  no firewall dos-protection ipv6-hop-by-hop router-alert
  no firewall dos-protection ipv6-hop-by-hop jumbo-payload
  no firewall dos-protection ipv6-hop-by-hop invalid-options
  no firewall dos-protection ipv6-hop-by-hop unknown-options
  no firewall dos-protection ipv6-dst-options
  no firewall dos-protection ipv6-dst-options invalid-options
  no firewall dos-protection ipv6-dst-options unknown-options
  no firewall dos-protection ipv6-frag-hdr nested-fragmentation
  no firewall dos-protection ip-sweep tcp-syn
  no firewall dos-protection ip-sweep udp
  no firewall dos-protection ip-sweep icmp
  firewall max-ip-packet-size 65535 protocol icmp
  firewall max-ip-packet-size 65535 protocol non-icmp
  firewall flooding protocol icmp packet limit 1000
  firewall flooding protocol udp packet limit 1000
  firewall flooding protocol tcp-syn packet limit 1000
  firewall flooding sampling-interval 1
  firewall tcp-syn-flood-intercept mode none
  firewall tcp-syn-flood-intercept watch-timeout 30
  firewall mime-flood http-headers-limit 16
  firewall mime-flood max-http-header-field-size 4096
  no firewall icmp-destination-unreachable-message-threshold
  access-rule no-ruleddef-matches uplink action permit
  access-rule no-ruleddef-matches downlink action deny
  firewall tcp-idle-timeout-action reset
  no firewall tcp-reset-message-threshold
  firewall tcp-syn-with-ecn-cwr permit
  firewall malformed-packets drop
  firewall ip-reassembly-failure drop
  no firewall validate-ip-options
  firewall tcp-options-error permit
  firewall icmp-echo-id-zero permit
  firewall icmp-checksum-error drop
  firewall tcp-checksum-error drop
  firewall udp-checksum-error drop
  firewall tcp-fsm first-packet-non-syn drop
  firewall icmp-fsm
```

```
firewall policy ipv4-and-ipv6
firewall tcp-partial-connection-timeout 30
no nat policy
no nat binding-record
no nat pkts-drop edr-format
no nat pkts-drop timeout
default nat suppress-aaa-update
nat private-ip-flow-timeout 180
nat check-point-info basic limit-flows 100
nat check-point-info sip-alg
nat check-point-info h323-alg
nat max-chunk-per-realm single-ip
#exit
```

Show CLIs for CUPS

Following are the show CLIs for the CUPS:

For User Plane:

- show subscribers user-plane-only full all
- show subscribers user-plane-only flows
- show user-plane-service inline-services firewall statistics verbose
- show user-plane-service statistics rulebase all
- show alarm outstanding all
- show alarm outstanding all verbose
- show alarm statistics
- show user-plane-service statistics rulebase name <rulebasename>

For Control Plane:

- show active-charging fw-and-nat policy all
- show active-charging fw-and-nat policy name "fw_nat_policy_name"
- show active-charging firewall track-list attacking-servers
- show active-charging ruledef name

SNMP Traps

Following are the SNMP traps in support of this feature for CUPS, Use the respective trap CLIs on the User Plane to enable the trap.

- **DoS-Attacks:** When the number of DoS attacks exceed the set threshold value, the SNMP trap is generated, and the trap is cleared when the number falls below the threshold value within the time interval configured.
- **Drop-Packets:** When the number of packets dropped exceeds the threshold value, the SNMP trap is generated, the trap is cleared when the number falls below the threshold value within the time interval configured.

- **Deny-Rule:** When the number of Deny Rules exceeds the threshold value, the SNMP trap is generated, the trap is cleared when the number falls below the threshold value within the time interval configured.
- **No-Rule:** When the number of No Rules exceeds the threshold value, the SNMP trap is generated, the trap is cleared when the number falls below the threshold value within the time interval configured.

Reassembly Behavior Change

Following are the details about the CUPS reassembly, which are different from the non-CUPS architecture:

- In non-CUPS architecture, with the default FW configuration, fragments are buffered up to 64K bytes. Beyond 64K, all buffered and subsequent fragments are dropped. In non-CUPS architecture, this 64K limit was configurable from 30000 -> 65535. In CUPS, it is possible to reassemble the packet size of maximum 9k in a maximum of six fragments.
- Following are the four CLIs from the non-CUPS architecture that are deprecated in the CUPS:
 - firewall dos-protection teardrop
 - firewall dos-protection ipv6-frag-hdr nested-fragmentation
 - firewall max-ip-packet-size <30000-65535> protocol non-icmp
 - o firewall max-ip-packet-size <30000-65535>protocol icmp
- The following is a single CLI that covers teardrop attack, nested fragmentation, and general ip-reassembly-failure. Max-ip-packet size support is limited to six fragments (~9000 bytes).
 - o Firewall ip-reassembly-failure
- Following are the counters in firewall statistics, that gets incremented for all the attacks related to reassembly.
 - Packets Dropped due to IPv4 Reassembly Failure
 - Downlink Dropped Bytes on IPv4 Reassembly Failure
 - Uplink Dropped Bytes on IPv4 Reassembly Failure
 - Packets Dropped due to IPv6 Reassembly Failure
 - Downlink Dropped Bytes on IPv6 Reassembly Failure
 - Uplink Dropped Bytes on IPv6 Reassembly Failure



CHAPTER 30

FUI Redirection

- [Revision History](#), on page 249
- [Feature Description](#), on page 249
- [Appending Original URL to Redirect URL](#), on page 250

Revision History



Note Revision history details are not provided for features introduced before release 21.24.

Revision Details	Release
Added support for appending the original URL to the redirect URL.	21.28.m10
First introduced.	Pre 21.24

Feature Description

CUPS supports the Final Unit Indication (FUI) redirect feature on the Online Charging System (OCS) to configure automatic URL redirects for mobile subscribers whose quota is exhausted. When the subscriber quota is exhausted, this feature enables redirection to a pre-configured URL to recharge their account.

The OCS sends the FUI redirect information in one of the Diameter Attribute Value Pair (AVP) in the Credit Control Answer-Update (CCA-U) message. The FUI redirect information (when the feature is enabled at the OCS) is normally received when the OCS wants to indicate to the UPF that this is the last allocated unit before the subscriber quota is exhausted.

The FUI Redirection feature supports the following functionalities:

- FUI Redirection with HTTP URL
- FUI Redirection for the HTTP GET request
- Control the starting of validity timer for FUI redirect using the **diameter redirect-validity-timer immediate** CLI command.

The **traffic-start** keyword option is not supported.

- Control the behavior of marking redirected HTTP flow as free-of-charge using the **diameter fui-redirected-flow allow** CLI command. The redirected traffic gets redirected if the rule is executed from FUI-Redirect.

- Appending the original URL to the redirect URL

See the *Appending Original URL to Redirect URL* section for more information.

Limitations

The FUI Redirection feature has the following known limitations:

- No support for FUI Redirection with Filter-IDs or Filter-Rules.
- No support for token-based mechanism to exit redirection.
- No support for the WSP protocol in CUPS.
- No support for the **redirect-require-user-agent** CLI command to verify the presence of user agents in the HTTP header. Even if the user-agent is not configured, redirection works.

Appending Original URL to Redirect URL

UPF supports dynamic Advice of Charge (AoC) redirections with URL provided by Online Charging System (OCS). This redirection is performed for a particular Service ID/Rating Group combination without affecting the flows mapped to other Service ID/Rating Group combinations.

For redirection to an AoC or top-up server, the UPF appends the original HTTP URL to the redirected session. To append the original URL for redirection, the OCS indicates to the CP and UP by specifying a special "?" character to the end of the AoC redirection. The redirect URL will be appended with the original URL information using the token name configured with the **diameter redirect-url-token** command. The AoC server redirects the user to the original location on completion of AoC.

How it Works

The following is the procedure to append the original URL before redirection:

1. In the redirect URL, the "&" character replaces the "?" character at the end of the AoC page provided by OCS.
2. A configurable parameter will be appended after the "&" character. The parameter name is case sensitive. If the parameter is not configured, then the default string will be appended after the "&" character.
3. An "=" will be appended to the parameter.
4. The subscriber's original URL will be appended to the "=" character.
5. The original URL will be percent encoded.

Example:

Original URL:

```
http://homepage/
```

OCS provided URL:

```
http://test.dev.mms.ag/test/aoc.htm?appName=Return&CODE=UPSELL&OCSCode=FWB&SessionID=4:0001-diamprox.y.st40gy2;130020198;9243;1b02:12000:12000:H:AOC:1299597546:UPSELL:N&transID=AOCPurchasepage?
```

URL after append:

```
http://test.dev.mms.ag/test/aoc.htm?appName=Return&CODE=UPSELL&OCSCode=FWB&SessionID=4:0001-diamprox.y.st40gy2;130020198;9243;1b02:12000:12000:H:AOC:1299597546:UPSELL:N&transID=AOCPurchasepage&returnUrl=http%3A%2F%2Fhomepage%2F
```

Limitations

This feature has the following known limitation:

- If there is no existing configuration to enable URL parsing, the redirect URL will not get appended with the original URL.

Configuring Redirect URL Token

Configuring Redirect URL Token

To configure a token for appending the original URL to the redirect address, use the following configuration:

configure

```
active-charging service service_name
  credit-control
    diameter redirect-url-token token_string
  exit
```

NOTES:

- **diameter redirect-url-token** *token_string*: Specify the redirect URL token name as an alphanumeric string of size 1 through 63 characters.
- If this command is not configured and the received URL comes up with a "?" character at the end, then the default string "returnurl" will be appended after the "&" character.



CHAPTER 31

GGSN in CUPS

- [Revision History](#), on page 253
- [Feature Description](#), on page 253
- [How it Works](#), on page 255
- [Configuring GGSN in CUPS](#), on page 272

Revision History



Note Revision history details are not provided for features introduced before release 21.24.

Revision Details	Release
First introduced	Pre 21.24

Feature Description

The Gateway GPRS Support Node (GGSN) performs the following functions:

- Establish and maintain subscriber Internet Protocol (IP) or Point-to-Point Protocol (PPP) type Packet Data Protocol (PDP) contexts originated by either the mobile or the network
- Provide charging detail records (CDRs) to the charging gateway (CG, also known as the Charging Gateway Function (CGF))
- Route data traffic between the subscriber's Mobile Station (MS) and a Packet Data Networks (PDNs) such as the Internet or an intranet

PDNs are associated with Access Point Names (APNs) configured on the system. Each APN consists of a set of parameters that dictate how subscriber authentication and IP address assignment is to be handled for that APN.

GGSN is an existing StarOS application that runs on Cisco ASR 5500 and virtualized platforms. With this release, GGSN is supported in CUPS architecture.

For additional information on GGSN, refer the StarOS *GGSN Administration Guide*.

Supported Functionality

The following functionality are supported by GGSN in CUPS architecture:

- Initial Attach and Detach with Gx, Gy, and Gz
- Access side update procedures
- GGSN and QoS interaction scenarios
- 3G handoffs in GGSN
- GnGp inter-RAT handoff (Pure-P)
- GnGp inter-RAT handoff (Collapsed)
- PCRF initiated delete
- Direct Tunnel
- GGSN with RADIUS Authentication and Accounting
- GGSN with S6b interface
- Sx failure and GTP-C failure
- GTP-U path failure, GTP error indication
- Lawful Interception
- GGSN Statistics
- Idle timeout
- Session recovery and ICSR
- Support for context replacement
- Traffic End Point
- MS Information Change Procedure
- GGSN 2G support on CUPS

Standards Compliance

The GGSN in CUPS complies with the following 3GPP standards:

- 3GPP TS 23.060 release 16.0.0: 3rd Generation Partnership Project; Technical Specification Group Services and System Aspects; General Packet Radio Service (GPRS); Service description; Stage 2
- 3GPP TS 29.060 release 15.5.0: 3rd Generation Partnership Project; Technical Specification Group Core Network and Terminals; General Packet Radio Service (GPRS); GPRS Tunnelling Protocol (GTP) across the Gn and Gp interface
- 3GPP TS 23.214 release 14.0 - Universal Mobile Telecommunications System (UMTS); LTE; Architecture enhancements for control and user plane separation of EPC nodes.

- 3GPP TS 29.244 release 14.0 - LTE; Interface between the Control Plane and the User Plane of EPC Nodes.

How it Works

The following sections describes the various call flows related to the Gateway GPRS Support Node (GGSN) for CUPS.

Initial Attach GnGp

The following call flow describes the Create PDP Context (CPC) procedure during GnGp initial attach which is applicable for both EUTRAN (3G) and GERAN (2G).

Figure 7: Initial Attach (GnGp)

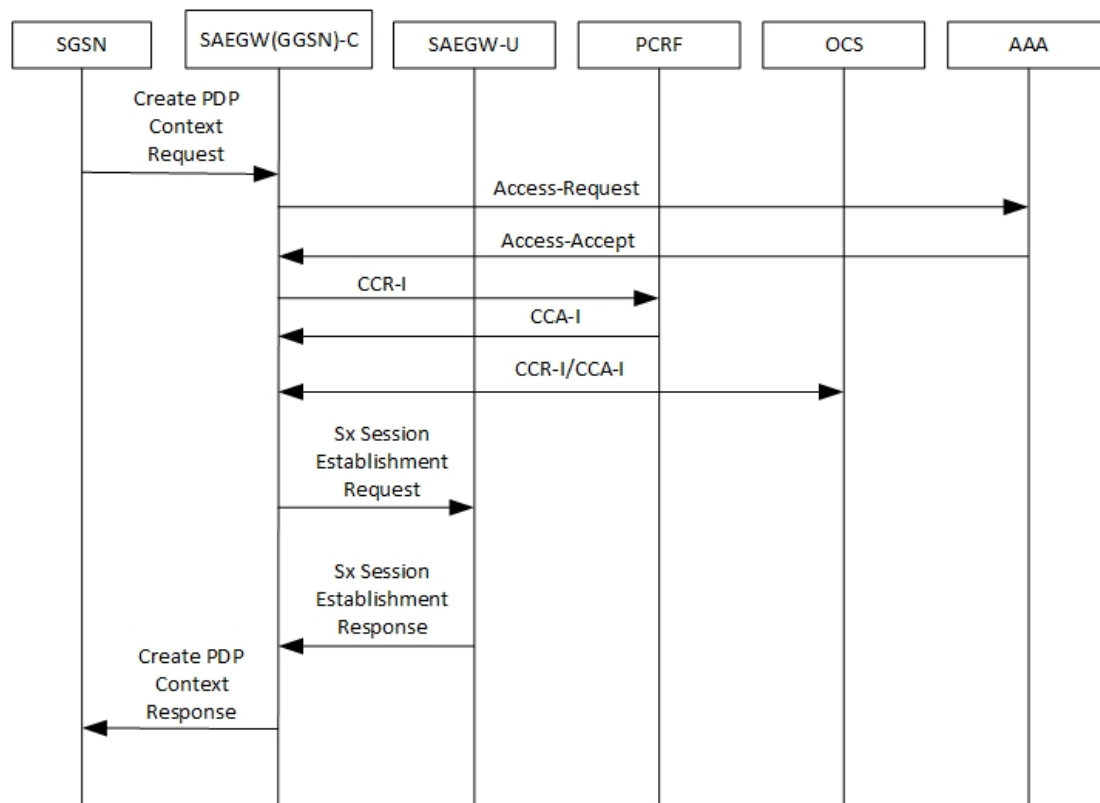

Table 9: Initial Attach (GnGp) Call Flow

Step	Description
1	The User Equipment (UE) initiates a General Packet Radio Service (GPRS) IP-CAN session establishment request to the Serving GPRS Support Nodes (SGSNs). The SGSN sends Establish IP-CAN Session (PDP context activation) Request to the SAEGW(GGSN)-C.

Step	Description
2a	The SAEGW(GGSN)-C sends the access request to AAA-interaction to query about the User-Name, calling-station-id, called-station-id, NAS-IPAddress, and RAT Type.
2b	The SAEGW(GGSN)-C sends the request to AAA-interaction to query about the s6b-AAR details: AAR {Session-ID, MIP6-Agent-Info (PGW-FQDN), User Name (IMSI-NAI), APN, RAT-Type} framed-ip-address
3a	The AAA interacts with GGSN for Access-Accept of: User-name, calling-station-id, called-station-id, framed-ip-address, nas-ipaddress
3b	The AAA interacts with GGSN for s6b-AAA details.
4	The SAEGW(GGSN)-C sends CCR-I to PCRF for IP-CAN session establishment procedure.
5	The PCRF responds with CCA-I for IP-CAN session establishment to SAEGW(GGSN)-C.
6a	The SAEGW(GGSN)-C sends the CCR-I request to OCS.
6b	The OCS responds with the CCA-I to SAEGW(GGSN)-C.
7	<p>After Gx, Gy, interaction Performs User Plane selection based on user-plane-profile configured with IP Pool (APN associated with IP Pool).</p> <ul style="list-style-type: none"> Establishes GTP-U session (required for RA/RS, in case of IPv6/IPv4v6 PDN). Performs Sxb interaction with selected User Plane for establishing GTP-U path with SGSN. <p>SAEGW(GGSN)-C sends Sx Session Establishment Request to SAEGW-U:</p> <ul style="list-style-type: none"> UL-PDR – PDI {src=access, local-ftcid: ch=1, UEIPAddress}, outer-header-removal) DL-PDR (PDI with UEIPAddress, Rulebase) UL-FAR (applyaction=forward, params=core, apn) DL-FAR (applyaction=forward, params=access, outer-header-creation gtpu-teid, gtpu-ipaddress) QER (correlation-id, mbr, gate-status) URR (measurement-method, reporting-trigger, volume/time thresholds) <p>Note</p> <ul style="list-style-type: none"> Create Uplink PDR is sent with "Outer Header Removal" based on IP address information in "Tunnel ID Data I" and "GSN Address" for Data. Create Downlink FAR is sent with "Outer Header Creation" as "Tunnel ID Data I" and "GSN Address" for Data.

Step	Description
8	The SAEGW(GGSN)-U sends Sx Session Establishment Response (Created-PDR, local-FTEID) to SAEGW-C. User Plane provides following information as part of Sx Session Establishment Response: <ul style="list-style-type: none"> Created PDR/Created Traffic End Point: GGSN Ingress F-TEID to be used as "Tunnel ID Data I" and "GSN Address" for Data.
9	On receipt of Sx Session Establishment Response, the SAEGW(GGSN)-C sends Create PDP Context Response toward SGSN with "Tunnel ID Data I" and "GSN Address" for Data from the information received in Sx Session Establishment Response.

Detach (GnGp)

The following call flow describes the Delete PDP Context (DPC) procedure during GnGp detach.

Figure 8: Detach (GnGp)

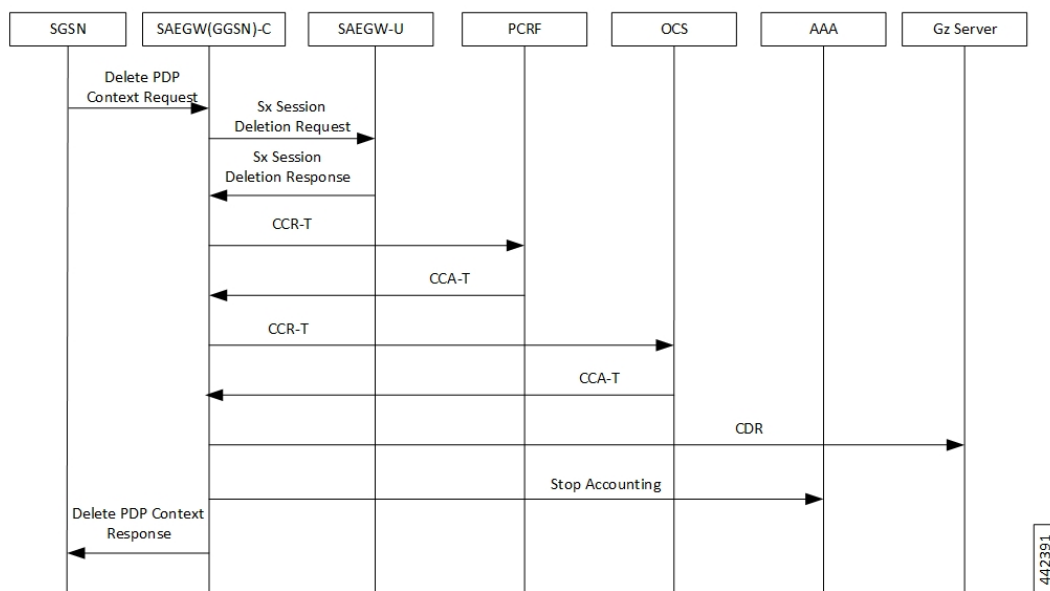

Table 10: Detach (GnGp) Call Flow

Step	Description
1	The SGSN sends a delete PDP Context Request (TEID, NSAPI, Teardown Ind) message to the SAEGW(GGSN)-C. If the MS in the Deactivate PDP Context Request message includes Teardown Ind, then the SGSN deactivates all PDP contexts associated with this PDP address by including Teardown Ind in the Delete PDP Context Request message.

Step	Description
2	On receipt of the Delete PDP Context Request from SGSN, the SAEGW(GGSN)-C does the following: <ul style="list-style-type: none"> • Removes GTP-U session (required for RA/RS in case of IPv6/IPv4v6 PDN). • Performs Sxb interaction and sends Sx Session Deletion Request to remove the Sx session context of an existing IP-CAN session.
3	The SAEGW-U responds with the Sx Session Deletion Response to SAEGW(GGSN)-C. On receipt of Sx Session Deletion Response, the SAEGW(GGSN)-C does the following: <ul style="list-style-type: none"> • Performs Gx communication (CCR-T and CCA-T). • Generates CDR (Gz) based on URR information received.
4	The GGSN-Initiated IP-CAN Session Termination: The SAEGW(GGSN)-C sends a CC Request (CCR) message with CC-Request-Type AVP set to TERMINATION_REQUEST.
5	The PCRF responds with CC Answer (CCA) message.
6	The SAEGW(GGSN)-C sends CCR-Terminate request to OCS.
7	The OCS responds with CCA-Terminate.
8	The SAEGW(GGSN)-C sends CDR to Gz server.
9	The SAEGW(GGSN)-C sends Stop-Accounting to AAA.
10	The SAEGW(GGSN)-C removes the PDP context(s) and returns a Delete PDP Context Response (TEID) message to the SGSN.

Context Replacement

When Context replacement occurs, the previous session in UP is deleted with Sxb interaction by exchanging Sx Session Deletion Request and Sx Session Deleting Response.

All CDRs of previous context are closed after receiving Sx Session Deletion Response.

NOTE: Rest of the Call flow remains same as Initial Attach.

Update Procedure and QoS Interaction

The following call flow describes the Update procedure and QoS interaction.

Figure 9: Update Procedure and QoS Interaction

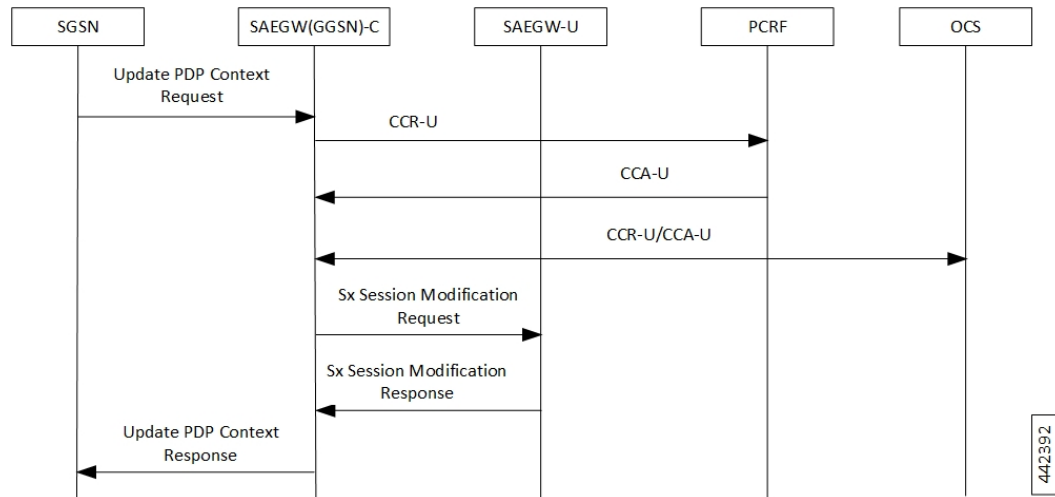

Table 11: Update Procedure and QoS Interaction Call Flow

Step	Description
1	The SGSN sends an Update PDP Ctx Request to SAEGW(GGSN)-C.
2	The SAEGW(GGSN)-C sends CC Request (CCR-U) message to PCRF.
3	The PCRF responds with CCA-U message, if the Result-Code is DIAMETER_SUCCESS.
4a	The SAEGW(GGSN)-C sends CCR-U to OCS.
4b	The OCS responds with CCA-U to SAEGW(GGSN)-C.
5	The SAEGW(GGSN)-C sends Sx Session Modification Request to SAEGW-U: <ul style="list-style-type: none"> • UL-Update-PDR (outer-header-removal) • DL-Update-PDR (fowrd-action, outer-hedae-creation, gtpu-address)
6	The SAEGW-U sends the Sx Session Modification Response to the SAEGW(GGSN)-C.
7	The SAEGW(GGSN)-C sends the Update PDP Ctx Response to SGSN.

Access side Update Procedure

QoS change received from Access-side, after being approved from PCRF, triggers:

- Update QER for APNAMBR/MBR changes
- Update FAR for any QCI/ARP changes for DSCP marking corresponding to new QoS

Gx Update Procedures

Following is the behavior of Gx update procedure through CCA-U or RAR:

- Common FAR is used for the PDRs if FAR attributes are the same.
- Rule installation triggers Create PDR and Create QER (SDF level), and may or may not have Create FAR and Create URR (rule can reuse FAR and URR of other rules).
- Rule modification for a flow status/rating group triggers Update QER/Update URR and may or may not have Update PDR (that is, no TFT/QoS change).
- Rule modification for TFT/QoS triggers Update PDR and may or may not have Update QER/Update URR (no QER/URR change).
- In case of update of (only) flow status/rating group, Update QER/URR is sent. That is, no Update PDR is sent in such cases.
- APN-AMBR change received from PCRF triggers Update QER.
- The default-eps-bearer-qos change, received from PCRF, triggers Update FAR if there is a change in DSCP marking corresponding to the new QoS.

PGW to GGSN Handoff

The following call flow describes the P-GW to GGSN Handoff procedure.

Figure 10: P-GW to GGSN Handoff

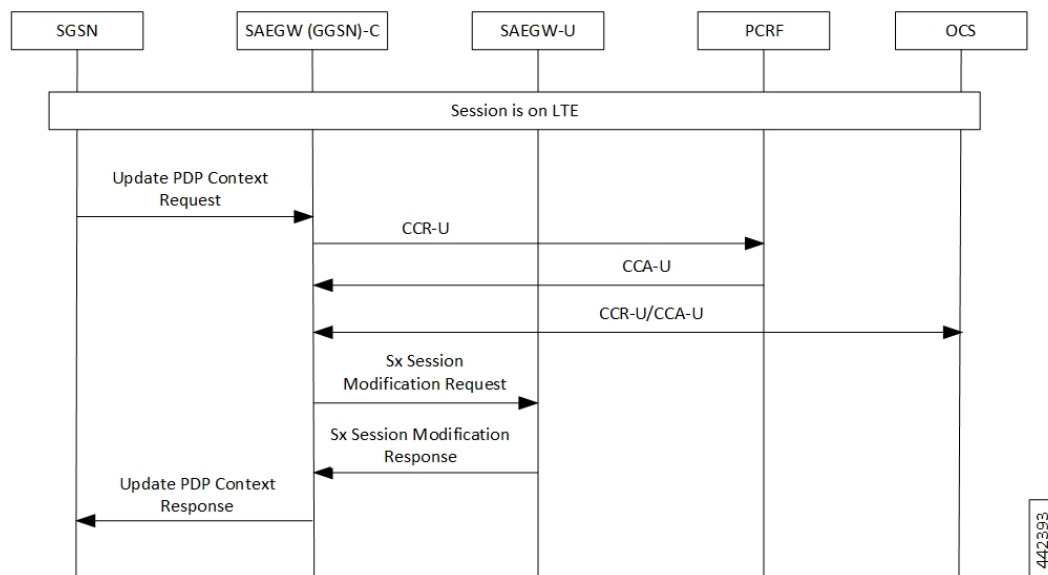

Table 12: P-GW to GGSN Handoff Call Flow

Step	Description
1	The target SGSN sends update PDP context request messages (new SGSN Address, SGSN Tunnel Endpoint Identifier, QoS negotiated, serving network identity, RAT type, MS Info Change Reporting support indication) to the SAEGW.
2	The SAEGW(GGSN)-C sends CCR-U to the PCRF.

Step	Description
3	The PCRF responds with CCA-U if the Result-Code is DIAMETER_SUCCESS for the IP can session modification.
4a	The SAEGW(GGSN)-C conditionally sends a CCR-U to the OCS if Online Charging is enabled.
4b	The OCS responds with a CCA-U to the SAEGW(GGSN)-C.
5	The SAEGW-C sends Sx Session Modify Request to SAEGW-U: <ul style="list-style-type: none"> • DL: Update the FAR for Target SGSN, update the URR, QER if modified • UL: Update PDR for Target SGSN IP Type, update the URR, QER if modified.
6	The SAEGW-U sends Sx Session Modify Response to SAEGW(GGSN)-C.
7	The SAEGW(GGSN)-C updates its PDP context fields and returns an Update PDP Context Response (TEID, Prohibit Payload Compression, APN Restriction, CGI/SAI/RAI change report required, BCM) message to the SGSN.

GGSN to PGW Handoff

The following call flow describes the GGSN to P-GW Handoff procedure.

Figure 11: GGSN to PGW Handoff

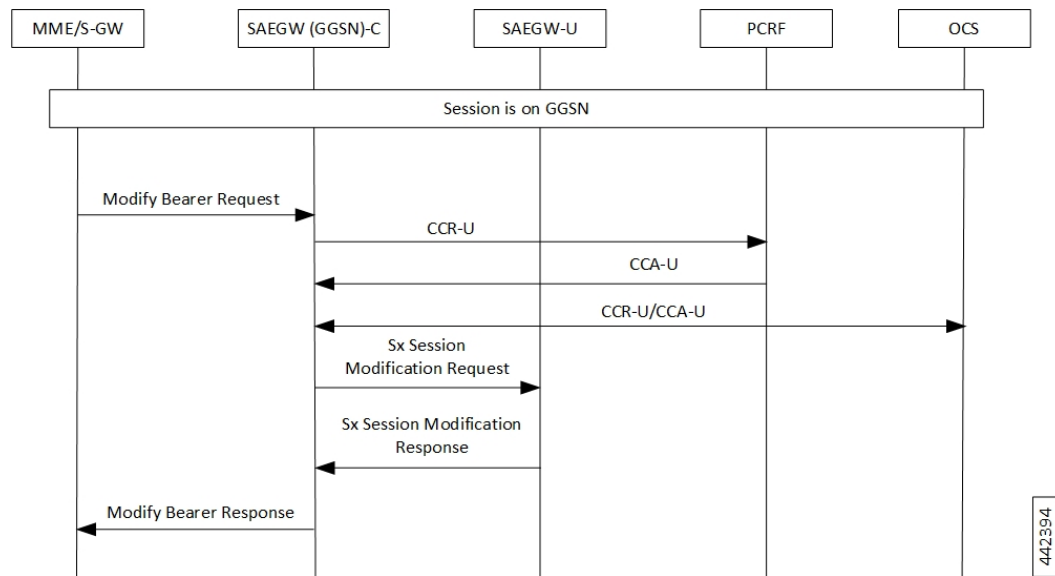

Table 13: GGSN to PGW Handoff Call Flow

Step	Description
1	The S-GW/MME sends a Modify Bearer Request (Sender F-TEID for Control Plane, Bearer Contexts to be modified [EBI, S5/S8-U SGW F-TEID], [UE-TZ]) to the SAEGW(PGW)-C.

Step	Description
2	The SAEGW(GGSN)-C sends CCR-U to the PCRF.
3	The PCRF responds with CCA for the IP can session modification.
4a	The SAEGW conditionally sends a CCR-U to the OCS if Online Charging is enabled.
4b	The OCS responds with a CCA-U to the SAEGW(GGSN)-C.
5	The SAEGW(GGSN)-C sends the Sx Modify Request to SAEGW-U: <ul style="list-style-type: none"> • DL: Update the FAR for Target S-GW/eNB, update the URR, QER if modified • UL: Update PDR depending S-GW/eNB IP Type, update the URR, QER if modified
6	The SAEGW-U responds with the Sx Modify Response to SAEGW(GGSN)-C with cause Success.
7	The SAEGW responds with Modify Bearer Response (Cause, MSISDN, Bearer Contexts Modified [EBI, Cause]) to the S-GW/MME.

Inter-SGSN Handoff Iu 3G to Iu 3G

An inter-SGSN, inter-system change from Iu mode to A/Gb mode takes place when an MS in PMM IDLE or PMM CONNECTED state changes from UTRAN or GERAN Iu mode to A/Gb mode and the A/Gb mode radio access node serving the MS is served by a different SGSN. In this case, the RA changes. Therefore, the MS initiates an A/Gb mode RA update procedure. The RA update procedure is either combined RA/LA update or only RA update. The MS or RAN decides to perform an inter-system change, which makes the MS switch to a new cell, where A/Gb mode must be used and stops transmission to the network.

The following call flow describes the GPRS Inter-SGSN Handoff procedure.

Figure 12: Inter-SGSN Handoff – Iu (3G) to Iu (3G)

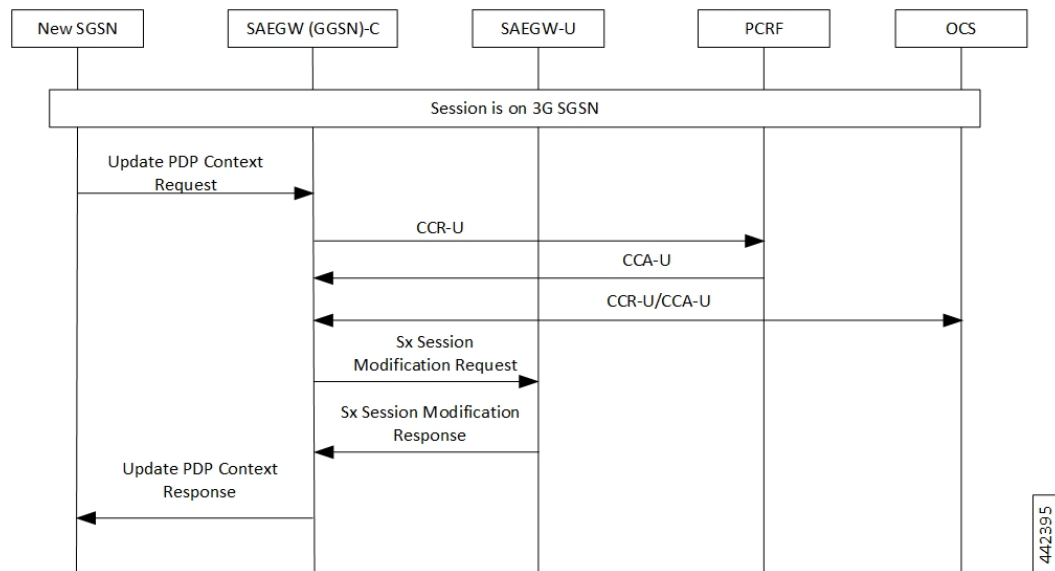

Table 14: Inter-SGSN Handoff – Iu (3G) to Iu (3G) Call Flow

Step	Description
1	The new SGSN sends an update PDP Context Request message to each SAEGW(GGSN)-C concerned.
2	The SAEGW(GGSN)-C conditionally sends CCR-U to the PCRF if RAT Type triggers are enabled.
3	PCRF responds with CCA-U for the IP can session.
4a	The GGSN conditionally sends a CCR-U to the OCS.
4b	The OCS responds with a CCA-U to the SAEGW(GGSN)-C.
5	The SAEGW(GGSN)-C sends the Sx Session Modify Request to SAEGW-U to update RNC IP and TEID that is received: <ul style="list-style-type: none"> • DL: Update the FAR for Target SGSN, update the URR, QER if modified • UL: Update PDR for Target SGSN IP Type, update the URR, QER if modified.
6	The SAEGW-U responds with the Sx Session Modify Response to SAEGW(GGSN)-C with cause-accept.
7	SAEGW(GGSN)-C sends Update PDP Ctx Response to new SGSN.

Inter SGSN Handoff for AGb 2G to Iu 3G

The call flow for Inter-SGSN Handoff 2G to 3G remains the same as Inter-SGSN Handoff – Iu (3G) to Iu (3G) with the difference being SAEGW(GGSN)-C remains and UE moves from 2G SGSN to 3G SGSN.

Inter SGSN Handoff for Iu 3G to AGb 2G

The call flow for Inter-SGSN Handoff 3G to 2G remains the same as Inter-SGSN Handoff – Iu (3G) to Iu (3G) with the difference being SAEGW(GGSN)-C remains and UE moves from 3G SGSN to 2G SGSN.

Direct Tunnel

The following call flow describes about the various nodes and interfaces for the Direct Tunnel.

Figure 13: Direct Tunnel

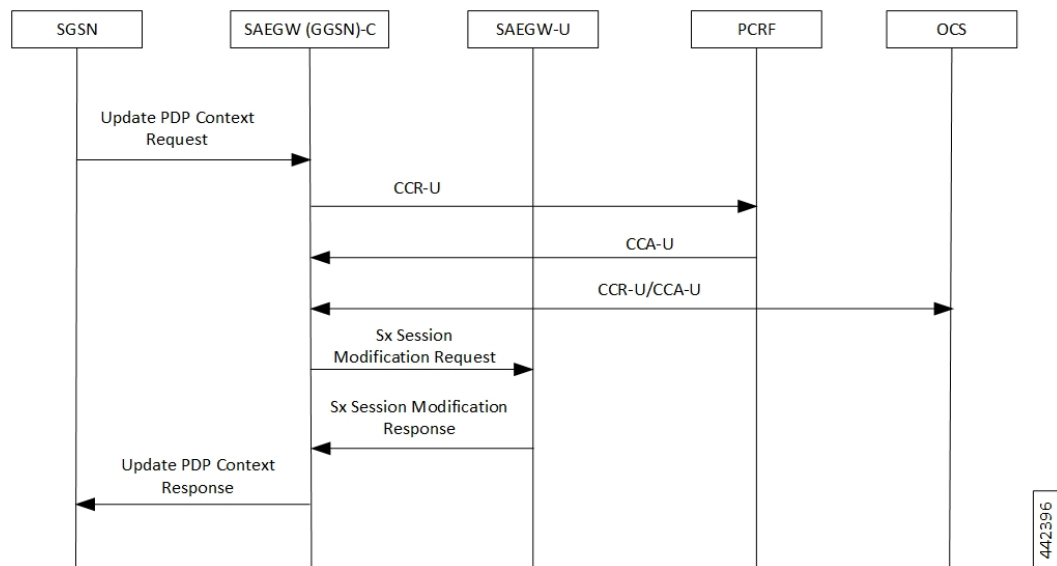

Table 15: Direct Tunnel Call Flow

Step	Description
1	After the call is established, if SGSN supports Direct Tunnel feature, SGSN will send Update PDP Context Request to GGSN including the DT IE with the DT Flag set to “1” along with RNC TEID and RNC IP in the SGSN Data TEID and SGSN Data IP fields respectively, to ensure data is directly forwarded to RNC and a direct tunnel between GGSN and RNC is established.
2	The SAEGW(GGSN)-C sends CCR-U to the PCRF.
3	The PCRF responds with CCA-U message.
4a	SAEGW(GGSN)-C sends CCR-U to OCS.
4b	OCS responds with the CCA-U to SAEGW(GGSN)-C.
5	The SAEGW(GGSN)-C sends the Sx Session Modify Request to SAEGW-U to update RNC IP and TEID that is received: <ul style="list-style-type: none"> • UL-Update-PDR (outer-header-removal) • DL-Update-FAR (Outer-header-creation)

Step	Description
6	The SAEGW-U responds with the Sx Session Modify Response to SAEGW(GGSN)-C with cause-accept.
7	SAEGW(GGSN)-C sends Update PDP Ctx Response to SGSN.

PCRF-initiated Deletion of Session

The following call flow describes about the various nodes and its related interfaces for PCRF-initiated deletion of session.

Figure 14: PCRF-initiated Deletion of Session

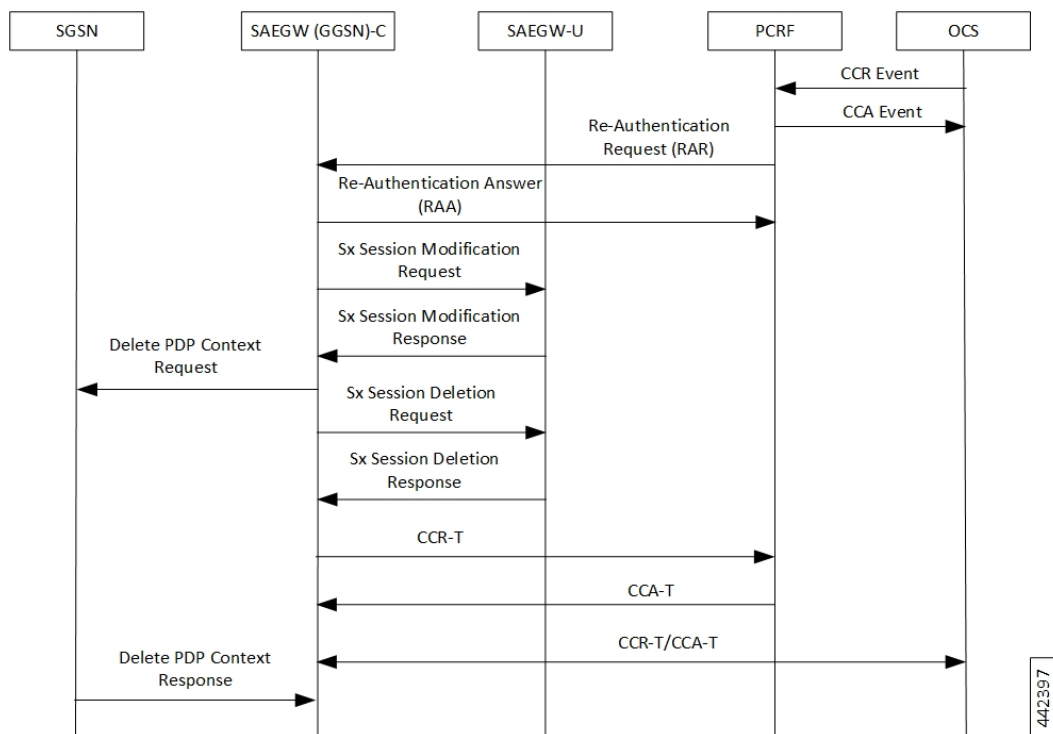

Table 16: PCRF-initiated Deletion of Session Call Flow

Step	Description
1	The PCRF sends a diameter Re-Authentication Request (RAR) to request that the SAEGW(GGSN)-C removes all the PCC rules previously installed for the IP CAN session and deactivates all the PCC rules previously activated for the IP CAN session.
2	The SAEGW(GGSN)-C respond with Re-Authentication Answer (RAA) message.
3	The SAEGW(GGSN)-C sends modification request to SAEGW-U and update FAR with Apply Action as “DROP” for both Uplink and Downlink data path.
4	The SAEGW-U responds with Sx Modification Response.

Step	Description
5	The SAEGW(GGSN)-C sends the Sx Delete Request to SAEGW-U. <ul style="list-style-type: none"> Removes GTP-U session (required for RA/RS in case of IPv6/IPv4v6 PDN). Performs Sxb interaction and sends Sx Session Deletion Request to remove the Sx session context of an existing IP-CAN session.
6	The SAEGW(GGSN)-C sends a Delete PDP Context Request (TEID, NSAPI, Teardown Ind) message to the SGSN in parallel.
7	After getting Sx Session Delete Response from SAEGW-U, SAEGW-C: <ul style="list-style-type: none"> Performs Gx/Gy communication (CCR-T and CCA-T). Generates CDR (Gz) based on URR information received.
8	The GGSN sends a CC Request (CCR) message with CC-Request-Type AVP set to TERMINATION_REQUEST.
9	The PCRF responds with CC Answer (CCA) message.
10	SAEGW(GGSN)-C generates CCR-Terminate on the Gy interface.
11	OCS responds with CCA-Terminate.
12	The SGSN removes the PDP context(s) and returns a Delete PDP Context Response (TEID) message to the SAEGW(GGSN)-C.

Admin Clear

The following call flow describes about the various nodes and its related interfaces for Admin Clear.

Figure 15: Admin Clear

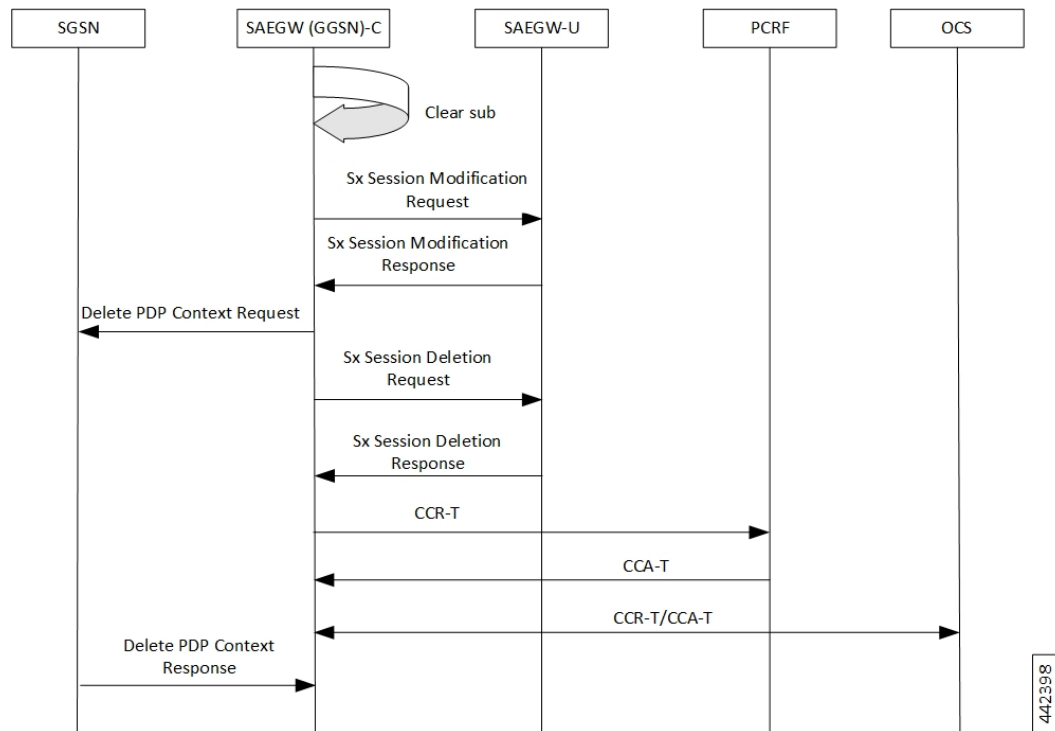

Table 17: Admin Clear Call Flow

Step	Description
1	Admin initiates session clearing using existing (non-CUPS CLI that is applicable in CUPS architecture) clear sub imsi CLI command.
2	The SAEGW(GGSN)-C sends modification request to SAEGW-U and update FAR with Apply Action as “DROP” for both Uplink and Downlink data path.
3	The SAEGW-U responds with Sx Modification Response.
4	The SAEGW(GGSN)-C sends Sx Delete Request to SAEGW-U: <ul style="list-style-type: none"> Removes GTP-U session (required for RA/RS in case of IPv6/IPv4v6 PDN). Performs Sxb interaction and sends Sx Session Deletion Request to remove the Sx session context of an existing IP-CAN session.
5	The SAEGW(GGSN)-C sends a Delete PDP Context Request (TEID, NSAPI, Teardown Ind) message to the SGSN in parallel.
6	After getting Sx Session Delete Response from SAEGW-U, the SAEGW(GGSN)-C: <ul style="list-style-type: none"> Performs Gx/Gy communication (CCR-T and CCA-T). Generates CDR (Gz) based on URR information received.

Step	Description
7	The SAEGW(GGSN)-C sends a CC Request (CCR) message with CC-Request-Type AVP set to TERMINATION_REQUEST.
8	The PCRF responds with CC Answer (CCA) message.
9	SAEGW(GGSN)-C generates CCR-Terminate on the Gy interface.
10	OCS responds with CCA-Terminate.
11	The SGSN removes the PDP context(s) and returns a Delete PDP Context Response (TEID) message to the SAEGW(GGSN)-C.

Network Failures

All possible network failure scenarios are also supported, which includes:

- Sx failures
- GTP failures – GTP-C Path Failure, GTP-U Path Failure, GTP Error Indication
- Gx failures
- Idle timeout and Bearer Inactivity Timeout

GGSN Session Reporting with Gy Interface

The session reporting functionality with Gy interface for GGSN is similar to P-GW. For details, refer the *P-GW Session Reporting with Gy Interface* section in the *Ultra Packet Core CUPS Control Plane Administration Guide*.

GGSN Session Reporting with Gz Interface

The session reporting functionality with Gz interface for GGSN is similar to P-GW. For details, refer the *P-GW Session Reporting with Gz Interface* section in the *Ultra Packet Core CUPS Control Plane Administration Guide*.

Secondary PDP Context Behavior

As secondary PDP context is not supported for GnGp GGSN CUPS, any request for Secondary PDP Context gets rejected as explained in the following scenarios:

SGSN Initiated Secondary PDP Context

The Create PDP Context (CPC) Request for Secondary PDP Context is rejected with cause as bearer handling not supported (230), as shown in the following call flow.

Figure 16: SGSN Initiated Secondary PDP Context

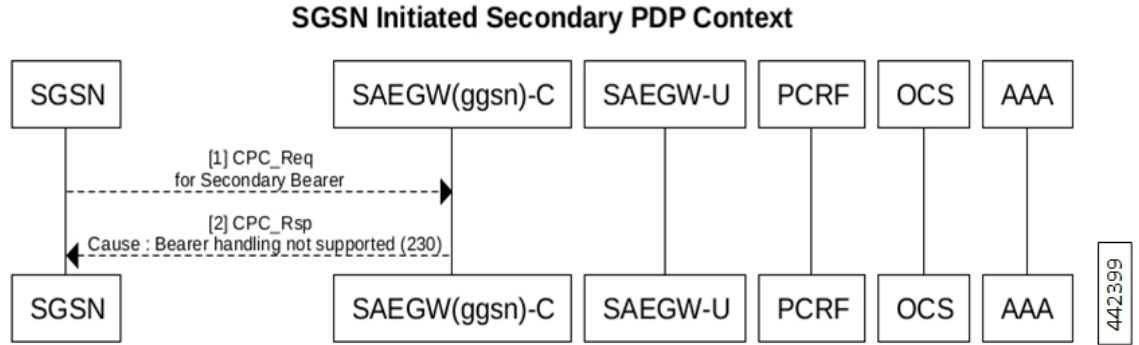

Table 18: SGSN Initiated Secondary PDP Context Call Flow

Step	Description
1	The SGSN sends a GTP Create PDP Context for Secondary Bearer to GGSN.
2	The GGSN sends a GTP Create PDP Ctxt Response with cause set to “Bearer Handling Not Supported (230)”.

PCRF initiated Secondary PDP Context

The rule mapping to Secondary PDP Context is not activated and CCR-U is sent to PCRF indicating the failed rule, and Rule-Failure-Code is set to RESOURCE_ALLOCATION_FAILURE (10). The behavior is similar for such rule received in CCA-I, CCA-U or RAR as shown in the following call flow.

Figure 17: PCRF Initiated Secondary PDP Context

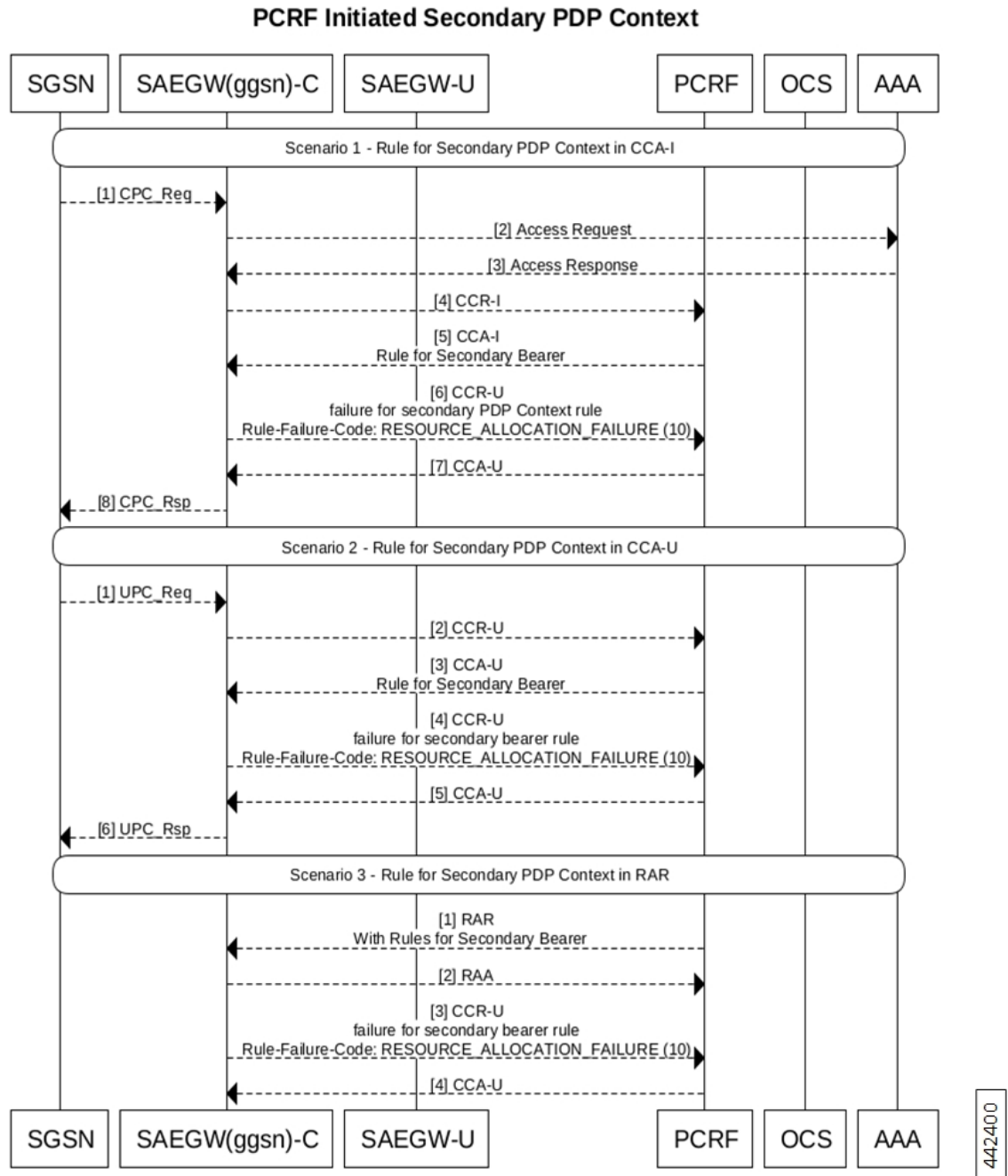

Table 19: PCRF Initiated Secondary PDP Context (Scenario 1)

Step	Description
1	The UE initiates a GPRS IP-CAN session establishment request to the SGSN. The SGSN sends Establish IP-CAN Session (Primary PDP context activation) request to the GGSN.

Step	Description
2a	The GGSN sends the access request to AAA-interaction to query about the User-Name, calling-station-id, called-station-id, NAS-IPAddress, and RAT Type.
2b	The GGSN sends the request to AAA-interaction to query about the s6b-AAR details: AAR {Session-ID, MIP6-Agent-Info (PGW-FQDN), User Name (IMSI-NAI), APN, RAT-Type} framed-ip-address
3a	The AAA interacts with GGSN for Access-Acceptance of: User-name, calling-station-id, called-station-id, framed-ip-address, nas-ipaddress
3b	The AAA interacts with GGSN for s6b-AAA details.
4	The GGSN sends request to PCRF for IP-CAN session establishment procedure.
5	The PCRF responds with CCA for IP-CAN session establishment to GGSN.
6	The CCR-U contains the Charging-Rule-Report AVP with Charging rule name, with PCC-Rule-Status as INACTIVE and Rule-Failure-Code as “RESOURCE_ALLOCATION_FAILURE (10)”.
7	The PCRF respond with CCA-U to GGSN
8	The GGSN sends a GTP Create PDP Ctxt Response to SGSN.

Table 20: PCRF-initiated Secondary PDP Context (Scenario 2)

Step	Description
1	The SGSN sends the Update PDP Ctx Request to GGSN.
2	The GGSN sends the access request to AAA-interaction.
3	The AAA interacts with GGSN for Access Request -Acceptance.
4	The GGSN sends CCR Request to the PCRF. The SGSN change may require GGSN – PCRF exchange to update QoS profile, based on RAT change, Lawful Intercept update, or other conditions. This exchange may be required to update MS profile and/or billing codes, for example, this profile information may overlap with QoS information received from the HLR through the vSGSN during PDP Context Request message, in such cases, any variance in overlap values, the PGW uses these PCRF (Gx) values.
5	The PCRF responds with CC Answer (CCA) Update message. A rule is also received for the secondary bearer creation, if the Result-Code is DIAMETER_SUCCESS.
6	The CCR-U contains the Charging-Rule-Report AVP with Charging rule name, with PCC-Rule-Status as INACTIVE and Rule-Failure-Code as “RESOURCE_ALLOCATION_FAILURE (10)”.
7	The PCRF respond with CCA for IP-CAN session establishment to GGSN
8	The GGSN sends a GTP Update PDP Ctxt Response to SGSN.

Table 21: PCRF-initiated Secondary PDP Context (Scenario 3)

Step	Description
1	The RAR command is sent by the PCRF to the PCEF in order to provision PCC rules using the PUSH procedure to initiate the provision of unsolicited PCC rules. A rule is also received for the secondary bearer creation.
2	The RAA command is sent by the PCRF to the PCEF in order to provision PCC rules using the PUSH procedure initiate the provision of unsolicited PCC rules.
3	The CCR-U contains the Charging-Rule-Report AVP with Charging rule name, with PCC-Rule-Status as INACTIVE and Rule-Failure-Code as “RESOURCE_ALLOCATION_FAILURE (10)”.
4	The PCRF responds with CCA-U to GGSN.

Recovery and ICSR for GGSN in CUPS

Existing framework is extended to support GGSN in CUPS Recovery and ICSR. At GGSN in CUPS, complete session/PDN state is recovered in case of Recovery/ICSR.

NOTE: In this release, if ICSR Switchover is performed on GGSN in CUPS, then the **show sx peers** CLI commands does not show any associated peers on New Active chassis. However, there is no impact to functionality.

Limitations

In this release, the functionality listed in *Supported Functionality* section are supported for GGSN (GnGp) in CUPS.

The following features/functionality are not supported for GGSN in CUPS:

- Custom Dictionaries – Only Standard Dictionaries are supported unless specifically mentioned.
- Non-standard QCIs are not supported.
- Custom CLI or features are not supported.



Note Customer-specific CLI commands supported for GGSN in CUPS architecture are listed in *Supported Custom CLI Commands*.

- The PDP Type PPP, RADIUS CoA, and Gi tunneling protocols are not supported.

Configuring GGSN in CUPS

This section describes the CLI commands that are available in support of this feature.

Enabling CUPS in GGSN Service

Use the following configuration to enable CUPS in GGSN service.

```
configure
  context context_name
    ggsn-service service_name
      [ no ] cups-enabled
    end
```

NOTES:

- The following services should be in STARTED state, and associated under SAEGW service for SAEGW service to move to STARTED state:
1. All eGTP-C services (of P-GW associated with GGSN service) should be configured with **cups-enabled** CLI command.
 2. All GGSN services should be configured with **cups-enabled** CLI command.

Enabling CUPS in GTPC Service for GGSN

Use the following configuration to enable CUPS in eGTP-C service of P-GW that is associated with GGSN.

```
configure
  context context_name
    egtp-service service_name
      [ no ] cups-enabled
    end
```

Verifying CUPS in GGSN Service for SAEGW

Use the following commands to verify if CUPS is enabled for GGSN Service:

- **show configuration**
- **show configuration verbose**
- **show egtp-service { all | name *service_name* }**
- **show ggsn-service { all | name *service_name* }**

Supported Custom CLI Commands

This section describes the customer-specific CLI commands supported for GGSN in CUPS.

The following GTP-C commands are supported for GGSN in CUPS architecture.

Command	Description
gtpc support-earp	This command enables Evolved ARP (e-ARP) support for GGSN service on the Gn-Gp interface.

Command	Description
gtpc support-access-side { traffic-class { downgrade } }	This command allows Traffic Class to be downgraded by MS for Gn-Gp GGSN when Bearer Control Mode (BCM) is set as mixed.
gtpc bitrates-rounded-down-kbps	This command enables or disables rounded down kbps value of bit rate on a GTP interface. By default, this command is disabled.
gtpc map-mbr-ambr	This command maps the Maximum Bit Rate AVP received in Update PDP Context QoS message from SGSN to Aggregate Maximum Bit Rate attribute value (AMBR), AMBR is not received in Update PDP Context QoS message from SGSN. This command is applicable for Gn-Gp GGSN mode only.
gtpc update-pdp-rsp reject imsi-mismatch	This command rejects the update PDP request message if the ULI is not part of the home PLMN session.
egtp gngp-modify-bearer-rsp-with-apn-ambr	This command sends a Modify Bearer Response with APN-AMBR only for a Gn-Gp handoff.
gtpc peer-salvation	This command enables peer salvation for inactive GTP peers for an eGTP service.

The following GTPP commands are supported for GGSN in CUPS architecture.

Command	Description
gtp storage-server mode local	This command configures the storage mode as local.
gtp storage-server local file purge-processed-files [purge-interval <i>purge_interval</i>]	This command configures the time interval in minutes between successive file purges.
no gtp trigger time-limit	This command disables the time-limit trigger for CDR.
gtp attribute served-pdp-pdn-address-extension	This command enables GGSN to include an optional field "Served PDP/ PDN Address extension" in the CDR.



CHAPTER 32

GTPC Peer Record and Statistic Optimization

- [Revision History, on page 275](#)
- [Feature Description, on page 275](#)
- [How it Works, on page 275](#)
- [Limitations and Restrictions, on page 276](#)
- [Configuring the Peer Salvation Functionality, on page 276](#)
- [Monitoring and Troubleshooting, on page 278](#)

Revision History

Revision Details	Release
First introduced	21.26

Feature Description

When the Gateway receives the first GTPC message from a peer, the new peer record entry is added to the Session Manager and Demux. This new peer record entry is also propagated to all Session Managers. This process occurs even if a particular GTPC peer does not have any active sessions. This causes accumulation of inactive peer records objects, which results in excess memory usage of the Session Manager and Demux, thereby causing memory overrun of affected proclers. To address this limitation, a new keyword, **peer-salvation** has been added to the existing **gtpc** CLI in the Context Configuration mode.

How it Works

When the peer-salvation keyword is enabled at the context level, it supports the following behavior:

- When a peer goes inactive with zero number of active sessions, the timestamp is stored at that peer record object and a peer record is inserted into the inactive peer list.
- If any new session gets added to inactive peer, the timestamp is reset to zero and the peer record entry is removed from the inactive peer list to avoid salvation of the reactivated peer.

- A one-hour timeout is set per egtpmgr instance level that gets disabled when the keyword is disabled at the context level.
- Separate salvation timers run for egtpinmgr and egtpegmgr.
- By default, (when keyword is not enabled) salvation timer does not run to minimize the memory and CPU impact.

Demux Session Recover Scenario

When Demux proclat crashes or restarts, all the information related to all the inactive peers is cleared in the proclat and is not added again during the session recovery of Demux. These inactive peer records accumulated on the Demux-serving Session Managers might not get salvaged. The peer salvation functionality reconstructs the inactive peer list at the recovered Demux. The last activity timeout for the inactive peers is set to the timestamp of Demux recovery, thereby, allowing Demux to work even after Demux recovery.

Demux Inter-Chassis Session Recovery Scenario

The peer-salvation keyword can be configured on the Active and Standby chassis. When configured, it can even salvage the inactive peers accumulated on the Standby chassis.

Session Manager Session Recovery/ICSR Scenario

Configuring the peer-salvation keyword does not impact the Session Manager recovery or ICSR and vice versa.

Limitations and Restrictions

Following are the known limitations and restrictions while enabling the peer-salvation keyword:

- When the peer-salvation keyword is enabled at the context level, but not enabled at egtp-service level, then peer salvation does not occur.
- All the information (peer statistics/recovery counter and so on) of the particular peer is lost after it is salvaged.
- The context level configuration is applied to egtpinmgr and egtpegmgr separately.
- The min-peers value should be applied judiciously to ensure that the Session Manager in a fully loaded chassis does not go into warn/over state with many peer records. If the Session Manager goes into a warn/over state, then it is recommended to configure a lesser value for min-peers to ensure that the peers are salvaged.
- min-peers configuration is not considered during a new peer creation.
- Only peers with zero number of sessions are salvaged for the configured timeout value. Non-zero number of sessions is not salvaged even if there are few.

Configuring the Peer Salvation Functionality

The following section provides the configuration commands to enable or disable the feature.

gtpc peer-salvation (context configuration mode)

Use this command to enable peer salvation for inactive GTPv2 peers for EGTP services in this context. The peer-salvation keyword is introduced in the Context Configuration mode. Minimum peers and timeout values can be provided with this CLI, which is per egtpmgr (separate for egtpinmgr and egtpegmgr) and across all the egtp-services configured in that context.

To configure peer-salvation in the Context Configuration mode, enter the following commands:

```
configure
context context_name
  [ no ] gtpc peer-salvation min-peers value timeout value
end
```

Notes:

- **no**
: Disables peer salvation at the context level.
- **peer-salvation**
: Enables peer salvation for inactive GTPv2 peers for EGTP services in this context.
- **min-peers** *value*
: Configures the minimum number of accumulated GTPv2 peers across all EGTP services to start salvaging the inactive peers. The value ranges from 2000 to 12000.
- **timeout** *value*
: Configures the peer salvation timeout. The peer that is inactive for salvation time is salvaged, specified in hours. The value ranges from 1 to 48 hours.
- This command is disabled by default.

gtpc peer-salvation (eGTP service configuration mode)

Use this command to enable peer salvation for inactive GTPv2 peers for EGTP services in this context. The peer-salvation keyword is added to the existing gtpc command in eGTP Service Configuration mode. When enabled, this functionality is enabled at the specific egtp-service level. This functionality should be enabled at the context level if it is enabled at the egtp-service level. The configuration sequence is not dependent on enabling this functionality.

To configure peer-salvation in the eGTP Service Configuration mode, enter the following commands:

```
configure
context context_name
  egtp-service egtp_service_name
  [ no ] gtpc peer-salvation
end
```

Notes:

- **no**
: Disables peer salvation at the context level.

- **peer-salvation**
: Enables peer salvation for inactive GTPv2 peers for EGTP services in this context.
- This command is disabled by default.

Monitoring and Troubleshooting

This section provides information regarding show commands and/or their outputs in support of this feature.

Show Commands and/or Outputs

The output of the following CLI command has been enhanced in support of the feature.

```
gtpc peer-salvation debug-mode debug-min-peers value1 debug-timeout value2
```

show egtp-service all

The output of this command has been enhanced to include the following new field in support of the Peer Salvation functionality:

- GTPC Peer Salvation

show session subsystem debug-info

The output of this command has been enhanced to include the following new fields in support of the Peer Salvation functionality:

- Peer Salvation Stats
 - No of peer salvation requests received on sessmgr.
 - No of peer salvaged on sessmgr.

show demux-mgr statistics egtpinmgr all

The output of this command has been enhanced to include the following new fields in support of the Peer Salvation functionality:

- Peer Salvation Stats
 - No of peer salvation requests sent by demux.
 - No of peer salvaged on demux.

show demux-mgr statistics egtpegmgr all

The output of this command has been enhanced to include the following new fields in support of the Peer Salvation functionality:

- Peer Salvation Stats
 - No of peer salvation requests sent by demux
 - No of peer salvaged on demux

```
show demux-mgr statistics egtpegmgr all
```



CHAPTER 33

Gx-alias Enhancement

- [Revision History](#), on page 281
- [Feature Description](#), on page 281
- [How it Works](#), on page 281

Revision History



Note Revision history details are not provided for features introduced before release 21.24.

Revision Details	Release
First introduced	Pre 21.24

Feature Description

The Gx-alias enhancement feature is a method of installing multiple sets of predefined rules with a single Gx-alias rule name. This rule name comes from PCRF and is transparent to PCEF, where PCRF either activates or deactivates by naming each rule.

This feature is applicable for rules that are installed only on default bearer. To successfully install large number of rules, you must configure **no policy-control update-default-bearer** CLI command under the ACS configuration mode or the **no tft-notify-ue-def-bearer** CLI command under the ACS Rulebase configuration mode to implement it on a per-rulebase level. All the ruledefs, defined under the Gx-alias Group of Ruledef (GoR), must also be defined under the rulebase for it to get applied to the session.

How it Works

The CP expands the GoR for Gx-alias, allocates the PDR IDs to these installed rules, and carries the information in a vendor-specific TLV. As part of this information, the Gx-alias name with Start and End of the PDR IDs are sent to the UP. The UP, after receiving this new TLV, expands the Gx-alias into ruledefs and maps the corresponding PDR IDs in a sequence which is governed by the configuration on UP.

The functionality/behavior of the Gx-alias Enhancement feature includes:

- Before and after the configuration updates, contents of the Gx-alias GoR are exactly the same, and in the same order, on both CP and UP.
- Addition of a new ruledef in a Gx-alias GoR is applied only to new sessions. Only deletion of a ruledef from a Gx-alias GoR is handled in existing session.
- Predefined rules functionality at UP has no impact when Gx-alias is mapped to the ruledefs. That is, URR-IDs/charging is transparent to Gx-alias being used.

NOTE:

- Maximum limit of GoRs that can be configured: 64
- Maximum number of rules allowed per GoR: 512
- Maximum rules allowed per default bearer: 2048

IE Format of Gx-alias

The following table provides the IE Format and encoding information of the Gx-alias feature.

	Bits								
Octets	8	7	6	5	4	3	2	1	
1 to 2	Type = 246 (decimal)								
3 to 4	Length n [Min=7, Max=69 {5+ACSCTRL_GRP_OF_RDEFS_NAMELEN (64)}]								
5	Flags (Add/Delete GoR Rules) For example: 1 for Add, 0 for Delete rules in GoR								
6 to 7	Start PDR ID								
8 to 9	End PDR ID								
10 to n+4	Gx-alias GoR name (min size=2, max size=64)								

PFCP_IE_GX_ALIAS: IE to communicate a Gx-alias GoR name, Start and End PDR IDs, and also the operation to perform from Control Plane to User Plane during Sx Session Establishment/Modification Request message.

Call Flow

This section describes the Gx-alias enhancement call flow.

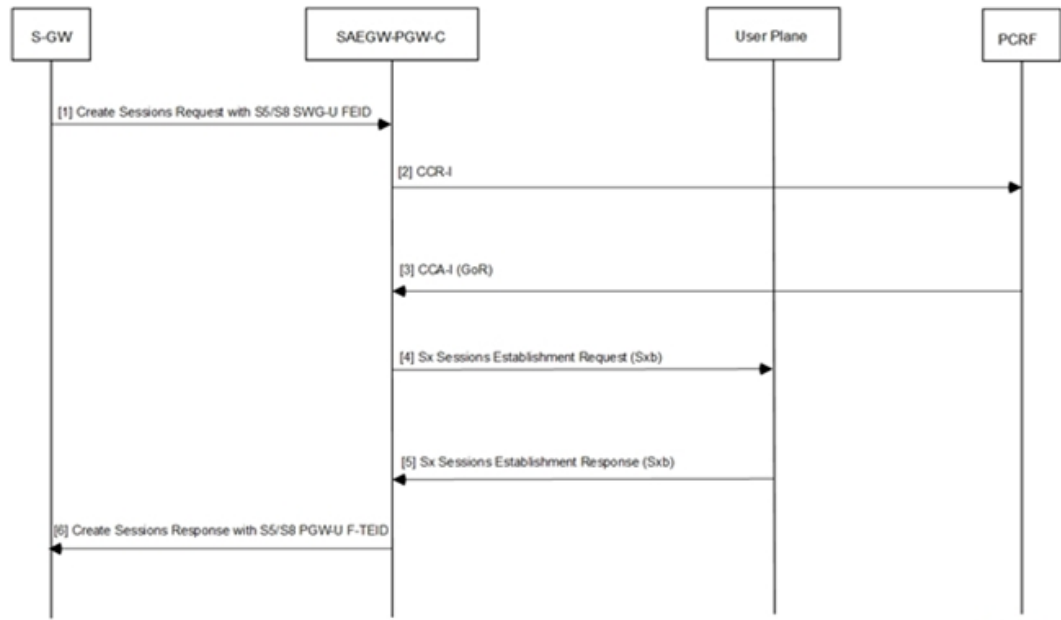

455975

Step	Description
1	S-GW sends a Create Sessions Request with S5/S8 SGW-U FEID to SAEGW-PGW-C.
2	<p>SAEGW performs Gx communication CCR-I with PCRF.</p> <p>During a Pure-P call for CUPS SAEGW, the SAEGW-PGW-C does the following:</p> <ul style="list-style-type: none"> • After Gx interaction, performs Gx communication (CCR-I and CCA-I) with PCRF. • Performs User Plane selection based on User Plane profile configured with IP pool (APN associated IP pool). • Establishes GTP-U session required for RA/RS for IPv6/IPv4v6 PDN. • Performs Sxb interaction with the selected User Plane.
3	<p>PCRF performs Gx communication CCA-I with SAEGW.</p> <p>Sx Establishment Request session contains the following information:</p> <ul style="list-style-type: none"> • GoR/GoR Action/FAR/URR information for uplinks and downlink data path: dynamic/predefined/static rules. • Also, Control Plane requests User Plane to allocate F-TEID for P-GW ingress, PDR S5/S8 PGW-U F-TEID. In Gx-alias GoRs, ruledefs must be within the same order for Control Plane and User Plane that are part of Day-0 configuration. The newly configured rules apply only to new sessions that are Cisco-specific Control Plane and User Plane node pairs.

Step	Description
4	SAEGW establishes a Sx Sessions Establishment Request (Sxb) with the User Plane. The new IE format for Gx-alias, PFCP_IE_GX_ALIAS does the following actions: <ul style="list-style-type: none"> • Communicate a Gx-alias GoR (Group-of-Ruledef) name • Start/End PDR IDs • Perform operations from the Control Plane to the User Plane during the Sx Session Establishment/Modification Request message.
5	The User Plane provides "P-GW ingress PDR S5/S8-U PGW F-TIED" information as part of Sx Session Establishment Response and establishes a Sx Sessions Establishment Response (Sxb) with SAEGW-PGW-C.
6	On receipt of the Sx Session Establishment Response, SAEGW-PGW-C sends Create Session Response towards S-GW with "S5/S8-U PGW F-TEID".

Limitation

Following are the known limitations of the feature:

- IE-handling is applicable only between Cisco-supported Control Plane-User Plane nodes. All ruledefs configured in Gx-alias GoR are bound only to the default bearer.
- To avoid exceeding the recovery time, only eight GoRs are recovered during session recovery. The maximum recommended limit of GoRs to be configured is eight (8).
- With 2048 rules, you may see an impact on scaling of sessions. The maximum recommended rules per default bearer is 1000.



CHAPTER 34

Gx AVP for UP Identification

- [Revision History](#), on page 285
- [Feature Description](#), on page 285
- [Gx Attribute Value Pair \(AVP\)](#), on page 285

Revision History

Revision Details	Release
First introduced.	21.27

Feature Description

When an overlapping IP pool is used, the Packet Data Network (PDN) IP address and the UP function ID or identity/identification are both required to uniquely identify a session at the Policy and Charging Rules Function (PCRF). The information about the UP serving the UE is received by the PCRF from the CP. This information allows PCRF to construct a new master key based on the details collected. The PCRF is able to retrieve the identification of UP serving UE and this information is sent over Gx using the diameter dynamic dictionary configuration.

During the Packet Data Network (PDN) session establishment, the System Architecture Evolution Gateway-Control Plane (SAEGW-C) is allowed to propagate the identification of UP through the Gx interface. This new AVP is then included by SAEGW-C in the Gx CCR-I and the corresponding Gx CCR-x messages wherever applicable.

Gx Attribute Value Pair (AVP)

The **UP-IP-Address** AVP (with code number 132099) is an address type and containing the UP IP address. IP address type includes both the IPv4 or IPv6 addresses. The AVP is supported in all relevant Gx CCR-x messages.

Following are the AVP details:

- AVP Name: **UP-IP-Address**

- AVP Code: 132099
- Vendor Id: 9 (Cisco)
- Mandatory Flag: Not required
- Vendor Specific Flag: Required
- AVP Type: Address
- Parent AVP: N/A
- This AVP is encoded in the CCR-I message from SAEGW-C toward PCRF.



Note The address reported in **UP-IP-Address** AVP is the UP address in **show subscribers saegw-only full all**. This is the **sx-service** associated with the **user-plane-service** in UP.



CHAPTER 35

Handling Simultaneous Gy RARs from Different DRAs with Different RGs

- [Revision History, on page 287](#)
- [Feature Description, on page 287](#)
- [How it Works, on page 287](#)
- [Configuring the Feature, on page 289](#)
- [Monitoring and Troubleshooting, on page 290](#)

Revision History

Revision Details	Release
First introduced.	21.28.m1

Feature Description

CUPS supports multiple Diameter Routing Agents (DRA) to prevent the abort of pending Credit Control Request–Update (CCR-U) requests from previous Reauthorization Requests (RAR) with a different host or peer on the Gy interface.

P-GW accepts different rating-groups (RG) from different peers by configuring the **diameter pending-ccau allow-on-rar-peer-switch** CLI command in the ACS configuration mode. This command allows you to configure the DCCA client to prevent the abort of a pending CCR-U request.

For more information on the multiple DRA support in P-GW, see the *Support for Multiple DRA over Gy Interface* chapter in the *P-GW Administration Guide*.

How it Works

This section describes how the multiple DRA feature works in CUPS.

P-GW and CUPS handle the collision scenarios differently. In legacy P-GW, each CCR-U with FORCED REAUTHORIZATION is sent to the corresponding DRAs.

In CUPS, the user plane fetches every CCR-U that is sent along with the current usage report. During collision, if more than one specific RAR is received at the same time from different DRAs for the respective rating groups, the control plane marks the Gy-URR buckets, and sends Sx Session Modification Request to the user plane. The user plane sends back the current usage reports to the control plane for the requested Gy-URR bucket in Sx Session Modification Response. If RAR is received from different DRAs, the peer switch happens. In CUPS, each CCR-U with FORCED REAUTHORIZATION for the requested rating groups is sent to the peer DRA of the latest path switched.

The following call flow illustrates how P-GW accepts both RGs from different peers.

Figure 18: Multiple DRA Call Flow in CUPS

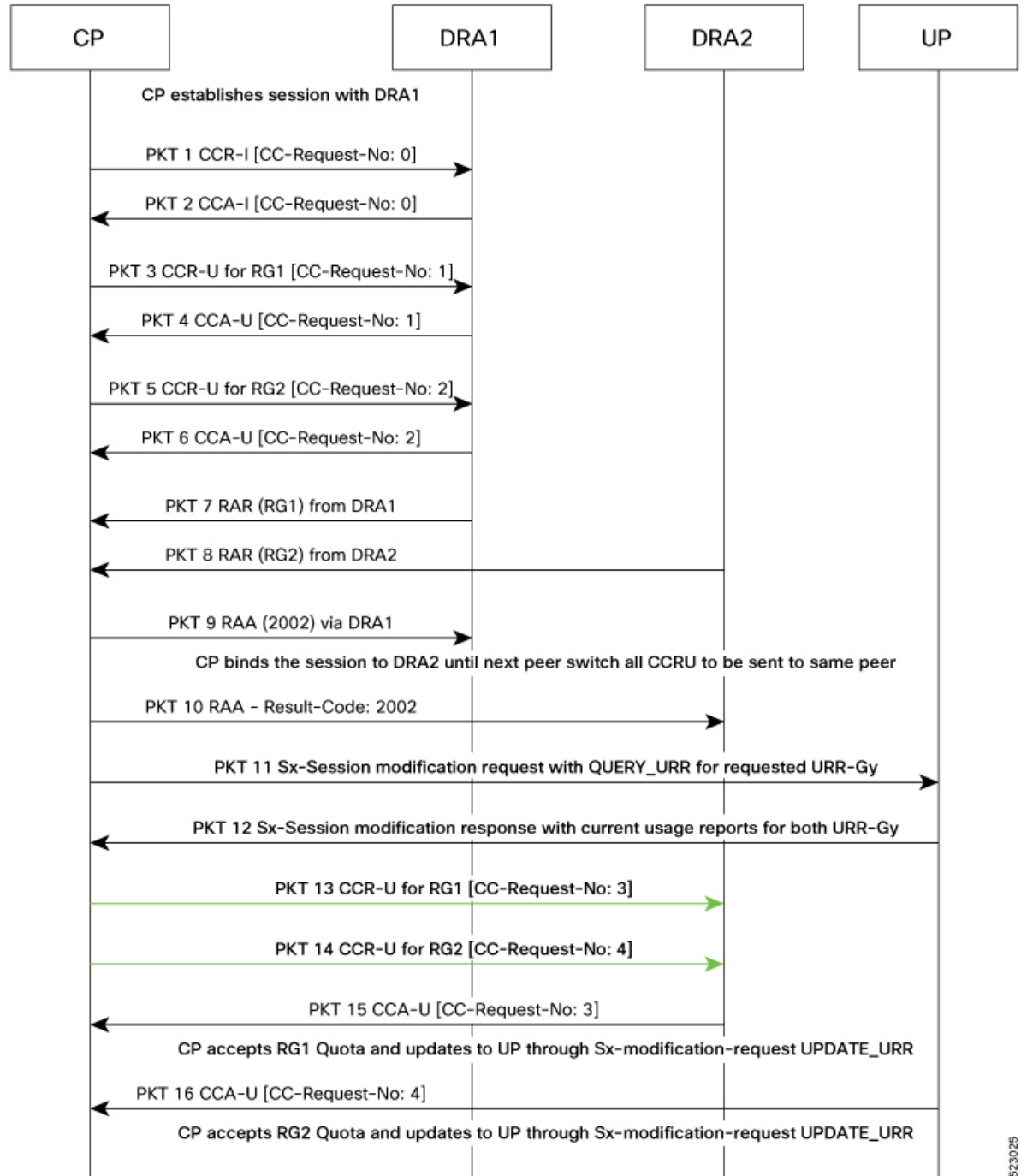

523025

Configuring the Feature

To configure the handling of multiple RAR requests involving multiple DRAs, use the following configuration:

```

configure
  context context_name
  active-charging service acs_service_name
    credit-control [ group cc_group_name ]
    diameter dictionary dictionary
      [ no ] diameter pending-ccau allow-on-rar-peer-switch
    end

```

NOTES:

- **diameter dictionary *dictionary***: Set the diameter dictionary to handle different DRAs.
For example: **diameter dictionary *dcca-custom-26***
- **diameter pending-ccau allow-on-rar-peer-switch**: Allow the DCCA client to prevent the abort of pending CCAU requests.
- **no diameter pending-ccau allow-on-rar-peer-switch**: Disable the DCCA client from preventing the abort of pending CCAU requests.

Monitoring and Troubleshooting

This section provides the monitoring and troubleshooting information for the multiple DRA feature.

Show Commands and Outputs

This section provides information regarding show commands and outputs in support of this feature.

show active-charging service all

Table 22: show active-charging service all

Field	Description
pending ccau:	
allow-on-rar-peer-switch	Displays "Enabled or "Disabled" to indicate the abort of pending CCA-U request if RAR is received from different host or peer on the Gy interface. If this feature is enabled, the functionality is applicable only to new Diameter sessions.



CHAPTER 36

Host Route Explicit Advertisement

- [Revision History, on page 291](#)
- [Feature Description, on page 291](#)
- [How it Works, on page 291](#)
- [Configuring Host Route Explicit Advertisement, on page 292](#)

Revision History

Revision Details	Release
First introduced.	21.27

Feature Description

During the SAEGW-C failover, once the UE session is established, if the IP chunk subnet route which is advertised to IP back bone is from a faulty site then it turns unusable.

How it Works

During IP pool configuration, when the IP pool is created, it is divided into chunks and stored in the pool structure along with the chunk size.

UP receives chunk allocation details from CP using the Packet Forwarding Control Protocol (PFCP) message **Sx-Association Update** request. The IP chunk subnet route that is installed by the UP is advertised over Border Gateway Protocol (BGP) along with a response.

During session establishment, IP address allocation uses **up-id** to extract the chunk which is allocated to UP and having free IP addresses. This allocated IP address is passed from the CP to the UP using the **Sx Establishment Req** message for storing in the UP database.

To support the failover of the System Architecture Evolution Gateway for Control Plane (SAEGW-C) in a remote site, once the UE session is setup, the host route is advertised instead of the route installation for IP chunk subnet during the UP chunk allocation. The same host IP route is then advertised over the remote SAEGW-C for session reestablishment from the remote UP if SAEGW-C fails.

Before the host route explicit advertisement configuration, the following processes take place:

- The value of the **explicit-route-advertise** information is communicated from the CP sxmgr to the UP sxmgr using the **Sx-Association Update** request with the IP pool content type in the IP chunk type parameter. The first bit is set for enabling support for the explicit route advertisement feature.
- The UP vpnmgr receives the value of IP chunk type from the UP sxmgr.
- The installation and advertisement of IP chunk subnet route over BGP in UP vpnmgr does not take place if the first bit of the IP chunk type is set.
- During the call establishment, the host route advertisement happens based on the IP chunk type information which is available in UP's IP chunk information. The host route advertisement is allowed once the first bit of the IP chunk type is enabled.
- CP vpnmgr maintains both the host route count per UP and the host route count in UP vpnmgr globally.
- Host routes maximum limit is 24,000. On reaching the maximum limit, the CP vpnmgr rejects the **Sx Establishment Req** request.
- During the release of a session, the host route gets deleted and the host route count is updated in the CP and UP vpnmgr.

ICSR

The IP chunk type information is updated using the checkpoint messages during the UP IP chunk details update which takes place between the UP active and standby mode.

VPNMGR Recovery

The vpnmgr local context database stores the IP chunk type information.

Limitations

Following are the known limitations of the feature:

- The maximum limit of UP host routes is 24000.
- IP pool configuration cannot be modified and must be deleted and added again with the attribute.
- During partial site failure where UPs are intact, you have to associate the failed site UP to a secondary CP. If the pool has sufficient chunks, then all UPs can serve calls from that pool. Else, only UPs which has chunk that is allocated to it serves the call.
- IPv6 support is not available for the feature.

Configuring Host Route Explicit Advertisement

Use the following CLI commands to configure the UP group specific IP pool:

```
configure
  ip pool pool_name ip_start_range ip_end_range static group-name group_name
  chunk-size chunk_size explicit-route-advertisement
end
```

NOTES:

- *pool_name*: Group specific ip pool name.
- *explicit-route-advertisement*: Parameter that is used in configuring the **host_route_explicit_advertisement** for host route explicit advertisement.

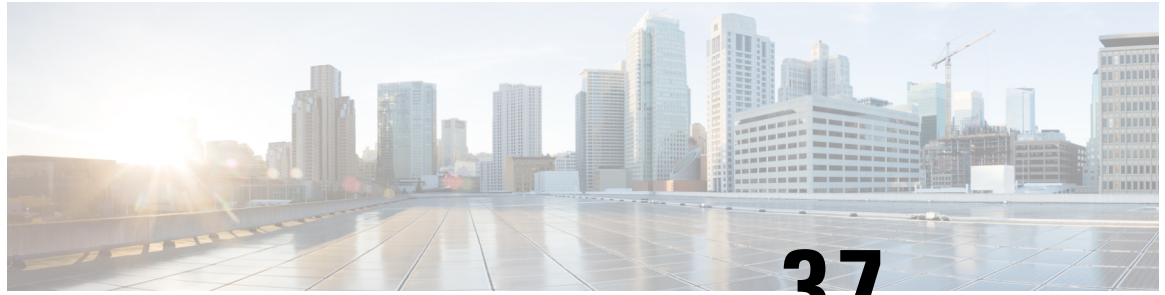

CHAPTER 37

ICSR Bulk Statistics

- [Revision History](#), on page 295
- [Feature Description](#), on page 295
- [Configuring the ICSR Bulk statistics Schema](#), on page 295
- [Bulk Statistics](#), on page 296

Revision History



Note Revision history details are not provided for features introduced before release 21.24.

Revision Details	Release
First introduced	Pre 21.24

Feature Description

This feature provides the support for ICSR Bulk Statistics schema on the User Plane.

Configuring the ICSR Bulk statistics Schema

Following is the sample configuration to configure the few of the ICSR schema on the User Plane:

```
configure
  bulkstats collection collection_detail
  bulkstats mode mode_name
  sample interval interval_value
  file file_number
  icnr schema icnr_schema format "ICSR:
switchover-number:%switchover-number% switchover-time:%switchover-time%,
switchover-reason:%switchover-reason%"
end
```

Show CLIs

Following are the show command CLIs to fetch the ICSR schema bulk statistics data.

- **Show bulk stats data** - displays criteria contained in the statistics gathering scheme for up to four files. See viewing collected bulk statistics data.
- **bulk force gather** – displays the bulkstats data.
- **show bulkstats schemas** - displays the scheme used to gather statistics including collection and transmission statistics. See verifying your configuration.
- **show bulkstats variables** - displays available bulkstat variables (%variable%) by schema type that can be incorporated into a schema format.
- **show configuration bulkstats brief** - displays the bulkstats configuration at a global scope and displays the server configuration. It does not display the schema configuration.

Bulk Statistics

Run the following CLI on User Plane to check the counters available for ICSR schema.

```
show bulkstats variables icsr
```

The following table includes the details of the ICSR counters supported on the User Plane:

Table 23: ICSR Counters applicable in UP

ICSR Counters	Description
switchover-number	Identifying number of switchovers since the last chassis rebooted.
switchover-time	Timestamp for when the switchover was initiated.
switchover-reason	Reason for switchover (manual and BGP failure and auth probe failure and so on).
switchover-duration	Amount of time it took to complete the switchover.
total-num-act-calls-swo-time	Total number of active calls at the time of the switchover.
total-num-lost-calls-swo-time	Total number of data sessions lost due to the switchover.
audit_number	Identifying number of recent audits performed since the last system reboot.
audit_chassis_state	Chassis state (active/standby) on which the audit was performed.
audit_start_time	Timestamp for when the audit was initiated.
ext-audit-sync-start-time	External audit synchronization start time on standby chassis
ready-for-switchover-time	Timestamp on standby chassis when it is ready for next switchover
audit_duration	Amount of time it took to complete the audit
audit_reason	Reason for the audit
total_audit_active_sessions	Total number of active sessions found during the audit.

ICSR Counters	Description
total_audit_new_sessions	Total number of new sessions found during the audit.
total_audit_stale_sessions	Total number of stale sessions found during the audit.
total_audit_inactive_sessions	Total number of inactive sessions found during the audit.
total_sessmgr	Total number of session manager instances on the chassis.
total_sessmgr_active_connected	Total number of session managers in the active-connected state.
total_sessmgr_standby_connected	Total number of session manager instances in the standby-connected state.
total_sessmgr_pending_connected	Total number of sessions manager instances in the pending-connected state.
total_sess_crr_count	Total number of currently existing Call Recovery Records (CRRs).
total_sess_crr_pre_installed	Total number of currently existing pre-installed CRRs.
total-num-act-sessions-swo-time	Total number of fully connected sessions found during the switchover event.
total-num-lost-sessions-swo-time	Total number of fully connected sessions lost during the switchover event
critical-flush-duration	Amount of time it took to complete the critical flush.
total-num-checkpoint-fc-flush	Total number of full checkpoints flushed during switchover
total-num-checkpoint-critical-mc-flush	Total number of critical micro checkpoints flushed during switchover
total-num-checkpoint-mc-flush	Total number of micro checkpoints flushed during switchover
total_first_fc_during_critical_flush	Total number of full checkpoints found during critical flush.
total-num-first-fc-never-sent	Total number of first full checkpoints never sent during switchover
total-num-critical-fc-not-sent	Total number of critical full checkpoints not sent during switchover
checkpoints-never-sent	Total number of SRP checkpoints that were never sent.
checkpoints-send-failed	Total number of sent SRP checkpoints that failed.



CHAPTER 38

Idle Timer for SAE-GW Sessions

- [Revision History](#), on page 299
- [Feature Description](#), on page 299
- [Limitations](#), on page 299
- [Configuring Idle Timer for SAE-GW Sessions](#), on page 300

Revision History



Note Revision history details are not provided for features introduced before release 21.24.

Revision Details	Release
First introduced	Pre 21.24

Feature Description

An Idle Timer is supported to identify and remove idle sessions that occur in the SAE-GW.

A session becomes idle in some cases where the session is removed from other network nodes, but due to a technical mishap the session could still remain on the SAE-GW leading to resources being held by these idle sessions.

The Idle Timer, once configured, removes those sessions that remain idle for longer than the configured time limit effectively utilizing the system capacity.



Important This feature is currently restricted to Pure-P and Collapsed Call.

Limitations

The Idle Timer feature does not support recovery of Idle Timer in case of redundancy events.

Configuring Idle Timer for SAE-GW Sessions

The Idle Timer is configurable at APN level.

Use the following commands to configure the idle timer for SAE-GW sessions:

```
configure
  context context_name
    apn apn_name
      timeout idle timeout_value
      no timeout idle
      default timeout idle
    end
```

- **no**: Disables the idle timer configuration.
- **default**: Configures the default value for subscriber's time out settings. The default idle timeout value is 0.
- **idle *timeout_value***: Designates the maximum duration a session can remain idle, in seconds, before system automatically terminates the session. Must be followed by number of seconds between 0 and 4294967295. Zero indicates function is disabled.



CHAPTER 39

IFTASK Hyperthreading

- [Revision History, on page 301](#)
- [Feature Description, on page 301](#)
- [How it Works, on page 301](#)
- [Configuring CPU Isolation, on page 302](#)

Revision History

Revision Details	Release
First introduced.	21.25

Feature Description

Hyperthreading uses the Parallel Computing technology to enhance the system performance on processing the packets.

How it Works

IFTASK Hyperthreading ensures that the Poll Mode Driver (PMD)/Multichannel Direct Memory Access (MCDMA) and session manager threads don't coexist on a physical core that is enabled with hyperthreading.

When you enable Hyperthreading, a single core is split into two cores. Hyperthreading ensures that the physical core and its sibling are running the same kind of process, that is, both running either PMD/MCDMA threads or session manager.

The Intel Data Plane Development Kit (DPDK)/IFTASK schedules the PMD and MCDMA threads starting from CPU core number 1 and reserves the core 0 (Master core) for servicing the IFTASK process.

On non-hyperthreaded systems, scheduling PMD and MCDMA threads on any CPU core doesn't have any impact on cache utilization and overall system performance. But, when hyperthreading is enabled, a core and its sibling are scheduled either with PMD/MCDMA or with session manager, resulting in a better system performance. To achieve this, and to maintain the CPU pair, the core numbers are scheduled from 2, instead of starting from 1. The number of IFTASK cores should always be an even number.

CPU Isolation

To enhance the system performance, the CPU which runs the PMD/MCDMA threads is isolated from the kernel. Once the CPU is isolated, the kernel stops scheduling interrupt or other kernel processes.

Limitations and Restrictions

This feature has the following limitations and restrictions in this release:

- This feature is currently supported only on VPC-DI chassis, and not qualified yet for Single Instance (VPC-SI) on Control Plane (CP).
- When you enable or disable "isolcpu", all Service Function (SF) cards are rebooted twice to take effect.
- When you modify IFTASK core configuration with "isolcpu", SF card is rebooted thrice to take effect.
- After enabling hyperthreading, and with single Non-Uniform Memory Access (NUMA) node, the number of PMD/MCDMA cores should be an even number.
- On two NUMA system, the number of PMD/MCDMA cores should be divisible by four, so that the cores are split evenly.

Configuring CPU Isolation

Use the following configuration to enable CPU isolation:

```
config
  iftask
    isolcpu-enable
  end
```

NOTES:

- **iftask isolcpu-enable**: Enables CPU isolation for all SF cards on Virtualized Packet Core - Distributed Instance (VPC-DI) chassis.
- Use the **no iftask isolcpu-enable** CLI command to disable CPU isolation.



CHAPTER 40

Indirect Forwarding Tunnel

- [Revision History](#), on page 303
- [Feature Description](#), on page 303
- [How It Works](#), on page 304
- [Configuring Indirect Forwarding Tunnel](#), on page 307
- [Monitoring and Troubleshooting](#), on page 308

Revision History



Note Revision history details are not provided for features introduced before release 21.24.

Revision Details	Release
First introduced	Pre 21.24

Feature Description

SAEGW supports Indirect Forwarding Tunnel (IDFT) procedures for creation and deletion, which are applicable for Pure-S and Collapsed calls with multi-PDN and multi-bearers. This feature is applicable for IDFT support with and without S-GW relocation and collision scenarios.



Note The IDFT in CUPS is a CLI-controlled feature. By default, the IDFT feature in CUPS is disabled.

How It Works

Call Flow

The following call flow illustrates, at a high-level, the IDFT support without S-GW Relocation.

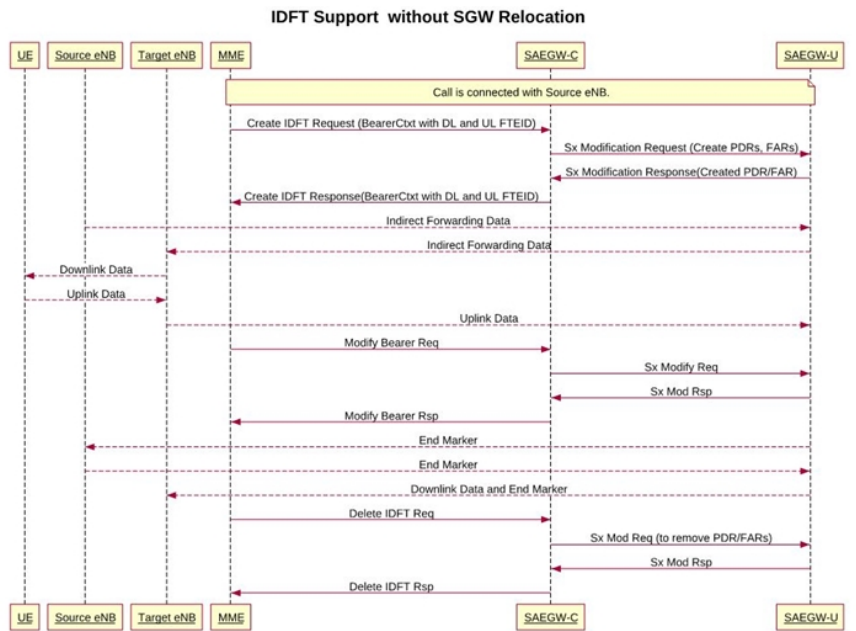

437403

The following call flow illustrates the IDFT support with S-GW Relocation.

Figure 19: IDFT Support with S-GW Relocation

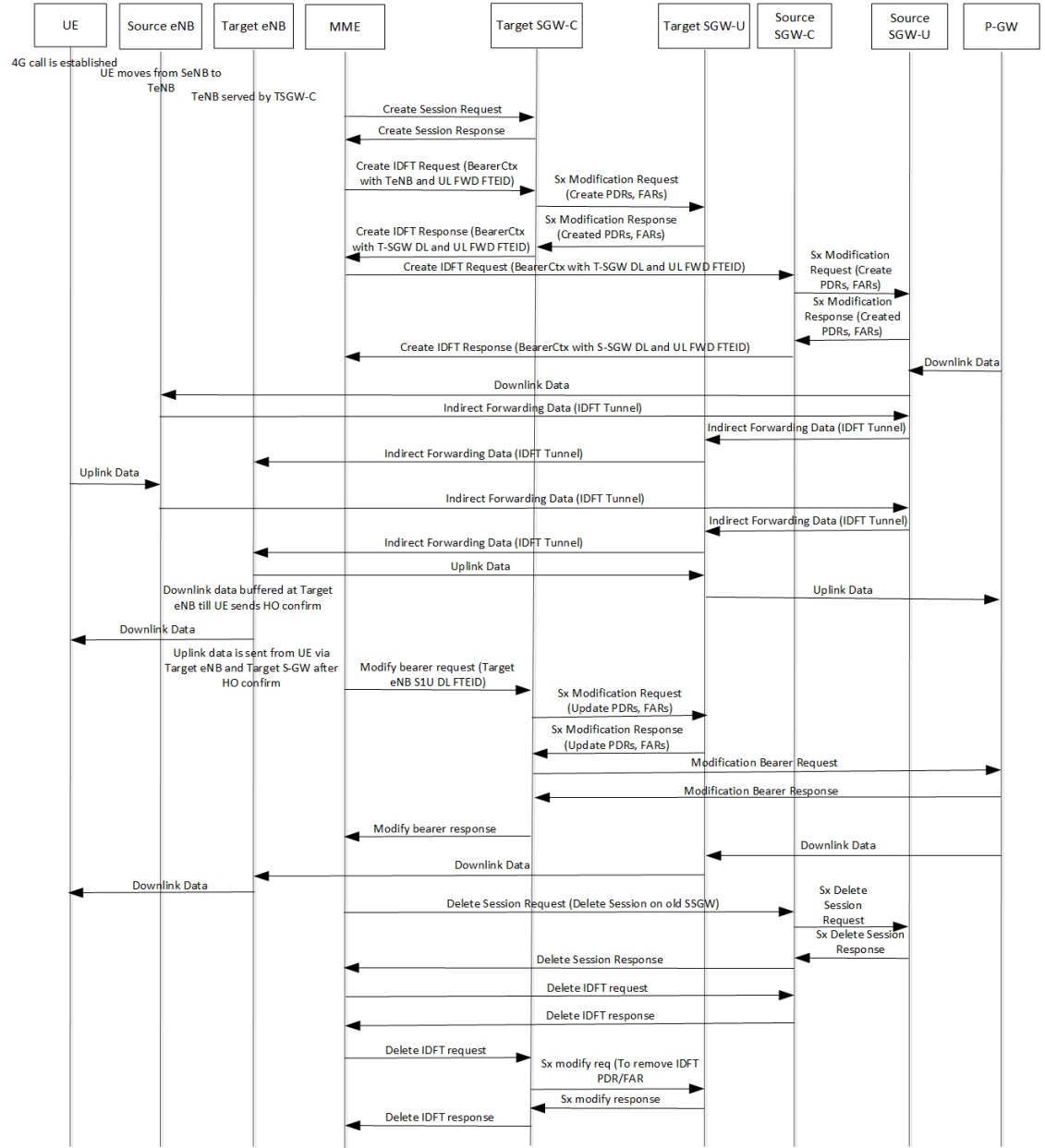

455686

The above call flow describes the IDFT tunnels establishment and deletion with S-GW relocation and without MME change.

If IDFT tunnels are not deleted by MME, then S-GW initiates the local delete of IDFT tunnels.

This feature supports the following scenarios for the Pure-S and Collapse calls:

- S-GW relocation with same MME
- S-GW relocation with same MME and different eNodeB
- S-GW relocation with different MME

- S1-based eNodeB Handoff
- EUTRAN to UTRAN Handoff



Note S4 interface is not supported in CUPS. Hence any EUTRAN to UTRAN handoffs (and vice-versa) involving S4 interface is also not supported.

- EUTRAN to UTRAN Handoff with S-GW relocation
- UTRAN to EUTRAN Handoff
- UTRAN to EUTRAN Handoff with S-GW relocation
- Sx transaction timeout during IDFT setup or removal
- Pending Sx transaction (event from PCRF or OCS) and IDFT request comes in
- Create Bearer Request (CBR) during Active IDFT
- Update Bearer Request (UBR) during Active IDFT
- Delete Bearer Request (DBR) during Active IDFT
- Modify Bearer Request (MBR) behavior on other PDN during Active IDFT
- Source MME path failure
- Target MME path failure
- MME path failure with NTSR enabled
- eGTP-C S5 path failure
- eGTP-C S5 path failure with P-GW restart notification enabled
- Sx path failure (clean IDFT and calls)
- Abort session (clear sub all, local abort, and so on.)
- CBR, UBR on other PDN during Active IDFT
- DBR on other PDN/bearer during Active IDFT
- S1-u path failure for target eNodeB
- S-GW path failure for target S-GW
- S1-u error indication on the default bearer while Active IDFT
- S1-u error indication on the dedicated bearer while Active IDFT
- S1-u error indication from the target S-GW to source S-GW bearer
- S1-u error indication from the target eNodeB to target S-GW bearer

Supported Functionality

The IDFT feature supports the following functionality:

- Create IDFT request for Collapsed, Pure-S, combination of Collapsed and Pure-S multi-PDN calls with multiple bearers.
- Data transfer on downlink and uplink IDFT bearers.
- Deletion of IDFT request from MME. Also, timer-based deletion of IDFT bearer after expiration of a default value of 100 seconds, if the MME does not send an IDFT request for deletion.
- Deletion of IDFT PDN, including Clear/Delete subscribers from MME/P-GW, when normal PDN goes down.
- Sx-Path failure handling in case of Pure-S and collapsed calls during IDFT Active/ IDFT Create Sx-Pending state.
- Message interaction and collision during IDFT PDN establishment or deletion with any other procedure.
- S11/S5 and Sx Path Failure Handling on non-IDFT PDN is now supported when IDFT PDN is Active.



Important Transport GTP-U address capability is assumed to be same across eNodeB and S-GW.

Configuring Indirect Forwarding Tunnel

This section describes the CLI commands available in support of IDFT feature.

Enabling Indirect Forwarding Tunnel Feature

On Control Plane, use the following CLI commands to enable or disable the IDFT feature.

```
configure
context context_name
  sgw-service service_name
    [ default | no ] egtp idft-support
  end
```

NOTES:

- **idft-support**: Enables/Disables the IDFT feature in CUPS.
- By default, the IDFT feature is disabled and this CLI command is applicable on run-time change.

Verifying the Indirect Forwarding Tunnel Feature

show sgw-service name <service_name>

On Control Plane, the output of this CLI command has been enhanced to display if the IDFT feature is enabled or disabled.

- IDFT-Feature Support for CUPS : Enabled/Disabled

Monitoring and Troubleshooting

This section provides information regarding the CLI commands available in support of monitoring and troubleshooting the feature.

Show Commands Input and/or Outputs

This section provides information regarding show commands and their outputs in support of the feature.

show subscribers saegw-only full all

On Control Plane, use this command to see the IDFT Local and Remote TEID data. The following is a sample output:

```
Indirect Fwding   : Active
DL fwd local  addr: 209.165.200.228           DL fwd remote  addr: 209.165.200.226

DL fwd local  teid: [0x80028004]             DL fwd remote  teid: [0x2002d2e5]
UL fwd local  addr: 209.165.200.228           UL fwd remote  addr: 209.165.200.226

UL fwd local  teid: [0x8002a004]             UL fwd remote  teid: [0x20042bca]
```

show subscribers user-plane-only callid <call-id> pdr all

On User Plane, use this command to see the PDR or FAR created for IDFT. The following is a sample output:



Important IDFT PDRs will have ACCESS as the source and destination interface type.

```
+-----Source Interface:      (C) - Core          (A) - Access
|-----Type                  (P) - CP-function   (.) - Unknown
|
|+-----Destination Interface: (C) - Core          (A) - Access
||-----Type                 (P) - CP-function   (.) - Unknown
||
||
||+-----Rule-Type:          (S) - Static        (P) - Predefined
|||-----Type               (D) - Dynamic        (.) - Unknown
|||
|||
vvv  PDR-ID      Associated FAR-ID      Associated URR-ID(s)      Associated QER-ID(s)
---  -
CAS  0x0001     0x8001                  n/a                       0x80000001
CAS  0x0002     0x8002                  n/a                       0x80000001
```

```

ACD 0x0003      0x0003      0x00000007      0x00000002
      n/a      0x80000003
CAD 0x0004      0x0004      0x00000007      0x00000002
      n/a      0x80000003
CAD 0x0005      0x0005      0x00000000      n/a
ACD 0x0006      0x0006      0x00000000      n/a
CAD 0x0007      0x0007      0x00000000      n/a
ACD 0x0008      0x0008      0x00000000      n/a
AAD 0x0009      0x0009      0x00000000      n/a
AAD 0x000A      0x000A      0x00000000      n/a
AAD 0x000B      0x000B      0x00000000      n/a
AAD 0x000C      0x000C      0x00000000      n/a
    
```

Total subscribers matching specified criteria: 1

show subscribers user-plane-only full all



Important Data statistics on IDFT PDRs are captured in the same way as existing PDR statistics. However, it is captured with a limitation – Statistics for DL and UL IDFT will be incremented in Pkts-Down and Bytes-Down category.

The following is sample output:

```

Static & Predef Rule Match stats:
Rule Name      Pkts-Down  Bytes-Down  Pkts-Up    Bytes-Up    Hits      Match-Bypassed
FP-Down (Pkts/Bytes)  FP-Up (Pkts/Bytes)
-----
catchall      0          0          3          1368        3          0
      0/0          0/0
Dynamic Rule Match stats:
PDR Id      Pkts-Down  Bytes-Down  Pkts-Up    Bytes-Up    Hits      Match-Bypassed
FP-Down (Pkts/Bytes)  FP-Up (Pkts/Bytes)
-----
0x0004      2          856         0          0          2          0          0/0
      0/0
0x000b      2          856         0          0          2          0          0/0
      0/0
0x000c      2          168         0          0          2          0          0/0
      0/0
    
```

show subscribers user-plane-only full all



CHAPTER 41

IP Pool Management

This chapter includes the following topics:

- [Revision History](#), on page 311
- [Feature Description](#), on page 311
- [How It Works](#), on page 312
- [Configuring IP Pool Management](#), on page 319
- [Monitoring and Troubleshooting](#), on page 322

Revision History



Note Revision history details are not provided for features introduced before release 21.24.

Revision Details	Release
Support of maximum chunk-size value for IPv6 pools is increased to 65536.	21.27
Support of UP selection based on the availability of IP pool chunks.	21.26
With this release, the VPN limitation of 100 UPs per context has been removed.	21.25
First introduced	Pre 21.24

Feature Description

When the IP Pool is unused for a large part, it is not an efficient way of utilizing the resources. The User Plane (UP), which are short of IP resources, can benefit if the unused resources are available to them in a dynamic way.

In the CUPS architecture, there is a centralized Control Plane (CP), large number of UPs, and an automatic and efficient way of managing IP Pool across UPs for the following deployments:

- Co-Located CUPS

- Remote CUPS

This feature enables the configuration of maximum chunk size value of 65536 for IPv6 pools for minimum IP subnet /48 size for dynamic discovery and IP pool assignment to UP.

How It Works

In CUPS architecture, the PDN/IP context at CP distributes the IP chunk resources among multiple registered UPs in a dynamic way. Following sections describes the overall solution.

Handling UP De-Registration

UP de-registration is triggered in the following scenarios:

- Graceful de-registration from UP—In this scenario, Control-Plane-Group association is removed with User-Plane-Service CLI. The IP addresses are released at sessmgr level on CP.
- UP connection failure from CP—This scenario occurs either because of miss of heartbeat from UP to CP, or because UP restarts and CP is communicated about it. When UP restarts, it implies that the reception of a new Restart-Counter at CP of the specified UP.

After the UP de-registration is triggered, the VPNMGR task on CP validates the identity and address of UP with the information available in the VPNMGR database. In case of mismatch, VPNMGR shows the failure message. In case of match, the validation is successful. On successful validation, VPNMGR takes all the assigned and unassigned chunks from both IPv4 and IPv6 pools from the specified UP.

Whether the UP has some used or all unused IPs, VPNMGR starts a 2-minutes timer before carrying out forceful de-registration of the UP. During forceful de-registration, all IP addresses are deleted from VPNMGR database locally, session entries are removed, and all the chunks are placed to the main address pools at CP.

Hold Timer

Hold Timer is configured per pool for IPv4 dynamic pools. Static pools and IPv6 pools aren't considered. If Hold Timer isn't configured, an IP address moves from Free to Used state when allocated, and back to Free state when the session is released. With the Hold Timer configured in the pool, a released IP address is moved to Hold state. For the configured Hold Timer duration, the IP address is kept in Hold state and can be reused when the same subscriber attaches again. Since it's in Hold state, the IP address isn't assigned to any other subscriber. After the Hold Timer expiry, the IP address moves to Release state and it's reused when all the free IP addresses are exhausted.

In case of UP deregistration, all IP addresses in Hold state are moved to Free state since the UP details (UP ID and the memory that holds details of UP) aren't preserved at the CP. This might result in the IP address being reused for a different subscriber. Also, VPNMGR recovery and ICSR are supported for Hold addresses.

Address State Change

Following call flow describes the address state change with Hold Timer configured.

Figure 20: Address State Change with Hold Timer

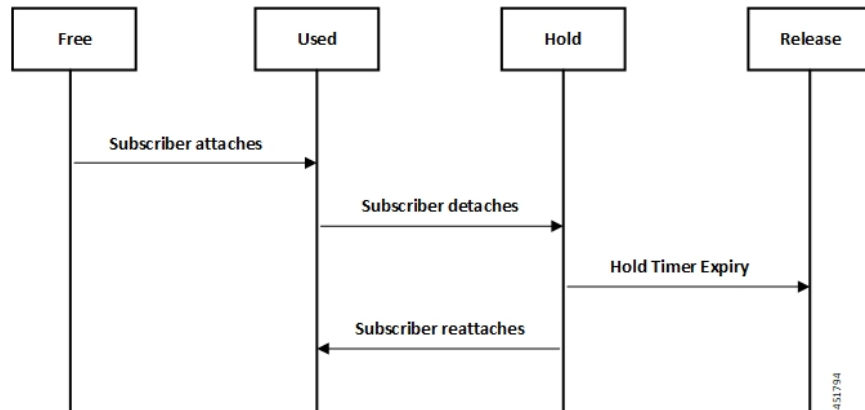

Following call flow describes the address state change without Hold Timer configuration.

Figure 21: Address State Change without Hold Timer

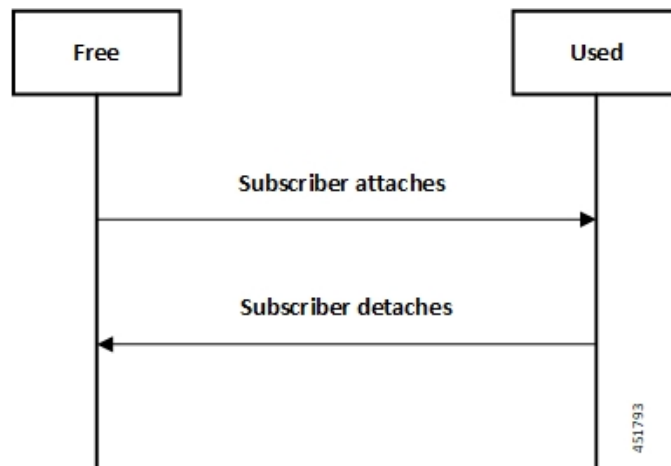

Configuring Hold Timer

Use the following configuration to enable Hold Timer feature in CUPS.

```

configure
  context context_name
    ip pool pool_name address-hold-timer seconds
  end

```

NOTES:

- *pool_name*: Specifies the logical name of the IP address pool. *pool_name* must be an alphanumeric string of 1 through 31 characters.
- When the feature is enabled, and an active subscriber is disconnected, the IP address is held or considered still in use, and isn't returned to the free state until the address-hold-timer expires. This enables subscribers who reconnect within the length of time specified (in seconds) to obtain the same IP address from the IP pool. *seconds* is the time in seconds and must be an integer from 0 through 31556926.

Use the **show ip pool address pool-name pool_name** CLI command to check the status of all IP addresses in a pool. It also shows the remaining hold time for the held addresses.

IP Pools per Context

You can configure 600 IP pools per UP group in a single context at CP. Also, 2000 IPv4 and 256 IPv6 pools can be configured per context in CP which can be distributed among various UP groups with upper limit of 600 pools per UP. The functionality includes:

- UP group can have a maximum of 600 IP pools for all possible combinations of pool type.
- Pools can be either static, dynamic, or combination of both.
- Pools can be all IPv4, IPv6, or combination of both.
- Out of 600, a UP group can have a maximum of 256 IPv6 pool (context level limitation that is same as ASR5500). All 600 pools can be IPv4.
- If more than 600 IP pools are configured in a UP group, then it can't be determined as to which 600 pool/pool chunks will be allocated to a UP.
- The CP maintains count of routes that are installed at UP. If it exceeds 6000 pool routes (context level limitation that is same as ASR5500), then no new chunk is allocated to UP even if it reaches the threshold for overuse. Similarly, if new IP pool is dynamically allocated and 6000 pool routes are already installed, then no new chunk is allocated from that pool even if pool count is less than 600 for that UP.

As part of this feature, the dynamic IPv4 and IPv6 pool count is replaced with total IPv4 and IPv6 pool count in the **show ip user-plane verbose** CLI command. Also, the output of the CLI command is enhanced to display Total Pool Kernel Routes and Max Pool Kernel Routes fields.

IP Resource Management

In CUPS architecture, the CP has all the IP Pool configurations in PDN/IP context. In compliance with 3GPP standards, the UP registers with CP by Sx Association Request/Response procedure.

During the registration process, the CP finds out all the APNs which are being served by the particular UP, and the associated Pool configuration in each APN. The CP allocates some of the IP chunk resources to a particular UP and sends over the Sx Association Update Request/Response procedure. This information is sent to PDN/IP context instance at UP.

After UP registration is successful, the PDN/IP instance initiates sending of IP chunk resource information to the UP from the Pool. This IP chunk resource information is sent to the UP on Proprietary/Custom IE on Sx Association Update Request/Response message. The PDN/IP instance at UP announces the BGP routes, on per chunk basis, which is received from the CP.

Each UP, which is registered with the CP, is identified using "Peer Id" and the Node ID.

IP Resource Replenishment/Withdrawal Procedure

For efficient utilization of IP resources, the CP allocates IP resources to UP on need basis. And so, it supports replenishment and withdrawal procedures for IP chunk resources.

Based on the threshold logic in CP, it monitors the usage of IP resources in each UP on pool-level basis. If the overall IP chunk usage of the UP crosses certain threshold, the CP sends additional IP chunk resources to the UP.

If certain IP chunks in the UP are not utilised, and idle for certain duration, the CP withdraws those IP chunk resources from respective UPs. For details, see *Configuring Percentage of Chunks Per Pool* section.

No-chunk-pool for One UP per UP Group

Feature Description

For static IP address allocation, the SessMgr requests for specific IP address. The VPNMgr searches for that specific IP address. If the chunk is already allocated to a particular UP, then the VPNMgr allocates that address and responds to the UP which serves the call. For static IPv4v6 call, the requested IPv4 and IPv6 address might belong to different UPs and therefore, success of IPv4v6 can't be guaranteed unless there's only one UP per UP Group. So, for successful static IPv4v6 call, only one UP per UP group can be configured. For one UP per UP Group use case, pool chunking isn't recommended as only one UP uses that pool, and the entire pool can be allocated to the UP rather than in chunks. Also, there are certain use cases to contain one APN to one UP. To support both these use cases, an option to not chunk the pool in CUPS architecture is introduced.

Without the no-chunk-pool functionality, if number of usable addresses are less than the chunk size, then minimum of two chunks were configured.

With no-chunk-pool functionality, a pool can be configured without being chunked. The entire pool is allocated to the UP that is first to request for the pool.



Note The no-chunk-pool functionality is recommended only for a setup with one UP per UP Group. It's not recommended for multi-UP per UP Group.

How it Works

The no-chunk-pool functionality includes:

- When a pool is configured as no-chunk-pool, then pool itself is considered as a chunk and the entire pool is allocated to the UP that is first to request for the pool.
- No-chunk-pool can be public, private, or static.
- No-chunk-pool can be configured within VRF.
- For multi-UP per UP Group, the entire dynamic no-chunk-pool is allocated to the UP that is first to do Sx-association.
- For multi-UP per UP Group, the static no-chunk-pool is allocated in round-robin algorithm among currently servicing UP.
- For multi-UP per UP Group, the dynamically added new pool can get allocated to any UP in UP Group and can't be deterministically known.

Configuring No-chunk-pool

Use the following configuration to enable no-chunk-pool functionality.

```
configure
  context context_name
    cups enable
      ip pool pool_name ip_address/subnet_mask no-chunk-pool
      ipv6 pool pool_name prefix ip_address/length no-chunk-pool
    exit
```

The no-chunk-pool can be identified from the output of the following CLI commands if the "total-chunks" field displays 1 (one) for that particular pool.

- **show ip pool-chunks pool-all**
- **show ipv6 pool-chunks pool-all**

Static IP Pool Management

In CUPS architecture, the strategy to manage static IP pools differs from dynamic pool management. Static IP pools are broken down into "static-chunks" similar to how dynamic pools are chunked. However, these static chunks are not distributed to the UPs and remain at the CP until a UE requests for the first static address in a certain Static-IP-Chunk during session creation.

The CP selects the UP using the round-robin algorithm and the entire Static-IP-Chunk, to which the requested static address belongs, is assigned to the selected UP. Therefore, whenever any UE requests static addresses (IPv4 or IPv6) from that chunk, the UE is assigned that UP.



Note

- Within dynamic pools, "allow static" is not supported.
- IPv4v6 static PDP is not supported with multiple UPs in a UP Group.
- For the static IPv4v6 PDNs to be successful, both IPv4 and IPv6 addresses must be on the same UP. Only way to ensure this is to have a single UP in the UP group.
- For the multi-PDNs on same APN to be successful, with one PDN as static and the other as dynamic, both addresses must be on same UP. Only way to ensure this is to have a single UP in the UP group.
- In case of static IP pool, address is already decided by UE and so, the benefit of UP selection does not remain.

UP Selection

In CUPS architecture, during the establishment of sessions, UP selection happens among the registered UP. There are various ways to select UP. In earlier releases, Round-Robin Algorithm based UP selection was supported. Currently, least connection User Plane selection algorithm is supported.

UP Selection based on IP Pool Chunk Availability

Prior to 21.26 release, the CP selects an UP based on least session usage or Round-Robin algorithm. If chunks are exhausted in a selected UP, it results in rejection of Session Establishment request by the CP until new IP pools are added for the impacted APNs. This result in wastage of IP resources in an UP, which still has some chunks with free IP addresses.

In 21.26 and later releases, this feature is enhanced to allow UP selection based on the availability of IP pool chunks. When chunks are exhausted in some UPs, and if the CP receives an attach request, the CP selects randomly any UP that has IP addresses available. Also, it ignores any other UP selection algorithm that is configured.

Limitations

- UP selection for Pure-S calls isn't supported.
- Only non-DNS based UP selection is considered for IP address-based validation.
- UP selection is overridden if the selected UP has no IP address to allocate for the session.
- During Sx association, if one of the contexts don't have sufficient chunks for all UPs, then only UPs which get chunks are maintained in VPN.
- As the VPN overrides UP selection when chunks aren't available in certain UPs, you must follow proper IP pool planning guidelines to minimize uneven load distribution across UPs.

For IP pool planning guidelines, see [IP Pool Planning Guidelines, on page 867](#).

Supported Functionality

The following functionalities are supported as part of the IP Pool Management feature.

- IPv4, IPv6 Public, and private pool-based IP address allocation.
- IPv4 static type address allocation.
- Session Manager recovery and VPN Manager recovery for active calls types.
- CP to CP Interchassis Session Recovery (ICSR) support.
- Hold-timer for IPv4 pools.
- Busy-out (basic functionality) for IPv4 and IPv6 pools.

Limitations

Following are the known limitations and restrictions of this feature for this release:

- The “allow-static” type pool configuration isn't supported.
- Configure the **cups enabled** CLI before you add a pool in IP context to enable IP Pool Management functionality in CUPS mode.
- IPv4v6 static PDP isn't supported with multiple UPs in a UP Group.
- The output of the following CLI commands displays all pools with maximum of 2048 chunks per pool:

- **show ipv6 pool-chunks up-id** *up_id*
 - **show ipv6 pool-chunks pool-name** *ipv6_pool_name*
 - **show ip pool-chunks up-id** *up_id*
 - **show ip pool-chunks pool-name** *ipv4_pool_name*
- Following are not supported in the CUPS architecture:
 - IPv6 – address hold timer is not supported.
 - PDN v4v6 – address hold timer is not supported.
 - Upon UE reattach, CP needs to select the same UP session (as IP address is already advertised by that UP in the earlier session). Hence there is no UP load based selection or location based UP Selection possible.
 - Hold timer value of 0 is not supported.
 - Recovery of Hold timer is supported for up to 1000 address per session manager.
 - Reload chassis results in the standby chassis losing the hold timer information.
 - Any change to the Hold timer value also requires a Sx re-establishment like it happens for any other pool configuration.

Pool System Limits

Currently CP DI-Large model supports the scaling numbers for parameters that are as listed in the table below. These limits remain constant irrespective of the chunk size value used and are the maximum limit value of any given parameter. The limits of the parameter which have reached their maximum value restricted the subsequent parameter's upper limit value.



Note Small and medium model will have lower limits than the rest.

Parameters	Limits
IPv4 pools per context	2000
IPv6 pools per context	256
IP pools per chassis	5000 (including both v4 and v6)
Dynamic pool addresses	16 Million per context 32 Million per chassis
Static pool addresses	32 Million per context 96 Million per chassis
Number of VRFs	300 per context 2048 per chassis

Max IP Pool size	512k
Max IPv6 Pool size	1 Million

Implications of chunk size on UP group:

The pool is the basic unit for chunk allocation and all UPs are allocated chunks from the relevant pools. Maximum UPs which can get chunks with chunk size value of 65536 are $1 \text{ million} / 65536 = 16$. Due to which only 16 UPs are supported in each UP group for the chunk size value being 65536.

Implications of chunk size on APN:

For a single UP group used in APN configuration, the limits are same as the UP group limit values.

For multiple UP groups used in APN configuration, refer to the *Multiple UP Groups with Group Specific IP Pool* chapter. The maximum UP groups of 16 UPs that are supported are 16 million addresses per context or 1 million address pool allowing a total of 16 UP groups of 16 UP APN.

Due to the exhaustion of all pool configuration in the v6 pool, the rest of the APN operating in the same VPN context use the same IPv6 pool. The 16 UP groups of 16 UPs is based on the assumption that there are no IPv4 addresses as otherwise the limit is lower than expected. As 32 million dynamic addresses are supported by the system, only 2 SGI contexts are allowed.

Configuring IP Pool Management

This section provides information about the CLI commands available in support of this feature.



Important

- In an earlier release, User Plane profile configuration was required for S-GW and P-GW. With this release, User Plane profile configuration is no longer required in S-GW and P-GW for UP selection. Also, it is not required to be associated with IP pool configuration.
- Same PDN context should be present at both CP and UP.
- IP context name, which is specified in APN configuration, should be same for both CP and UP.

For guidelines around planning IP Pool and User Plane grouping in your network, contact your Cisco Account representative.

At Control Plane

Enabling IP Context for IP Pool Management

Use the following CLI commands to enable IP context for IP Pool management.

```
configure
  context context_name
    cups enable
  end
```

Configuring Custom Threshold Timer



Important In 21.9 (mid-July) and later releases, the **cups chunk-allocate-timer** *allocate_timer_seconds* **chunk-release-timer** *release_timer_seconds* CLI command is deprecated, and replaced by **cups chunk-threshold-timer** *threshold_timer_seconds* and **cups min-chunks-threshold-per-pool** *threshold_percent* CLI commands.

There is a threshold timer for chunk redistribution among UPs. By default, for sending chunk into an over utilized UP, check is carried out every 60 seconds, and for removing chunk from an underutilized UP, check is carried out every 300 seconds. For custom threshold timer, use the following CLI commands:

```
configure
  context context_name
    cups chunk-allocate-timer allocate_timer_seconds chunk-release-timer
    release_timer_seconds
  end
```

NOTES:

- This is an optional configuration. If not configured, then by default the allocate threshold is 60 seconds and the release threshold is 300 seconds.
- Use the **default cups chunk-allocate-timer chunk-release-timer** CLI command to revert back the chunk-allocation and chunk-release timer to 60 and 300 respectively.
- If the release timer is configured to be less than the allocate timer, then it is overwritten with the value that equals to the allocate timer.

Configuring Chunk Threshold Timer

Use the following CLI commands to configure CUPS IP pool chunk threshold timer for a context.

```
configure
  context context_name
    cups chunk-threshold-timer threshold_timer_seconds
  end
```

NOTES:

- *threshold_timer_seconds*: Specifies the chunk threshold timer value in seconds, integer 30 to 300. Default = 60 seconds.
- Use the **default cups chunk-threshold-timer** CLI command to set the default value of 60 seconds.
- In releases prior to 21.9 (mid-July), allocation of new chunks to UP and release of chunks from underutilized UP use to occur based on allocation and release timers, respectively. With 21.9 (mid-July) and later releases, only single threshold timer exists, based on which the allocation and release of chunks occur periodically.

Configuring Percentage of Chunks Per Pool

Use the following CLI commands to configure minimum percentage of chunks per pool in a context.

```

configure
  context context_name
    cups min-chunks-threshold-per-pool threshold_percent
  end

```

NOTES:

- *threshold_percent*: Specifies the minimum chunks in percentage of 0 to 50. Default = 10.
- Use the **default cups min-chunks-threshold-per-pool** CLI command to set the default value of 10 percent.
- Chunks are released periodically only when free chunks with particular pools, at CP, are less than the percentage configured with this CLI command.
 - When minimum chunks equals to, or falls below, the configured percentage, a check is done to ascertain if there is any UP that has less than 50% utilization and has more than 2 free chunks. If there is, then one is taken back from each underutilized UP from that particular pool.
- Warning log is generated for: periodicity = chunk-threshold-timer; till minimum chunks in CP VPNmgr are restored.
- UP lockdown period on registration: For first five (5) minutes of a UP registration, no chunks are taken back from that UP and sent to another UP even if other UPs are in need of chunks.

Configuring Chunk-size Value

Use this CLI command to specify the size of the chunk for the particular IP pool during pool creation.

```

configure
  context context_name
    ip pool pool_name prefix mask chunk-size chunk_size_value
  end

```

NOTES:

- Chunk-size configuration happens only during the configuration of IP pool for the first time along with prefix or mask.
- Chunk-size value must be in powers of 2 and range from 16 through 65536.
- Default Value: 1024

At User Plane

For IP context in UP, there is no requirement for IP Pool configuration, or to use the **cups enabled** CLI command.

Configuring User Planes for a System

Use the following CLI commands to configure maximum number of User Planes expected to be functional in a system.

```

configure
  context context_name
    cups max-user-planes value
  end

```

NOTES:

- In releases prior to 21.25:
 - cups max-user-planes value:** The default value is 10.
 - The maximum number of user-planes supported in a context and UP Group is 100.
- In 21.25 and later releases:
 - cups max-user-planes value:** The value is in the range of 1-1000. The default value is 10.
 - The maximum number of user-planes supported in a context is increased to 1000.
 - This refers to the VPNMGR limits and not the actual number of user-planes that are supported. The actual number of user-planes supported in the system is determined by Sx.
 - Use this CLI command to tune the chunks that were initially allocated on Sx-association. It can't be used to restrict the addition of new UPs into a system.
- Use the **default cups max-user-planes** CLI command to revert back the maximum user-planes value to 10.

Monitoring and Troubleshooting

This section provides information regarding monitoring and troubleshooting the feature.

Show Command(s) and/or Outputs

This section provides information regarding show commands and/or their outputs in support of this feature at CP.

show ip pool-chunks pool-name <pool-name>

The output of this command displays all the chunks in the specified IPv4 pool.

- chunk-id
- pool-id
- up-id
- total-addr
- free-addr
- used-addr
- hold-addr
- release-addr

- busyout-free
- busyout-used

show ip pool-chunks pool all

The output of this command displays the IPv4 pool chunks that are allocated to all the User Planes.

- chunk-id
- pool-id
- up-id
- total-addr
- free-addr
- used-addr
- hold-addr
- release-addr
- busyout-free
- busyout-used



Note The above fields are also displayed for the **show ipv6 pool-chunks pool all** CLI command except for the "hold-addr" and "release-addr" fields.

show ip pool-chunks up-id <up_id> user-plane-group name <grp-name>

The output of this command displays all the IPv4 chunks that are allocated to a specific User Plane.

- chunk-id
- pool-id
- up-id
- total-addr
- free-addr
- used-addr
- hold-addr
- release-addr
- busyout-free
- busyout-used

show ip user-plane chunks

The output of this command displays IPv4 chunks allocated to each User Plane.

- up-id
- total-chunks
- free-chunks
- used-chunks
- full-chunks



Note The above fields are also displayed for the **show ipv6 user-plane chunks** CLI command.

show ip user-plane prefixes

The output of this command displays IPv4 prefixes allocated to each User Plane.

- up-id
- Total
- Free
- Used
- Hold
- Release
- Busyout-Free
- Busyout-Used



Note The above fields are also displayed for the **show ipv6 user-plane prefixes** CLI command.

show ip user-plane verbose

The output of this command displays all the details related to a User Plane.

- User-plane Group Name
- User-plane ID
- User-plane address
- Sxmgr-id
- IPv4 Chunks
 - Total

- Free
- Used
- Full
- IPv4 address
 - Total
 - Free
 - Used
 - Hold
 - Release
 - Busyout-Free
 - Busyout-Used
- IPv6 Chunks
 - Total
 - Free
 - Used
 - Full
- IPv6 prefixes
 - Total
 - Free
 - Used
 - Busyout-Free
 - Busyout-Used
- Total Pool count
 - IPv4
 - IPv6
- Total Pool Kernel Routes
- Max Pool Kernel Routes
- Total VRFs
- apn-without-pool-name-v4
- apn-without-pool-name-v6
- Pool-groups

show ip user-plane

The output of this command displays the details of all the User Planes that are registered with the VPN Manager.

- up-id
- user-plane-address
- user-plane-group-name
- sxmgr-id

NOTES:

- Use the **show ip user-plane up-id***up_id***user-plane-group name** *grp-name* to view the details of a specific User Plane belonging to a specific User Plane group.

show ipv6 pool-chunks pool-name <pool-name>

The output of this CLI command displays all the chunks in the IPv6 pool.

- chunk-id
- pool-id
- up-id
- total-addr
- used-addr
- busyout-free
- busyout-used

show ipv6 pool-chunks up-id <up_id> user-plane-group name <grp-name>

The output of this command displays all the IPv6 chunks that are allocated to a specific User Plane.

- chunk-id
- pool-id
- up-id
- total-addr
- used-addr
- busyout-free
- busyout-used



CHAPTER 42

IPSec in CUPS

- [Revision History, on page 327](#)
- [Feature Description, on page 327](#)
- [Limitations and Restrictions, on page 333](#)
- [Configuring DSCP in Crypto Map, on page 334](#)
- [Configuring QoS, on page 335](#)
- [Monitoring and Troubleshooting, on page 336](#)

Revision History

Revision Details	Release
First introduced.	21.25

Feature Description

IPSec is a suite of protocols that interact with one another to provide secure private communications across IP networks. These protocols allow the system to establish and maintain secure tunnels with peer security gateways. IPSec provides confidentiality, data integrity, access control, and data source authentication to IP datagrams.

IPSec AH and ESP

Authentication Header (AH) and Encapsulating Security Payload (ESP) are the two main wire-level protocols used by IPSec. They authenticate (AH) and encrypt-plus-authenticate (ESP) the data flowing over that connection.

- AH is used to authenticate – but not encrypt – IP traffic. Authentication is performed by computing a cryptographic hash-based message authentication code over nearly all the fields of the IP packet (excluding those which might be modified in transit, such as TTL or the header checksum), and stores this in a newly added AH header that is sent to the other end. This AH header is injected between the original IP header and the payload.

- ESP provides encryption and optional authentication. It includes header and trailer fields to support the encryption and optional authentication. Encryption for the IP payload is supported in transport mode and for the entire packet in the tunnel mode. Authentication applies to the ESP header and the encrypted data.

IPSec Transport and Tunnel Mode

Transport Mode provides a secure connection between two endpoints as it encapsulates IP payload, while Tunnel Mode encapsulates the entire IP packet to provide a virtual "secure hop" between two gateways.

Tunnel Mode forms the more familiar VPN functionality, where entire IP packets are encapsulated inside another and delivered to the destination. It encapsulates the full IP header and the payload.



Note The UP:UP ICSR over IPSec works only with Tunnel Mode. Transport Mode isn't supported.

IPSec Terminology

Crypto Access Control List

Access Control Lists define rules, usually permissions, for handling subscriber data packets that meet certain criteria. Crypto ACLs, however, define the criteria that must be met for a subscriber data packet to be routed over an IPSec tunnel.

Unlike other ACLs that are applied to interfaces, contexts, or one or more subscribers, crypto ACLs are matched with crypto maps. In addition, crypto ACLs contain only a single rule while other ACL types can consist of multiple rules.

Prior to routing, the system examines the properties of each subscriber data packet. If the packet properties match the criteria specified in the crypto ACL, the system initiates the IPSec policy dictated by the crypto map.

Transform Set

Transform Sets are used to define IPSec security associations (SAs). IPSec SAs specify the IPSec protocols to use to protect packets.

Transform sets are used during Phase 2 of IPSec establishment. In this phase, the system and a peer security gateway negotiate one or more transform sets (IPSec SAs) containing the rules for protecting packets. This negotiation ensures that both peers can properly protect and process the packets.

ISAKMP Policy

Internet Security Association Key Management Protocol (ISAKMP) policies are used to define Internet Key Exchange (IKE) SAs. The IKE SAs dictate the shared security parameters (such as which encryption parameters to use, how to authenticate the remote peer, etc.) between the system and a peer security gateway.

During Phase 1 of IPSec establishment, the system and a peer security gateway negotiate IKE SAs. These SAs are used to protect subsequent communications between the peers including the IPSec SA negotiation process.

Crypto Map

Crypto Maps define the tunnel policies that determine how IPSec is implemented for subscriber data packets.

There are several types of crypto maps supported in CUPS. They are:

- Manual crypto maps
- IKEv2 crypto maps
- Dynamic crypto maps

Crypto Template

A Crypto Template configures an IKEv2 IPSec policy. It includes most of the IPSec parameters and IKEv2 dynamic parameters for cryptographic and authentication algorithms. A security gateway service won't function without a configured crypto template.

Only one crypto template can be configured per service. However, a single StarOS instance can run multiple instances of the same service with each associated with that crypto template.

DSCP Marking of ESP Packets

Applications such as SRP, SX, RCM, LI, and TACACS operate between nodes that are deployed across different networks. All these applications require quick turnaround while communicating with remote systems. Marking of Encapsulating Security Payload (ESP) packets with a Quality of Service (QoS) such as Differentiated Services Code Point (DSCP) helps to determine the traffic classification for these types of packets. This feature enables prioritization of IPsec packets within their IP core network, and improves scalability of interfaces such as Sx, and SRP using IPsec.

There are two ways to apply DSCP value on the ESP packets:

- Through Application configured with DSCP value
- Through Crypto Map configured with DSCP value

Application Configured with DSCP Value

If an application such as SRP, SX, or LI supports DSCP configuration, the ESP packets after encryption check if the Type of Service (ToS) bits are set in the application IP header. If the ToS bits of the application IP header are non-zero, it copies the inner ToS bits to the ToS bits of tunnel IP header, and egress the packet. The following figure illustrates the operating procedure.

Application Configured with DSCP Value

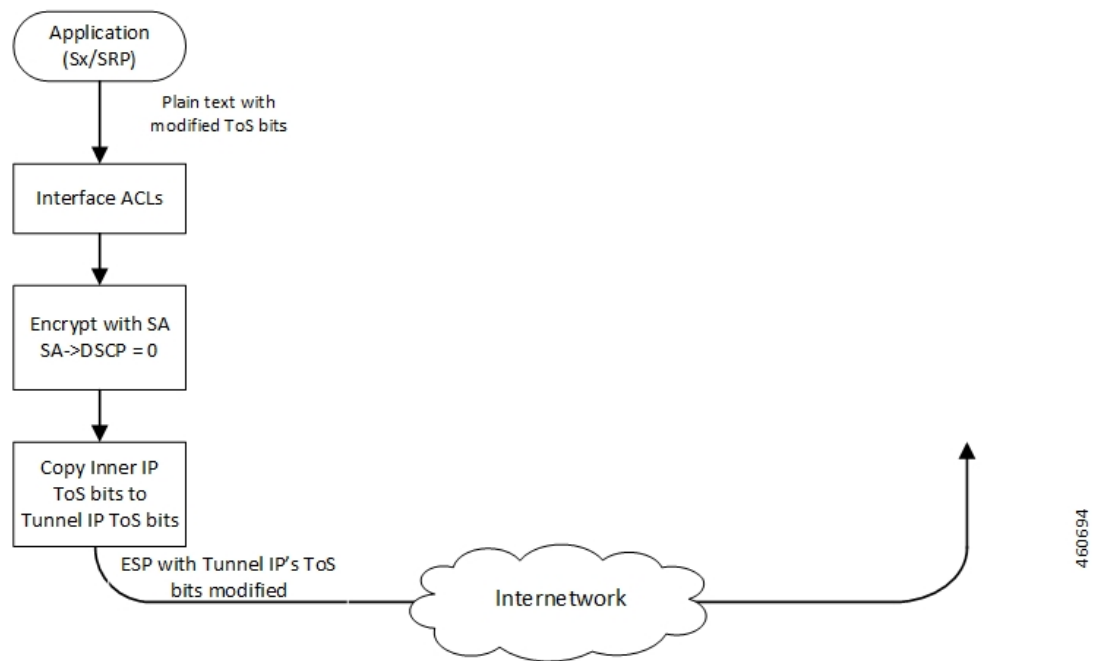

Crypto Map Configured with DSCP Value

Every application that needs to be encrypted has an associated crypto map, which is user configurable. Once the crypto map is enabled on the specific interface, Security Association (SA) database for this crypto map is updated with a DSCP value. A new field is defined in the SA database structure to hold the DSCP value. Once the packet is encrypted, it checks if the SA database has a valid DSCP value. If a valid DSCP value is found, then this DSCP value is copied to the ToS bits of tunnel IP header, and the packet is egressed. The following figure illustrates the operating procedure.

Crypto Map Configured with DSCP Value

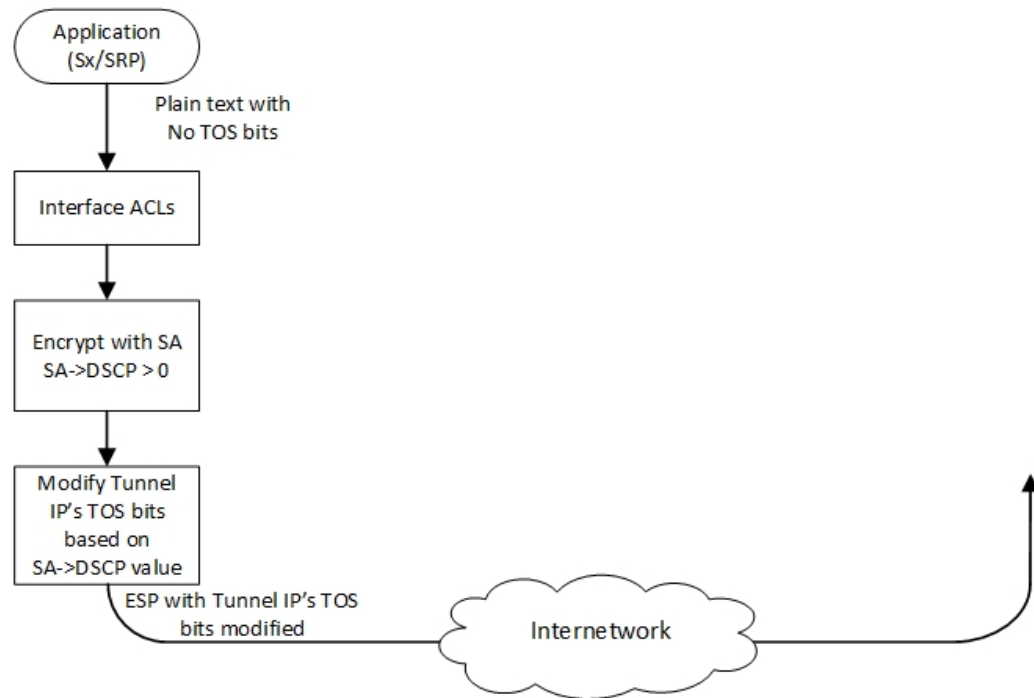

460693

Application and Crypto Map Configured with DSCP Value

If the DSCP value is configured in both crypto map and application IP header, the application ToS bits take precedence, and this value is copied to the ToS bits of Tunnel IP header. The following figure illustrates the operating procedure.

Both Application and Crypto Map Configured with DSCP Value

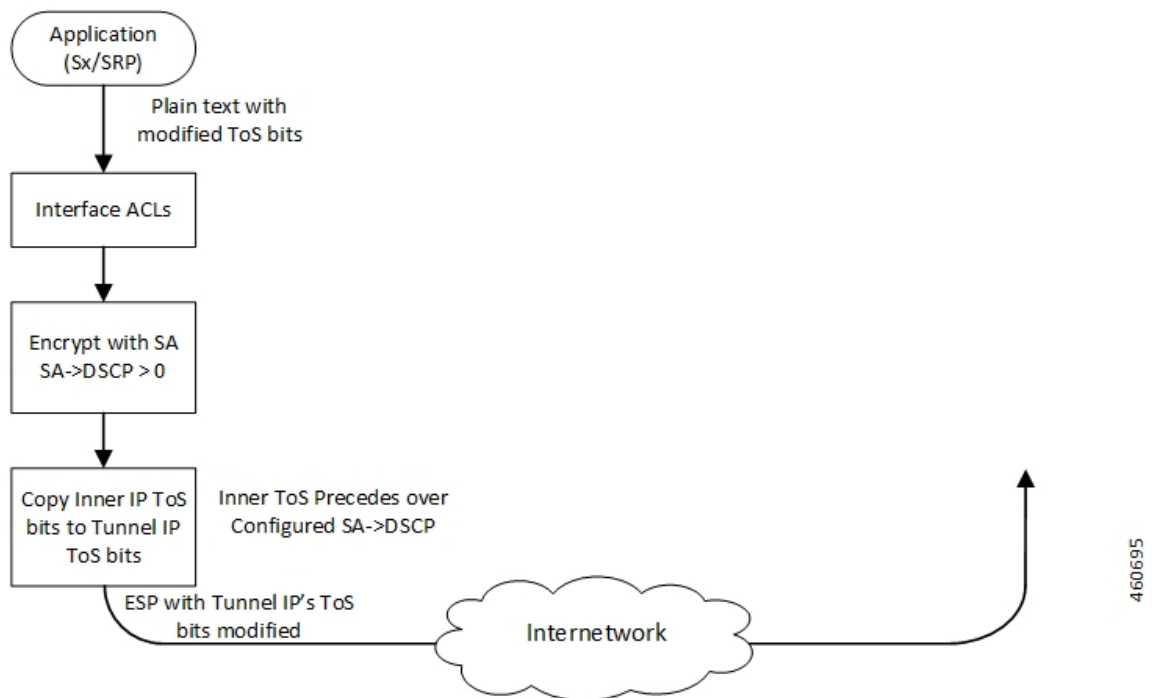

Supported Algorithms

IPSec in CUPS supports the protocols in the table below, which are specified in RFC 5996.

Protocol	Type	Supported Options (without VPP)	Supported Options (with VPP)
Internet Key	IKEv2 Encryption	DES-CBC, 3DES-CBC, AES-CBC-128, AES-CBC-256	
Exchange version 2	IKEv2 Pseudo Random Function	PRF-HMAC-SHA1, PRF-HMAC-MD5, AES-XCBC-PRF-128	PRF-HMAC-SHA1, PRF-HMAC-MD5, AES-XCBC-PRF-128
	IKEv2 Integrity	HMAC-SHA1-96, HMAC-SHA2-256-128, HMAC-SHA2-384-192, HMAC-SHA2-512-256, HMAC-MD5-96, AES-XCBC-96	HMAC-SHA1-96, HMAC-SHA2-256-128, HMAC-SHA2-384-192, HMAC-SHA2-512-256, HMAC-MD5-96, AES-XCBC-96
	IKEv2 Diffie-Hellman Group	Group 1 (768-bit), Group 2 (1024-bit), Group 5 (1536-bit), Group 14 (2048-bit)	Group 1 (768-bit), Group 2 (1024-bit), Group 5 (1536-bit), Group 14 (2048-bit)

Protocol	Type	Supported Options (without VPP)	Supported Options (with VPP)
IP Security	IPSec Encapsulating Security Payload Encryption	NULL, DES-CBC, 3DES-CBC, AES-CBC-128, AES-CBC-256, AES-128-GCM-128, AES-128-GCM-64, AES-128-GCM-96, AES-256-GCM-128, AES-256-GCM-64, AES-256-GCM-96	NULL, DES-CBC, 3DES-CBC, AES-CBC-192, AES-CBC-128, AES-CBC-256, AES-128-GCM-128, AES-128-GCM-64, AES-128-GCM-96, AES-192-GCM, AES-256-GCM-128, AES-256-GCM-64, AES-256-GCM-96
	Extended Sequence Number	Value of 0 or off is supported (ESN itself is not supported)	Value of 0 or off is supported (ESN itself is not supported)
	IPSec Integrity	NULL, HMAC-SHA1-96, HMAC-MD5-96, AES-XCBC-96, HMAC-SHA2-256-128, HMAC-SHA2-384-192, HMAC-SHA2-512-256 Important HMAC-SHA2-384-192 and HMAC-SHA2-512-256 are not supported on VPC-DI and VPC-SI platforms if the hardware doesn't have crypto hardware.	NULL, HMAC-SHA1-96, HMAC-MD5-96, HMAC-SHA2-256-128, HMAC-SHA2-384-192, HMAC-SHA2-512-256 Important HMAC-SHA2-384-192 and HMAC-SHA2-512-256 are not supported on VPC-DI and VPC-SI platforms if the hardware doesn't have crypto hardware.



Note For more information about IPSec, refer the StarOS *IPSec Reference*. Note that not all features/functionality are applicable for CUPS.

For detailed information about IPSec for Sx, LI, SRP, and so on, refer the relevant chapters in the CUPS CP Guide, CUPS UP Guide, Sx Interface Guide, and CUPS LI Guide.

Limitations and Restrictions

Following are the limitations and restrictions for this feature:

- The feature doesn't support modification of application ToS.
- DSCP value configuration in the crypto map CLI command must be added in the same context where the application is configured as **Day-1** configuration on the UP.
- If the DSCP configuration is applied after the tunnel is created, the associated crypto maps must be re-applied on the interfaces.
- If reordering of packets occurs in an SA, the receiver might discard packets because of anti-replay mechanism.

Configuring DSCP in Crypto Map

Use the following CLI commands to apply the DSCP value for the specific transform set.

```
configure
  context context_name
    ipsec transform-set set_name
      dscp dscp_value
    exit
  exit
end
```

Sample Configuration

The following is a sample configuration:

```
context ipsec-d
  ip access-list foo0
    permit tcp 209.165.200.225 209.165.200.250 209.165.200.245 209.165.200.250

  #exit

  ip access-list foo1
    permit tcp 209.165.200.225 209.165.200.250 209.165.200.247 209.165.200.250
  #exit
  ipsec transform-set A-foo
  dscp 0x28
  #exit
  ikev2-ikesa transform-set ikesa-foo
  #exit
crypto map foo0 ikev2-ipv4
  match address foo0
  authentication local pre-shared-key encrypted key encrypted_key
  authentication remote pre-shared-key encrypted key encrypted_key
  ikev2-ikesa max-retransmission 3

  ikev2-ikesa retransmission-timeout 15000

  ikev2-ikesa setup-timer 60

  ikev2-ikesa transform-set list ikesa-foo

  ikev2-ikesa rekey

  payload foo-sa0 match ipv4
  ipsec transform-set list A-foo
  lifetime 9000
  rekey keepalive
  #exit
  peer 209.165.201.1

  ikev2-ikesa policy error-notification

  #exit
crypto map foo1 ikev2-ipv4

  match address foo1
```

```

authentication local pre-shared-key encrypted key encrypted_key
authentication remote pre-shared-key encrypted key encrypted_key
ikev2-ikesa max-retransmission 3

ikev2-ikesa retransmission-timeout 15000

ikev2-ikesa transform-set list ikesa-foo

ikev2-ikesa rekey

payload foo-sa0 match ipv4

    ipsec transform-set list A-foo

    lifetime 9000

    rekey keepalive

#exit

peer 209.165.201.2

ikev2-ikesa policy error-notification

#exit

```

Configuring QoS

The ESP packets that are marked with DSCP follow the underlying L2 marking infrastructure.

The configuration to set up QoS based on the DSCP triggers the L2 marking of the ESP packets before egress from the chassis.

The following is a sample configuration:

Config

```

qos ip-dscp-iphb-mapping dscp 0x28 internal-priority cos 0x1
qos l2-mapping-table name l2Marktable
    internal-priority cos 0x1 color 0x0 802.1p-value 0x4 mpls-tc 0x6
exit
end

```

NOTES:

- **qos ip-dscp-iphb-mapping**: Creates a QoS profile.
- **dscp dscp_value**: Maps the IP DSCP values to the internal QoS.
- **internal-priority cos class_of_service_value color color_value 802.1p-value mpls_tc_value**: Maps internal QoS priority with COS values.

The following is a sample configuration to associate L2 mapping table in IPsec context:

```

config
    context ipsec-s
        associate l2-mapping-table name l2Marktable
end

```

NOTES:

- **associate l2-mapping-table:** Maps QoS from internal QoS to l2 values.
- **name table_name:** Specifies the name of table to map QoS from internal QoS to l2 values. *table_name* must be an alphanumeric string of size 1–80.

Monitoring and Troubleshooting

This section describes the CLI commands available to monitor and/or troubleshoot the DSCP Marking of ESP Packets feature.

Show Commands and Outputs

This section provides information regarding show commands and their outputs in support of this feature.

show crypto map tag tag_name: Use this command to display the configured DSCP value.

```
Map Name: foo0
=====

IPSec Manager: 54
Map status: Complete
Payload:
ACLs:
  foo0
Rules:
  permit tcp 209.165.200.225 209.165.200.250 209.165.200.245 209.165.200.250 eq 6002
Crypto Map Type: IPSEC IKEv2 over IPv4
IKE SA Transform 1/1
  Transform Set:
    Encryption Cipher: aes-cbc-128
    Encryption Accel: None
    Pseudo Random Function: sha1
    Hashed Message Authentication Code: sha1-96
    HMAC Accel: None
    Diffie-Hellman Group: 2
IKE SA DSCP Value: 0x28

IKE SA IDi [Peer]: Disabled

IKE SA DH Exponentials reuse groups : None

IKEv2 IKESA DDOS Mitigation Params:
  Half Open Timer: Disabled
  Decrypt Fail Count: Disabled
  Max IKEv2 requests Allowed : Disabled
  Message Queue Size: Disabled
  Rekey Rate: Disabled
  Max Certificate Size: Disabled

IKEv2 Notify Payload:
  Device Identity: Enabled[Default]
Notify Payload Error Message Type:
  UE: 0
  Network Transient Minor: 0
  Network Transient Major: 0
  Network Permanent: 0
```

```
Blacklist/Whitelist : None

OCSP Status          : Disabled
OCSP Nonce Status   : Enabled
OCSP Responder Address :None
OCSP HTTP version   : 1.0

Remote-secret-list: <not-configured>

Authentication Local:
  Phase 1 - Pre-Shared Key (Size = 7)

Authentication Remote:
  Phase 1 - Pre-Shared Key (Size = 7)

Self-Certificate Validation: Disabled
Certificate Server Timeout: 20 Sec
Minimum Certificate Key Size Validation: Disabled

Max Dhost Connections: 40

IPSec SA Payload 1/1
  Name : foo-sa0
  Payload Maximum Child SA: 1 [Default]
  Payload Ignore Ikesa Rekey: Disabled
  Payload Lifetime Params:
    Seconds: 90
    Sequence Number: 4293918720 [Default]
  Payload TSI Start Address: Address Endpoint
  Payload TSI End Address: Address Endpoint

IPSec SA Transform 1/1
  Transform Set:
    Protocol: esp
    Encryption Cipher: aes-cbc-128
    Encryption Accel: None
    Hashed Message Authentication Code: sha1-96
    HMAC Accel: None
    Diffie-Hellman Group: none
    ESN: Disabled
    Dscp: 0x28
  Dont Fragment: Copy bit from inner header
  IPv4 Payload fragment type: outer
  MTU: 1438 [Default]

NATT: Disabled

IKEv2 Fragmentation: Enabled
IKEv2 MTU Size IPv4/IPv6: 1384/1364

CERT Enc Type URL Allowed: Disabled
Custom FQDN Allowed: Disabled
DNS Handling: Normal [Default]

interface using this crypto-map: saegw-l1l-loopback-ipv4

Local Gateway: 209.165.202.129
Remote Gateway: 209.165.201.1
```

show qos ip-dscp-iphb-mapping: Use this command to display mapping QoS information in a packet to internal-qos marking.

DSCP	Internal Qos
0x00	0
0x01	0
0x02	0
0x03	0
0x04	0
0x05	0
0x06	0
0x07	0
0x08	0
0x09	0
0x0a	0
0x0b	0
0x0c	0
0x0d	0
0x0e	0
0x0f	0
0x10	0
0x11	0
0x12	0
0x13	0
0x14	0
0x15	0
0x16	0
0x17	0
0x18	0
0x19	0
0x1a	0
0x1b	0
0x1c	0
0x1d	0
0x1e	0
0x1f	0
0x20	0
0x21	0
0x22	0
0x23	0
0x24	0
0x25	0
0x26	0
0x27	0
0x28	1
0x29	0
0x2a	0
0x2b	0
0x2c	0
0x2d	0
0x2e	0
0x2f	0
0x30	0
0x31	0
0x32	0
0x33	0

0x34		0
0x35		0
0x36		0
0x37		0

0x38		0
0x39		0
0x3a		0
0x3b		0
0x3c		0
0x3d		0
0x3e		0
0x3f		0

show qos l2-mapping-table name *table_name* : Use this command to display named table for the internal to L2 mapping values.

Table: **l2Marktable**

Internal Class-of-service	Priority Color	802.1p	MPLS
0		0 0x0	0
0		1 0x0	0
0		2 0x0	0
0		3 0x0	0
1		0 0x4	6
1		1 0x2	1
1		2 0x2	1
1		3 0x2	1

2		0 0x4	2
2		1 0x4	2
2		2 0x4	2
2		3 0x4	2
3		0 0x6	3
3		1 0x6	3
3		2 0x6	3
3		3 0x6	3

4		0 0x8	4
4		1 0x8	4
4		2 0x8	4
4		3 0x8	4
5		0 0xa	5
5		1 0xa	5
5		2 0xa	5
5		3 0xa	5

6		0 0xc	6
6		1 0xc	6
6		2 0xc	6
6		3 0xc	6
7		0 0xe	7
7		1 0xe	7
7		2 0xe	7
7		3 0xe	7



CHAPTER 43

L2 Marking Support

- [Revision History](#), on page 341
- [Feature Description](#), on page 341
- [How it Works](#), on page 341
- [Configuring L2 Marking Support](#), on page 343

Revision History



Note Revision history details are not provided for features introduced before release 21.24.

Revision Details	Release
First introduced	Pre 21.24

Feature Description

The L2 Marking Support for CUPS enables marking of QoS Class Identifier (QCI) and Differentiated Services Code Point (DSCP) derived L2 marking for CUPS. The QoS marking support is similar to the QoS marking support that is supported on the non-CUPS platform, which ensures that the QoS treatment is maintained when the packets traverse via the L2 routers.

How it Works

This section briefly describes how L2 marking works.

Basic Functionality

- The type of the L2 marking is decided at the Control Plane (CP) as per the Service-Configuration. The types of L2 marking supported are DSCP-based, QCI-based, and None.
- When the User Plane (UP) comes up with a QCI value, the lookup is performed on the associated QCI-table for the service. Based on the lookup, the priority is selected or decided for the corresponding QCI value.

- The selected Layer 2 marking type and priority is communicated to the UP in an Sx message.
- To support the passing of new information to the UP, a new custom IE is added to the FAR IE.
 - LAYER2 MARKING:
 - TYPE PRIORITY: <type> <priority-value>
 The new custom IE is defined with the type-number : 228
- When the L2 marking changes – type or priority, the same is communicated to the UP, when the bearer update occurs.

Sx Interfaces Changes

Layer 2 Marking IE in FAR

To pass the L2 Marking information to the UP for the bearer, a new custom-IE is defined and the FAR is modified to include it as follows:

Table 24: Layer 2 Marking Information Element

Information Elements	Condition / Comment	Application				IE ID
		Sxa	Sxb	Sxc	N4	
Layer2 Marking	This IE shall indicate the type of the Layer2 Marking if present.	X	X			

The Layer 2 Marking IE is encoded as follows:

Table 25: Layer 2 Marking IE Within PFCP FAR

Octet 1 and 2		Layer2 Marking IE Type = 228 (decimal)			
Octets 3 and 4		Length = n			
Information elements	Condition / Comment	Application			
		Sxa	Sxb	Sxc	N4

Octet 1 and 2		Layer2 Marking IE Type = 228 (decimal)			
Octets 3 and 4		Length = n			
Layer 2 Marking	<p>This IE identifies the Layer 2 Marking to be applied for the packets matching this FAR.</p> <p>The length of the IE could be either 0 or 1. The 1 byte contains the following information.</p> <ul style="list-style-type: none"> • TYPE PRIORITY: <type> <priority-value> • Type : (1-DSCP, 2-QCI, 3-None) - beginning 2 Bits <p>Priority-Value: the last 6 bits</p> <ul style="list-style-type: none"> • Internal-Priority in case of QCI/None type • DCSP value in case of DSCP type 	X	X	Sxc	N4

Limitations

The following is the limitation for this feature in this release.

The change in the QCI table is not applied immediately to the subscriber. The change is applied only after the bearer update.

Configuring L2 Marking Support

The following section provides information about the CLI commands available to enable or disable the feature.

Configuring Internal Priority

To configure internal priority in the QCI-mapping table for the GGSN, GTPv1 P-GW, and SAEGW calls, use the following service specific configuration. This command in the GGSN service configuration overrides the behavior of QCI-QOS-mapping for data packets only.

```

configure
  context context_name
    ggsn-service service_name
      internal-qos data { dscp-derived | none | qci-derived }
      { no | default } internal-qos data { dscp-derived | none |
qci-derived }
    end

```

Notes:

- **no:** Disables the specified functionality.
- **default:** Disables the functionality.
- **dscp-derived:** Data packets are marked at Layer 2 based on DSCP configured in qci-qos mapping table, then if DSCP is not configured in the qci-qos mapping table then data packets are not marked.
- **none:** Data packets are not marked with Layer 2 (MPLS EXP/802.1P) marking.
- **qci-derived:** Data packets are marked at Layer 2 based on internal-qos-priority configured in qci-qos mapping table. If internal-qos priority is not configured in the qci-qos mapping table, then the data packets are not marked.

Associating QCI-QoS Mapping Table

Use the following commands to associate a QCI-QoS mapping table at the CP.

```
configure
  context context_name
    associate qci-qos-mapping { map_table_name map_table_name }
  exit
```

NOTES:

- **map_table_name** *map_table_name*: Specifies the name of an internal table from which to map the QoS to L2 values.
map_table_name must be a string of 0 through 80 characters.
- This command is disabled by default.

Configuring QCI Derived L2 Marking

Use the following commands to:

- Create or modify a Layer 2 mapping table.
- Enter the QoS L2 Mapping Configuration Mode to map internal QoS priority to Layer 2 QoS values on the User Plane (UP).

```
configure
  qos l2-mapping-table { name map_table_name | system-default }
  exit
```

NOTES:

- **name** *map_table_name*: Specifies the name of QoS mapping table from which to map QoS to L2 values. It enables internal mapping to L2 values like 802.1p, mpls, and so on.
map_table_name must be an alphanumeric string of 0 through 80 characters.
- **system-default**: Configures the system default mapping. The system default is always associated as the default for every VRF or Context.
- This command is enabled by default.

Associating L2 Mapping Table

Use the following commands to associate the configured L2 mapping table to a given VRF or Context.

```
configure
  context context_name
    associate l2-mapping-table name table_name
  exit
```

NOTES:

- **l2-mapping-table name *table_name***: Specifies the name of an internal table from which to map QoS to L2 values.

map_table_name must be an alphanumeric string of 0 through 80 characters.

- This command is enabled by default.

Configuring DSCP Derived L2 Marking

Use the following commands to modify the Differentiated Services Code Point (DSCP) to Class of Service (CoS) mapping on the User Plane (UP).

```
configure
  qos ip-dscp-iphb-mapping dscp dscp_value internal-priority cos
  class_of_service_value
  exit
```

NOTES:

- **ip-dscp-iphb-mapping**: Manages mapping of the DSCP information in a packet to the internal QoS marking.

“ip-dscp-iphb-mapping” is a global table per UP.

- **dscp *dscp_value***: Maps the IP DSCP values to the internal QoS.

dscp_value must be a hexadecimal number between 0x0 and 0x3F.

- **internal-priority cos *class_of_service_value***: Maps to the internal QoS priority or CoS.

class_of_service_value must be a Hexadecimal number between 0x0 and 0x7.

- This command is enabled by default.



CHAPTER 44

L3, L4, and L7 Rule Combination in Ruledef

- [Revision History](#), on page 347
- [Feature Description](#), on page 347
- [How it Works](#), on page 348
- [Configuring the L3, L4, and L7 Rule Combination in Ruledef Feature](#), on page 349
- [Monitoring and Troubleshooting](#), on page 350

Revision History



Note Revision history details are not provided for features introduced before release 21.24.

Revision Details	Release
Added support for CLI commands as part of the enhanced ACS feature.	21.27
First introduced.	Pre 21.24

Feature Description

The L3, L4, and L7 Rule Combination in Ruledef feature allows you to categorize traffic into specific Rating Group (RG) for:

- Specific IP addresses
- Ports
- Uniform Resource Locators (URLs)

The scalability of the host pool is increased from 256 to 512. This feature allows and defines the **url-sni-pool** configuration with 256 entries in a single pool. The entries can be a combination of URL and Server Name Indication (SNI) values. The system-wide limit of URL-SNI pools is 384 entries.

How it Works

The feature enables you to define a list of URLs or SNIs for the **url-sni-pool** configuration. The system uses a pool of URLs or SNIs as an L7 filter within a ruledef. A ruledef can contain a combination of hostpool, portmap, and url-sni pool match. The system matches the url-sni-pool configuration along with the other rule lines criteria without occupying any of the 32 existing rule lines.

Enhanced ACS Feature

The feature supports the following ECS constructs on Config Manager:

- Ruledef
- Host Pool
- PortMap
- IMSI Pool
- Group of Ruledef
- Charging Action
- URL-SNI Pool
- Rulebase
- Action-priority Lines
- Routing Ruledef
- Bandwidth Policy
- Monitoring Key
- Xheader
- ACS-level Config

The following are the new limits on ECSv2 constructs:

Construct	Limits
Ruledef	5000
Rule-lines per Ruledef	32
Group-of-Ruledef	512
Ruledef inside a Group-of-Ruledef	512
Host-Pool	1200
IP/IP ranges per Host-Pool	256
PortMap	800
Port/Port range per PortMap	20

Construct	Limits
URL-SNI-Pool	1200
URL/SNI per URL-SNI-Pool	256
IP/IP ranges per GW node	30,000
URL/SNI per GW node	30,000
Port/Port range per GW node	3000
Action-Priority line per Rulebase	3000
Action-Priority line per GW node	50,000
Routing-Priority line per GW node	5000

Enabling Enhanced ACS Feature

Use the following configuration to enable the enhanced ACS mode.

On CP:

```
configure
  require enhanced-acs-config control-plane
```

On UP:

```
configure
  require enhanced-acs-config user-plane
```



Note These two configurations takes effect only after reboot. So, you must add them in Day-0 configuration.

Configuring the L3, L4, and L7 Rule Combination in Ruledef Feature

The new URL-SNI Pool Configuration mode is available under ACS Configuration mode. Use the following configuration to enable the feature.

```
configure
  active-charging service service_name
    url-sni-pool pool_name
      http url { contains | starts-with | ends-with | = | !contains |
!starts-with | !ends-with | != } url_name
      tls sni { contains | starts-with | ends-with | = | !contains |
!starts-with | !ends-with | != } sni_identity
    ruledef ruledef_name
      ip server-ip-address host_poolname
      tcp either-port port-map port_mapname
      http-tls url-sni-pool pool_name
    end
```

**Note**

- The system configures the ruledef with the default all-lines AND option or **multi-line-or-all-lines** option.
- When the **url-sni-pool** rule line is configured, the URL or SNI value is always matched regardless of the AND or OR match operation.
- When the AND operation is configured, all the other rule lines is matched in addition to the URL or SNI value in the pool.
 - The AND operation is the default configuration.
- After configuring the OR operation, the system matches the following values for the rule action to take effect:
 - Any one of the other rule lines.
 - URL or SNI

Verifying the L3, L4, and L7 Rule Combination in Ruledef Feature Configuration

Use the following show CLI commands to verify the url-sni-pool configuration.

- On Control Plane: **show configuration active-charging service name** *service_name*

For example, the following is a partial output of the show CLI command:

```
url-sni-pool url_pool1
    http url contains google.com
    tls sni contains gmail.com
```

- On User Plane: **show user-plane-service url-sni-pool name** *pool_name*

For example, the following is a partial output of the show CLI command:

```
url-sni-pool url_pool1
    http url contains google.com
    tls sni contains gmail.com
```

```
Total url-pool(s) found: 1
```

Monitoring and Troubleshooting

Show commands and Outputs

This section provides information about the show CLI commands available in support of the feature.

show configuration active-charging service name <service_name>

Use this CLI command in Control Plane to display the url-sni-pool attachment to the ruledef.

The following is a partial sample output:

```
ruledef special_charging_group1
  ip server-ip-address range host-pool IP_FREE_MUSIC
  tcp either-port range port-map PORT_FREE_MUSIC
  http-tls url-sni-pool url_pool1
```

show user-plane-service ruledef name <ruledef_name>

Use this show CLI command in User Plane to display the url-sni-pool attachment to the ruledef.

The following is a partial sample output:

```
Ruledef Name: special_charging_group1
  ip server-ip-address range host-pool IP_FREE_MUSIC
  tcp either-port range port-map PORT_FREE_MUSIC
  Rule Application Type: Charging
  Copy Packet to Log: Disabled
  Tethered Flow Check: Disabled
  Attached Url-Sni-Pool: url_pool1
  Multi-line OR: Disabled
```



CHAPTER 45

Local Policy in CUPS

- [Revision History, on page 353](#)
- [Feature Description, on page 353](#)
- [How It Works, on page 354](#)
- [Configuring Local Policy in CUPS, on page 354](#)

Revision History



Note Revision history details are not provided for features introduced before release 21.24.

Revision Details	Release
First introduced	Pre 21.24

Feature Description

The local policies are used to control different aspects of a sessions such as - QoS, Data Usage, Subscription profiles, Server Usage, and so on, by means of locally defined policies. It is intended as a replacement or enhancement to PCRF-based policy control. The local policies are triggered during certain events and the associated conditions.

The Local Policy functionality has the following advantages:

- **Reusability:** Reusable rules engine as a common infrastructure for PCRF-based policies.
- **Resource Consumption:** Lower memory usage, CPU usage and response time.
- **Extensibility:** Extensible to handle new events and attributes with minimal effort.
- **Execution speed:** Shorter reaction time for network events.
- **Integration:** Seamless integration with the existing policy infrastructure - IMSA and PCEF with a minimal impact on existing services. In case of unreachable events, a mechanism to fallback to PCRF is implemented.

Local policies are useful in various scenarios. For example:

- A Local Policy operates as a fallback mechanism when PCRF is unavailable or when an operator has not deployed PCRF in the infrastructure.
- As an enhancer to PCRF triggers, handling certain triggers locally or to handle triggers unsupported by 3GPP Standards or PCRF.
- Deployments where the subscription policies are static and tiered or has well defined subscriber groups.
- When the response time required is less.



Note The working of the Local Policy feature in the CUPS environment is similar to the non-CUPS P-GW and SAEGW nodes.

How It Works

Local Policy feature is implemented based on the following concepts:

- Event driven rules engine. For example, RAT change event.
- On a registered Event Trigger occurrence, series of registered rules are evaluated based on the Type of Event and the current State.
- On a successful rule match, series of actions are executed.

Configuring Local Policy in CUPS



Note The CLI commands available for non-CUPS Local Policy feature are also applicable in CUPS environment.

Following is a sample Local Policy configuration in Control Plane node:

```
configure
  local-policy-service service_name
    ruledef ruledef_name
      condition priority priority radio-access-technology eq eutran
    ruledef ruledef_name
      condition priority priority apn eqcompare_string
    actiondef actiondef_name
      action priority priority default-qos qci qci_value arp arp_value
    actiondef actiondef_name
      action priority priority activate-rulebase name rulebase_name eventbase
eventbase_name
      rule priority priority event new-call ruledef ruledef_name actiondef
actiondef_name
      rule priority priority event location-change ruledef ruledef_name
```



```
actiondef actiondef_name
end
```



Note No configuration is required in User Plane node.



CHAPTER 46

Load/Overload and UP Data Throttling Support on Sx

- [Feature Description, on page 357](#)
- [How It Works, on page 357](#)
- [Configuring Load and Overload Support, on page 359](#)
- [Monitoring and Troubleshooting, on page 363](#)

Feature Description

The Load/Overload support is implemented in the UPC CUPS architecture. This support is handled between the Control Plane (CP) and User Plane (UP).

Load control enables UP to send its load information to CP to adaptively balance the PFCP session load across the UP functions according to their effective load, whereas Overload control enables throttling of new session requests towards a particular UP.

How It Works

User Plane Selection

When Load/Overload support is enabled, UP selection is implemented as given below, with a UP group:

- If none of the UP is in overload condition, Load Control Information (LCI) is used for UP selection. In this case, the least loaded UP will be selected.
- If all UPs are in the overload state, UP selection is based on the Overload Control Information (OCI). In this case the least overloaded UP is selected.
 - After a particular UP is selected, the reduction metric is still applied to this UP for throttling.
 - If throttling needs to be dropped, UP selection request is rejected for that PDN connection.
- In some scenarios where some of the UPs are in Overload condition and some of the UPs are not in Overload condition, the selection is done based on the OCI value.

- If the LCI or the OCI value are the same for a peer node, the session count information is used for UP selection.

Node-level Load/Overload Support

The CP informs the UP about the Load/Overload support enabled. Based on this information UP decides to send the Load/Overload information towards CP peer or not.

Load/Overload support at CP is configured as part of the Sx-Service node configuration. This information is sent to the UP during Sx Association Response or Sx Association Update request, if the information has changed through dynamix configuration.



Note If CP does not support Load/Overload feature through supported CLI, it ignores the reported Load/Overload by UP. In that case, UP selection continues with the session count information.

Sx Establishment Request Throttling at CP in Overload State

Once the UP is in Overload situation, CP starts throttling the Sx Establishment Request message towards UP. This avoids new calls (Low priority/non-emergency) towards the overloaded UP.

Throttling happens based on reported OCI values – Overload Reduction metric value. The value is calculated in percentage. It randomly drops the required percentage of Sx Establishment Request towards that UP Peer. This results in call drop at CP with "sx-no-resource" disconnect reason. Also, respective statistics are incremented for the same.



Note The eMPS (high priority) subscribers' Session/ Emergency Subscribers' session is not throttled.

Sx Establishment Request Throttling at UP in Self-Protection

Once the UP is in Self-Protection state, it starts rejecting all the new sessions (non-eMPS session only), Sx Establishment Request, and Sx Modification Request for the existing sessions (non-eMPS session only).

Session Termination Trigger from UP in Self-Protection

Being in Self-Protection mode, if there are no improvement in the Load condition at UP, it starts triggering Session Termination Request towards CP in a staggered manner through Sx Report Request message indicating that UP is in Self-Protection. Based on this, CP starts initiating Sx Termination Request for those sessions.

Self Protection Termination Request (SPTER): This bit is set from UP towards CP for initiating Self-Protection based termination. The CP releases the call with disconnect reason as "graceful-term-up-self-protectn".



Note When Actual Load value is greater than the Session-Termination-Start-Threshold value, Session termination is triggered towards CP.

Limitation

This feature has the following known limitations:

- The maximum number of Load/Overload profiles supported on UP is 8.
- If the Load/Overload profiles are not configured in all UPs in the UP group, it can lead to uneven distribution of sessions. It is recommended that all UPs must be configured with the Load/Overload support in a single UP group.
- After session recovery, SessMgr instance gets to relearn Load/Overload values from SxDemux. The SxDemux communicates these values only when there is a change in Load/Overload values.
- Toggling the Load Control configurations on the fly (enable to disable or disable to enable) is not supported.
- All UPs in a UP group should either be enabled or disabled. Having one of the UP enabled and another as disabled in a UP group is not supported as it can result in improper Load/Overload values on CP.
- It's recommended to disable Load Control for all IMS UPs.

Configuring Load and Overload Support

The Load and Overload support is configured using the following configurations:

- User Plane Load Control Profile Configuration
- User Plane Overload Control Profile Configuration
- Association of Load Profile to a User Plane Service
- Sx Protocol Configuration on Control Plane

User Plane Load Control Profile Configuration

Use the following commands to configure load control profile.

```
configure
  userplane-load-control-profile profile_name
end
```

Configuring User Plane Load Control Profile Parameters

Use the following configuration to configure UP Load profile parameters:

```
configure
  userplane-load-control-profile profile_name
    system-weightage system-cpu-utilization utilization_value
  system-memory-utilization utilization_value license-session-utilization
utilization_value
    sessmgr-weightage sessmgr-cpu-utilization utilization_value
  system-memory-utilization utilization_value
    inclusion-frequency advertisement-interval interval_value change-factor
```

```
change_factor_value
end
```

NOTES:

- **inclusion-frequency:** Configures parameters to decide inclusion frequency of load control information IE.
- **advertisement-interval:** Advertisement interval is the periodic interval after which the load value is advertised. Configures the advertisement interval for load control. The default value is 300. Set the value as 0 (zero) to include LCI IE in every applicable message.
- **change-factor:** Change-factor is the delta increase or decrease in the load value based on which the load advertisement occurs. Configures the change factor for load control. The default value is 5.
- **sessmgr-weightage:** Configures sessmgr weightage for various load control parameters. Total weightage of all the parameters should be 100. The default ratio is 65% weightage to sessmgr-cpu-utilization and 35% weightage to sessmgr-memory-utilization.
- **sessmgr-cpu-utilization:** Configures session manager CPU utilization weightage in percentage. Default weightage in load factor is 35%.
- **sessmgr-memory-utilization:** Configures session manager memory utilization weightage in percentage. Default weightage in load factor is 65%.
- **system-weightage:** Configures system weightage for various load control parameters. Total weightage of all the parameters should be 100. The default values are 40% weightage to system-cpu-utilization, 30% weightage to system-memory-utilization and 30% weightage to license-session-utilization.
- **system-cpu-utilization:** Configures system CPU utilization weightage in percentage. Default weightage in load factor is 40%.



Note The value displayed in the **show cpu table** CLI command is based on the average value of 5 minutes, 10 minutes, and 15 minutes. Use the result of the average value for system CPU utilization to verify the utilization manually.

- **system-memory-utilization:** Configures system memory utilization weightage in percentage. Default weightage in load factor is 30%.



Note The value displayed in the **show cpu table** CLI command is based on the average value of 5 minutes, 10 minutes, and 15 minutes. Use the result of the average value for system memory utilization to verify the utilization manually.

- **license-session-utilization:** Configures license session utilization weightage for User Plane service in percentage. Default weightage in load factor is 30%. The license utilization percentage is equal to the utilization percentage of the current UP sessions out of the maximum UP sessions.

User Plane Overload Control Profile Configuration

Use the following commands to configure overload control profile.

```

configure
  userplane-overload-control-profile profile_name
end

```

Configuring User Plane overload Control Profile Parameters

Use the following configuration to configure UP overload profile parameters:

```

configure
  userplane-overload-control-profile profile_name
    overload-threshold system lower-limit limit_value upper-limit limit_value
  sessmgr lower-limit limit_value upper-limit limit_value vpp-cpu lower-limit
limit_value upper-limit limit_value
    system-weightage system-cpu-utilization utilization_value
  system-memory-utilization utilization_value license-session-utilization
utilization_value
    sessmgr-weightage sessmgr-cpu-utilization utilization_value
  system-memory-utilization utilization_value
    inclusion-frequency advertisement-interval interval_value change-factor
changefactor_value
    tolerance tolerance_value
    validity-period validity_period
end

```

NOTES:

- **inclusion-frequency:** Configures parameters to decide inclusion frequency of overload control information IE.
- **advertisement-interval:** Advertisement interval is the periodic interval after which the overload value is advertised. Configures the advertisement interval for overload control. The default value is 300. Set the value as 0 (zero) to include LCI IE in every applicable message.
- **change-factor:** Change-factor is the delta increase or decrease in the overload value based on which the overload advertisement occurs. Configures the change factor for overload control. The default value is 5.
- **tolerance:** Configures the Overload tolerance limits.
- **validity-period:** Configures validity of overload control information. Default value is 600.
- **overload-threshold:** Configures Overload thresholds limits for system, sessmgr and vpp-cpu.
- **system:** Configures overload system threshold after which node moves to self-protection mode.
- **vpp-cpu:** Configures the overload vpp-cpu threshold after which node moves to self-protection mode.
- **sessmgr:** Configures the overload threshold for session manager after which node moves to self-protection mode.
- **upper-limit *limit_value*:** Configures the various upper limit values. Following are the various upper limit values:
 - **System Threshold Upper Limit :** Configures overload system threshold after which node moves to self-protection mode. Default limit value is 80%.

- **Sessmgr Threshold Upper Limit** : Configures overload SessMgr threshold after which node moves to self-protection mode. Default limit value is 60%.
- **vpp-cpu Threshold Upper Limit** : Configures overload vpp-cpu threshold L2 after which node moves to self-protection mode. Default limit value is 60%.
- **lower-limit *limit_value***: Configures the various lower limit values. Following are the various lower limit values:
 - **System Threshold Lower Limit**: Configures overload system threshold after which node moves to self-protection mode. Default limit value is 60%.
 - **Sessmgr Threshold Lower Limit**: Configures overload SessMgr threshold after which node moves to self-protection mode. Default limit value is 50%.
 - **vpp-cpu Threshold Lower Limit** : Configures overload vpp-cpu threshold L1 after which node moves to self-protection mode. Default limit value is 50%.
- **sessmgr-weightage**: Configures sessmgr weightage for various overload control parameters. Total weightage of all the parameters should be 100. The default ratio is 65% weightage to sessmgr-cpu-utilization and 35% weightage to sessmgr-memory-utilization.
- **sessmgr-cpu-utilization**: Configures session manager CPU utilization weightage in percentage. Default weightage in overload factor is 35%.
- **sessmgr-memory-utilization**: Configures session manager memory utilization weightage in percentage. Default weightage in overload factor is 65%.
- **system-weightage**: Configures system weightage for various overload control parameters. Total weightage of all the parameters should be 100. The default values are 40% weightage to system-cpu-utilization, 30% weightage to system-memory-utilization and 30% weightage to license-session-utilization.
- **system-cpu-utilization**: Configures system CPU utilization weightage in percentage. Default weightage in overload factor is 40%.



Note The value displayed in the **show cpu table** CLI command is based on the average value of 5 minutes, 10 minutes, and 15 minutes. Use the result of the average value for system CPU utilization to verify the utilization manually.

- **system-memory-utilization**: Configures system memory utilization weightage in percentage. Default weightage in overload factor is 30%.



Note The value displayed in the **show cpu table** CLI command is based on the average value of 5 minutes, 10 minutes, and 15 minutes. Use the result of the average value for system memory utilization to verify the utilization manually.

- **license-session-utilization**: Configures license session utilization weightage for User Plane service in percentage. Default weightage in overload factor is 30%. The license utilization percentage is equal to the utilization percentage of the current UP sessions out of the maximum UP sessions.

Associating a Load Control Profile with a User Plane Service

Use the following commands to associate the Overload Control profile to a use plane service.

```
configure
context context_name
  user-plane-service service_name
  [ no ] associate userplane-load-control-profile profile_name
```

NOTES:

- **associate:** This command associates the user plane overload control profile with a user plane service.

Sx Protocol Configuration on Control Plane

The CP Function Features IE indicates the features supported by CP. Only features having an impact on the (system-wide) UP function behaviour are signalled in this IE.

The following features are supported by CP:

- LOAD (Load Control)
- OVRL (Overload Control)

Use the following configuration to configure the supported features on CP through the Sx Protocol:

```
configure
context context_name
  sx-service service_name
    sx-protocol supported-features { load-control | overload-control
}
  no sx-protocol supported-features [ load-control | overload-control
]
end
```

NOTES:

- **supported-features:** Configures supported features for Sx interface by CP. Default value is Disabled.
- **load-control:** Enables or disables Load control feature support on CP function.
- **overload-control:** Enables or disables the Overload control feature on CP function.

Monitoring and Troubleshooting

Show Commands Input and/or Outputs

This section provides information regarding show commands and their outputs in support of the feature.

show userplane-load-control-profile name *name*

The following fields are displayed in support of this feature:

show userplane-overload-control-profile name name

- User Plane Load Control Profiles
- User Plane Load Control Profile Name
- System Weightage and Thresholds:
 - CPU Utilization Weightage
 - Memory Utilization Weightage
 - License Session Utilization Weightage
 - System Threshold Lower Limit
 - System Threshold Upper Limit
- Sessmgr Weightage and Thresholds:
 - CPU Utilization Weightage
 - Memory Utilization Weightage
 - Sessmgr Threshold Lower Limit
 - Sessmgr Threshold Upper Limit
- VPP Weightage and Thresholds:
 - VPP Utilization Weightage
 - vpp-cpu Threshold Lower Limit
 - vpp-cpu Threshold Upper Limit
- Inclusion Frequency:
 - Change Factor
 - Advertisement Interval

show userplane-overload-control-profile name *name*

The following fields are displayed in support of this feature:

- User Plane Overload Control Profiles
- User Plane Overload Control Profile Name
- System Weightage and Thresholds:
 - CPU Utilization Weightage
 - Memory Utilization Weightage
 - License Session Utilization Weightage
 - System Threshold Lower Limit
 - System Threshold Upper Limit

- Sessmgr Weightage and Thresholds:
 - CPU Utilization Weightage
 - Memory Utilization Weightage
 - Sessmgr Threshold Lower Limit
 - Sessmgr Threshold Upper Limit
- VPP Weightage and Thresholds:
 - VPP Utilization Weightage
 - vpp-cpu Threshold Lower Limit
 - vpp-cpu Threshold Upper Limit
- Inclusion Frequency
 - Change Factor
 - Advertisement Interval
- Validity Period

show user-plane-service statistics all

The following fields are displayed in support of this feature:

- Overload Stats
 - Current State : Normal
 - Number of time self-protection condition reached in user plane : 0
 - No of Session Establishment Req rejected during self-protection mode : 0
 - No of Session Modif Req rejected during self-protection mode : 0
 - No of eMPS Session Establishment Req allowed during self-protection mode : 0
 - No of eMPS Session Modif Req allowed during self-protection mode : 0
 - Overload reduction metric : 0
 - Current Overload factor system : 0
 - Current Overload factor sessmgr : 0
 - Current Overload factor vpp cpu : 0
- Overload Data Stats:
 - Total Packets dropped due to overload : 0
 - Total Bytes dropped due to overload : 0
 - Total Packets dropped in self-protection mode : 0

```
show sx service statistics all
```

- Total Bytes dropped in self-protection mode : 0
- Load Stats:
 - Load metric : 0
 - Current Load factor system : 0
 - Current Load factor sessmgr : 0
 - Current Load factor vpp cpu : 0
- eMPS PDNs Total
 - Active
 - Setup
 - Released
 - Rejected

show sx service statistics all

The following fields are displayed in support of this feature:

- Throttled

Bulk Statistics

Following bulkstats are available in support of Load and Overload Support on Sx feature.

Table 26: Supported Bulk Stats

Bulkstats	Description
num-self-protection-reached	Total number of time self-protection condition reached in UP.
num-session-estab-rejected-on-self-protection	Total number of Session Establishment Request rejected during self-protection mode.
num-session-modif-rejected-on-self-protection	Total number of Session Modification Request rejected during self-protection mode.
num-emps-session-estab-allowed-on-self-protection	Total number of eMPS Session Establishment Request allowed during self-protection mode.
num-emps-session-modif-allowed-on-self-protection	Total number of eMPS Session Modification Request allowed during self-protection mode.
overload-reduction-metric	Overload reduction metric is calculated based on the configured Lower and Upper limit of Overload Condition.

Bulkstats	Description
overload-factor-system	Overload factor system is calculated based on the System CPU, Memory, VPP CPU, and other information polled from Resource Manager (RM).
overload-factor-session	UP starts rejecting new sessions and data throttling during self-protection mode.
overload-factor-vpp-cpu	Total average VPP CPU per core during overload.
load-metric	Total number of current Load metric.
load-factor-system	Total number of current system load factor.
load-factor-session	Total number of current session load factor.
load-factor-vpp-cpu	Total number of current VPP CPU load factor.
num-packets-dropped-on-overload	Total number of packets dropped during the overload.
num-bytes-dropped-on-overload	Total number of bytes dropped during the self protection mode.
num-packets-dropped-on-self-protection	Total number of packets dropped during the self protection mode.
num-bytes-dropped-on-self-protection	Total number of bytes dropped during the self protection mode.

SNMP Traps

The following SNMP Traps are added in support of this feature:

- UPlaneSelfOverload: When system enters into Self-Protection mode.
- UPlaneSelfOverloadClear: When system is out of Self-Protection mode.



CHAPTER 47

LTE-M RAT Type Support

- [Revision History](#), on page 369
- [Feature Description](#), on page 369
- [How it Works](#), on page 370
- [Configuring LTE-M RAT-Type](#), on page 372
- [Monitoring and Troubleshooting](#), on page 373

Revision History

Revision Details	Release
First introduced.	21.27

Feature Description

LTE-M (LTE-MTC low-power-wide area (LPWA)) is a cellular radio access technology that is specified by 3GPP that addresses low power-wide area connectivity solutions. It specifically refers to a category of LTE UEs that are suitable for IoT LTE-M, which supports IoT through lower device complexity and provides extended coverage, while allowing the reuse of the LTE installed base.

The RAT Type Information Element (IE) is present in various call flows across many interfaces. When a Create Session Request is received with an unknown RAT Type, as the RAT Type is a mandatory IE in this message, S-GW or P-GW may reject a Create Session Request. With this feature, LTE-M RAT (Radio Access Technology) Type for CUPS is supported.

The RAT Type is present either as an IE (for example, in GTPv2-C, GTPP), AVP (on Diameter-based interfaces), or as an attribute (for example in EDRs) across many interfaces.

The LTE-M solution for CUPS supports the following new LTE-M RAT Type attribute value in the following interface protocols and dictionaries:

- Gx Interface: Diameter Protocol
- Gy Interface: Diameter Protocol
- Gz/Rf Interface: GTPP/Diameter/RADIUS
- S6b Interface: Diameter Protocol

- S11/ S5/S8 Interface: GTPv2-C
- RADIUS AVPs and dictionaries
- Rf interface for CDR generation
- Attributes in EDRs

Enhancements to the Existing Features

The following existing features are enhanced to support the LTE-M RAT Type:

- **Virtual APN Selection Based on RAT Type:** Virtual APNs allow differentiated services within a single APN. The Virtual APN feature allows a carrier to use a single APN to configure differentiated services. The APN that is supplied by the MME is evaluated by the P-GW with multiple configurable parameters. Then, the P-GW selects an APN configuration based on the supplied APN and those configurable parameters. APN configuration dictates all aspects of a session at the P-GW, where different policies imply different APNs.

You can select the virtual APN by configuring directly under the base APN. This APN selection is done based on RAT Types. In this release, support is added through CLI to select the virtual APN for the LTE-M RAT type.

- **QCI and QoS Mapping:** P-GW supports QCI and QoS mapping association with APN based on RAT type LTE-M. The QCI and QoS mapping allows you to perform quick actions on the QoS Class Index (QCI) to QoS Mapping Configuration Mode, which is used to map QoS Class Indexes to enforceable QoS parameters. Mapping can occur in S-GW, and/or the P-GW in an LTE network.
- **PCRF-based Handling:** P-GW informs the RAT type changes to PCRF through Credit Control Request-Initial and Updated (CCR-I and CCR-U) messages, and PCRF provides a new PCC rule. It allows you to create a bearer by enforcing a new Policy and Charging Control (PCC) rule from the Policy and Charging Rules Function (PCRF).

How it Works

As part of this feature, the RAT Type across many interfaces has been modified to include an additional value that signifies LTE-M RAT Type. Only Standard and customer-specific dictionaries are modified.

The following table specifies the field and its value for various interfaces with support of LTE-M RAT type.

Table 27:

Field	Messages
P-GW	
xC RAT-Type (1032) Diameter	M U • Credit Control Request-Initial • Credit Control Request-Updated
yG 3GPP RAT-Type (21) Diameter	M U • Credit Control Request-Initial • Credit Control Request-Updated

Field	Messages
3GPP RAT-Type (21)	<ul style="list-style-type: none"> Accounting Request-Start Accounting Request-Stop Account request-Interim
3GPP RAT-Type (21) Diameter	<ul style="list-style-type: none"> Accounting Request-Start Accounting Request-Stop Account request-Interim
3GPP RAT-Type (1032) Diameter	<ul style="list-style-type: none"> Authentication Authorisation Request
RAT-Type	—
RAT-Type (30) GTPP	<ul style="list-style-type: none"> GTPP Data Record Transfer Request
S-GW	
RAT-Type (30)	<ul style="list-style-type: none"> GTPP Data Record Transfer Request

Limitations

The LTE-M related changes are not implemented for the following functionality:

- Rule matching at ECS
- Ruledef matching at Local-Policy

Supported Standards

Cisco's implementation of the LTE RAT type complies with the following standards:

- 3GPP 23.401 Release 15.4.0 – 3rd Generation Partnership Project; Technical Specification Group Services and System Aspects; General Packet Radio Service (GPRS) enhancements for Evolved Universal Terrestrial Radio Access Network (E-UTRAN) access
- 3GPP 29.274 Release 15.4.0 – 3rd Generation Partnership Project; Technical Specification Group Core Network and Terminals; 3GPP Evolved Packet System (EPS); Evolved General Packet Radio Service (GPRS) Tunnelling Protocol for Control plane (GTPv2-C); Stage 3

- 3GPP 32.299 Release 15.4.0 – 3rd Generation Partnership Project; Technical Specification Group Core Network and Terminals; Policy and Charging Control (PCC).
- 3GPP 29.060 – 3rd Generation Partnership Project; Technical Specification Group Core Network and Terminals; General Packet Radio Service (GPRS); GPRS Tunnelling Protocol (GTP) across the Gn and Gp interface.
- 3GPP 29.061 – 3rd Generation Partnership Project; Technical Specification Group Core Network and Terminals; Interworking between the Public Land Mobile Network (PLMN) supporting packet based services and Packet Data Networks (PDN)
- 3GPP 32.298 – 3rd Generation Partnership Project; Technical Specification Group Services and System Aspects; Telecommunication management; Charging management; Charging Data Record (CDR) parameter description
- 3GPP 29.212 Release 15.4.0 – 3rd Generation Partnership Project; Technical Specification Group Core Network and Terminals; Policy and Charging Control (PCC).

Configuring LTE-M RAT-Type

Configuring Virtual APN Selection based on LTE-M RAT Type

Use the following configuration to select the Virtual-APN that is based on LTE-M RAT Type.

```
configure
  context context_name
    apn apn_name
      virtual-apn preference value apn apn_name rat-type lte-m
    end
end
```

NOTES:

- **rat-type lte-m:** Enables LTE-M as a RAT Type for Virtual APN.

Configuring QCI - QoS Mapping

Use the following configuration to configure QCI-QoS mapping for an APN.

```
configure
  qci-qos-mapping mapping_name
end
```

Associating QCI - QoS Mapping with LTE-M RAT Type

Use the following configuration to select the LTE-M RAT Type for QCI - QoS Mapping during session setup.

```
configure
  context context_name
    apn apn_name
      associate qci-qos-mapping mapping_name rat-type lte-m
    end
end
```

Verifying the QCI - QoS Mapping with LTE-M RAT Type Configuration

Check the output of the following show CLI commands to verify if QCI - QoS Mapping configuration is associated with LTE-M RAT Type:

- **show configuration**
- **show apn name *apn_name***
- **show apn name *apn_name* all**

Monitoring and Troubleshooting

This section provides information regarding commands available to monitor and troubleshoot the LTE-M RAT Type support on the SAEGW, P-GW and S-GW Services.

Show Commands and Output

This section provides information on show commands and their corresponding outputs for the LTE-M RAT type feature.

show apn statistics { all | name }

The output of the **show apn statistics { all | name }** CLI command has been enhanced to display the "LTE-M" field under "Initiated Sessions per RAT Type" and "Active Sessions per RAT Type" section.

show subscribers { full | full all | call-id <call_id> }

The output of these show CLI commands are used for monitoring the subscriber call. The output of these commands are enhanced to include "(R) - LTE-M" under "Access Tech" as part of this feature.

show subs { pgw-only | sgw-only | saegw-only } { full | full all }

The output of these show CLI commands is enhanced to display the Access Technology of the call as LTE-M:

- Access Tech: LTE-M

show session subsystem [full | verbose]

These CLIs are used for monitoring session-related statistics. The output of these commands are enhanced, as part of this feature, to display the following fields under "User Data Statistics":

- LTE Data Statistics
 - packets to User
 - octets to User
 - packets from User
 - octets from User
- LTE-M Connection Statistics

- Total Sessions
- Total calls arrived
- Total calls connected
- Total calls disconnected

show session summary

The output of this show CLI command is enhanced to display the following field: LTE-M

show subscribers { subscription full | activity all }

The output of these show CLI commands is enhanced to display the "LTE-M" field as the RAT Type of the call.

show { pgw-service | sgw-service | saegw-service } statistics { all | name }

The output of the following show CLI commands is enhanced to include "LTE-M" field as the RAT Type:

show pgw-service statistics { all | name }

This CLI is used to display the statistics per P-GW service. The output of this CLI is enhanced to display the number of "Initiated PDNs By RAT-Type" and "Current PDNs By RAT-Type" with LTE-M RAT Type per P-GW Service.

show sgw-service statistics { all | name }

This CLI is used to display the statistics per S-GW service. The output of this CLI is enhanced to display the number of "Current Subscribers By RAT-Type" and "Current PDNs By RAT-Type" with LTE-M RAT Type per S-GW Service.

show saegw-service statistics { all | name }

This CLI is used to display the statistics per SAEGW service. The output of this CLI is enhanced to display the number of "Colocated PDNs", "PGW-Anchor PDNs", "SGW-Anchor PDNs", and "GGSN-Anchor PDNs" with LTE-M RAT Type.

Bulk Statistics

The following statistics are added in support of the LTE-M RAT type feature

APN Schema

The following LTE-M RAT Type feature-related bulk statistics are available in the APN schema.

Bulk Statistics	Description
active-lte-m-sessions	The total number of active LTE-M sessions per APN (with LTE-M as RAT Type).
initiated-lte-m-sessions	The total number of initiated LTE-M sessions.

P-GW Schema

The following LTE-M RAT Type feature-related bulk statistics are available in the P-GW schema.

Bulk Statistics	Description
sesstat-pdn-rat-lte-m	The total number of PDN Type session statistics for LTE-M.
sesstat-rat-init-lte-m	The total number of initiated LTE-M PDNs (with LTE-M as RAT Type).

S-GW Schema

The following LTE-M RAT type feature-related bulk statistics are available in the S-GW schema.

Bulk Statistics	Description
sesstat-totcur-ue-lte-m	The total number of active UEs with LTE-M as the RAT Type.
sesstat-totcur-pdn-lte-m	The total number of active PDNs with LTE-M as the RAT Type.

SAEGW Schema

The following LTE-M RAT type feature-related bulk statistics are available in the SAEGW schema.

Bulk Statistics	Description
sgw-sesstat-totcur-ue-lte-m	The total number of active UEs with LTE-M as the RAT type.
sgw-sesstat-totcur-pdn-lte-m	The total number of LTE-M PDNs (P-GW anchored/Collapsed PDN) with RAT Type as LTE-M.
pgw-sesstat-pdn-rat-lte-m	The total number of LTE-M PDNs (P-GW anchored/Collapsed PDN) with RAT Type as LTE-M.
pgw-sesstat-pdn-rat-init-lte-m	The total number of initiated LTE-M PDNs.
saegw-sgw-anchor-pdn-rat-lte-m	The total number of LTE-M PDNs (S-GW anchored) with RAT Type as LTE-M.
saegw-pgw-anchor-pdn-rat-lte-sm	The total number of LTE-M PDNs (P-GW anchored) with RAT Type as LTE-M.
saegw-collapsed-pdn-rat-lte-m	The total number of LTE-M PDNs (SAEGW Collapsed PDN) with RAT Type as LTE-M.



CHAPTER 48

LTE - Wi-Fi Seamless Handover in CUPS

- [Revision History, on page 377](#)
- [Feature Description, on page 377](#)
- [How It Works, on page 378](#)
- [Configuring LTE and Wi-Fi Seamless Handover, on page 379](#)
- [Monitoring and Troubleshooting, on page 380](#)

Revision History



Note Revision history details are not provided for features introduced before release 21.24.

Revision Details	Release
First introduced	Pre 21.24

Feature Description

Seamless handovers between LTE and Wi-Fi (S2a/S2b), for UEs that need continuity with their ongoing data session, is supported in the CUPS architecture.

When handover is initiated from LTE to Wi-Fi, the Delete Bearer Request (DBR) is sent over the LTE tunnel immediately when the Create Session Response (CSR) is sent on the Wi-Fi tunnel. This causes some packet loss because of the IPSec tunnel establishment delay at the ePDG. To address the issue of packet loss, a Delete Bearer Request is sent on LTE tunnel only on expiry of the configured handover timer. If the LTE tunnel is active, uplink and downlink data are exchanged on the LTE tunnel. When handover is complete, uplink and downlink data is exchanged on the Wi-Fi tunnel. This prevents packet loss. During Wi-Fi to LTE handover, if the Modify Bearer Request is received with HI=1, it initiates a tunnel switch from Wi-Fi to LTE as per the specification.

With this feature, the following benefits are seen:

- Minimum packet loss during LTE to Wi-Fi (S2bGTP) handover and making the handover seamless (that is, MAKE before BREAK).

- LTE procedures are handled gracefully over the LTE tunnel when both tunnels are established with the P-GW.
- Wi-Fi procedures are handled gracefully over the Wi-Fi tunnel when both tunnels are established with the P-GW.

**Important**

- In an LTE to Wi-Fi or Wi-Fi to LTE handover, a tunnel identifier is allocated for new access traffic type for experiencing seamless handover.

How It Works

LTE - Wi-Fi Handover

- Before HO is started:
 - In case of multiple outstanding CCR-Us being supported, all requests before the hand-off requests are dropped.
 - Any pending transactions on LTE access are discarded. For example, if CBR or UBR is sent for LTE access and hand-off is initiated before completion of CBR or UBR transaction, then CBR or UBR is ignored at the P-GW. PCRF is not notified about failure.
- During the transition period:
 - If PCRF sends RAR for policy change, it is processed after handover is complete.
 - If ASR is received, then call drop occurs and both tunnels go down.
 - If session-release occurs from PCRF, then call is dropped and CSR is sent with cause as “no-resources”.
 - If the user moves back to LTE (that is, recurring handoff from LTE to Wi-Fi to LTE) with HO-Ind set to 1 (after guard timer), then the HO is processed successfully and user session is moved to LTE again.
 - If the user moves back to LTE (that is, recurring handoff from LTE to Wi-Fi to LTE) with HO-Ind set to 0, then it leads to context replacement. Old call is cleared on Wi-Fi access with the reason "Context Replacement", and the call is processed like a new call over LTE.
 - If Modify Bearer Command (MBC) is received in LTE (New access), it is rejected with Service-Denied message.
 - If Modify Bearer Command (MBC) is received in Wi-Fi (Old access), it is discarded.
 - If Delete Bearer Command (DBC) is received in LTE (New access) during the HO in progress, session is terminated.
 - In case of Sx Path Failure during an ongoing handover, on-going transactions are aborted, resulting in tearing down the call locally.
 - GTPC S5/S11 path failure

- During LTE to Wi-Fi HO, if path failure occurs on an older tunnel, then the call is cleared. If path failure occurs on a newer tunnel, it result in tearing the call .
- During the Wi-Fi to LTE HO, when path failure happens on an older tunnel, the older tunnel is cleared and the new tunnel call continues. This is possible only if the MBReq is pending from MME. In all other states, the call is teared down locally.
- WIFI to LTE (Collapsed call) HO, call continuation is not possible. Path failure on an older tunnel only results in tearing down the call locally.
- During the HO, if path failure occurs on a Newer tunnel, it will result in tearing down the call.

ICSR and Session Recovery

- At Control Plane, during transition, the most recent is considered as the stable state and a full checkpoint is triggered once handover is complete from LTE to Wi-Fi (S2BGTP) or vice-versa. This is applicable to Session Recovery and ICSR. User Plane has individual session recovery and ICSR check pointing on every message received.
- During handover failure, that is, when CP and UP are out of sync, the CP session is recovered on the most recently accessed state and UP is recovered in the new transition state. This behavior is applicable during UP failure.

Limitations

The LTE - Wi-Fi Seamless Handover feature does not support LTE to eHRPD and Wi-Fi to eHRPD handover and hand back.

Standards Compliance

The LTE – Wi-Fi Seamless Handover feature is compliant with the following standards:

- 3GPP TS 23.214
- 3GPP TS 29.244
- 3GPP TS 23.401
- 3GPP TS 23.402

Configuring LTE and Wi-Fi Seamless Handover

The following section provides information about the CLI commands available to enable or disable the feature. Use the following CLI commands to configure LTE to Wi-Fi handover timer.

```
configure
context context_name
  apn apn_name
    lte-s2bgtp-first-uplink timeout_value
```

```
{ default | no } lte-s2bgtp-first-uplink
end
```

NOTES:

- **default:** Enables the LTE to Wi-Fi handover completion to occur when the Create Session Response is sent on the Wi-Fi tunnel.
- **no:** Disables the feature and handover completion occurs on Create Session Response.
- **lte-s2bgtp-first-uplink *timeout_value*:** Configures LTE to S2bGTP handover completion timeout in multiples of 100 milliseconds. The valid range is from 100 to 3000. The recommended configuration is 1000 milliseconds.
- By default, the LTE to Wi-Fi handover completion happens when Create Session Response is sent on the Wi-Fi tunnel. However, after handover timeout is configured, the handover is delayed until timeout.
- Triggering handover based on first uplink data packet is not supported because the User Plane and Control Plane nodes are separated in the CUPS architecture.

Monitoring and Troubleshooting

This section provides information regarding CLI commands available in support of monitoring and troubleshooting the feature.

Show Command(s) and/or Outputs

This section provides information regarding show commands and/or their outputs in support of this feature.

show apn statistics name <name>

The output of this CLI command has been enhanced to display the following new fields for the APN:

- LTE-to-S2bGTP handover Succeeded on Timer Expiry – Specifies the number of handovers due to timer expiry.

NOTES:

The new fields, introduced as part of this feature, are also displayed for the following CLI commands:

- **show pgw-service statistics name *service_name* verbose**
- **show pgw-service statistics name all verbose**
- **show saegw-service statistics all function pgw verbose**



CHAPTER 49

Monitor Subscriber for CUPS

- [Revision History](#), on page 381
- [Feature Description](#), on page 381
- [Monitor Subscriber Sx Private IE](#), on page 383
- [Control Plane SMGR Functionality](#), on page 387
- [User Plane SMGR Functionality](#), on page 387
- [Multi PDN Multi Trace](#), on page 388
- [MonSub Stats](#), on page 389
- [X-Header](#), on page 389
- [How It Works](#), on page 389
- [Configuring the Hexdump Module for MonSub in UPF](#), on page 397
- [Monitoring and Troubleshooting](#), on page 398

Revision History

Table 28: Revision History

Revision Details	Release
First introduced.	Pre 21.24



Note Revision history details are not provided for features introduced before release 21.24.

Feature Description

The Monitor Subscriber (MonSub) feature enables tracing of subscriber-related information. It includes user and control traffic, and events such as charging and internal events that are useful for debugging. By default, this information is visible on the Control Plane console, where you can execute the MonSub tracing CLI command, and captured in a Packet Capture (PCAP) file on the User Plane.

User traffic is carried on slowpath where packets traverse to the application, or fastpath, where packets do not have to traverse up to the application, but are offloaded to fastpath processing (VPP). Slowpath mode was the default mode until the introduction of fastpath offload (VPP) into SAEGW.

Monitor Subscriber provides the following functionality:

- Continuous capture of user traffic from fastpath in PCAP files on the User Plane.
- The non-user traffic information, that is, control event traffic and other related information are displayed in Control Plane console. These information are captured in separate PCAP files on the User Plane.
- New option UP PCAP trace [W - UP PCAP Trace (ON)] is introduced for CUPS on Control Plane and User Plane in MonSub CLI. The new option is like the D option in the ICUPS. The slowpath and fastpath PCAP generates only when this option is ON.
- There are a maximum of four subscriber tracing sessions per NPUMGR instance. The NPUMGR (per User Plane instance) enforces the maximum tracing session limit. Slow-path capture naming convention contains the MonSub tracing session ID on SMGR instance, whereas fast-path tracing session contains the PSN as session ID. If there are already four tracing sessions running at SESSMGR instance, then slow-path capture is by name “S4”. It continues until the time NPUMGR rejects the tracing session due to max tracing limit reached.

Following are some of the important definitions related to this feature:

- **Chassis Traffic Volume:** The total volume of packet throughput on the chassis.
- **Monitored Traffic Volume:** Monitoring of the total throughput of all the subscribers through MonSub across all the MonSub sessions.
- **PCAP Success:** The percentage of the MonSub traffic capture request and the successful capture in the PCAP files.

Packet Processing Throughput

Following are the scenarios impacting the packet processing throughput:

- When VPP utilization is above 80%, MonSub may have an impact to packet processing throughput. The impact is in proportion to the monitored traffic volume.
- Specifically, when the monitored traffic volume approaches 10% of the chassis traffic volume, there may be an impact on the VPP throughput causing subscriber packet loss.
- The impact to packet processing throughput is higher when using monitor priorities above 0 (zero).



Caution You must be cautious during the packet processing. When VPP is running at 80% utilization and handling approximately 10-Gbps chassis traffic volume, there’s an impact on the packet processing, if the set of MonSub sessions is collectively monitoring the subscribers, totaling more than 1 Gbps of monitored traffic volume.

PCAP Success

The PCAP success depends on the following factors:

- The level of PCAP success depends on several factors, including monitored traffic volume, VPP utilization, MonSub monitor priority, and background disk I/O.
- In general, the PCAP success rates are greater for the following cases:
 - When the VPP utilization is low and/or MonSub monitor priority is above best-effort.
 - When the monitored traffic volume is less than 10% of the chassis traffic volume.

Example: When VPP is running at 80% utilization, handling approximately 10-Gbps chassis traffic volume, monitored traffic volume up to 1 Gbps is likely to yield high PCAP success percentages.

Monitor Subscriber Sx Private IE

SUBSCRIBER TRACE

The Monitor Subscriber Sx Private IE is conditional IE in the Sx Session Establishment Request and Sx Session Modification Request. This IE is valid for Sxa, Sxb and Saxb call types only.

Figure 22: Subscriber Tracing

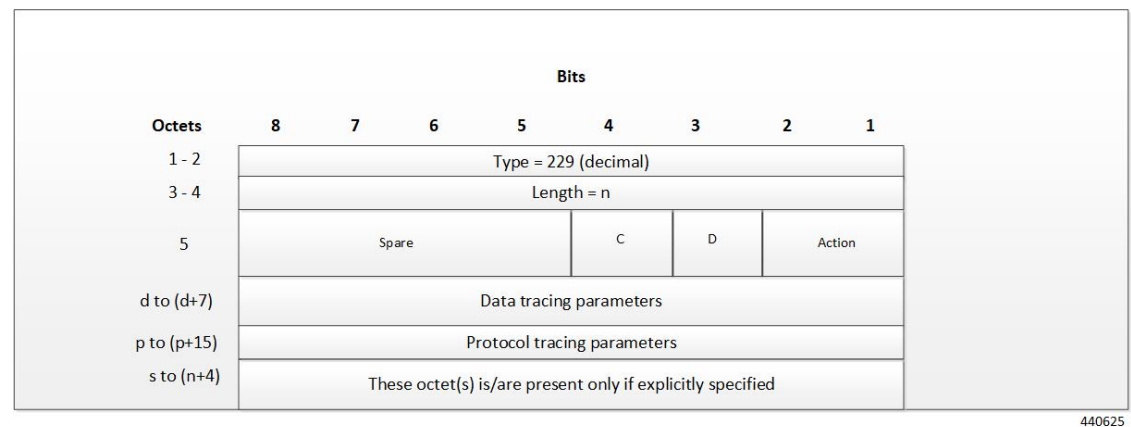

Action: STOP / START monitor subscriber tracing. STOP =1, START =2.



Note D = DATA events tracing is ON if D=1. The 8 octets (d to d+7) contain data events tracing information should be present only when D=1.

C = CONTROL events tracing is ON if C=1.

Data Tracing Information (8 octets): It will contain the data filter parameters like Packet capture, Packet capture size, and MEH header.

- Octet 1:
 - Bit 1 – VPP enable/disable
 - Bit 2 – FCAP - Packet capture

- Bit 3 – MEH present
- Bit 4 to 6 - Priority
- Octet 2 to 3: Packet size
- Octet 4 – 8: Reserved for future use. Currently, all set to 0.

Protocol Tracing Information (16 octets/128 bits): The 16 octets (p to p+15) contain protocol tracing information and should be present only when either control flag (C) or data flag (D) is enable. Each bit represents a unique protocol to monitor. Example, If 49th bit is 1, PFCP events tracing is ON. The Protocol Tracing *Rulematch Events (Option 34)*, *L3 Data (Option 19)*, *EDR (Option 77)* and *Subscriber Summary After Call Disconnect* are controlled by control event flag.

Subscriber Trace Status Report (UP to CP only)

When Subscriber Trace is enabled for a PFCP session, the Report Type IE contains one extra octet (Octet 6). Presence of this octet is indicated by the length.

Figure 23: Report Type IE

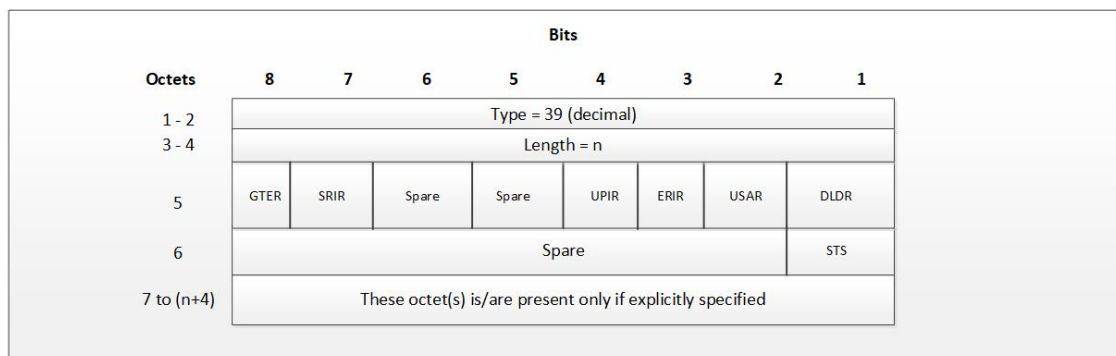

440626

Octet 5 shall be encoded as follows:

- Bit 1 – DLDR (Downlink Data Report): when set to 1, this indicates Downlink Data Report.
- Bit 2 – USAR (Usage Report): when set to 1, this indicates a Usage Report .
- Bit 3 – ERIR (Error Indication Report): when set to 1, this indicates an Error Indication Report.
- Bit 4 – UPIR (User Plane Inactivity Report): when set to 1, this indicates a User Plane Inactivity Report.
- Bit 5–6 Spare.
- Bit 7 – SRIR (Session Replacement): when set to 1, this indicates a Session Replacement request from UP.
- Bit 8 – GTER (Graceful termination): when set to 1, this indicates a Graceful Termination request from UP.

Octet 6 (present when Length>1) to be encoded as follows:

- Bit 1 – STS (Subscriber Trace Status Report): when set to 1, this indicates Subscriber Trace Status Report.

- Bit 2 to 8 – Spare.

Subscriber Trace Status Report IE (Private IE)

The Subscriber Trace Status Report IE is a conditional IE for only Sxa, Sxb and Sxab call types. For N4 call type, this IE is not present.

Figure 24: Subscriber Trace Status Report

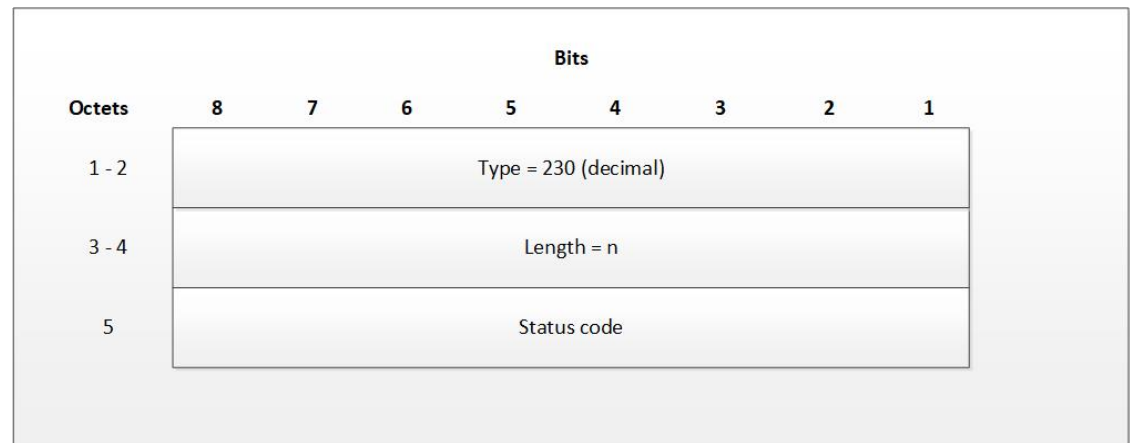

440627

The status code indicates the acceptance or the rejection of the subscriber trace at UP. Status code = 0 means, a success. Values 1-255 uniquely specifies the specific error code or notification. The list of error codes are defined post development.

Table 29: Error Code and Notification Table

Status Code	Status Description
MONSUB_SM_SUCCESS (0)	
MONSUB_SM_ERROR_FAILURE (1)	MonSub : Generic Failure status received
MONSUB_SM_ERROR_UNSUPPORTED (2)	MonSub : Unsupported Failure!
MONSUB_SM_ERROR_SESSION_EXIST_NONE (3)	MonSub : Session not Found!");
MONSUB_SM_ERROR_SESSION_LIMIT_EXCEED (4)	MonSub : Max Connections reached!
MONSUB_SM_ERROR_SESSION_INVALID_PARAM (5)	MonSub : Connect Message Failed!
MONSUB_SM_ERROR_SESSION_ALLOC_FAIL (6)	MonSub : Could not allocate monsub session at NPU!
MONSUB_SM_ERROR_CONFIG_INVALID_PARAM (7)	MonSub : Config Message Failed!
MONSUB_SM_ERROR_MONITOR_LIMIT_EXCEED (8)	MonSub : Max Stream Limit reached!
MONSUB_SM_ERROR_MONITOR_INVALID_PARAM (9)	MonSub : Monitor Message Failed!

Status Code	Status Description
MONSUB_SM_ERROR_MAX (10)	MonSub: Max Error!
MONSUB_COPROCDATA_CORRUPTED (11)	MonSub : File Handling Process Failed!
MONSUB_MAX_TRACING_SESSIONS_REACHED (12)	MonSub : Maximum Number of Tracing Sessions reached!
MONSUB_STOP_RECVD_WAIT_POLL_TIMEOUT (13)	MonSub : STOP notification is Successful. Wait till the poll-timeout configuration to start the next tracing!
MONSUB_FILECOPY_SOURCE_DIR_NOT_EXIST (14)	MonSub : Source Directory does not exist!
MONSUB_FILECOPY_DEST_DIR_NOT_EXIST (15)	MonSub : Destination Directory does not exist!
MONSUB_FILECOPY_SOURCE_DIR_OPEN_FAILURE (16)	MonSub : unable to open Source Directory!
MONSUB_FILECOPY_DEST_DIR_OPEN_FAILURE (17)	MonSub : Unable to open Destination Directory!
MONSUB_FILECOPY_SOURCE_OPEN_FAILED (18)	MonSub : Unable to open Source File!
MONSUB_FILECOPY_DESTINATION_OPEN_FAILED (19)	MonSub : Unable to open Destination File!
MONSUB_FILECOPY_DONE_FILE_DELETION_FAILED (20)	MonSub : Unable to delete .done file in Source Path!
MONSUB_FILECOPY_PCAP_FILE_DELETION_FAILED (21)	MonSub : Unable to delete .pcap file in Destination Path!
MONSUB_RESPONSE_NPUMGR_MONSUB_SESS_FAILED (22)	MonSub : Messenger Failure during Session Notification to NPUMGR!
MONSUB_RESPONSE_NPUMGR_MONSUB_CFG_FAILED (23)	MonSub-Config push to NPUMGR!
MONSUB_RESPONSE_NPUMGR_MONSUB_MONITOR_FAILED (24)	MonSub-Monitor Notification to NPUMGR!
MONSUB_RESPONSE_COPROC_FAILED (26)	MonSub : File Handling Process Failed!
MONSUB_RESPONSE_FILE_TRANSFER_SUCCESS (27)	MonSub: File Transfer successful.
MONSUB_RESPONSE_FILE_TRANSFER_FAILED (28)	MonSub: File Transfer failed!
MONSUB_ADMINISTRATIVE_DISCONNECT (29)	MonSub: Administrative Disconnect!
MONSUB_FILECOPY_DESTINATION_DISK_FULL (30)	MonSub: No space left in Destination Path!

Status Code	Status Description
MONSUB_FILECOPY_COPROC_ABRUPTLY_KILLED (31)	MonSub: File copy co-proc terminated abruptly!
MONSUB_LOGGING_COPROC_ABRUPTLY_KILLED (32)	MonSub: Logging co-proc terminated abruptly!
MONSUB_SM_DISCONNECT (33)	
MONSUB_FILECOPY_STATUS_MAX (34)	
Other	Internal Error adding protocol monitor trace - aborting...

Control Plane SMGR Functionality

Following are the modifications in the CP SMGR to support this feature:

- Provide services to the CLI for enabling or disabling the MonSub tracing.
- When you enable the MonSub for a subscriber on Control Plane, the changes propagate to the corresponding U-Plane over Sx interface as per the instructions from CP CLI.
- Any tracing failures in the UP is reported to the CP (if MonSub enabled via CP console) by a "private IE Subscriber Trace Status Report" within Sx Session Report Request message from UP to CP.
- The feature supports the tracing of four concurrent subscriber tracing sessions for fast-path and slow-path PCAP creation from CP per User Plane instance.
- The CP instance sends the CLI instance ID while enabling MonSub from CP, so that the UP sends notifications to correct CP CLI instance ID.



Note There's a race condition scenario when you enable the tracing for new/camp-on call. When the UE attach is in progress, private IE is sent in either Sx Establish Req or the Sx modify (existing attach sequence, so that the attach flow isn't disturbed). For existing calls, the private IE is sent in the Sx modify request.

User Plane SMGR Functionality

Following are the modification in the UP SMGR to support this feature.

- Provide services to the CLI for enabling or disabling the MonSub tracing.
- Based on the MonSub private IE over Sx interface from C-PLANE. Enable or Disable the MonSub tracing and generate the 'Subscriber Trace Status Report' to inform C-PLANE whether tracing is on or not.
- Control NPUMGR to connect/start/stop/add/delete streams/teq bearers and disconnect.

- The SMGR maintains the PSN from the NPUMGR (as part of CONNECT API) and sub session id, which is SMGR (local to SMGR instance) specific. The SMGR sends all requests with PSN and sub session id to NPUMGR for a monitor subscriber tracing session.
- Based on the instructions from the CLI, configures panopticon (via NPUMGR) for changes such as packet size and priority.
- Read the ‘hex dump module’ configurations and store them locally. Pass the relevant parameters (such as filename) to Session Manager Co-Proc.
- Instantiate Session Manager Co-Proc and then instruct it to copy panopticon generated PCAP files to hard disk. Also handle the termination of Session Manager Co-Proc when MonSub session is over.
- Handle file copy message from Session Manager Co-Proc and inform panopticon about the copied bundle.
- If the file copy fails or there are problems with Session Manager Co-Proc instantiation, raises the SNMP alarms.
- Handle the buffer full indications from panopticon and copy the PCAP from the ram disk to the configured destination directory.
- Capture the control/slow-path packets. Pass them to Session Manager Co-Proc to publish it as a separate PCAP.
- This feature supports a maximum of four monitor subscriber tracing sessions for a U-PLANE instance. The NPUMGR enforces the tracing limit.
- The MonSub tracing session terminates in the absence of no space on hard disk or no hard disk.
- There are coproc (file copy and logging) per UP-SMGR instance, when monitor subscriber tracing is initiated for that SMGR instance.
- The MonSub session tear down takes time depending on the final poll timer and disconnect responses from co-proc/NPUMGR.



Note There is a race condition scenario while tracing is enabled for new/camp-on call. When the UE attach is in progress, private IE is sent in either Sx/N4 Establish Request or the Sx/N4 Modify Request (existing attach sequence, so that the attach flow is not disturbed). For existing calls, the private IE is sent in the Sx/N4 Modify Request.

Multi PDN Multi Trace

For a multi-PDN call, when you start the MonSub with Multi-trace=OFF, then it traces the only one PDN as a part of that MonSub session. When new PDN is initiated then existing PDN tracing stops and new PDN tracing starts. For this, first the new PDN tracing is started and then existing PDN tracing is STOPPED and hence new PSN and SMGR sub-session ID is allocated.

For a multi-PDN call, when you start the MonSub with Multi-trace=ON, then it traces the new PDN as a part of new FASTPATH tracing session (that is MonSub session). Hence after tracing the four PDN, MonSub CLI shows max tracing session reached. Tracing of the each PDN takes place as a separate MonSub session.



Note For Pure-S call, when MonSub starts from CP, then tracing of the multi-PDN happens as a separate FASTPATH tracing session (that is separate MonSub session) irrespective of MT=ON or OFF.

MonSub Stats

A new mechanism is added to publish the stats regarding the quality of FASTPATH PCAP capture on MonSub CLI. The new mechanism publishes the stats whenever it receives the buffer full MEH indication at SESSMGR, throttled at every five seconds. The feature supports a maximum of four buffers for a FASTPATH PCAP corresponding to MonSub session. The feature does not publish the stats by default and needs to be enabled via debug CLI on UP.

- **debug uplane monsub-stats disabled**
- **debug uplane monsub-stats enabled**

The stats contains the following informations:

```
Packet accepted: 14250000          Packet rejected: 62297
Congestion Short Term: 0          Congestion Longer Term: 0
Throttled: 0                      PCAP File Transfer Rate: 9.91
  mbps
```

The PCAP file transfer rate is the rate at which copy co-proc writes the PCAP from RAM-FS to HD-RAID.

X-Header

This feature supports the X-Header capture in slow-path PCAP. The PGW-U inserts the X-HEADER for Uplink packet. The PGW-U captures the packet at entry and exit interfaces. So, the exit packet sent to SGI contains the inserted x-header.

The PGW-U inserts the X-HEADER for Downlink packet. The PGW-U captures the packet at entry and exit interfaces. So, the exit packet sent to S5-U or S1-U contains the inserted x-header.

How It Works

The Monitor Subscriber feature is discussed in detail in the following sections:

Configuration Procedure for Monitor Subscriber on UPF

The protocol monitor can be used to display information for a specific subscriber session that is currently being processed. Depending on the number of protocols monitored, and the number of sessions in progress, a significant amount of data is generated. It is highly recommended that logging be enabled on your terminal client in order to capture all of the information that is generated.

MonSub can also be initiated from UPF console. Monitoring for a given IMSI should not be enabled from both SMF and UP console.

Follow the instructions in this section to invoke and configure the protocol monitoring tool for a specific subscriber session.

Step 1 Invoke the monitor subscriber command from the Exec mode by entering the **monitor subscriber** CLI command.

```
[local]host_name# monitor subscriber { callid | imei | imsi | ipaddr | ipv6addr |
msid | msisdn | next-call | pcf | peer-fa | peer-lac | sgsn-address | type |
username }
```

An output listing all the currently available protocols, each with an assigned number, is displayed. Specify the method the monitor should use by entering the appropriate keyword.

Step 2 Specify the method the monitor should use by entering the appropriate keyword.

Select other options and/or enter the appropriate information for the selected keyword.

Step 3 Select other options and/or enter the appropriate information for the selected keyword.

If no session matching the specified criteria was being processed when the monitor was invoked, a screen of available monitoring options appears.

Step 4 Configure the amount of information that is displayed by the monitor. To enable or disable options, enter the letter or 2-digit number associated with that option (C, D, E, 11, 12, etc.). To increase or decrease the verbosity, use the plus (+) or minus (-) keys.

The current state, ON (enabled) or OFF (disabled), is shown to the right of each option.

Option **Y** for performing multi-call traces is only supported for use with the GGSN.

```
WARNING!!! You have selected options that can DISRUPT USER SERVICE
Existing CALLS MAY BE DROPPED and/or new CALLS MAY FAIL!!!
(Under heavy call load, some debugging output may not be displayed)
Proceed? - Select (Y)es or (N)o
```

Step 5 Repeat step 6 as needed to enable or disable multiple protocols.

Step 6 Press the **Enter** key to refresh the screen and begin monitoring.

The monitor remains active until disabled. To quit the protocol monitor and return to the prompt, press **q**.

Monsub CLI Options

The following options with their default value are added to existing **monitor subscriber** command.

UPF Monitor Subscriber CLI

Following are the options:

- **W** - UP PCAP Trace (ON): This parameter is used to create PCAP trace for slowpath and fastpath.
- **U** - Mon Display (ON): The non-protocol events (such as statistics and charging information from ECS and so on) are also captured in slowpath PCAP files and are displayed on UPF monitor console.
- **V** - PCAP Hexdump (ON): This flag must be set to ON to capture the protocol packets in a text file in hexdump format on UPF.



Note Currently, UP PCAP Trace flag must be set to ON to capture fastpath and slowpath PCAP files.

- **F - Packet Capture (Full Pkt)**: Captures all packets from fastpath.

Using this option, operators can choose between full and partial packet captures. By entering **F**, the packet capture type can be changed to either full or partial. With partial packet capture, users can enter packet sizes from 1 to 16384 bytes. For example, if input is given as 20, only the first 20 bytes of fastpath packets will be captured and the remaining packets will be dropped.



Note When opening the PCAP file, the summary view will display full length of the packet, but the detailed view will show only the truncated packet.

- **/ - Priority (0)**: The value is in the range from "0 – Best Effort" to "7 – Guaranteed"
 - 0 - Best Effort
 - 1 - Low
 - 2 - Med-Low
 - 3 - Medium
 - 4 - Med-High
 - 5 - High
 - 6 - Critical
 - 7 - Guaranteed



Caution It is strongly recommended to not change the default value. It can adversely affect the system performance.

- **N - MEH Header (OFF)** : The MEH header is stripped from the IP packet if this option is configured

Show Monitor Subscriber Sessions

Following is the new CLI to show the ongoing MonSub session.

You can trigger the **show monitor subscriber fastpath session all** CLI command from both SMF and UPF. You can trigger the **show monitor subscriber fastpath session up-ip-address** CLI command from the SMF

- **SessId**: This is the local session id for MonSub session on UPF Sessmgr.
- **CallID**: Call ID on UPF.
- **PSN**: This is panopticon sequence number. There is a maximum of four MonSub fastpath tracing sessions on one UPF with PSN ranging from 0-3.
- **Start time**: Time at which MonSub tracing session starts.

- **Interface Type:** This is to identify the call type for which MonSub fastpath tracing session was started, whether it is Sxa, Sxb or Sxab.

Disconnect Monitor Subscriber Sessions

Following is the new CLI to disconnect the ongoing MonSub session. You can trigger the CLI from both CP and UP.

```
monitor subscriber fastpath disconnect sessmgr-instance upf_sessmgr_instance_id session-id
local_monsub_sessid_sessmgr_level
```

If the MonSub session disconnect is successful, the following message displays on console.

```
Session Disconnected Successfully
```

If the MonSub session disconnect fails, the following message displays on console.

```
Monitor Subscriber session does not exist
```



Note Only security administrator can execute the monitor disconnect CLI.

Context, CDRMOD, and Hexdump Interaction for Monitor Subscriber

Hexdump module must be configured to provide operators the provision to configure Files names and Poll timers. The Hexdump module is one of the modules such as—EDR, UDR, and so on, that are part of the CDRMOD functionality. Configure the hexdump in a non-local context such as the ECS context. The local context does not support Hexdump modules.

For more information on Hexdump module and its configuration, refer to the [Configuring the Hexdump Module for MonSub in UPF](#) section.

PCAP File Name Convention

Following section discusses the naming conventions for PCAP files:



Note Only **monitor-subscriber-file-name** and **rotation** options are used in naming PCAP files.

Slowpath File Name Convention

The slowpath file names appear in the following format:

```
curr_slowpath_{SMGR Mon Sub Session
Id}_{monsub_file_name_option_val}_{Timestamp}_{RotationCount}.pcap
```

or

```
slowpath_{SMGR Mon Sub Session
Id}_{monsub_file_name_option_val}_{Timestamp}_{RotationCount}.pcap
```

File with 'curr_' prefix is the file, that is currently being written to, which is still not closed. When files are to be rotated (depending on the file rotation parameters), file without the 'curr_' prefix are copied to hard disk.

The SMGR MonSub Session Id – This is the session Id for MonSub session created on Uplane SMGR instance ID, which created this PCAP. This Id is local to SMGR instance, so there could be two SLOWPATH pcap captured with same ID.

When files are to be copied to hard disk, the `monsub_file_name_option_val` is replaced by:

- IMSI value if **monitor-subscriber-file-name** is set to "imsi".
- Call ID value if **monitor-subscriber-file-name** is set to "call-id"
- Username value if **monitor-subscriber-file-name** is set to 'username'

Timestamp is in the following format "MMDDYYYYHHMMSS", where:

- MM - Month, DD - Date and YYYY - Year.
- HH -Hour, MM - Minutes and SS - Seconds.

RotationCount is a 9-digit value that is incremented every time an old file is rotated, and a new file is generated. 00000000 for the first file, 00000001 for the second file and so on.

Rotation of slowpath files is determined by following option in **hexdump-module file** configuration:

rotation { num-records *number* | time *seconds* | volume *bytes* }

- **num-records:** num-records specifies the number of packets after which, a new file is generated and 'RotationCount' in the filename is incremented. The range of number is between 100 to 10240, and the default value is 1024.
- **time:** time specifies the time to wait in seconds before a new file is generated and 'RotationCount' in the filename is incremented. seconds must be an integer from 30 through 86400. The default value is 3600.
- **volume:** volume specifies the number of bytes after which a new file is generated and 'RotationCount' in the filename is incremented. bytes must be an integer from 51200 through 62914560. The default value is 102400.



Note The **tarriff-time** parameter under rotation is ignored as it is not suitable for PCAP file capture.

The following are examples of the file naming conventions for slowpath PCAP files:

- For the 'imsi' option where IMSI is '112233445566778', slowpath files are named as:

```
slowpath_s0_112233445566778_07152019050907_000000000.pcap
```

- For 'call_id' option where Call Id is '01317b22', slowpath files are named as:

```
slowpath_s0_01317b22_07152019050907_000000000.pcap
```



Note The parameter **tarrif-time** is not applicable for PCAP file capture.

Fastpath File Name Convention

The fastpath file names appear in the following format:

```
vpp_{S}_{B}_{encap}_{monsub_file_name_option}_{Timestamp}_{FileCount}.pcap
```

- S is replaced by either 'S1', 'S2', 'S3', or 'S4'.
- B is replaced by either 'B0', 'B1', 'B2', or 'B3' depending on the bundle generated by Panopticon.
- monsub_file_name_option is replaced by:
 - IMSI value if **monitor-subscriber-file-name** is set to "imsi".
 - Call ID value if **monitor-subscriber-file-name** is set to "call-id"
 - Username value if **monitor-subscriber-file-name** is set to 'username'

Timestamp is in the following format "MMDDYYYYHHMMSS", where:

- MM - Month, DD - Date and YYYY - Year.
- HH -Hour, MM - Minutes and SS - Seconds.

RotationCount is a 9-digit value that is incremented every time an old file is rotated, and a new file is generated.

00000000 for the first file, 00000001 for the second file and so on.

Fast path "FileCount" is not the same as the slowpath "RotationCount" parameters and hence 'hexdump-module file rotation' parameters are ignored while naming fastpath files.

In Phases 1 of the feature, fastpath generated file names are like 'vpp_S1_B0_ip.pcap' or 'vpp_S1_B1_ip.pcap', they are renamed to following when being copied over to non-volatile storage:

- vpp_S1_B0_ip_01317b22_07152019050907_000000000.pcap
- vpp_S1_B1_ip_01317b22_07152019050908_000000001.pcap
- vpp_S1_B0_ip_01317b22_07152019050908_000000002.pcap

In MonSub phase 3, a PCAP "bundle" is replaced with a single PCAP file that uses Ethernet encapsulation.

In Phase 3, each fastpath session file is captured in the Ethernet PCAP file that is 'vpp_S0_B0_eth.pcap' and they are renamed to following when being copied to a non-volatile storage:

```
vpp_S0_B0_eth_01317b22_07152019050907_000000000.pcap
```

For 'callid' option where Call Id is '12345678ef':

- slowpath_S0_12345678ef_07152019050907_000000000.pcap
- vpp_S1_B0_eth_12345678ef_07152019050907_000000000.pcap

For 'username' option where username is '9890098900':

- slowpath_S0_07152019050907_000000000_9890098900.pcap
- vpp_S1_B0_eth_07152019050907_000000000_9890098900.pcap

PCAP File Location

Fastpath PCAP files are written to the `/records/pcap` directory in same card and CPU complex where the session manager owns the subscriber session resides.

`/records` directory is mapped to the "tmpfs" filesystem that is mapped to RAM. In this state, the files are suffixed with a ".pending" extension. For example:

```
-rw-rw-r-- 1 root root 268599296 Sep 23 14:04 vpp_S1_B0_eth.pending
```



Note The files size at this stage is not the actual file size when it is written to a persistent storage.

Once the fastpath tracing mechanism has written the files, they are converted to '.pcap' files and renamed as given below. Additionally, there is a file that ends with a ".done" extension:

```
-rw-rw-r-- 1 root root 8689188 Oct 16 22:06 vpp_S0_B0_eth.pcap
```

After the PCAP files are written by fastpath tracing mechanism, the Co-Proc functionality instantiates and copies the files to a hard disk or a persistent storage.

The aforementioned file location process for Fastpath is also applicable to Slowpath.

The target file location in all cases is: `/hd_raid/records/hexdump`, except for the case in the `hexdump` module configuration where **use-harddisk** is enabled and the **directory** option under the **hexdump file** is to a custom value. For example, if the **directory** option is set to a value "abc" then the target location for the PCAP file will be: `/hd_raid/records/hexdump/abc/`.

In this feature implementation, a predefined location is set for PCAP files.

- To make sure that `/records/pcap` directory is not populated when issues are encountered with the use of **use-harddisk** and **hexdump module** configurations.
- For regular cleanup from `/hd_raid/records/hexdump` directory.

File Transfer to External Location

Once the files have been copied to the hard disk, they can be copied over to an external server using the command: **transfer-mode** option under the **hexdump** command in the **hexdump-module** configuration.

Apart from **transfer-mode**, other relevant options under **hexdump** can be used for external file transfer. Operators can use these commands to avoid excessive storage during fastpath processing.

Limitations

Following are the Limitations:

- Restarting trace immediately after quitting may result in fastpath files in `/records/pcap` directory to be overwritten. It is recommended to restart the session after a brief moment (a few seconds).
- When MonSub trace is stopped, the tear down process can take a few seconds, so it is recommended to wait for few seconds. A maximum of five seconds (`hexdump` poll timer value in seconds) before toggling the MonSub trace to start, else, operators may observe MAX TRACING SESSIONS REACHED momentarily.

- Show monitor subscriber fastpath sessions CLI does not display the MonSub sessions that are being stopped. Hence there is a transient period where new MonSub sessions can be rejected due to max sessions reached, whereas show CLI shows less sessions. It is recommended that operators wait for some time before starting a new MonSub trace session.
- Changing fastpath configuration options is only possible when **UP Pcap Trace** is set to OFF.
- When MT=ON in the Multi-PDN, then once MT=OFF, new PDN tracing is not started due to MAX TRACING REACHED, and then all other tracing is STOPPED. This is because the first new PDN tracing is started and then all previous PDN's were STOPPED for MT=OFF case.
- It is recommended to not to launch the same UE MonSub sessions from different CLIs.
- In slowpath PCAP, the egress DL packets does not show the GTPU-U header because the functionality to add GTP-U is with fastpath. So, ingress and egress DL packets shows up the duplicates, unless there is some packet modification like HTTP X-headers applied over the ingress packets.
- Toggling C and D options does not impact the PCAP capture.
- For Multi-PDN, the fastpath filenames does not use the Call Id, because, by definition the multi-PDN case has more than one call id and hence a higher-level configuration such as IMSI is more suitable for naming the files.
- Only the named options explicitly mentioned in this document are supported from *hexdump-module file* configuration.
- Number of streams that can be traced in fastpath is limited to 5000. Stream is defined as a TCP or UDP flow which is made up of (source IP address, destination IP address, source port, and destination port, transport protocol (TCP or UDP)).
- Fastpath packets cannot be streamed to an external server. They are stored on the hard-disk and transferred (either manually) or by using **transfer-mode** options.
- The UP PCAP trace must be set to ON to capture fastpath and slowpath PCAP files.
- MonSub CLI option '<SPACE> Pause' is only to pause console events. There is no impact on other tracing events (slowpath PCAP, fastpath PCAP and protocol packets tracing in a text file in hexdump format) with this option.
- The UP trace PCAP file does not contain the initial PFCP Sx Request/Response, due to race condition.
- The ICMP Packets and a first packets of TCP and UDP streams flow through both slowpath and fastpath. Default values of GTPU (option 26) and User L3 (Option 19) are set to OFF. As a result, these packets are not captured in slowpath captures. If Option 26 is set to ON then these packets are captured in slowpath PCAP captures. As mentioned in previous point, option 19 has no effect on slowpath PCAP capture.
- Data Events flag must be set to ON to capture fastpath and slowpath PCAP files.
- Only firstPDN tracing is supported for Pure-Scall. This limitation will be fixed with multiple subscriber tracing support.
- The Mon sub tracing is not supported for option **Next-SAEGW Call** on UP.
- The Mon sub tracing is not supported for option **Next call by APN** for Pure-S call type.
- On ASR 5500 setup with the default value of poll-timer, all the packets may not be captured due to a known issue. To avoid large number of packets to be rejected, it is recommended to change the poll-timer value to the lowest possible (10ms).

- If context replacement occurs (if the same subscriber reattaches without a detach) then the slowpath captures for the new call continues to be in the old slowpath files.

Configuring the Hexdump Module for MonSub in UPF

Configuring MonSub Poll Timer

Use this configuration to set the frequency of PCAP file capture check.

```
configure
  context context_name
    hexdump-module
      hexdump monitor-subscriber-poll-timeout poll_timer_value
    end
```

NOTES:

- **hexdump monitor-subscriber-poll-timeout** : This option specifies how frequently the check for newly captured PCAP files in the volatile storage must be done before they are copied to persistent storage.
- *poll_timer_value*: Specifies the poll timer value in milliseconds. It must be an integer in the range of 10 ms to 60 seconds. Default: 30 seconds.



Note The timer should not be configured with a value less than 5 seconds.

- This option is only applicable when MonSub is enabled for the products that have fastpath functionality - PGW, SAEGW on ASR-5500 and VPC-SI.

Configuring MonSub File Name

Use the following configuration to specify the file name of the PCAP file which contains IMSI, Call ID, or Username.

```
configure
  context context_name
    hexdump-module
      file rotation { num-records number | tariff-time minute minutes hour
        hours | time seconds | volume bytes | monitor-subscriber-file-name { imsi |
        username | call-id }
    end
```

NOTES:

- **monitor-subscriber-file-name { imsi | username | call-id }**: This option specifies if the name of the captured PCAP files will contain IMSI, Call Id or Username. This option is only applicable on products that have fastpath functionality (PGW, SAEGW on ASR 5500 and VPC-SI) AND only when Monitor Subscriber functionality is enabled. Default: IMSI.

- **rotation { num-records *number* | tariff-time *minute minutes hour hours* | time *seconds* | volume *bytes* }**: Specifies when to close a hexdump file and create a new one.
 - **num-records *number***: Specifies the maximum number of records that should be added to a hexdump file. When the number of records in the file reaches this value, the file is complete.
number must be an integer from 100 through 10240. Default: 1024
 - **tariff-time *minute minutes hour hours***: Specifies to close the current hexdump file and create a new one based on the tariff time (in minutes and hours).
minutes must be an integer from 0 through 59.
hours must be an integer from 0 through 23.
 - **time *seconds***: Specifies the period of time to wait (in seconds) before closing the current hexdump file and creating a new one.
seconds must be an integer from 30 through 86400. Default: 3600



Important

Set the rotation time to 30 seconds.

- **volume *bytes***: Specifies the maximum size of the hexdump file (in bytes) before closing it and creating a new one.
bytes must be an integer from 51200 through 62914560. Note that a higher setting may improve the compression ratio when the compression keyword is set to gzip. Default: 102400

Monitoring and Troubleshooting

This section provides information regarding monitoring and troubleshooting the Monitor Subscriber feature.

SNMP Traps

The following SNMP trap(s) are added in support of the Monitor Subscriber feature:

- **MonSubProcessInitFailure**: This trap is triggered when MonSub handler process has failed for a particular process and service.



CHAPTER 50

MPLS Support on VPC-SI for CUPS

- [Revision History, on page 399](#)
- [Feature Description, on page 399](#)
- [How it Works, on page 400](#)
- [Monitoring and Troubleshooting, on page 410](#)

Revision History



Note Revision history details are not provided for features introduced before release 21.24.

Revision Details	Release
First introduced	Pre 21.24

Feature Description

In the existing platforms (VPC-DI, ASR 5500), the boxer supports MPLS, which uses the underlying dataplane forwarder to switch MPLS traffic. In ASR 5500, the NP4c network processor generates and processes MPLS traffic while in VPC-DI, the IFTask generates and processes MPLS traffic.

The MPLS Support on VPC-SI for CUPS feature enables MPLS support on VPC-SI (SI-CUPS), which uses VPP as the dataplane forwarder.

VPP supports and provides multiple dataplane features that include the MPLS stack as a separate graph node. VPP generates labeled packets and simultaneously processes incoming labeled packets. This helps differentiate between different customer VRFs to support a large number of corporate APNs having different addressing models and requirements.

The MPLS Support on VPC-SI for CUPS feature supports the following functionalities:

- Uses the VPP MPLS stack to send the MPLS labeled packet.
- Uses the VPP MPLS stack to process the incoming labeled MPLS packet.

- Supports all existing MPLS configuration (VPC-DI, ASR 5500) and provides feature parity with new deployments using VPC-SI CUPS.
- Supports VPPCTL CLI commands to display NHLFE and ILM tables that are in VPP for debugging and comparing values with boxer configuration.

How it Works

This section briefly describes how the MPLS Support on VPC-SI for CUPS works.

In the current CUPS architecture, VPP forwarder provides its own MPLS stack, which supports all the existing functionalities for MPLS packet processing. The VPP MPLS stack is configured with the appropriate Next-Hop Label Forwarding Entry (NHLFE) and incoming label map (ILM) tables. This helps generate the MPLS packet on the egress with the correct MPLS header. It also processes the incoming MPLS packet and switches this packet based on the incoming labels to the appropriate next hop table identifier (VRF context of the subscriber) based on the incoming label.

The MPLS solution supports the following scenarios:

- [MPLS-CE Connected to PE](#)
- [VPC-SI as a PE](#)

VPC-SI also supports VPNv6 as described in RFC 4659 – *BGP-MPLS IP Virtual Private Network (VPN) Extension for IPv6 VPN*.

MPLS-CE Connected to PE

The VPC-SI functions as an MPLS-CE (Customer Edge) network element connected to a Provider Edge (PE) Label Edge Router (LER), which in turn connects to the MPLS core as per RFC 4364.

The following figure illustrates the MPLS-CE to PE connection:

Figure 25: VPC-SI MPLS-CE to PE

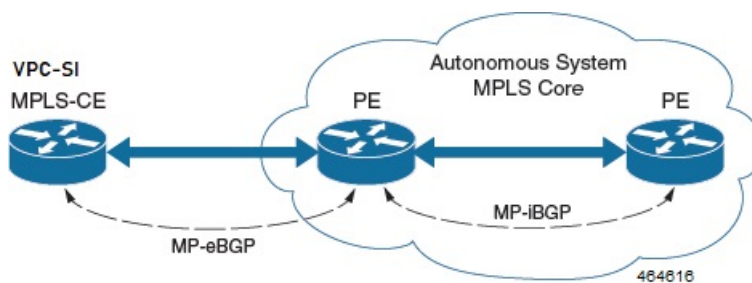

The MPLS-CE functions like a PE router within its own Autonomous System (AS). It maintains Virtual Routing and Forwarding (VRF) routes and exchanges VPN route information with the PE through an MP-eBGP (Multi Protocol external BGP) session.

The PE is also configured with VRFs and exchanges VPN routes with other PEs in its AS through MP-iBGP (Multi Protocol internal BGP) connection and MPLS-CE through an MP-eBGP connection.

The EBGP connection allows the PE to change next-hop IP addresses and labels in the routes learnt from IBGP peers before advertising them to the MPLS-CE. The MPLS-CE uses only MP-eBGP to advertise and

learn routes. Label Distribution Protocol (LDP) and Resource Reservation Protocol (RSVP) are not required because of direct-connect EBGP peering. The MPLS-CE pushes or pops a single label (learnt over the MP-eBGP connection) to or from the PE.

VPC-SI as a PE

Overview

In this scenario, the VPC-SI functions as a PE router sitting at the edge of the MPLS core. See the figure below.

Figure 26: VPC-SI as a PE

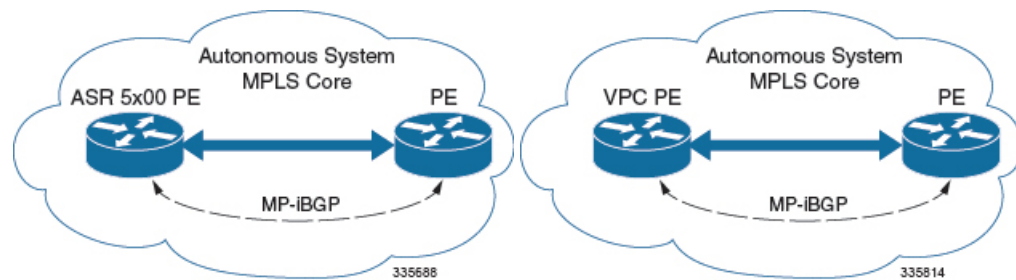

The VPC-SI eliminates the need for an ASBR or PE as shown in the first two scenarios. In this scenario, two main requirements are introduced: IBGP functionality and MPLS label distribution protocols.

The VPC-SI can be configured to add two labels:

- an outer label learned from LDP or RSVP-TE (RSVP-Traffic Engineering)
- an inner label learned from MP-iBGP

This solution supports traffic engineering and QoS initiated via the VPC-SI.

Sample Configuration

In this example, VRFs are configured on the ASR 5500 PE and pools are associated with VRFs. The VPC-SI exchanges VPN routes with its IBGP peers (PE routers) and learns the MPLS paths to reach PEs via LDP. The VPC-SI forwards the packets to the next-hop with two labels – an inner label learned from PE and an outer label learned from the next hop IBGP neighbor.

Figure 27: Sample Configuration

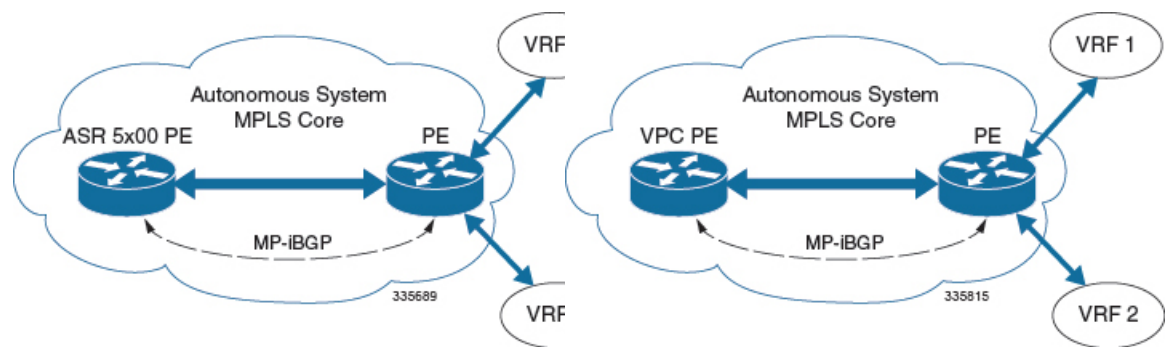

```

mpls ip
  protocol ldp
  enable
  exit
exit

ip vrf vrf1
  mpls traffic-class copy
  exit
ip vrf vrf2
  mpls traffic-class value 5
  exit

router bgp 300
  ip vrf vrf1
    route-target export 300 1
    route-target import 300 1
    route-distinguisher 300 1
  exit
  ip vrf vrf2
    route-target export 300 2
    route-target import 300 2
    route-distinguisher 300 2
  exit

router-id 209.165.201.1
neighbor 209.165.200.225 remote-as 300
neighbor 209.165.200.225 update-source node1_loopback

address-family vpnv4
  neighbor 209.165.200.225 activate
  neighbor 209.165.200.225 send-community both
  neighbor 209.165.200.225 next-hop-self
  exit

address-family ipv4 vrf vrf1
  redistribute connected
  exit

address-family ipv4 vrf vrf2
  redistribute connected
  exit

interface interface_to_internet
  ip address 209.165.200.224/27
  mpls ip
  exit
router ospf
  network 209.165.201.0/27 area 209.165.201.5
  exit

```

IPv6 Support for BGP MPLS VPNs

Overview

The VPC-SI supports VPNv6 as described in RFC 4659 – *BGP-MPLS IP Virtual Private Network (VPN) Extension for IPv6 VPN*.

An IPv6 VPN is connected over an IPv6 interface or sub-interface to the Service Provider (SP) backbone via a PE router. The site can be both IPv4 and IPv6 capable. Each VPNv6 has its own address space which means

a given address denotes different systems in different VPNs. This is achieved via a VPNv6 address-family which prepends a Route Distinguisher (RD) to the IP address.

A VPNv6 address is a 24-byte quantity beginning with an 8-byte RD and ending with a 16-byte IPv6 address. When a site is IPv4 and IPv6 capable, the same RD can be used for the advertisement of both IPv4 and IPv6 addresses.

The system appends RD to IPv6 routes and exchanges the labeled IPv6-RD using the VPNv6 address-family. The Address Family Identifier (AFI) and Subsequent Address Family Identifier (SAFI) fields for VPNv6 routes will be set to 2 and 128 respectively.

The IPv6 VPN traffic will be transported to the BGP speaker via IPv4 tunneling. The BGP speaker advertises to its peer a Next Hop Network Address field containing a VPN-IPv6 address whose 8-octet RD is set to zero and whose 16-octet IPv6 address is encoded as an IPv4-mapped IPv6 address (RFC 4291) containing the IPv4 address of the advertising router. It is assumed that only EBGP peering will be used to exchange VPNv6 routes.

Support for VPN-IPv6 assumes the following:

- Dual Stack (IPv4/IPv6) routing
- IPv6 pools in VRFs
- BGP peering over a directly connected IPv4 interface

See the figure below.

Figure 28: IPv6-RD Support for VPNv6

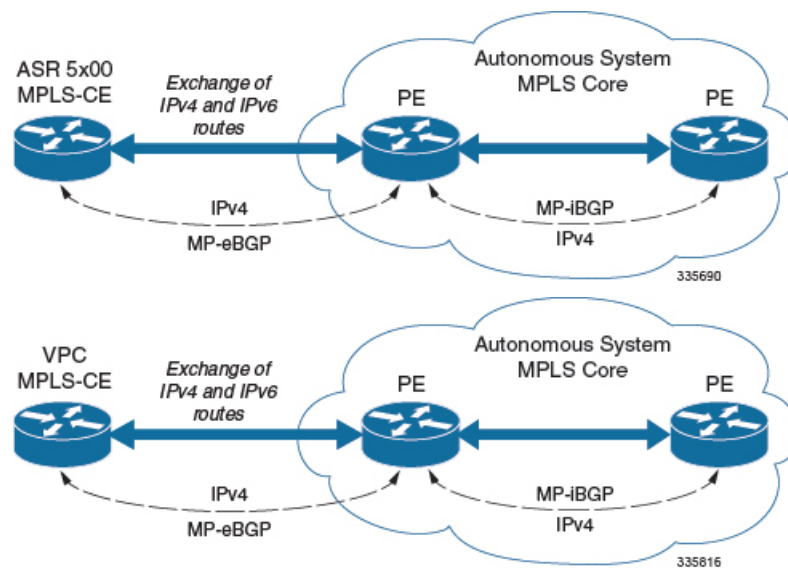

Sample Configuration

This example assumes three VRFs. VRF 1 has only IPv4 routes, VRF 2 has both IPv4 and IPv6 routes, and VRF 3 has only IPv6 routes.

Figure 29: VPNv6 Sample Configuration

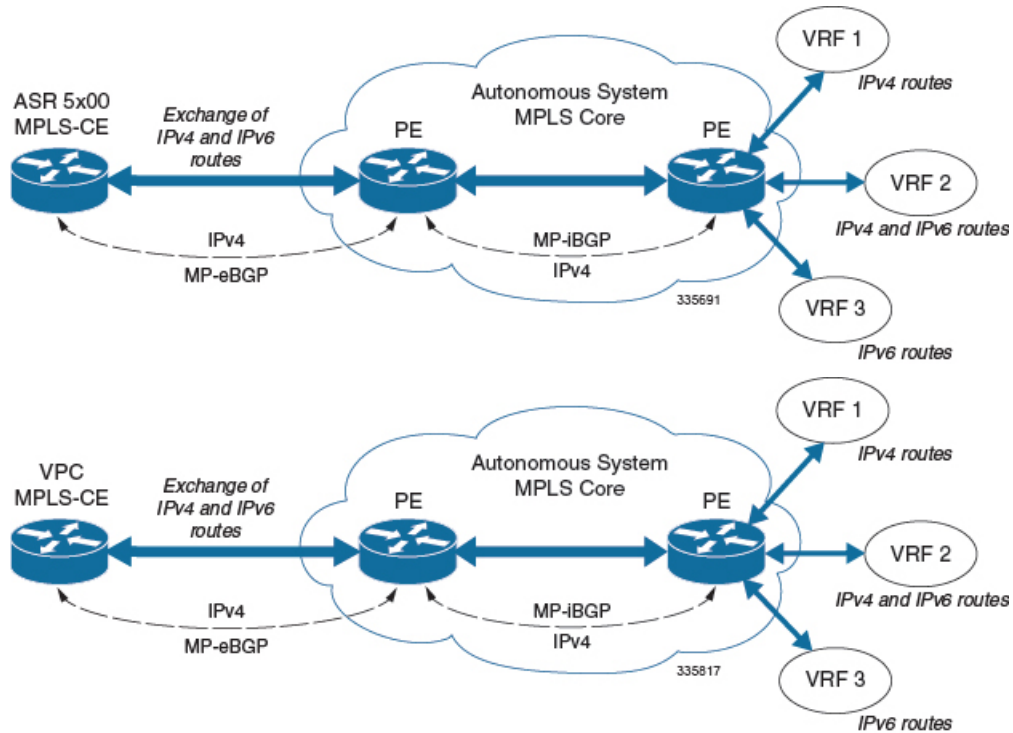

Configure VRFs.

```
ip vrf vrf1
exit
ip vrf vrf2
exit
ip vrf vrf3
exit
```

Enable MPLS BGP forwarding.

```
mpls bgp forwarding
```

Configure pools.

```
ip pool vrf1-pool 209.165.200.230 255.255.255.224 private 0 vrf vrf1
exit
ip pool vrf2-pool 209.165.200.230 255.255.255.224 private 0 vrf vrf2
exit
ipv6 pool vrf2-v6pool prefix 2005:0101::/32 private 0 vrf vrf2
exit
ipv6 pool vrf3-v6pool prefix 2005:0101::/32 private 0 vrf vrf3
exit
```

Configure interfaces.

```
interface ce_interface_to_rtr
ip address 209.165.200.226 255.255.255.224
exit
interface ce_v6_interface
ip address 2009:0101:0101:0101::1/96
exit
interface ce_loopback loopback
ip address 209.165.200.227 255.255.255.255
```

```

exit
interface vrf1-loop loopback
  ip vrf forwarding vrf1
  ip address 209.165.200.228 255.255.255.255
exit
interface vrf2-loop loopback
  ip vrf forwarding vrf2
  ip address 209.165.200.229 255.255.255.255
exit
interface vrf2-v6loop loopback
  ip vrf forwarding vrf2
  ip address 2005:0202:0101::1/128
exit
interface vrf3-v6loop loopback
  ip vrf forwarding vrf3
  ip address 2005:0303:0101::1/128
exit

```

Configure BGP along with address families and redistribution rules.

```

router bgp 800
  router-id 209.165.200.225
neighbor 209.165.200.240 remote-as 1003
  neighbor 209.165.200.240 activate
address-family vpnv4
  neighbor 209.165.200.240 activate
  neighbor 209.165.200.240 send-community both
exit
address-family vpnv6
  neighbor 209.165.200.240 activate
  neighbor 209.165.200.240 send-community both
exit
ip vrf vrf1
  route-distinguisher 800 1
  route-target export 800 1
  route-target import 800 1
exit
address-family ipv4 vrf vrf1
  redistribute connected
  redistribute static
exit
ip vrf vrf2
  route-distinguisher 800 2
  route-target export 800 2
  route-target import 800 2
exit
address-family ipv4 vrf vrf2
  redistribute connected
  redistribute static
exit
address-family ipv6 vrf vrf2
  redistribute connected
  redistribute static
exit
ip vrf vrf3
  route-distinguisher 800 3
  route-target export 800 3
  route-target import 800 3
exit
address-family ipv6 vrf vrf3
  redistribute connected
  redistribute static
exit

```

Configure APNs.

```

apn walmart51.com
  selection-mode sent-by-ms
  accounting-mode none
  aaa group walmart-group
  authentication pap 1 chap 2 allow-noauth
  ip context-name Gi_ce
  ip address pool name vrf1-pool
exit
apn amazon51.com
  selection-mode sent-by-ms
  accounting-mode none
  aaa group amazon-group
  authentication pap 1 chap 2 allow-noauth
  ip context-name Gi_ce
  ip address pool name vrf2-pool
  ipv6 address prefix-pool vrf2-v6pool
exit
apn apple51.com
  selection-mode sent-by-ms
  accounting-mode none
  aaa group apple-group
  authentication pap 1 chap 2 allow-noauth ip context-name Gi_ce
  ipv6 address prefix-pool vrf3-v6pool
exit
aaa-group amazon-group
  radius ip vrf vrf2
aaa group default
exit
gtp group default
exit
ip igmp profile default
exit

```

Bind physical interfaces with the port.

VPN-Related CLI Commands

VPN-related features and functions are supported across several CLI command modes. The following tables identify commands associated with configuration and monitoring of VPN-related functions.

Table 30: VPN-Related Configuration Commands

CLI Mode	Command	Description
BGP Address-Family (IPv4/IPv6) Configuration Mode	neighbor ip_address activate	Enables the exchange of routing information with a peer router.
BGP Address-Family (IPv4/IPv6) Configuration Mode	neighbor ip_address send community { both extended standard }	Sends the community attributes to a peer router (neighbor).
BGP Address-Family (IPv4/IPv6) Configuration Mode	redistribute connected	Redistributes routes into BGP from another protocol as BGP neighbors.
BGP Address-Family (VPNv4) Configuration Mode	neighbor ip_address activate	Enables the exchange of routing information with a peer router.

CLI Mode	Command	Description
BGP Address-Family (VPNv4) Configuration Mode	neighbor <i>ip_address</i> send community { both extended standard }	Sends the extended-community attribute to a peer router. In VPN, route-distinguisher and route-target are encoded in the BGP extended-community. This command enables sending of BGP routes with extended community to a neighbor.
BGP Address-Family (VRF) Configuration Mode	neighbor <i>ip_address</i> activate	Enables the exchange of routing information with a peer router.
BGP Address-Family (VRF) Configuration Mode	neighbor <i>ip_address</i> send community { both extended standard }	Sends the extended-community attribute to a peer router. In VPN, route-distinguisher and route-target are encoded in the BGP extended-community. This command enables sending of BGP routes with extended community to a neighbor.
BGP Address-Family (VRF) Configuration Mode	redistribute connected	Redistributes routes into BGP from another protocol as BGP neighbors.
BGP Configuration Mode	address-family { ipv4 vrf <i>vrf_name</i> vpn4 }	Enables the exchange of IPv4 VRF routing information. There is a different mode for each address-family.
BGP Configuration Mode	address-family { ipv6 vrf <i>vrf_name</i> vpn6 }	Configures a VPNv6 address family and IPv6 VRF routing in BGP.
BGP Configuration Mode	ip vrf <i>vrf_name</i>	Adds a VRF to BGP and switches to the VRF Configuration mode to allow configuration of BGP attributes for the VRF.
BGP IP VRF Configuration Mode	route-distinguisher { <i>as_value</i> <i>ip_address</i> } <i>rd_value</i>	Assigns a Route Distinguisher (RD) for the VRF. The RD value must be a unique value on the router for each VRF.
BGP IP VRF Configuration Mode	route-target { both import export } { <i>as_value</i> <i>ip_address</i> } <i>rt_value</i>	Adds a list of import and export route-target extended communities to the VRF.

CLI Mode	Command	Description
Context Configuration Mode	ip pool <i>pool_name</i> <i>addr_range</i> vrf <i>vrf_name</i> [mpls-label input <i>inlabel1</i> output <i>outlabel1 outlabel2</i>]	Configures a pool into the specified VRF. This parameter must be specified with the Next-Hop parameter. <i>inlabel1</i> is the MPLS label that identifies inbound traffic destined for this pool. <i>outlabel1</i> and <i>outlabel2</i> specify the MPLS labels to be added to packets sent for subscribers from this pool.
Context Configuration Mode	ip vrf <i>vrf_name</i>	Creates a VRF and assigns a VRF-ID. A VRF is created in the router.
Context Configuration Mode	ipv6 pool <i>pool_name</i> vrf <i>vrf_name</i>	Associates the pool with that VRF. Note: By default the configured ipv6 pool will be associated with the global routing domain.
Context Configuration Mode	mpls bgp forwarding	Globally enables MPLS Border Gateway Protocol (BGP) forwarding.
Context Configuration Mode	mpls exp <i>value</i>	Sets the default behavior as Best Effort using a zero value in the 3-bit MPLS EXP header. This value applies to all the VRFs in the context. The default behavior is to copy the DSCP value of mobile subscriber traffic to the EXP header, if there is no explicit configuration for DSCP to EXP (via the mpls map-dscp-to-exp dscp n exp m command). mpls exp disables the default behavior and sets the EXP value to the configured <i>value</i> .
Context Configuration Mode	mpls ip	Globally enables the MPLS forwarding of IPv4 packets along normally routed paths.
Context Configuration Mode	radius change-authorize-nas-ip <i>ip_address ip_address</i> { encrypted key } <i>value</i> port <i>port_num</i> mpls input <i>inlabel</i> output <i>outlabel1 outlabel2</i>	Configures COA traffic to use the specified MPLS labels. <i>inlabel</i> identifies inbound COA traffic. <i>outlabel1</i> and <i>outlabel2</i> specify the MPLS labels to be added to the COA response. <i>outlabel1</i> is the inner output label; <i>outlabel2</i> is the outer output label.
Ethernet Interface Configuration Mode	mpls ip	Enables dynamic MPLS forwarding of IP packets on this interface.

CLI Mode	Command	Description
Exec Mode	clear ip bgp peer	Clears BGP sessions.
Exec Mode	lsp-ping <i>ip_prefix_FEC</i>	Checks MPLS Label-Switched Path (LSP) connectivity for the specified forwarding equivalence class (FEC). It must be followed by an IPv4 or IPv6 FEC prefix.
Exec Mode	lsp-traceroute <i>ip_prefix_FEC</i>	Discovers MPLS LSP routes that packets actually take when traveling to their destinations. It must be followed by an IPv4 or IPv6 FEC prefix.
IP VRF Context Configuration Mode	mpls map-dscp-to-exp dscp <i>dscp_bit_value</i> exp <i>exp_bit_value</i>	Maps the final differentiated services code point (DSCP) bit value in the IP packet header to the final Experimental (EXP) bit value in the MPLS header for incoming traffic.
IP VRF Context Configuration Mode	mpls map-exp-to-dscp exp <i>exp_bit_value</i> dscp <i>dscp_bit_value</i>	Maps the incoming EXP bit value in the MPLS header to the internal DSCP bit value in IP packet headers for outgoing traffic.
MPLS-IP Configuration Mode	protocol ldp	Creates the MPLS protocol family configuration modes, or configures an existing protocol and enters the MPLS-LDP Configuration Mode in the current context. This command configures the protocol parameters for the MPLS protocol family.
MPLS-LDP Configuration Mode	advertise-labels { explicit-null implicit-null }	Configure advertisement of Implicit NULL or Explicit NULL label for all the prefixes advertised by the system in this context.
MPLS-LDP Configuration Mode	discovery { hello { hello-interval <i>seconds</i> hold-interval <i>seconds</i> } transport-address <i>ip_address</i> }	Configures the Label Distribution Protocol (LDP) neighbor discovery parameters.
MPLS-LDP Configuration Mode	enable	Enables Label Distribution Protocol (LDP).
MPLS-LDP Configuration Mode	router-id <i>ip_address</i>	Configures the LDP Router ID.
MPLS-LDP Configuration Mode	session timers { hold-interval <i>seconds</i> keepalive-interval <i>seconds</i> }	Configures the LDP session parameters.

Table 31: VPN-Related Monitoring Commands

CLI Mode	Command	Description
Exec Mode show Commands	show ip bgp neighbors	Displays information regarding BGP neighbors.
Exec Mode show Commands	show ip bgp vpnv4 { all route-distinguisher vrf }	Displays all VPNv4 routing data, routing data for a VRF or a route-distinguisher.
Exec Mode show Commands	show ip bgp vpnv6	Displays contents of VPNv6 routing table.
Exec Mode show Commands	show ip bgp vpnv6 { all route-distinguisher vrf }	Displays all VPNv6 routing data, routing data for a VRF or a route-distinguisher.
Exec Mode show Commands	show ip pool	Displays pool details including the configured VRF.
Exec Mode show Commands	show mpls cross-connect	Displays MPLS cross-connect information. MPLS tunnel cross-connects between interfaces and Label-Switched Paths (LSPs) connect two distant interface circuits of the same type via MPLS tunnels that use LSPs as the conduit.
Exec Mode show Commands	show mpls ftm [vrf vrf_name	Displays MPLS FEC-to-NHLFE (FTN) table information.
Exec Mode show Commands	show mpls ftm [vrf vrf_name]	Displays contents of the MPLS FTN table for a specified VRF.
Exec Mode show Commands	show mpls ilm	Displays MPLS Incoming Label Map (ILM) table information.
Exec Mode show Commands	show mpls ldp	Displays the MPLS LDP information.
Exec Mode show Commands	show mpls nexthop-label-forwarding-entry	Displays MPLS Next-Hop Label Forwarding Entry (NHLFE) table information.

Monitoring and Troubleshooting

This section provides information regarding the CLI command to monitor and troubleshoot the feature.

Show Commands and Outputs

This section provides information regarding show commands and their outputs in support of this feature.

show mpls fn vpp

The output of this CLI command contains the following new field for the MPLS Support on VPC-SI for CUPS feature:

- vpp
 - all-vrf
 - summary
 - vrf



Note

This new field enables viewing of the VPP dataplane values that are configured in the VPP dataplane forwarder. This show command is used for debugging along with the existing debug commands.

show mpls fn vpp



CHAPTER 51

Multiple Control Plane Support on User Plane

- [Revision History, on page 413](#)
- [Feature Description, on page 413](#)
- [How it Works, on page 414](#)
- [Configuring Multiple Control Plane Support on User Plane, on page 416](#)
- [Monitoring and Troubleshooting, on page 417](#)
- [Sample RCM Configuration, on page 422](#)

Revision History



Note Revision history details are not provided for features introduced before release 21.24.

Revision Details	Release
With this release, the feature is enhanced to support connection of upto eight CPs with a single UP.	21.26
With this release, the feature is enhanced to support connection of upto five CPs with a single UP.	21.25
First introduced.	Pre 21.24

Feature Description

In releases prior to 21.19.1, the CUPS architecture supported only a single Sx interface between User Plane (UP) and Control Plane (CP). In 21.19.1 and later releases, this feature enables single UP to establish multiple Sx interfaces to multiple CPs. Multiple Sx peers in a CP group are configured on UP to establish multiple Sx associations between a single UP and multiple CPs.

When Multiple CPs are connected to single UP, it allows a subscriber to connect to UP using any of the available CP. One of the primary use case of Multiple Sx feature is Active-Active redundancy. Even though it does not offer redundancy, as the calls are not recovered, multiple Sx allows the UPs connected to one CP

to be still accessible in case of a CP failure. If a CP fails, the calls serviced by that CP are lost. When they re-attach, the calls are routed to other available CPs which reuses the same UP pool.

In 21.20 and later releases, the feature supports configuration of same APN, and all related configuration, across multiple CPs so that the subscriber can attach using any of the available CP.

The Sx IP pool update message contains the CP address to enable UP VPNMgr to distinguish between routes installed from various CPs.



Note

- Both CP and UP are separately configured.
- Instead of a PFD push, the Redundancy and Configuration Management (RCM) pushes the configuration on UP.
- It's recommended not to configure more than four CP peer IP addresses in a single CP group.

How it Works

To configure multiple CPs with different Active Charging System (ACS) service, this feature leverages Redundancy and Configuration Management (RCM) functionality to push a super-set of configuration to UP.

Prerequisites

The following prerequisites must be met to configure multiple CPs:

- **Ruledef:**

UP provides UE service with different rule definition (Ruledef) configurations on multiple CPs under the same ACS (ECS) service. However, the Ruledef with the same name on different CPs must be common. For example, the following table shows Ruledef configurations on multiple CPs.

CP1	CP2	CP3	CP4
Rule_def 1	Rule_def 1	Rule_def 2	Rule_def 2
Rule_def 3	Rule_def 4	Rule_def 5	Rule_def 6

- **Group-of-Ruledefs (GoR):**

UP provides UE service with different Group-of-Ruledefs (GoR) configurations on multiple CPs under the same ACS (ECS) service. However, the GoR with the same name on different CPs must be common. For example, the following table shows GoR configurations on multiple CPs.

CP1	CP2	CP3	CP4
GoR 1	GoR 1	GoR 2	GoR 2
GoR 3	GoR 4	GoR 5	GoR 6

- **Rulebase:**

UP provides UE service with different Rulebase (RB) configurations on multiple CPs under the same ACS (ECS) service. However, the rulebase with the same name on different CPs must be common. For example, the following table shows Rulebase configurations on multiple CPs.

CP1	CP2	CP3	CP4
RB 1	RB 1	RB 2	RB 2
RB 3	RB 4	RB 5	RB 6

- **IP Pools:**

Each CP must be configured with mutually exclusive IP pools. This is to ensure that the unique IP address is assigned to subscriber when subscribers with same APN are serviced by different CPs. For example, the following table shows IP Pool configurations on multiple CPs.

CP1	CP2	CP3	CP4
Pool 1	Pool 2	Pool 3	Pool 4

Each CP pushes IP Pool configuration to UP during Sx Association procedure.

UP1	UP2
Pool 1	Pool 1
Pool 2	Pool 2
Pool 3	Pool 3
Pool 4	Pool 4

- **APN:**

UP provides UE service with different APN definition configurations on multiple CPs. However, the APN definition with the same name on different CPs, must be common and they should point to the same egress context. For example, the following table shows APN configurations on multiple CPs.

CP1	CP2	CP3	CP4
APN 1	APN 1	APN 2	APN 2
APN 3	APN 4	APN 5	APN 6

- **Egress Context**

Each CP must be configured with same context name which is configured as egress context for APNs configured in that CP. UP must be configured with all the egress context present on different CPs, to push the IP pools from CP to specific egress context on UP. For example, the following table shows egress context configurations on multiple CPs.

CP1	CP2	CP3	CP4
ISP1	ISP1	ISP1	ISP1

For example, the following table shows egress context configurations on multiple UPs.

UP1	UP2
ISP1	ISP1

The following image shows a sample RCM configuration of two CPs communicating with two UPs.

Figure 30: Sample RCM Configuration of Two CPs Communicating with Two UPs

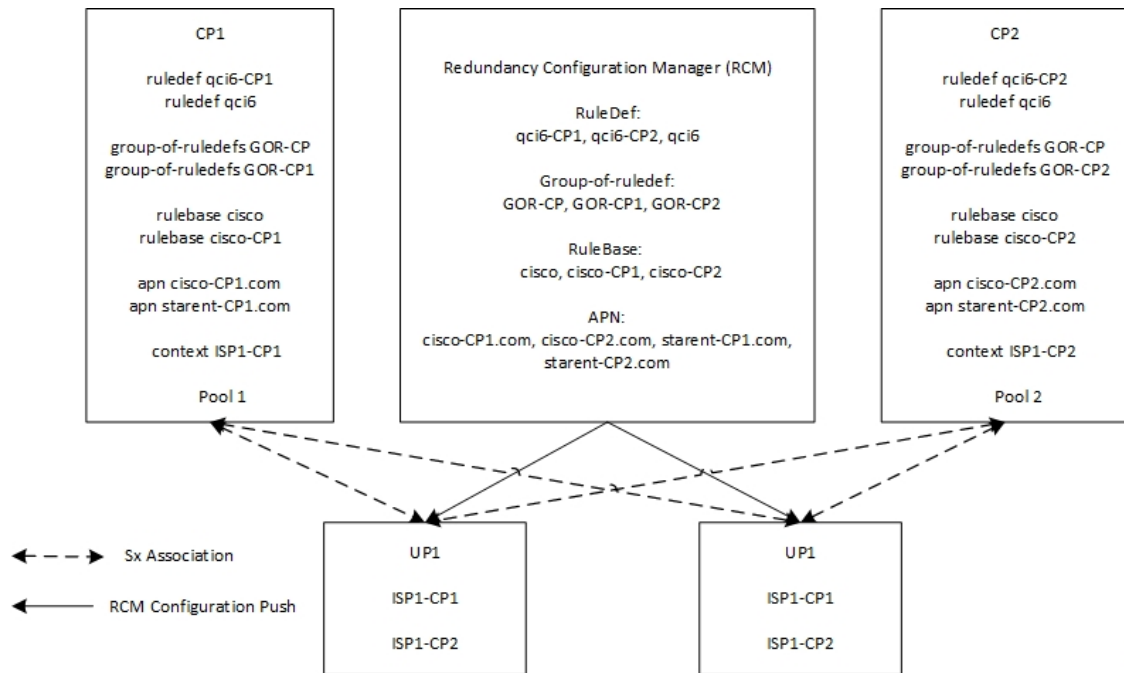

447182

Configuring Multiple Control Plane Support on User Plane

This section provides information about CLI commands that are available in support of this feature.

Disabling PFD Configuration Push from CP

As configuration push to UP is done through RCM, use the following CLI commands to disable PFD configuration push from CP.

```

configure
  user-plane-group group_name
    sx-pfd-push disabled
  end

```

Configuring Multiple CP on UP

Use the following CLI commands to configure multiple CP on UP by adding multiple peer node under Control Plane Group Configuration mode.

```

configure
  control-plane-group group_name
    peer-node-id ipv4-address ipv4_address
    peer-node-id ipv4-address ipv4_address
  end

```

Monitoring and Troubleshooting

This section provides information about monitoring and troubleshooting the Multiple CP Support on UP feature.

Show Commands and/or Outputs

This section describes the show commands that are available in support of this feature.

show sx-service statistics address <ip_address>

Use this command to display Sx statistics for a CP node. The following is a sample output:

```

Session Management Messages:
Session Establishment Request:
  Total TX:                0    Total RX:                2
  Initial TX:              0    Initial RX:              2
  Retrans TX:              0    Retrans RX:              0
  Discarded:               0
  No Rsp RX:               0
  Throttled:               0

Session Establishment Response:
  Total TX:                2    Total RX:                0
  Initial TX:              2    Initial RX:              0
  Accepted:                2    Accepted:                0
  Denied:                  0    Denied:                  0
  Retrans TX:              0    Discarded:               0

Session Modification Request:
  Total TX:                0    Total RX:                10
  Initial TX:              0    Initial RX:              10
  Retrans TX:              0    Retrans RX:              0
  Discarded:               0    Intf Type Mismatch:     0
  No Rsp RX:               0

Session Modification Response:
  Total TX:                10   Total RX:                0
  Initial TX:              10   Initial RX:              0
  Accepted:                10   Accepted:                0
  Denied:                  0    Denied:                  0
  Retrans TX:              0    Discarded:               0

Session Deletion Request:
  Total TX:                0    Total RX:                2
  Initial TX:              0    Initial RX:              2
  Retrans TX:              0    Retrans RX:              0
  Discarded:               0
  No Rsp RX:               0

Session Deletion Response:
  Total TX:                2    Total RX:                0
  Accepted:                2    Accepted:                0
  Denied:                  0    Denied:                  0
  Discarded:               0

Session Report Request:
  Total TX:                3    Total RX:                0
  Initial TX:              3    Initial RX:              0

```

```
show sx-service statistics address <ip_address>
```

```

Retrans TX:                0   Retrans RX:                0
Discarded:                 0
No Rsp RX:                 0

Session Report Response:
Total TX:                   0   Total RX:                   3
Initial TX:                 0   Initial RX:                 3
Accepted:                   0   Accepted:                   3
Denied:                     0   Denied:                     0
Retrans TX:                 0   Discarded:                  0

Node Management Messages:
Prime PFD Management Request:
Total TX:                   0   Total RX:                   0
Initial TX:                 0   Initial RX:                 0
Retrans TX:                 0   Retrans RX:                 0
No Rsp received TX:        0   Discarded:                  0

Prime PFD Management Response:
Total TX:                   0   Total RX:                   0
Initial TX:                 0   Initial RX:                 0
Accepted:                   0   Accepted:                   0
Denied:                     0   Denied:                     0
Retrans TX:                 0   Discarded:                  0

Association Setup Request:
Total TX:                   1   Total RX:                   0
Initial TX:                 1   Initial RX:                 0
Retrans TX:                 0   Retrans RX:                 0
No Rsp received TX:        0   Discarded:                  0

Association Setup Response:
Total TX:                   0   Total RX:                   1
Initial TX:                 0   Initial RX:                 1
Accepted:                   0   Accepted:                   1
Denied:                     0   Denied:                     0
Retrans TX:                 0   Discarded:                  0

Association Update Request:
Total TX:                   0   Total RX:                   3
Initial TX:                 0   Initial RX:                 3
Retrans TX:                 0   Retrans RX:                 0
No Rsp received TX:        0   Discarded:                  0

Association Update Response:
Total TX:                   3   Total RX:                   0
Initial TX:                 3   Initial RX:                 0
Accepted:                   3   Accepted:                   0
Denied:                     0   Denied:                     0
Retrans TX:                 0   Discarded:                  0

Association Release Request:
Total TX:                   0   Total RX:                   0
Initial TX:                 0   Initial RX:                 0
Retrans TX:                 0   Retrans RX:                 0
No Rsp received TX:        0   Discarded:                  0

Association Release Response:
Total TX:                   0   Total RX:                   0
Initial TX:                 0   Initial RX:                 0
Accepted:                   0   Accepted:                   0
Denied:                     0   Denied:                     0
Retrans TX:                 0   Discarded:                  0

```



```

Node Report Request:
  Total TX:                0    Total RX:                0
  Initial TX:              0    Initial RX:              0
  Retrans TX:              0    Retrans RX:              0
  No Rsp received TX:     0    Discarded:               0

Node Report Response:
  Total TX:                0    Total RX:                0
  Initial TX:              0    Initial RX:              0
  Accepted:                0    Accepted:                0
  Denied:                  0    Denied:                  0
  Retrans TX:              0    Discarded:               0

Heartbeat Request:
  Total TX:                1398  Total RX:                1398
  Initial TX:              1398  Initial RX:              1398
  Retrans TX:                0

Heartbeat Response:
  Total TX:                1398  Total RX:                1398

Stats framework related messages:
Stats Query Request:
  Total TX:                0    Total RX:                0
  Initial TX:              0    Initial RX:              0
  Retrans TX:              0    Retrans RX:              0
  No Rsp received TX:     0    Discarded:               0

Stats Query Response:
  Total TX:                0    Total RX:                0
  Initial TX:              0    Initial RX:              0
  Accepted:                0    Accepted:                0
  Denied:                  0    Denied:                  0
  Retrans TX:              0    Discarded:               0

Stats Query Acknowledgement:
  Total TX:                0    Total RX:                0
  Initial TX:              0    Initial RX:              0
  Retrans TX:              0    Retrans RX:              0
  Discarded:               0

Total Signalling Packets:
  TX:                      21          RX:                      21

Total Signalling Bytes:
  TX:                      2092         RX:                      5381

```

Use the **clear sx-service statistics address ip_address** CLI command to clear Sx statistics for a CP node.

show user-plane-service statistics peer-address <ip_address>

Use this command to display the node-level service statistics for a UP. The following is a sample output:

```

Peer IP                : 209.165.200.225

Subscribers Total:
PDNs Total:
Active:                1          Setup:                1
Released:              0          Rejected:              0

PDNs By PDN-Type:
IPv4 PDNs:
Active:                1          Setup:                1
Released:              0

```

```
show user-plane-service statistics peer-address <ip_address>
```

```

IPv6 PDNs:
Active:                0          Setup:                0
Released:             0

IPv4v6 PDNs:
Active:                0          Setup:                0
Released:             0

eMPS PDNs Total:
Active:                0          Setup:                0
Released:             0          Rejected:            1

PDNs By interface-Type:
Sxa interface-type PDNs:
Active:                0          Setup:                0
Released:             0

Sxb interface-type PDNs:
Active:                1          Setup:                1
Released:             0

Sxab interface-type PDNs:
Active:                0          Setup:                0
Released:             0

N4 interface-type PDNs:
Active:                0          Setup:                0
Released:             0

PDNs Rejected By Reason:
No Resource:          0          Missing or unknown APN: 0
Addr not alloc:      0          Addr not present:      0
No memory available: 0          System Failure:        0
Rule install failed: 0          SFW policy mismatch:   0

PDNs Released By Reason:
Network initiated release: 0          Admin disconnect:      0

Total Data Statistics:
Uplink :
Total Pkts:           0          Downlink :
Total Bytes:          0          Total Pkts:            0
Total Dropped Pkts:  0          Total Bytes:           0
Total Dropped Bytes: 0          Total Dropped Pkts:   0
Total Dropped Bytes: 0          Total Dropped Bytes:  0

Data Statistics Per PDN-Type:
IPv4 PDNs:
Uplink :
Total Pkts:           0          Downlink :
Total Bytes:          0          Total Pkts:            0
Total Bytes:          0          Total Bytes:           0

IPv6 PDN Data Statistics:
Uplink :
Total Pkts:           0          Downlink :
Total Bytes:          0          Total Pkts:            0
Total Bytes:          0          Total Bytes:           0

IPv4v6 PDN Data Statistics:
Uplink :
Total Pkts v4:        0          Downlink :
Total Bytes v4:       0          Total Pkts v4:         0
Total Pkts v6:        0          Total Bytes v4:        0
Total Bytes v6:        0          Total Pkts v6:         0
Total Bytes v6:        0          Total Bytes v6:         0

```

Use the **clear user-plane-service statistics peer-address ip_address** CLI command to clear the node-level service statistics for a UP.

show ip chunks peer <ip_address>

Use this command to display per CP IPv4 pool chunks at UP. The following is a sample output.

```

=====
Peer Address: 1.0.0.1
=====
|-----|-----|-----|-----|-----|
| chunk-id | chunk-size |         vrf-name         | start-addr | end-addr |
| used-addr |            |                           |             |           |
|-----|-----|-----|-----|-----|
| 1048576 | 1024 |           | 192.0.2.1 | 192.0.2.2 |
| 0 |      |           |           |           |
| 1048577 | 1024 |           | 192.0.2.3 | 192.0.2.4 |
| 0 |      |           |           |           |
| 1048578 | 1024 |           | 192.0.2.5 | 192.0.2.6 |
| 0 |      |           |           |           |
| 3145728 | 1024 | vrf1 | 192.0.2.7 | 192.0.2.8 |
| 0 |      |           |           |           |
| 3145729 | 1024 | vrf1 | 192.0.2.9 | 192.0.2.10 |
| 0 |      |           |           |           |
| 3145730 | 1024 | vrf1 | 192.0.2.11 | 192.0.2.12 |
| 0 |      |           |           |           |
| 4194304 | 1024 |           | 192.0.2.13 | 192.0.2.14 |
| 0 |      |           |           |           |
| 4194305 | 1024 |           | 192.0.2.15 | 192.0.2.16 |
| 0 |      |           |           |           |
| 4194306 | 1024 |           | 192.0.2.17 | 192.0.2.18 |
| 0 |      |           |           |           |
|-----|-----|-----|-----|-----|

```

show ipv6 chunks peer <ip_address>

Use this command to display per CP IPv6 pool chunks at UP. The following is a sample output.

```

=====
Peer Address: 1.0.0.101
=====
|-----|-----|-----|-----|-----|
| chunk-id | chunk-size |         vrf-name         | start-prefix | end-prefix |
| used-prefixes |            |                           |               |             |
|-----|-----|-----|-----|-----|
| 2098200576 | 1024 |           | 3001:: | 3001:0:0:3ff:: |
| 0 |      |           |         |                 |
| 2098200577 | 1024 |           | 3001:0:0:400:: | 3001:0:0:7ff:: |
| 0 |      |           |         |                 |
| 2098200578 | 1024 |           | 3001:0:0:800:: | 3001:0:0:bff:: |
| 0 |      |           |         |                 |
| 2099249152 | 1024 | vrf1 | 4001:: | 4001:0:0:3ff:: |
| 0 |      |           |         |                 |
| 2099249153 | 1024 | vrf1 | 4001:0:0:400:: | 4001:0:0:7ff:: |
| 0 |      |           |         |                 |
| 2099249154 | 1024 | vrf1 | 4001:0:0:800:: | 4001:0:0:bff:: |
| 0 |      |           |         |                 |
|-----|-----|-----|-----|-----|

```

Sample RCM Configuration

The following is a sample RCM configuration to configure the feature.

```

configure
etcd replicas 1
endpoint rcm-chkptmgr
  replicas 7
  vip-ip 209.165.200.225
exit
endpoint rcm-configmgr
  vip-ip 209.165.200.225
exit
endpoint rcm-bfdmgr
  vip-ip 209.165.200.226
exit
endpoint rcm-controller
  vip-ip 209.165.200.225
exit
logging level application trace
logging level transaction trace
logging level tracing off
logging name infra.config.core level application trace
logging name infra.config.core level transaction trace
logging name infra.resource_monitor.core level application debug
logging name infra.resource_monitor.core level transaction debug
k8 smf profile rcm-config-ep disable-cm apn gtpv creditCtrl packetFilter urrList ruledef
rulebase miscacs global chargingAction upfCpg upSvcv sxService gtpuService upfIfc
lawfulIntercept apnprofile
k8 smf profile rcm-bfd-ep bfd-monitor group 1
  endpoint ipv4 209.165.200.227
  endpoint ipv4 209.165.200.228
  endpoint ipv4 209.165.200.229
  standby 1
exit
system mode running
helm default-repository smf
helm repository smf
  access-token
dev-deployer.gen:AKCp5ekcXA7TknM9DbLASNBw4jwVEsx9Z9WpQwEvCvCQ2mJhLymcz6BfbH38YJiWC6fnlcKmw
url http://example.com
exit
k8s name          unknown
k8s namespace     rcm
k8s nf-name       rcm
k8s registry      dockerhub.xxx.com/smi-fuse-docker-internal
k8s single-node   false
k8s use-volume-claims false
k8s ingress-host-name 209.165.200.225.nip.io
profile smf rcm
  node-id 123456
exit
svc-type upinterface
svc-type sxsvc
svc-type upsvc
svc-type gtpusvc
svc-type cpgrp
  redundancy-group 1
  host 209.165.200.225:22
host 295 "config "
host 296 "control-plane-group CPGROUP21 "
host 297 "peer-node-id ipv4-address 209.165.200.230 "
```

```

host 298 "peer-node-id ipv4-address 209.165.200.231 "
host 299 "exit "
host 300 "end "
exit
exit
svc-type sxsvc
svc-type upsvc
svc-type gtpusvc
svc-type cpgrp
  redundancy-group 1
    host 209.165.200.225:22
host 393 " config "
host 394 "control-plane-group CPGROUP21 "
host 395 "peer-node-id ipv4-address 209.165.200.230 "
host 396 "peer-node-id ipv4-address 209.165.200.231 "
host 397 "48 exit "
host 398 "49 end "
exit
exit
exit
redundancy-group 1
common 1 " sleep 5 "
common 2 " config "
common 3 " active-charging service ACS "
common 4 " #exit "
common 5 " ruledef ipv6 "
common 6 " icmpv6 any-match = TRUE "
common 7 " #exit "
common 8 " ruledef qci1 "
common 9 " tcp src-port = 1001 "
common 10 " #exit "
common 11 " ruledef qci2 "
common 12 " tcp src-port = 1002 "
common 13 " #exit "
common 14 " ruledef qci6 "
common 15 " tcp src-port = 1006 "
common 16 " #exit "
common 17 " ruledef qci6-CP1 "
common 18 " udp src-port = 1010 "
common 19 " #exit "
common 20 " ruledef qci6-CP2 "
common 21 " udp src-port = 1020 "
common 22 " #exit "
common 23 " group-of-ruledefs GOR "
common 24 " add-ruledef priority 11 ruledef qci1 "
common 25 " add-ruledef priority 22 ruledef qci2 "
common 26 " add-ruledef priority 33 ruledef ipv6 "
common 27 " #exit "
common 28 " group-of-ruledefs GOR-CP1 "
common 29 " add-ruledef priority 11 ruledef qci1 "
common 30 " add-ruledef priority 33 ruledef ipv6 "
common 31 " #exit "
common 32 " group-of-ruledefs GOR-CP2 "
common 33 " add-ruledef priority 11 ruledef qci2 "
common 34 " add-ruledef priority 33 ruledef ipv6 "
common 35 " #exit "
common 36 " packet-filter ipv6 "
common 37 " ip protocol = 58 "
common 38 " priority 22 "
common 39 " #exit "
common 40 " packet-filter qci1 "
common 41 " ip protocol = 6 "
common 42 " ip remote-port = 1001 "
common 43 " priority 1 "

```

```

common 44 " #exit "
common 45 " packet-filter qci2 "
common 46 "   ip protocol = 6 "
common 47 "   ip remote-port = 1002 "
common 48 "   priority 2 "
common 49 " #exit "
common 50 " packet-filter qci6 "
common 51 "   ip protocol = 6 "
common 52 "   ip remote-port = 1006 "
common 53 "   priority 6 "
common 54 " #exit "
common 55 " packet-filter qci6-CP1 "
common 56 "   ip protocol = 17 "
common 57 "   ip remote-port = 1010 "
common 58 "   priority 1 "
common 59 " #exit "
common 60 " packet-filter qci6-CP2 "
common 61 "   ip protocol = 17 "
common 62 "   ip remote-port = 1020 "
common 63 "   priority 1 "
common 64 " #exit "
common 65 " urr-list URR_ID_LIST "
common 66 "   rating-group 1 urr-id 1 "
common 67 "   rating-group 2 urr-id 2 "
common 68 "   rating-group 3 urr-id 3 "
common 69 "   rating-group 4 urr-id 4 "
common 70 "   rating-group 5 urr-id 5 "
common 71 "   rating-group 6 urr-id 6 "
common 72 "   rating-group 7 urr-id 7 "
common 73 "   rating-group 8 urr-id 8 "
common 74 "   rating-group 9 urr-id 9 "
common 75 "   rating-group 10 urr-id 10 "
common 76 "   rating-group 11 urr-id 11 "
common 77 "   rating-group 12 urr-id 12 "
common 78 "   rating-group 13 urr-id 13 "
common 79 "   rating-group 14 urr-id 14 "
common 80 " #exit "
common 81 " charging-action ipv6 "
common 82 "   content-id 11 "
common 83 "   billing-action egcdr "
common 84 "   billing-action rf "
common 85 "   cca charging credit rating-group 11 "
common 86 "   qos-class-identifier 5 "
common 87 "   flow limit-for-bandwidth id 2 "
common 88 "   tft packet-filter ipv6 "
common 89 " #exit "
common 90 " charging-action qcil "
common 91 "   content-id 1 "
common 92 "   billing-action egcdr "
common 93 "   billing-action rf "
common 94 "   cca charging credit rating-group 1 "
common 95 "   qos-class-identifier 1 "
common 96 "   flow limit-for-bandwidth id 1 "
common 97 "   allocation-retention-priority 1 pvi 0 pci 1 "
common 98 "   tft packet-filter qcil "
common 99 " #exit "
common 100 " charging-action qcil-GOR "
common 101 "   content-id 1 "
common 102 "   billing-action egcdr "
common 103 "   billing-action rf "
common 104 "   cca charging credit rating-group 1 "
common 105 "   qos-class-identifier 1 "
common 106 "   flow limit-for-bandwidth id 1 "
common 107 "   allocation-retention-priority 1 pvi 0 pci 1 "

```

```

common 108 "      tft packet-filter ipv6 "
common 109 "      tft packet-filter qci1 "
common 110 "      tft packet-filter qci2 "
common 111 "      #exit "
common 112 "      charging-action qci1-GOR-CP1 "
common 113 "          content-id 1 "
common 114 "          billing-action egcdr "
common 115 "          billing-action rf "
common 116 "          cca charging credit rating-group 1 "
common 117 "          qos-class-identifier 1 "
common 118 "          flow limit-for-bandwidth id 1 "
common 119 "          allocation-retention-priority 1 pvi 0 pci 1 "
common 120 "      tft packet-filter ipv6 "
common 121 "      tft packet-filter qci1 "
common 122 "      #exit "
common 123 "      charging-action qci1-GOR-CP2 "
common 124 "          content-id 1 "
common 125 "          billing-action egcdr "
common 126 "          billing-action rf "
common 127 "          cca charging credit rating-group 1 "
common 128 "          qos-class-identifier 1 "
common 129 "          flow limit-for-bandwidth id 1 "
common 130 "          allocation-retention-priority 1 pvi 0 pci 1 "
common 131 "      tft packet-filter ipv6 "
common 132 "      tft packet-filter qci2 "
common 133 "      #exit "
common 134 "      charging-action qci2 "
common 135 "          content-id 2 "
common 136 "          billing-action egcdr "
common 137 "          billing-action rf "
common 138 "          cca charging credit rating-group 2 "
common 139 "          qos-class-identifier 2 "
common 140 "          flow limit-for-bandwidth id 1 "
common 141 "          allocation-retention-priority 2 pvi 0 pci 1 "
common 142 "          tft packet-filter qci2 "
common 143 "      #exit "
common 144 "      charging-action qci6 "
common 145 "          content-id 6 "
common 146 "          billing-action egcdr "
common 147 "          billing-action rf "
common 148 "          cca charging credit rating-group 6 "
common 149 "          qos-class-identifier 6 "
common 150 "          flow limit-for-bandwidth id 2 "
common 151 "          allocation-retention-priority 6 pvi 0 pci 1 "
common 152 "          tft packet-filter qci6 "
common 153 "      #exit "
common 154 "      charging-action qci6-CP1 "
common 155 "          content-id 12 "
common 156 "          billing-action egcdr "
common 157 "          billing-action rf "
common 158 "          cca charging credit rating-group 12 "
common 159 "          qos-class-identifier 6 "
common 160 "          flow limit-for-bandwidth id 2 "
common 161 "          allocation-retention-priority 6 pvi 0 pci 1 "
common 162 "          tft packet-filter qci6-CP1 "
common 163 "      #exit "
common 164 "      charging-action qci6-CP2 "
common 165 "          content-id 13 "
common 166 "          billing-action egcdr "
common 167 "          billing-action rf "
common 168 "          cca charging credit rating-group 13 "
common 169 "          qos-class-identifier 6 "
common 170 "          flow limit-for-bandwidth id 2 "
common 171 "          allocation-retention-priority 6 pvi 0 pci 1 "

```

```

common 172 "      tft packet-filter qci6-CP2 "
common 173 "      #exit "
common 174 "      bandwidth-policy bw_policy1 "
common 175 "      flow limit-for-bandwidth id 1 group-id 1 "
common 176 "      flow limit-for-bandwidth id 2 group-id 2 "
common 177 "      group-id 1 direction downlink peak-data-rate 256000 peak-burst-size
768000 violate-action discard committed-data-rate 128000 committed-burst-size 384000 "
common 178 "      group-id 1 direction uplink peak-data-rate 256000 peak-burst-size 768000
violate-action discard committed-data-rate 128000 committed-burst-size 384000 "
common 179 "      group-id 2 direction downlink peak-data-rate 256000 peak-burst-size
768000 violate-action discard "
common 180 "      group-id 2 direction uplink peak-data-rate 256000 peak-burst-size 768000
violate-action discard "
common 181 "      #exit "
common 182 "      rulebase cisco "
common 183 "      billing-records egcdr "
common 184 "      action priority 1 dynamic-only group-of-ruledefs GOR charging-action
qci1-GOR "
common 185 "      action priority 11 dynamic-only ruledef qci1 charging-action qci1 "
common 186 "      action priority 22 dynamic-only ruledef qci2 charging-action qci2 "
common 187 "      action priority 66 dynamic-only ruledef qci6 charging-action qci6 "
common 188 "      action priority 666 dynamic-only ruledef ipv6 charging-action ipv6 "
common 189 "      egcdr threshold interval 3600 "
common 190 "      egcdr threshold volume total 100000 "
common 191 "      bandwidth default-policy bw_policy1 "
common 192 "      #exit "
common 193 "      rulebase cisco-CP1 "
common 194 "      billing-records egcdr "
common 195 "      action priority 1 dynamic-only group-of-ruledefs GOR-CP1 charging-action
qci1-GOR-CP1 "
common 196 "      action priority 11 dynamic-only ruledef qci1 charging-action qci1 "
common 197 "      action priority 22 dynamic-only ruledef qci2 charging-action qci2 "
common 198 "      action priority 66 dynamic-only ruledef qci6-CP1 charging-action qci6-CP1
"
common 199 "      action priority 666 dynamic-only ruledef ipv6 charging-action ipv6 "
common 200 "      egcdr threshold interval 1000 "
common 201 "      egcdr threshold volume total 100000 "
common 202 "      bandwidth default-policy bw_policy1 "
common 203 "      #exit "
common 204 "      rulebase cisco-CP2 "
common 205 "      billing-records egcdr "
common 206 "      action priority 1 dynamic-only group-of-ruledefs GOR-CP2 charging-action
qci1-GOR-CP2 "
common 207 "      action priority 11 dynamic-only ruledef qci1 charging-action qci1 "
common 208 "      action priority 22 dynamic-only ruledef qci2 charging-action qci2 "
common 209 "      action priority 66 dynamic-only ruledef qci6-CP2 charging-action qci6-CP2
"
common 210 "      action priority 666 dynamic-only ruledef ipv6 charging-action ipv6 "
common 211 "      egcdr threshold interval 1000 "
common 212 "      egcdr threshold volume total 100000 "
common 213 "      bandwidth default-policy bw_policy1 "
common 214 "      #exit "
common 215 "      rulebase default "
common 216 "      #exit "
common 217 "      credit-control group default "
common 218 "      diameter origin endpoint PGW-Gy "
common 219 "      diameter peer-select peer PGW-Gy-server "
common 220 "      quota time-threshold 10 "
common 221 "      diameter pending-timeout 150 deciseconds msg-type any "
common 222 "      diameter session failover "
common 223 "      trigger type rat qos sgsn serving-node "
common 224 "      pending-traffic-treatment noquota pass "
common 225 "      pending-traffic-treatment quota-exhausted buffer "
common 226 "      timestamp-rounding floor "

```



```
common 227 "      #exit "  
common 228 "      traffic-optimization-policy default "  
common 229 "      #exit "  
common 230 "      #exit "  
common 231 " end "  
common 232 " config "  
common 233 " context ISP1-CP1 "  
common 234 "     apn xxx-CP1.com "  
common 235 "         ip context-name ISP1-CP1 "  
common 236 "     exit "  
common 237 "     apn yyy-CP1.com "  
common 238 "         ip context-name ISP1-CP1 "  
common 239 "     exit "  
common 240 " end "  
common 241 " config "  
common 242 " context ISP1-CP2 "  
common 243 "     apn xxx-CP2.com "  
common 244 "         ip context-name ISP1-CP2 "  
common 245 "     exit "  
common 246 "     apn yyy-CP2.com "  
common 247 "         ip context-name ISP1-CP2 "  
common 248 "     exit "  
common 249 " end "  
exit
```



CHAPTER 52

MOCN Special Handling of CRA and CNR

- [Revision History](#), on page 429
- [Feature Description](#), on page 429
- [TAI Change Event Handling](#), on page 430
- [How It Works](#), on page 431

Revision History



Note Revision history details are not provided for features introduced before release 21.24.

Revision Details	Release
First introduced	Pre 21.24

Feature Description

This feature describes the SAE-GW support to enable/disable the Multi Operator Core Network (MOCN). The feature also explains about the handling of Tracking Areas Identity (TAI) change event as requested by PCRF when MOCN is enabled.

The SAE-GW indicates the MME to Start/Stop reporting TAI change event as requested by PCRF. On receiving a TAI change from MME, the SAE-GW reports:

- The TAI change event to PCRF
- The location update to OCS

The following figure describes about the MOCN feature that allows different core network operators to connect to a shared radio access network.

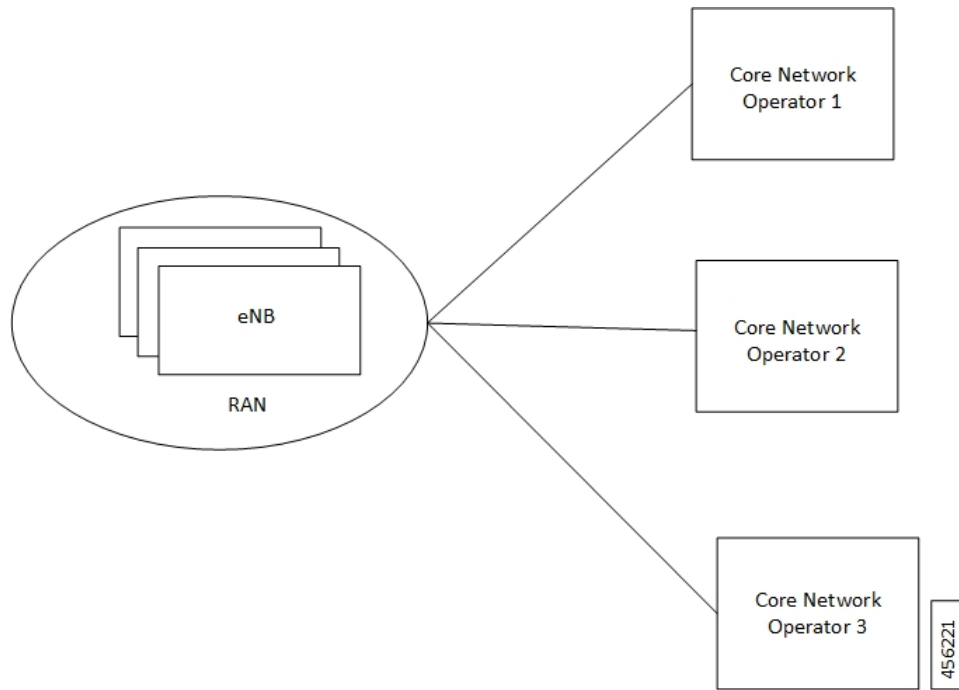

TAI Change Event Handling

The following figure describes the high-level overview of the architecture of TAI change event handling.

Figure 31: TAI Change Event Handling - Process Flow

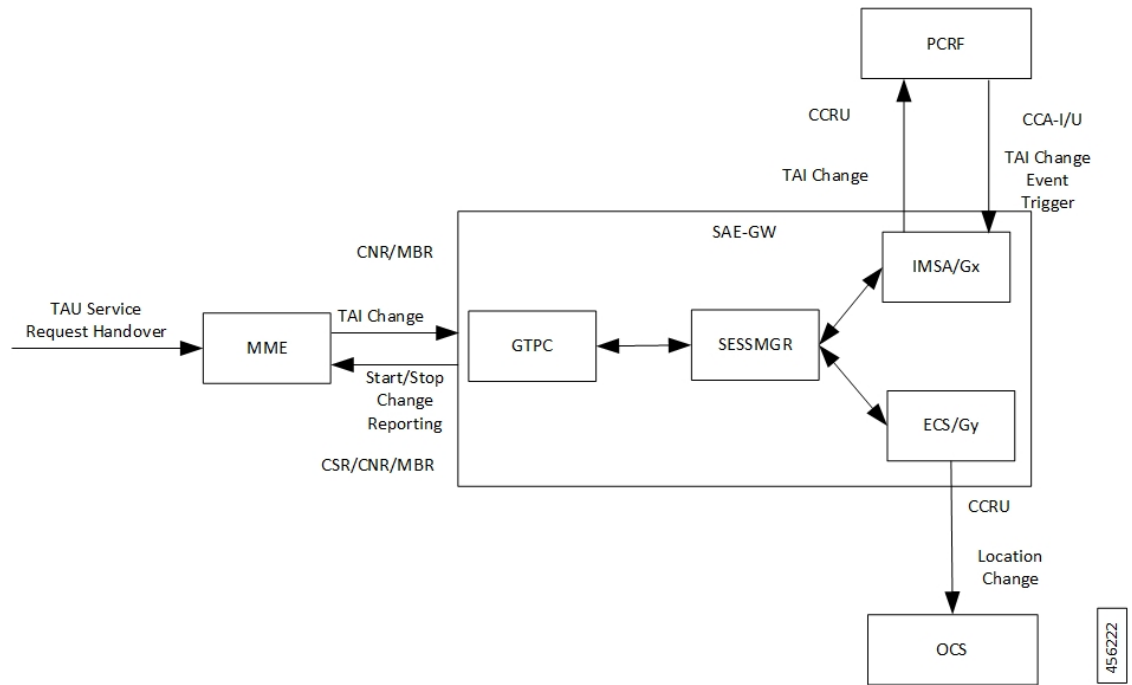

When you enable the MOCN feature on SAE-GW and it receives a TAI change trigger from PCRF in event trigger AVP of Credit Control Answer-Initial/Update (CCA-I/U), the SAE-GW sends a start reporting TAI indication to MME in Change Reporting Action (CRA) of Create Session Response/Modify Bearer Request/Change Notification Response.

The MME sends the TAI change in User Location Information of Change Notification Request/Modify Bearer Request to SAE-GW in the event of TAI change during various procedures like Tracking Area Update (TAU), Service Request and S1AP/X2 handover.

In turn, the SAE-GW indicates the TAI change to the PCRF in Event Trigger AVP and the value in 3GPP-User-Location-Info AVP of Credit Control Request-Update (CCR-U) to receive any location-dependent policies.

The SAE-GW also indicates the Location change to OCS in Trigger Type AVP and User Location Info in PS-Information AVP and Multiple Services Credit Control (MSCC) to enable location-dependent charging related procedures.

When you enable the MOCN feature on SAE-GW and it receives a No Event Trigger from PCRF in event trigger AVP of Credit Control Answer-Initial/Update (CCA-I/U), the SAE-GW sends a Stop Reporting TAI indication to MME in Change Reporting Action (CRA) of Create Session Response/Modify Bearer Request/Change Notification Response.

How It Works

The following call flows describe about the starting and stopping of the TAI change report.

Start Reporting TAI Change

The following call flow describes about the reporting of the TAI change.

Stop Reporting TAI Change

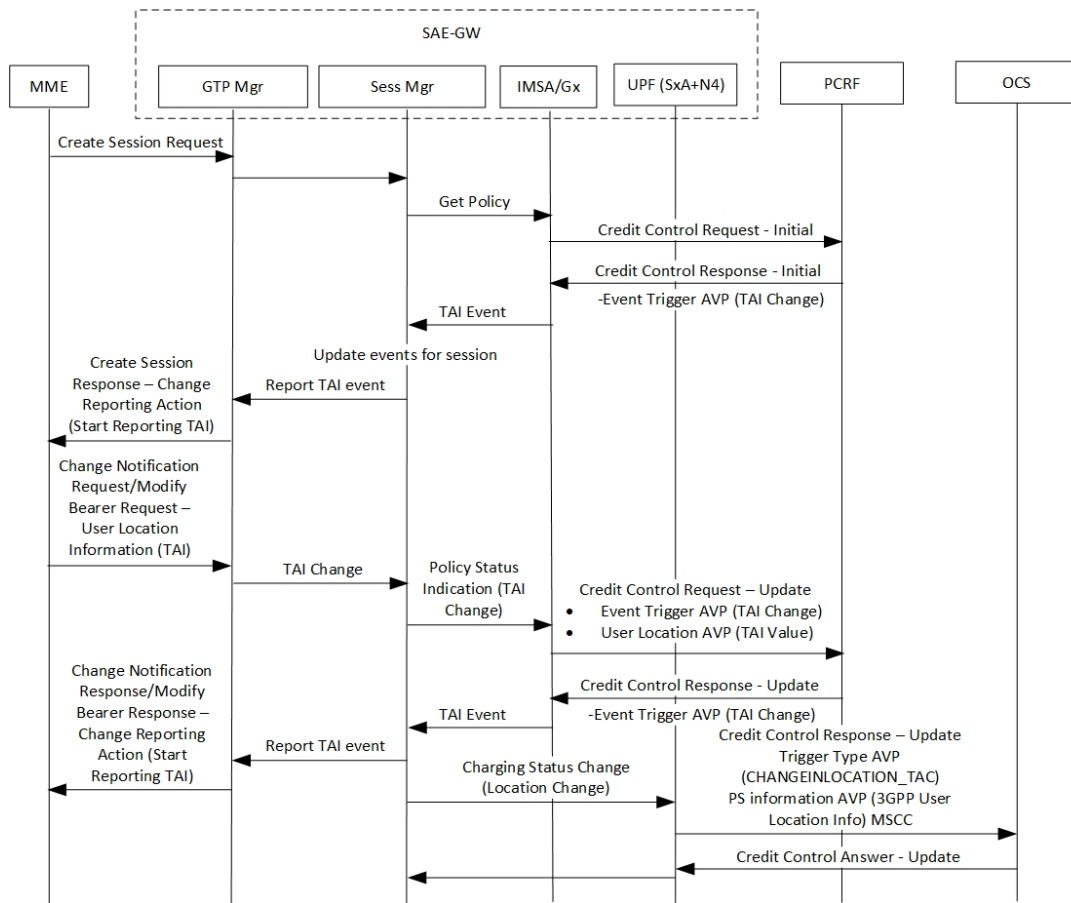

456223

Steps	Description
1.	During the session establishment procedure, the SAE-GW sends the Create Session Response to MME with Change Reporting Action (CRA) value set to Start Reporting TAI if the PCRF requests for TAI change reporting by specifying Event Trigger set to TAI_CHANGE (26) in CCA-I to SAE-GW.
2.	The MME on detecting change in UE's TAI sends Change Notification Request or Modify Bearer Request with ULI including new TAI. The SAE-GW includes the Event-Trigger set as TAI_CHANGE (26) in CCR-U sent to PCRF and the value in User Location AVP. If the SAE-GW receives CCA-U with Event-Trigger set to TAI_CHANGE (26) from PCRF, the SAE-GW sends the Change Notification Response or Modify Bearer Response with CRA value set to Start Reporting TAI.
3.	Then the SAE-GW includes the Trigger-Type AVP with CHANGEINLOCATION_TAC (35), PS-Information AVP (3GPP-User-Location: new TAI) and MSCC in CCR-U sent to OCS and receives CCA-U from OCS.

Stop Reporting TAI Change

The following call flow describes about the reporting of the TAI change.

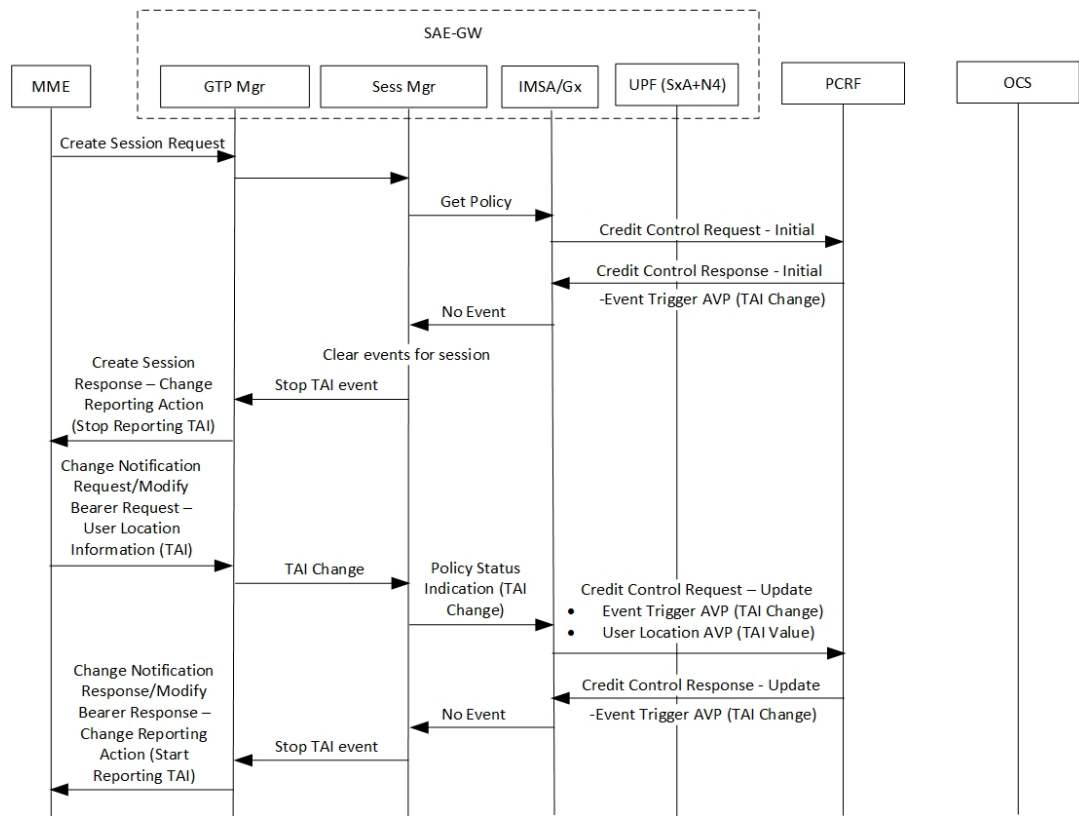

45672A

During the session establishment procedure, the SAE-GW sends the Create Session Response to MME with Change Reporting Action (CRA) value set to Stop Reporting TAI if the PCRF requests for no event reporting by specifying Event Trigger set to NO_EVENT_TRIGGERS in CCA-I to SAE-GW.

Stop Reporting TAI Change



CHAPTER 53

NAT Support

- [Feature Summary and Revision History, on page 435](#)
- [Feature Description, on page 435](#)
- [Configuring NAT in CUPS, on page 437](#)
- [Monitoring and Troubleshooting, on page 439](#)

Feature Summary and Revision History

Revision History



Note Revision history details are not provided for features introduced before release 21.24.

Revision Details	Release
With this release clarification for firewall NAT port release behaviour change in CUPS UP is provided.	21.27.x
First introduced.	Pre 21.24

Feature Description

CUPS supports Network Address Translation (NAT) which allows you to configure network addresses. The system can be configured to automatically forward data packets encapsulating the source IP or Source port address of the UE with NAT IP address and NAT port.

The supported NAT combinations include:

- NAT44 On Demand Many to One
- NAT44 On Demand One to One
- NAT64 On Demand Many to One
- NAT 64 On Demand One to One

- NAT44 Not On Demand Many to One
- NAT44 Not On Demand One to One
- NAT64 Not On Demand Many to One
- NAT64 Not On Demand One to One

For supplemental information about NAT, see *StarOS NAT Administration Guide*.

NOTE: Not all features and/or functionality that are mentioned in *StarOS NAT Administration Guide* are applicable in the CUPS architecture.

Behavior of NAT Port Release

The ICMP NAT port usage is higher in CUPS solutions than legacy due to the following reasons:

- In Legacy, on receiving the ICMP response, the NAT ports are released so that they can be used for the next message. In CUPS, the NAT ports are released only after the 100th ICMP message is received.
- In Legacy, if no ICMP response is received for the requests, then 20 NAT ports are allocated continuously and released starting from the first one. In CUPS, the deletion happens only after the 100th ICMP packet.

Limitations

NAT support has the following limitations:

- Only NAT44 with many-to-one and on-demand mode is supported.
- All NAT pools are configured at respective User Plane on destination context.
- Charging action with CLI action deny in fw-and-nat policy and for flow-any-error charging action in active-charging-service is not supported.
- Access-rules which are configured with "dynamic-only" and "static-and-dynamic" – rules from external servers are not supported.
- Multiple IP support from same realm is not supported with this feature.
- Next hop forwarding in NAT pool is not supported.
- Port range in NAT pool is not supported.
- Skip private IP check CLI is not supported.
- RADIUS and Gy returned Fw-and-nat policy-based applying NAT policy is not supported.
- Bearer specific filters are not supported in access-ruledefs.
- Access-rules do not support trigger open-port port range config in fw-and-nat policy.
- NAT port recovery (fw-and-nat action) is not supported after SR/ICSR.
- NAT Re-assembly Timeout CLI is not supported in active-charging service. The generic context level CLI on UP must be used instead.
- NAT fragmentation re-assembly failure is not supported due to open bugs in basic CUPS re-assembly.
- NAT flow-mapping timer is not supported

- For N:M redundancy, the NAT IP pools to be configured from RCM done as part of interface config for each UP host and the pool name needs to be unique across all the active User Planes. This makes it mandatory to use NAT Groups for all the pools so that the same NAT realm referred in fw-and-nat policy can be applicable for all the User Planes.
- In case of N:M redundancy, the total number of NAT IP pools collectively configured on all UPs via RCM must be as per the maximum limit (2000) of IP pools. The configuration in standby User Plane fails if the cumulative total of all active UPs exceeds the maximum value.

Configuring NAT in CUPS

The relevant configuration of NAT is done at CP and pushed to UP. Only pool-related configuration is present on User Plane.

For information on NAT-related CLI commands, refer to the *StarOS NAT Administration Guide > NAT Configuration* chapter.

NOTE: Not all CLI commands and configurations mentioned in the *StarOS NAT Administration Guide > NAT Configuration* chapter are applicable in CUPS architecture.

Sample Configurations

Control Plane

The following is a sample configuration required at Control Plane for enabling NAT in CUPS. This configuration is pushed to User Plane during User Plane registration through PFD mechanism.

```
configure
active-charging service ACS
  access-ruledef all
    ip any-match = TRUE
  #exit
  access-ruledef udp
    udp any-match = TRUE
  #exit
  access-ruledef tcp
    tcp any-match = TRUE
  #exit
  access-ruledef icmp
    icmp any-match = TRUE
  #exit
fw-and-nat policy NatPolicy1
  access-rule priority 1 access-ruledef tcp permit nat-realm NAT44_GRP1
  access-rule priority 2 access-ruledef icmp permit nat-realm NAT44_GRP1
  #access-rule priority 2 access-ruledef r2 permit bypass-nat
  nat policy ipv4-only default-nat-realm NAT44_PUBLIC5
  nat binding-record edr-format NBR port-chunk-allocation port-chunk-release
  #exit

fw-and-nat policy NatPolicy2
  access-rule priority 1 access-ruledef all permit nat-realm NAT44_PUBLIC1
  #access-rule priority 2 access-ruledef r2 permit bypass-nat
  nat policy ipv4-only
  nat binding-record edr-format NBR port-chunk-allocation port-chunk-release
  #exit
```

```

rulebase cisco
fw-and-nat default-policy NatPolicy1
flow end-condition normal-end-signaling session-end timeout edr NBR
#exit
#exit
end

```

User Plane

The following pool-related configuration is required at User Plane in ISP context.

```

configure
context ISP1-UP
ip pool NAT44_PUBLIC1 209.165.200.225 255.255.255.224 napt-users-per-ip-address 2
on-demand port-chunk-size 16 max-chunks-per-user 4 group-name NAT44_GRP1
ip pool NAT44_PUBLIC2 209.165.200.226 255.255.255.224 napt-users-per-ip-address 2
on-demand port-chunk-size 16 max-chunks-per-user 4 group-name NAT44_GRP1
ip pool NAT44_PUBLIC3 209.165.200.227 255.255.255.224 napt-users-per-ip-address 2
on-demand port-chunk-size 8 max-chunks-per-user 1 group-name NAT44_GRP2
ip pool NAT44_PUBLIC4 209.165.200.228 255.255.255.224 napt-users-per-ip-address 4
on-demand port-chunk-size 32256 max-chunks-per-user 4 group-name NAT44_GRP2
ip pool NAT44_PUBLIC5 209.165.200.229 255.255.255.224 napt-users-per-ip-address 8064
on-demand port-chunk-size 8 max-chunks-per-user 2
end

```

Sample NAT Pool Related Configuration for Different NAT Pool Types

```

1-1 on-demand:
-----
config
context ISP1-UP
ip pool NAT44_ipv4_1_1 209.165.200.230 255.255.255.224 nat-one-to-one on-demand
nat-binding-timer 60
end

N-1 Not-on-demand:
-----
config
context ISP1-UP
ip pool NAT44_ipv4_N_1 209.165.200.231 255.255.255.224 napt-users-per-ip-address 2
max-chunks-per-user 2 port-chunk-size 8
end

1-1 Not-on-demand:
-----
config
context ISP1-UP
ip pool NAT44_ipv4_NOD_1_1 209.165.200.232 255.255.255.224 nat-one-to-one
end

```



Note In Control Plane configuration needs to be added along with one or more access ruledef mapped to any of the required NAT Pool/Group configured in User Plane. For more information, see *Ultra Packet Core CUPS Control Plane Administration Guide*.

Monitoring and Troubleshooting

Gathering NAT Statistics

The following table lists the commands that can be used to gather NAT statistics.

The first column lists the statistics to gather and the second column lists the command to use.

Statistics/Information	Show Command
Information for all current subscribers who have either active or dormant sessions. Checks IP address associated with subscriber. Also displays all the IP addresses that are in use in a NAT realm.	show subscribers user-plane-only full all
Information on NAT subsystem statistics.	show user-plane-service statistics all
All NAT-related statistics.	show user-plane-service statistics nat all
All NAT Realm-related statistics.	show user-plane-service statistics nat nat-realm all
Statistics of all NAT IP pools in a NAT IP pool group.	show user-plane-service statistics nat nat-realm <i>pool_name</i>
Information on NAT bind records generated.	show user-plane-service edr-format statistics all
Verifying association of fw-and-nat policy in APN on UP.	show user-plane-service pdn-instance name <i>name</i>
Verifying configuration of fw-an-nat policy on UP.	show user-plane-service fw-and-nat policy all
Information on NAT bind records generated for port chunk allocation and release.	show user-plane-service rulebase name <i>name</i>
Information on access ruledef.	show user-plane-service ruledef all
Verifying association of fw-and-nat policy in rulebase on UP.	show user-plane-service rulebase name <i>name</i>

Clear Commands

The following clear CLI commands are available in support of this feature:

- **clear user-plane-service statistics nat nat-realm all**
- **clear user-plane-service statistics nat all**

SNMP Traps for NAT Parameter Thresholds

The following SNMP traps for NAT parameter thresholds are supported.

SNMP Traps	Description
ThreshNATPortChunks	Generated when NAT port chunk usage reaches configured threshold limit
ThreshClearNATPortChunks	Generated when NAT port chunk usage reaches configured clear threshold limit.
ThreshNATPktDrop	Generated when NAT packet drop reaches configured threshold limit.
ThreshClearNATPktDrop	Generated when NAT packet drop reaches configured clear threshold limit.
ThreshIPPoolUsed	Generated when the number of IPs used in the IP Pool reaches configured threshold limit.
ThreshClearIPPoolUsed	Generated when the number of IPs used in the IP Pool reaches configured clear threshold limit.
ThreshIPPoolFree	Generated when IP pool is free and threshold limit reached.
ThreshClearIPPoolFree	Generated when IP pool is used, and clear threshold limit reached.
ThreshIPPoolAvail	Generated when IP pool is available for next flow and configured threshold reached.
ThreshClearIPPoolAvail	Generated when IP pool is used, and configured threshold is reached.

NOTE: The respective CLIs must be configured in the User Plane to enable these traps.

Bulk Statistics

Context Schema

Table 32: Context Schema

Variable Name	Data Type	Counter Type	Description
nat-total-flows	Int64	Counter	Total number of NAT44 and NAT64 flows
nat44-total-flows	Int64	Counter	Total number of NAT44 flows
nat64-total-flows	Int64	Counter	Total number of NAT64 flows
bypass-nat-total-flows	Int64	Counter	Total number of NAT44 and NAT64 Bypass NAT flows
bypass-nat-ipv4-total-flows	Int64	Counter	Total number of NAT44 Bypass NAT flows
bypass-nat-ipv6-total-flows	Int64	Counter	Total number of NAT64 Bypass NAT flows
nat-current-flows	Int64	Gauge	Current number of NAT44 and NAT64 flows

Variable Name	Data Type	Counter Type	Description
nat44-current-flows	Int64	Gauge	Current number of NAT44 flows
nat64-current-flows	Int64	Gauge	Current number of NAT64 flows
bypass-nat-current-flows	Int64	Gauge	Current number of NAT44 and NAT64 Bypass NAT flows
bypass-nat-ipv4-current-flows	Int64	Gauge	Current number of NAT44 Bypass NAT flows
bypass-nat-ipv6-current-flows	Int64	Gauge	Current number of NAT64 Bypass NAT flows
sfw-total-rxpackets	Int64	Counter	Total number of packets received by the Service
sfw-total-rxbytes	Int64	Counter	Total number of bytes received by the Service
sfw-total-txpackets	Int64	Counter	Total number of packets transferred by the Service
sfw-total-txbytes	Int64	Counter	Total number of bytes transferred by the Service
sfw-total-injectedpkts	Int64	Counter	Total number of packets injected by the Service
sfw-total-injectedbytes	Int64	Counter	Total number of bytes injected by the Service
sfw-dnlnk-droppkts	Int64	Counter	Total number of downlink packets dropped by the Service
sfw-dnlnk-dropbytes	Int64	Counter	Total number of downlink bytes dropped by the Service
sfw-uplnk-droppkts	Int64	Counter	Total number of uplink packets dropped by the Service
sfw-uplnk-dropbytes	Int64	Counter	Total number of uplink bytes dropped by the Service



Note Schema is supported in User Plane for CUPS.

ECS Schema

Table 33: ECS Schema

Variable Name	Data Type	Counter Type	Description
nat-current-ipv4-pdn-subscribers	Int32	Gauge	Current number of NAT IPv4 PDN Subscribers
nat-current-ipv6-pdn-subscribers	Int32	Gauge	Current number of NAT IPv6 PDN Subscribers
nat-current-ipv4v6-pdn-subscribers	Int32	Gauge	Current number of NAT IPv4v6 PDN Subscribers
nat-total-ipv4-pdn-subscribers	Int64	Counter	Total number of NAT IPv4 PDN Subscribers

Variable Name	Data Type	Counter Type	Description
nat-total-ipv6-pdn-subscribers	Int64	Counter	Total number of NAT IPv6 PDN Subscribers
nat-total-ipv4v6-pdn-subscribers	Int64	Counter	Total number of NAT IPv4v6 PDN Subscribers
nat-current-ipv4-pdn-subscribers-with-nat-ip	Int32	Gauge	Current number of NAT IPv4 PDN Subscribers with NAT IP
nat-current-ipv6-pdn-subscribers-with-nat-ip	Int32	Gauge	Current number of NAT IPv6 PDN Subscribers with NAT IP
nat-current-ipv4v6-pdn-subscribers-with-nat-ip	Int32	Gauge	Current number of NAT IPv4v6 PDN Subscribers with NAT IP
nat-total-ipv4-pdn-subscribers-with-nat-ip	Int64	Counter	Total number of NAT IPv4 PDN Subscribers with NAT IP
nat-total-ipv6-pdn-subscribers-with-nat-ip	Int64	Counter	Total number of NAT IPv6 PDN Subscribers with NAT IP
nat-total-ipv4v6-pdn-subscribers-with-nat-ip	Int64	Counter	Total number of NAT IPv4v6 PDN Subscribers with NAT IP
nat-total-unsolicited-dwnlnk-pkts	Int64	Counter	Total number of unsolicited downlink packets received
nat-total-icmp-hu-sent-for-dwnlnk-pkts	Int64	Counter	Total number of ICMP host unreachable sent for downlink packets



Note Schema is supported in User Plane for CUPS.

NAT-realm Schema

The NAT realms are configured in User Plane and statistics are stored per-context per-realm. These statistic variables, both cumulative and snapshot, are available in the nat-realm schema.

Table 34: NAT-realm Schema

Variable Name	Data Type	Counter Type	Description
Vpnname	String	Info	Context name.
Realmname	String	Info	Realm name.
nat-rlm-bind-updates	Int64	Counter	Total interim AAA NBU sent.
nat-rlm-bytes-txferred	Int64	Counter	Total number of NAT44 and NAT64 bytes transferred by realm (uplink + downlink).

Variable Name	Data Type	Counter Type	Description
nat-rlm-bytes-nat44-tx	Int64	Counter	Total number of NAT44 bytes transferred by realm.
nat-rlm-bytes-nat64-tx	Int64	Counter	Total number of NAT64 bytes transferred by realm.
nat-rlm-ip-flows	Int64	Counter	Total number of NAT44 and NAT64 flows used by the realm.
nat-rlm-nat44-flows	Int64	Counter	Total number of NAT44 flows processed by realm.
nat-rlm-nat64-flows	Int64	Counter	Total number of NAT64 flows processed by realm.
nat-rlm-ip-denied	Int32	Counter	Total number of NAT44 and NAT64 flows denied NAT IP address.
nat-rlm-ip-denied-nat44	Int64	Counter	Total number of NAT44 flows denied IP.
nat-rlm-ip-denied-nat64	Int64	Counter	Total number of NAT64 flows denied IP.
nat-rlm-port-denied	Int32	Counter	Total number of NAT44 and NAT64 flows denied ports.
nat-rlm-port-denied-nat44	Int64	Counter	Total number of NAT44 flows denied ports.
nat-rlm-port-denied-nat64	Int64	Counter	Total number of NAT64 flows denied ports.
nat-rlm-memory-denied	Int64	Counter	Total number of NAT44 and NAT64 flows denied memory.
nat-rlm-memory-denied-nat44	Int64	Counter	Total number of NAT44 flows denied memory.
nat-rlm-memory-denied-nat64	Int64	Counter	Total number of NAT64 flows denied memory.
nat-rlm-ttl-ips	Int32	Gauge	Total number of NAT public IP addresses, per context per NAT realm. Is a static value.
nat-rlm-ips-in-use	Int32	Gauge	Total number of NAT IP addresses currently in use, per context per NAT realm.
nat-rlm-current-users	Int32	Gauge	Total number of subscribers currently using the NAT realm.
nat-rlm-ttl-port-chunks	Int32	Gauge	Total number port-chunks, per context per NAT realm. Is a static value.
nat-rlm-chunks-in-use	Int32	Gauge	Total number of port-chunks currently in use, per context per NAT realm.

Variable Name	Data Type	Counter Type	Description
nat-rlm-port-chunk-size	Int32	Gauge	Size of the port chunk in the NAT realm.
nat-rlm-port-chunk-average-usage-tcp	Int32	Gauge	Average TCP port usage in the allocated TCP ports, i.e. out of allocated TCP ports how many got used. Not percentage value.
nat-rlm-port-chunk-average-usage-udp	Int32	Gauge	Average UDP port usage in the allocated UDP ports, i.e. out of allocated UDP ports how many got used. Not percentage value.
nat-rlm-port-chunk-average-usage-others	Int32	Gauge	Average other (ICMP or GRE) port usage in the allocated other ports, i.e. out of allocated 'other' ports how many got used. Not percentage value.
nat-rlm-max-port-chunk-subscribers	Int64	Counter	Total number of subscribers who used maximum number of port chunks.
nat-rlm-max-port-chunk-used	Int32	Counter	Maximum port chunks used.
nat-rlm-max-cur-port-chunk-subscribers	Int64	Gauge	Current number of subscribers using maximum number of port chunks.
nat-rlm-max-cur-port-chunk-used	Int32	Gauge	Maximum port chunks used by active subscribers.

EDRs

The following NAT-specific attributes are supported in regular EDRs:

- sn-nat-subscribers-per-ip-address: Subscriber(s) per NAT IP address
- sn-subscriber-nat-flow-ip: NAT IP address of NAT-enabled subscribers
- sn-subscriber-nat-flow-port: NAT port number of NAT-enabled subscribers

Sample EDR

```
#sn-start-time,sn-end-time,ip-protocol,ip-subscriber-ip-address,ip-server-ip-address,sn-subscriber-port,sn-server-port,
sn-nat-ip,sn-nat-port-block-start,sn-nat-port-block-end,sn-subscriber-nat-flow-ip,sn-subscriber-nat-flow-port,sn-nat-realm-name,
sn-nat-subscribers-per-ip-address,sn-nat-binding-timer,sn-nat-gtt-offset,sn-nat-port-chunk-alloc-dealloc-flag,sn-nat-port-chunk-alloc-time-gtt,
sn-nat-port-chunk-dealloc-time-gmt,sn-nat-no-port-packet-dropped,sn-closure-reason
02/18/2020 12:11:11:630,02/18/2020
12:11:11:632,1,209.165.200.225,209.165.201.1,0,0,,,,,209.165.200.230,1024,,2,,,,,0,0
02/18/2020 12:11:08:672,02/18/2020
12:11:09:671,6,209.165.200.225,209.165.201.1,1001,3000,,,,,209.165.200.230,1034,,2,,,,,0,0
02/18/2020 12:11:14:499,02/18/2020
12:11:14:499,17,209.165.200.225,209.165.201.1,1001,3000,,,,,209.165.200.240,1025,,8064,,,,,0,0
```

NAT Binding Records

Whenever a NAT IP address or NAT port-chunk is allocated/deallocated to/from a subscriber, NAT Binding Records (NBR) can be generated. Generation of NBRs is configurable in the Firewall-and-NAT policy configuration.

Sample NBR

```
#sn-start-time,sn-end-time,ip-protocol,ip-subscriber-ip-address,ip-server-ip-address,sn-subscriber-port,
sn-server-port,sn-nat-ip,sn-nat-port-block-start,sn-nat-port-block-end,sn-subscriber-nat-flow-ip,sn-subscriber-nat-flow-port,
sn-nat-realm-name,sn-nat-subscribers-per-ip-address,sn-nat-binding-timer,sn-nat-gmt-offset,sn-nat-port-chunk-alloc-dealloc-flag,
sn-nat-port-chunk-alloc-time-gmt,sn-nat-port-chunk-dealloc-time-gmt,sn-nat-no-port-packet-dropped,sn-closure-reason
,,,209.165.200.225,,,,209.165.201.1,1024,1039,,,NAT44_PUBLIC2,2,60,+0530,1,02/18/2020
06:41:08,,,
,,,209.165.200.225,,,,209.165.201.2,1024,1031,,,NAT44_PUBLIC5,8064,60,+0530,1,02/18/2020
06:41:14,,,
,,,209.165.200.225,,,,209.165.201.3,1024,1039,,,NAT44_PUBLIC2,2,60,+0530,0,02/18/2020
06:41:08,02/18/2020 06:42:12,,
,,,209.165.200.225,,,,209.165.201.14,1024,1031,,,NAT44_PUBLIC5,8064,60,+0530,0,02/18/2020
06:41:14,02/18/2020 06:44:24,,
```

Packet Drop EDR

Sample Packet Drop EDR

```
#sn-nat-no-port-packet-dropped,sn-start-time,sn-end-time,sn-subscriber-imsi
2,03/13/2020 08:28:24,03/13/2020 08:28:54,123456789012345
```



CHAPTER 54

NAT ALG Support

- [Feature Summary and Revision History, on page 447](#)
- [Feature Description, on page 447](#)
- [Components of Session Initiation Protocol ALG, on page 448](#)
- [How it Works, on page 450](#)
- [NAT FW Processing, on page 452](#)
- [Configuring NAT ALG, on page 453](#)
- [Monitoring and Troubleshooting, on page 458](#)

Feature Summary and Revision History

Revision History



Note Revision history details are not provided for features introduced before release 21.24.

Revision Details	Release
First introduced	Pre 21.24

Feature Description



Note This feature is not fully qualified in this release.

NAT performs translation service on any Transmission Control Protocol/User Datagram Protocol (TCP/UDP) traffic that doesn't carry source and/or destination IP addresses in application data stream. These protocols include:

- HTTP

- Trivial File Transfer Protocol (TFTP)
- Telnet
- Archie
- Finger
- Network Time Protocol (NTP)
- Network File System (NFS)
- Remote login (rlogin)
- Remote shell protocol (RSH)
- Remote copy protocol (RCP)

The following specific protocols have the IP address information within the payload. These protocols require the support of an Application Level Gateway (ALG) for translation services.

- FTP
- H323
- Session Initiation Protocol (SIP)
- Session Description Protocol (SDP)
- TFTP
- RTSP
- Point-to-Point Tunneling Protocol (PPTP)

Limitations

NAT64 to v4 translation for H323 is not supported.

Components of Session Initiation Protocol ALG

The following block diagram shows all the components that support SIP ALG for NAT or Firewall. The ALG-CORE and SIP APP are the new components. The other components are existing one which requires enhancements.



Note This example is specific to the SIP ALG, similar component is applicable for all other protocols in the document.

Figure 32: Components of Session Initiation Protocol (SIP) ALG

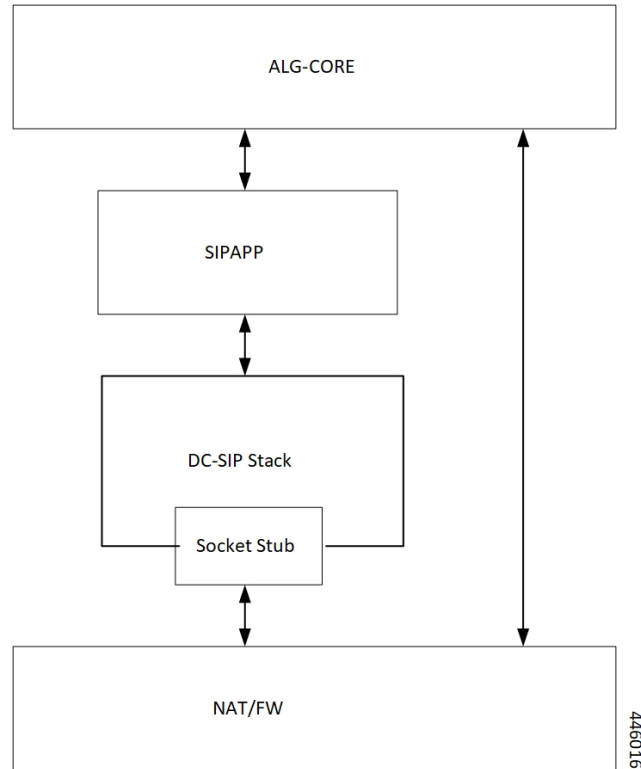

Table 35: Component and Functionality

Component	Function
ALG-CORE	<ul style="list-style-type: none"> • Interacts with the NAT/FW to create/modify/clear the pinholes. • ALG-CORE has the logic to store the pinhole information inside HA CLP. (defines a new pointer to structure called sip_alg_info). • ALG-CORE processes messages from SIPAPP based on the state and event it received.

Component	Function
SIP APP	<ul style="list-style-type: none"> • New functionality logic in each per request/response callback. • New data structures to maintain call/session related information's (based on stacks callCb/TransactionCb data structures). • Defines some generic UMM structures for sip/H.323, to interact with the ALG-CORE. • Do the encoding of the SIP message, that is private IP to public IP ...from the information returned by the ALG-CORE.
DC-SIP	<p>DC-SIP is a full-blown sip stack, which parses the sip messages, maintains the transactions and call states. For SIP-ALG functionality the DC-SIP acts as B2BUA. Following are the functionalities DC-SIP stack provides:</p> <ul style="list-style-type: none"> • Message parsing • Transaction management • Call management • Message encoding • Call back per request/response type.

The Socket Stub is the component that receives/sends packet from/to NAT/FW.

NAT/FW sends/receives the SIP packets to socket stub and it also provides the generic APIs to interact with ALG-CORE.

How it Works

Some of network applications exchanges the IP/Port information of server/client as part of payload. The server or client uses that exchanged IP/Port information to create new flows. As part of NAT ALGs, the server or client extracts that IP/Port info and allow those flows dynamically through pinholes.

In case of NAT, the server or client does the IP and transport level translations. The NAT IP and NAT Port replace the private source IP and source Port and conversely. But the sending application may not be aware of these translations since these translations are transparent.

For example, FTP NAT ALG function interprets the 'PORT' and 'PASV reply' messages. NAT translates the same in the payload so that the FTP happens transparently through the NAT.

NAT layer supports NAT 44 translation and NAT 64 translation. The NAT also supports 1:1 On demand NAT translation and Many:1 NAT translation.

Following are supported for each of the ALGs:

- NAT 44 1:1 On demand NAT translation
- NAT 44 Many:1 NAT translation
- NAT 64 1:1 On demand NAT translation
- NAT 64 Many:1 NAT translation

FTP

FTP is a TCP-based protocol and uses two flows one is for control messages another one for data/file transfer. FTP uses PORT and PASSIVE reply commands to exchange data flow parameters. These commands carry IP and Port information as part of the pay load.

RTSP

RTSP is a TC-based real time streaming protocol having different methods to control real-time media transfer. The control messages are having Port information embed, which is to transfer the media.

PPTP

Point-to-Point Tunneling Protocol (PPTP) allows the tunneling for Point to Point Protocol (PPP) through an IP network. PPTP uses an enhanced GRE (Generic Routing Encapsulation) to carry PPP packets. PPTP exchanges IP or port-specific information over its control connection and that information is to transfer the data over tunnel.

SIP

SIP is an application-layer control protocol. SIP can establish, modify, and terminate multimedia sessions (conferences) such as Internet telephony calls. SIP is based on a request/response transaction model. Each transaction consists of a request that invokes a method, or function, on the server and at least one response. These requests and responses have client and server IP and port information. The SDP message bodies for describing multimedia sessions (that maybe present in SIP requests and responses) also has the IP and port information embedded in them.

For the transmission of media streams (voice, video) the SDP payload carried in SIP messages typically employs the Real-time Transport Protocol (RTP). The SIP ALG intercepts all the SIP communication and translates the private IP and port in the payload to NAT IP and Port.

TFTP

Trivial File Transfer Protocol (TFTP) is an application layer protocol for File Transfers. Due to its simple mechanism, many Embedded Systems uses this protocol to download images or files from the server. It's a UDP-based protocol. TFTP L7 payload doesn't contain IP or Port information but requires the pinholes to allow the Downlink initiated data flow.

H323

H323 is a set of protocol specifications that can establish, modify, and terminate multimedia sessions such as Internet telephony calls. Protocols involved in successful multimedia session are RAS, H225, H245, and media protocols (RTP, RTCP). RAS protocol is for communication between H323 Gatekeeper and the terminal. This communication helps to locate the other terminal to which it wants to communicate. H225 and H245 communicates between the terminals for session establishment, capability exchange, and media parameters exchange. The H245 messages have the details of the media channel in which the multimedia communication is going to take place. IP and Port information is present in the RAS, H225 and H245 messages. H323 ALG intercepts all the H323 communication and translates the private IP and port in the payload to NAT IP and Port.

NAT FW Processing

After receiving the key for processing the packets, the ECS framework creates flows with 5-tuple:

- Source IP
- Source port
- Protocol
- Destination IP
- Destination port

If it's the first packet with a given 5-tuple, then a NAT/FW rule match applies to check if the packet is acceptable or not. If packet is acceptable, then leads to a flow is creation.

Configuration of the NAT realm (NAT IP) is part of the rules. The NAT realm applicable for a flow is from the rule-definition that matches the packet

Rule configuration happens are based on well-known server addresses/port numbers. For example, the FTP service with port 21, SIP service with port 5060.

So, any FTP control session or SIP control session to well-known servers/port numbers finds a matching firewall rule. However, it may not be possible to configure rules for media flows (child flows) that are dynamically based on the control signaling.

In case of FTP data or SIP media packet, the NAT/FW rule definition match fails and drops the packets.

Another requirement is the control signaling and the corresponding media connection to use the same NAT realm. Same NAT IP address applies for control and media.

Even if the child flow (media connection) finds a matching NAT/FW rule. The child flow uses the NAT realm configuration for that rule, which isn't correct. The media flows should be using the same NAT realm that is applicable for the control connection.

So, the child flows even if there's no matching rule uses the same NAT realm that was for the control connection. In order to achieve the flow, create the pinholes based on the signaling messages. A pinhole contains subset of 5-tuple information.

Pinholes are to allow the traffic without doing any rule match (bypass rule match). The NAT realm is associated with the pinholes. Allows any traffic matching the pinholes and the NAT realm specified in the pinhole applies for noting the packets.

In case of many-to-one NAT, the NAT allows the downlink packets only if there's an active NAT binding. There are many services (SIP for example) where the remote end wants to initiate connections (incoming call). Under such conditions, to allow downlink packets the ALG needs to create required NAT bindings and associate with the pinholes by parsing signaling messages.

Following explains the uplink and downlink packet processing:

Uplink Packet Processing

Refer to the following points for the uplink packet processing.

- On receiving any uplink packet, comparison takes place against existing 5-tuple flows.
- If a matching flow exists (5-tuple match), the NAT binding that is associated with the flow applies on the packet.
- If no flow exists, then a pinhole lookup happens to check if there are any pinholes opened for this flow.
- If pinhole exists, then the NAT binding associated with the pinhole applies on the packet.
- If no pinhole exists, then rule match determines the NAT information for that flow. If no matching rule exists, the packet drops.

In case of outgoing SIP requests, the SIP message associates with the destination port as 5060. So, configure a rule with destination port as 5060 for identifying SIP traffic. The corresponding NAT realm configured for the rule gets applied on the SIP request.

Any pin holes based on the requests should have NAT bindings associated with them. This NAT bindings allocation is from the NAT realm that was for processing the request.

Downlink Packet Processing

Refer to the following points for the uplink packet processing.

- The downlink packets pass only if an active NAT binding exists. If the binding-look up fails, then the packet drops.
- If the binding lookup succeeds, the packet undergoes initial flow match processing same as an uplink packet processing.
- However, in case of downlink packets, no rule match happens for a packet from on a many-to-one NAT IP. The packet passes only if there's matching flow or a matching pinhole otherwise it drops. If a pinhole exists, then the NAT binding with the pinhole applies on that flow.
- In case of one-to-one NAT, even if there's no pinhole, rule match happens, and packet passes if a matching rule is there. The NAT realm that receives the packet applies for that downlink flow.

Configuring NAT ALG

Following are the commands to configure the NAT ALG.

```
configure  
active-charging service acs_service_name
```

```

    firewall nat-alg { default | no } { ftp | pptp | rtsp | sip | h323
}
end

```

NOTES:

- **default:** Configures this command with the default setting for the specified parameter.
- **no:** Disables all/ or the specified NAT ALG configuration. When disabled, the ALG(s) will not do any payload translation for NAT calls.
- **ftp:** Enables/disables File Transfer Protocol (FTP) NAT ALG.
- **pptp:** Enables/disables Point-to-Point Tunneling Protocol (PPTP) NAT ALG.
- **rtsp:** Enables/disables Real Time Streaming Protocol (RTSP) ALG.
- **sip:** Enables/disables Session Initiation Protocol (SIP) NAT ALG.
- **h323:** Enables/disables H323 NAT ALG.

Configuration for Many to One and One to Many

Many to one configuration on the User Plane.

```
ip pool NAT44_PUBLIC4 209.165.200.225 255.255.255.224 napt-users-per-ip-address 4 group-name
NAT44_GRP2 on-demand max-chunks-per-user 4 port-chunk-size 32256
```

One to One configuration on the User Plane.

```
ip pool NAT44_PUBLIC4 209.165.200.225 255.255.255.224 nat-one-to-one on-demand group-name
NAT44_GRP1
```

Sample Configuration for FTP NAT ALG

In order to route the packets to the FTP ALG on Control Plane, Configure the following FTP routing rule.

```

Config
active-charging service acs
  ruledef rt_ftp-control
    tcp either-port = 21
    rule-application routing
    multi-line-or all-lines
  #exit
  ruledef rt_ftp-data
    tcp either-port = 20
    rule-application routing
    multi-line-or all-lines
  #exit
access-ruledef SFW_HTTP
  ip any-match = TRUE
  #exit
access-ruledef all
  ip any-match = TRUE
  #exit
access-ruledef ipv6_nat
  ip server-ipv6-network-prefix = 64:ff98::/96
  #exit
rulebase prepaid
  route priority 14 ruledef rt_ftp-data analyzer ftp-data
  route priority 15 ruledef rt_ftp-control analyzer ftp-control

```

```

#exit
fw-and-nat policy nat_policy1
  access-rule priority 1 access-ruledéf ipv6_nat permit nat-realm NAT44_GRP1
  access-rule priority 10 access-ruledéf SFW_HTTP permit nat-realm NAT44_GRP1
  access-rule priority 100 access-ruledéf all permit nat-realm NAT44_GRP1
  nat policy ipv4-and-ipv6
#exit
firewall nat-alg ftp ipv4-and-ipv6
#exit

```

Sample Configuration for RTSP NAT ALG

Following are the sample configuration for RTSP NAT ALG:

```

Config
active-charging service acs
  ruledéf rtsp-pkts
    tcp src-port = 554
    rule-application routing
#exit
ruledéf rtsp-pkts1
  tcp dst-port = 554
  rule-application routing
#exit
access-ruledéf SFW_HTTP
  ip any-match = TRUE
#exit
access-ruledéf prefix1
  ip server-ipv6-network-prefix = 64:ff98::/96
#exit
rulebase cisco
  tcp 2msl-timeout 20
  tcp mss 1300 limit-if-present
  route priority 105 ruledéf rtsp-pkts analyzer rtsp
  route priority 106 ruledéf rtsp-pkts1 analyzer rtsp
  rtp dynamic-flow-detection
  fw-and-nat default-policy nat_policy1
#exit
fw-and-nat policy nat_policy1
  access-rule priority 1 access-ruledéf prefix1 permit nat-realm NAT44_GRP1
  access-rule priority 10 access-ruledéf SFW_HTTP permit nat-realm NAT44_GRP1
  nat policy ipv4-and-ipv6
#exit
firewall nat-alg rtsp ipv4-and-ipv6

```

Sample Configuration for PPTP NAT ALG

Following are the sample configuration for PPTP NAT ALG:

```

configure
active-charging service ACS
  ruledéf pptp-route
    tcp either-port = 1723
    rule-application routing
    multi-line-or all-lines
  exit
rulebase cisco
  route priority 1 ruledéf pptp-route analyzer pptp
#exit
access-ruledéf all

```

```

        ip any-match = TRUE
#exit
access-ruledef ipv6_nat
ip server-ipv6-network-prefix = 101:101::/96
#exit
    rulebase cisco
    route priority 1 ruledef ptp-route analyzer ptp
    fw-and-nat default-policy nat_policy1
#exit
    fw-and-nat policy nat_policy1
    access-rule priority 1 access-ruledef ipv6_nat permit nat-realm NAT44_GRP1
    access-rule priority 100 access-ruledef all permit nat-realm NAT44_GRP1
    nat policy ipv4-and-ipv6
#exit
firewall nat-alg ptp ipv4-and-ipv6
#exit

```

Sample Configuration for TFTP NAT ALG

Following are the sample configuration for NAT44 on Control Plane:

```

configure
active-charging service ACS
    ruledef rt_tftp
        udp either-port = 69
        rule-application routing
        multi-line-or all-lines
    exit
    rulebase cisco
    route priority 1 ruledef rt_tftp analyzer tftp
#exit
#exit

```

Following are the sample configuration for NAT64 on Control Plane:

```

conf
    active-charging service ACS
    ruledef rt_tftp
        udp either-port = 69
        rule-application routing
        multi-line-or all-lines
    exit
    access-ruledef all
    ip any-match = TRUE
    exit
    access-ruledef ipv6_nat
    ip server-ipv6-network-prefix = 64:ff98::/96
    exit
    rulebase cisco
    route priority 1 ruledef rt_tftp analyzer tftp
    fw-and-nat default-policy nat_policy
#exit
end
conf
context ISP1
ip pool NAT44_PVT1 209.165.200.225 255.255.255.224 private 0 group-name NAT44_GRP1
ip pool NAT44_PVT4 209.165.200.226 255.255.255.224 private 0 group-name NAT44_GRP1
end
conf
context ISP1
apn cisco.com
ip address pool name NAT44_GRP1
fw-and-nat policy nat_policy1

```

```

    exit
  end
  configure
  active-charging service ACS
  fw-and-nat policy nat_policy1
  access-rule priority 1 access-ruledef ipv6_nat permit nat-realm NAT44_GRP1
  access-rule priority 10 access-ruledef all permit nat-realm NAT44_GRP1
  nat policy ipv4-and-ipv6
  end

```

Sample Configuration for H323 NAT ALG

Following are the sample configuration for H323 NAT ALG:

```

configure
active-charging service ACS
  ruledef h323
    udp dst-port = 1719
    rule-application routing
  #exit
  ruledef h323_multi
    udp dst-port = 1718
    rule-application routing
  #exit
  ruledef h323_tcp
    tcp dst-port = 1720
    rule-application routing
  #exit
rulebase cisco
route priority 6 ruledef h323 analyzer h323
  route priority 7 ruledef h323_tcp analyzer h323
  route priority 8 ruledef h323_multi analyzer h323
  rtp dynamic-flow-detection
fw-and-nat default-policy nat_policy1
#exit
  fw-and-nat policy nat_policy1
  access-rule priority 100 access-ruledef all permit nat-realm NAT44_GRP1
  nat policy ipv4-and-ipv6
#exit
firewall nat-alg h323 ipv4-only
#exit

```

Sample Configuration for SIP NAT ALG

Following are the sample configuration for SIP NAT ALG:

```

conf
active-charging service service_1
  ruledef sipalg
    udp dst-port = 5060
    rule-application routing
  #exit
  ruledef sipalg_tcp
    tcp dst-port = 5060
    rule-application routing
  #exit
access-ruledef server2
  ip dst-address = 209.165.200.224/27
#exit
access-ruledef nat64
  ip server-ipv6-network-prefix = cccc:1111::/96

```

```

    ip any-match = TRUE
#exit
#exit
rulebase base_1
    route priority 1 ruledef sipalg analyzer sip advanced description advanced
    route priority 2 ruledef sipalg_tcp analyzer sip advanced description advanced
    rtp dynamic-flow-detection
    fw-and-nat default-policy fw1
#exit
fw-and-nat policy fw1
    access-rule priority 2 access-ruledef server2 permit nat-realm natPool
    access-rule priority 3 access-ruledef nat64 permit nat-realm natPool
    nat policy ipv4-and-ipv6
#exit
firewall nat-alg sip ipv4-and-ipv6
#exit
#exi

```

Monitoring and Troubleshooting

This section provides information on CLI commands that are available for monitoring and troubleshooting for NAT ALG feature in CUPS.

Show Commands and/or Outputs

This section provides information about show CLI commands that are available in support of NAT ALG feature in CUPS.

- **show user-plane-service statistics analyzer name rtsp**: Use this command to view RTSP-related statistics.

```

RTSP Session Stats:
  Total Uplink Bytes:          844  Total Downlink Bytes:          1440
  Total Uplink Pkts:           10   Total Downlink Pkts:            6
  Uplink RTP Bytes:            8    Downlink RTP Bytes:           2851524
  Uplink RTP Pkts:             2    Downlink RTP Pkts:             2741
  Uplink Retry Bytes:          0    Downlink Retry Bytes:          0
  Uplink Retry Pkts:           0    Downlink Retry Pkts:           0
  RTSP Sessions:              1

```

- **show user-plane-service statistics analyzer name rtp**: Use this command to view RTP-related statistics.

```

RTP Session Stats:
  Total Uplink Bytes:          8    Total Downlink Bytes:          2851524
  Total Uplink Pkts:           2    Total Downlink Pkts:           2741

FastPath Statistics :
  Total FP Flows:              1
  Total Uplink FP Bytes:       0    Total Downlink FP Bytes:       2850497
  Total Uplink FP Pkts:       0    Total Downlink FP Pkts:       2740

```

- **show user-plane-service statistics analyzer name rtcp**: Use this command to view RTCP-related statistics.

```

RTCP Session Stats:
  Total Uplink Bytes:          804  Total Downlink Bytes:          728
  Total Uplink Pkts:           16   Total Downlink Pkts:           13

```

- **show user-plane-service statistics analyzer name ftp**: Use this command to view FTP-related statistics.

```

FTP Session Stats:
  Current Control Sessions:      1      Current Data Sessions:      1
  Total Control Sessions:        1      Total Data Sessions:        3
  Uplink Control Bytes:         190     Downlink Control Bytes:     544
  Uplink Control Pkts:          23      Downlink Control Pkts:     15
  Uplink Data Bytes:            6733    Downlink Data Bytes:       12444
  Uplink Data Pkts:            5136    Downlink Data Pkts:        14
  Uplink Error Bytes:           0       Downlink Error Bytes:       0
  Uplink Error Pkts:           0       Downlink Error Pkts:       0
  Request Succeed:              14     Request Failed:             0
  Unknown Requests:             0       Unknown Responses:         0
  Uplink Bytes Retrans:         0       Downlink Bytes Retrans:    0
  Uplink Pkts Retrans:         0       Downlink Pkts Retrans:     0
  RETR commands:                2       STOR commands:             1
  Unknown packets received:     0
  Data packet received without control connection: 0
  Invalid packets:              0
  Packets that could not be parsed: 0

FastPath Statistics :
  Total FP Control Flows:        0
  Total FP Data Flows:          3
  Uplink :
  Total FP Control Pkts :        0
  Total FP Control Bytes :       0
  Total FP Data Pkts :           0
  Total FP Data Bytes :          0
  Downlink :
  Total FP Control Pkts :        0
  Total FP Control Bytes :       0
  Total FP Data Pkts :           0
  Total FP Data Bytes :          0
    
```

- **show user-plane-service statistics analyzer name pptp:** Use this command to view PPTP-related statistics.

```

PPTP Session Stats:
  Total Uplink Bytes:           0      Total Downlink Bytes:       0
  Total Uplink Pkts:           0      Total Downlink Pkts:        0
  Total GRE Sessions:          0      Invalid PPTP Pkts:         0
  Unknown PPTP Pkts:           0

PPTP-GRE Session Stats:
  Total Uplink Bytes:           0      Total Downlink Bytes:       0
  Total Uplink Pkts:           0      Total Downlink Pkts:        0
    
```

- **show user-plane-service statistics analyzer name h323:** Use this command to view H323-related statistics.

```

H323 Session Stats:
  Total Uplink Bytes           0      Total Downlink Bytes       0
  Total Uplink Packets         0      Total Downlink Packets     0
  Total H323 calls             0
  Total RAS messages           0
  Total Q931 messages          0
  Total H245 messages          0
    
```

- **show user-plane-service statistics analyzer name h323 protocol ras:** Use this command to view the h323 protocol ras statistics.

```

Total RAS messages           0
  RAS messages
  Downlink
  -----
  GatekeeperRequest          0
  0
  GatekeeperConfirm          0
  0
  GatekeeperReject           0
  Uplink
  -----
  GatekeeperRequest          0
  GatekeeperConfirm          0
  GatekeeperReject           0
    
```

```

0
RegistrationRequest 0
0
RegistrationConfirm 0
0
RegistrationReject 0
0
UnregistrationRequest 0
0
UnregistrationConfirm 0
0
UnregistrationReject 0
0
AdmissionRequest 0
0
AdmissionConfirm 0
0
AdmissionReject 0
0
LocationRequest 0
0
LocationConfirm 0
0
LocationReject 0
0
DisengageRequest 0
0
DisengageConfirm 0
0
DisengageReject 0
0
InfoRequest 0
0
InfoRequestResponse 0
0
RequestInProgress 0
0
Unclassified 0
0

```

- **show user-plane-service statistics analyzer name h323**: Use this command to view H323-related statistics.

```

H323 Session Stats:
Total Uplink Bytes 0 Total Downlink Bytes 0
Total Uplink Packets 0 Total Downlink Packets 0
Total H323 calls 0
Total RAS messages 0
Total Q931 messages 0
Total H245 messages 0

```

- **show user-plane-service statistics analyzer name h323 protocol h245** : Use this command to view the h323 protocol h245 statistics.

```

Total H245 messages 0
H245 messages Uplink Downlink
-----
-----
OpenLogicalChannel 0
0
OpenLogicalChannelAck 0
0
OpenLogicalChannelReject 0

```

```

0
OpenLogicalChannelConfirm          0
0
RequestChannelClose                0
0
CloseLogicalChannel                0
0
CloseLogicalChannelAck             0
0
EndSessionCommand                  0
0
Unclassified                        0
0
    
```

- **show user-plane-service statistics analyzer name h323 protocol q931** : Use this command to view the h323 protocol q931 statistics.

```

Total Q931 messages          0
Q931 messages                Uplink          Downlink
-----
Alerting                      0
0
CallProceeding                0
0
Setup                          0
0
Connect                       0
0
ReleaseComplete               0
0
Facility                      0
0
Progress                      0
0
Information                    0
0
Unclassified                  0
0
    
```

- **show user-plane-service statistics analyzer name tftp**: Use this command to view TFTP-related statistics.

```

TFTP Session Stats:
Total Uplink Bytes:          0   Total Downlink Bytes:          0
Total Uplink Packets:       0   Total Downlink Packets:       0
Total Read Sessions:        0   Total Write Sessions:         0
Total Invalid Control Packets: 0
Total Invalid Data Packets:  0
Total Packets with Unknown Request Type: 0

TFTP DATA Session Stats:
Total Uplink Bytes:          0   Total Downlink Bytes:          0
Total Uplink Packets:       0   Total Downlink Packets:       0
    
```

- **show user-plane-service statistics analyzer name sip**: Use this command to view SIP-related statistics.

```

SIP Session Stats:
Total Uplink Bytes:          0   Total Downlink Bytes:          0
Total Uplink Pkts:           0   Total Downlink Pkts:           0
Uplink Valid Pkts:           0   Downlink Valid Pkts:           0
Uplink Retry Pkts:           0   Downlink Retry Pkts:           0
Uplink Error Pkts:           0   Downlink Error Pkts:           0
    
```

```

Total SIP Calls:                                0
SIP Advanced Session Stats:
Total Uplink Bytes                             0   Total Downlink Bytes           0
Total Uplink Packets                           0   Total Downlink Packets         0

Total SIP Calls                               0   Current SIP Calls              0
Total SIP UDP Calls                           0   Current SIP UDP Calls          0
Total SIP TCP Calls                           0   Current SIP TCP Calls          0

SIP Request                                     Total received                 Total transmitted
Retransmitted
-----
Register                                         0                               0
    0
Invite                                           0                               0
    0
Ack                                               0                               0
    0
Bye                                               0                               0
    0
Info                                              0                               0
    0
Prack                                             0                               0
    0
Refer                                             0                               0
    0
Cancel                                           0                               0
    0
Update                                           0                               0
    0
Message                                          0                               0
    0
Options                                          0                               0
    0
Publish                                          0                               0
    0
Subscribe                                       0                               0
    0
Notify                                           0                               0
    0

SIP Response                                     Total received                 Total transmitted
Retransmitted
-----
1XX                                               0                               0
    0
2XX                                               0                               0
    0
3XX                                               0                               0
    0
4XX                                               0                               0
    0
5XX                                               0                               0
    0
6XX                                               0                               0
    0

```



CHAPTER 55

Netloc and RAN/NAS Cause Code

- [Revision History, on page 463](#)
- [Feature Description, on page 463](#)
- [Configuring Netloc and RAN/NAS Cause Code, on page 464](#)

Revision History



Note Revision history details are not provided for features introduced before release 21.24.

Revision Details	Release
First introduced	Pre 21.24

Feature Description

The Netloc and RAN/NAS Cause Code feature is supported in non-CUPS architecture. With this release, this feature is qualified in CUPS architecture.

This feature is used to send detailed RAN and/or NAS release cause code information from the access network to PCRF.

This feature is in compliance with Release 12 specification of 3GPP TS 29.212.

If the supported features "netloc-ran-nas-code" and "netloc" are enabled, then netloc-ran-nas-cause code are sent to the PCRF through CCR-U/CCR-T message.

In the Charging-Rule-Report AVP and CCR-T, the Diameter AVP "RAN-NAS-Release-Cause" is included for bearer and session deletion events respectively when the NetLoc-RAN-NAS-Cause supported feature is enabled and the RAN/NAS cause is received from the access side.

In the CCR-U and CCR-T, the network location is sent in the Diameter AVP "3GPP-User-Location-Info" and/or "3GPP-MS-TimeZone" is included for creation/updation/deletion of bearer or session events respectively when the NetLoc-RAN-NAS-Cause supported feature is enabled and the Netloc is received from the access side.

Configuring Netloc and RAN/NAS Cause Code

Use the following configuration to enable the feature.

```
configure
  context context_name
    ims-auth-service service_name
      policy-control
        diameter encode-supported-features netloc-ran-nas-cause
      end
    end
```

NOTES:

- **netloc-ran-nas-cause**: Enables the Netloc-RAN-NAS-Cause feature. By default, this supported feature will be disabled.
- If the supported features "netloc-ran-nas-code" and "netloc" are enabled, then netloc-ran-nas-cause code will be sent to PCRF.
- To disable this supported feature, use the following command:
[**default** | **no**] **diameter encode-supported-features**
- This feature is supported only for standard Gx dictionary (r8-gx-standard and dpca-custom8).



CHAPTER 56

Network Triggered Service Restoration

- [Feature Description, on page 465](#)
- [Configuring NTSR, on page 465](#)
- [Monitoring and Troubleshooting, on page 467](#)

Feature Description

The Network Triggered Service Restoration (NTSR) feature detects an MME failure when enabled on the S-GW. If the subscriber served by the failed MME receives any downlink data packets, then the S-GW selects an alternate MME from the NTSR pool in round-robin fashion. The S-GW then sends a Downlink Data Notification (DDN) to the selected MME. This round robin selection of an MME is per session manager instance and not system wide.

The NTSR feature improves load balancing of DDN messages in the network during an MME failure.

In CUPS mode, bearers which are applicable for restoration, the corresponding downlink data is buffered on User Plane. For bearers that are not configured for restoration, the corresponding traffic endpoints are removed from the User Plane.

If S-GW detects that dedicated bearers are retained from a particular PDN, the S-GW retains the default bearer as well for this PDN. In this case, Downlink data will be dropped on default bearer.

On receiving any downlink data/Update Bearer Request/Create Bearer Request in restoration pending state, the SGW initiates a DDN request event towards MME or S4-SGSN.

Upon receiving Modify Bearer Request from MME, Control Plane sends Sx Session Modification Request to User Plane with UPDATE FAR:APPLY ACTION:FORW=1 for all bearers which are applicable for restoration.

Configuring NTSR

The NTSR feature involves the following configurations:

- APN Profile Configuration
- Peer Profile Configuration (Ingress)
- NTSR Pool Configuration
- S-GW Service Access Peer Map Association

- MME Restoration Timer Configuration

APN Profile Configuration

In this configuration, the QCI and ARP values are configured in the APN profile. When path failure is detected on the ingress side of the S-GW, bearers are retained or released based on the configured ARP/QCI values. S-GW can configure a maximum of two QCI and ARP-watermark combination per APN-profile.

Use the following commands to configure the ARP and QCI values in the APN profile.

```
configure
  apn-profile profile_name
    ntsr { all | qci qci_value | arp-priority-watermark arp_value }
  end
```

NOTES:

- **ntsr**: Specifies the NTSR configuration.
- **qci**: Specifies the QCI value for NTSR.
- **arp-priority-watermark**: Specifies the ARP value for NTSR.
- **all**: Identifies for all bearers with QCI or ARP values for MME restoration.

Peer Profile Configuration (Ingress)

In this configuration, the Peer Profile is configured on the ingress side of S-GW. The peer profile contains an associated pool-id, which is used to detect MME/S4-SGSN pool after MME failure.

Use the following commands to configure peer-profile on the ingress side at S-GW.

```
configure
  peer-profile service-type sgw-access name name
    ntsr pool-id pool_id
  end
```

NOTES:

- **sgw-access**: Configures the profile for peer nodes of S-GW towards S4/S11 interfaces.
- **ntsr**: Specifies the NTSR configuration.
- **pool-id**: Specifies the pool ID to detect MME/S4-SGSN pool after MME failure. The *pool_id* is an integer in the range of 1 to 10.

NTSR Pool Configuration

The NTSR pool configuration is used to configure pool of IP addresses associated with a pool-id and a peer type. One pool ID can be used for one peer-type. The NTSR pool can have combination of IPv4 or IPv6 address. S-GW can be configured with a maximum of 10 NTSR pools, and with at maximum of 5 IPv4v6 IP address pairs.

Use the following configuration to configure the NTSR Pool.

```

configure
  ntsr-pool pool-id pool_id peer-type [ mme | s4-sgsn ]
    [ no ] peer-ip-address { ipv4-address ipv4_address | ipv6-address
ipv6_address }
  end

```

NOTES:

- **pool-id**: Specifies the NTSR pool ID.
- **peer-type**: Specifies the NTSR Pool ID peer type. The peer type is either MME or S4-SGSN.
- **peer-ip-address**: Configures the IPv4 address or IPv6 address as a part of the MME or S4-SGSN pool.

S-GW Service Access Peer Map Association

In this configuration, the peer map on the Access side or Ingress side of S-GW service is configured.

Use the following configuration to associate a peer map to an S-GW service.

```

configure
  context context_name
    sgw-service service_name
      associate access-peer-map peermap_name
    end

```

NOTES:

- **access-peer-map**: Configures the Access/Ingress side peer map for an S-GW service.

Monitoring and Troubleshooting

Show Commands Input and/or Outputs

This section provides information regarding show commands and their outputs in support of the feature.

show apn-profile full all

The output of this command displays the following fields in support of this feature:

- NTSR
 - QCI
 - ARP-priority-watermark

show apn-profile full name *apn_name*

The output of this command displays the following fields in support of this feature:

- NTSR
 - QCI

- ARP-priority-watermark

show ntsr-pool all

The output of this command displays the following fields in support of this feature:

- SGW NTSR pools
- NTSR pool-id
- NTSR Pool type
- NTSR pool-id
- NTSR Pool type

show ntsr-pool full all

The output of this command displays the following fields in support of this feature:

- NTSR pool-id
- NTSR Pool type
- peer-address-pair(s)

show ntsr-pool full pool-id *pool_id*

The output of this command displays the following fields in support of this feature:

- NTSR pool-id
- NTSR Pool type
- peer-address-pair(s)

show ntsr-pool pool-id *pool_id*

The output of this command displays the following fields in support of this feature:

- NTSR pool-id
- NTSR Pool type

show sgw-service statistics all

The output of this command displays the following fields in support of this feature:

- Peer Failure
 - Retained
 - Restored
 - Released

- Peer Restart
 - Retained
 - Restored
 - Released

show subscribers sgw-only full all

The output of this command displays the following fields in support of this feature:

- NTSR state
- Bearer capable restoration

show subscribers sgw-only full all



CHAPTER 57

Network Provided Location Indication

- [Revision History](#), on page 471
- [Feature Description](#), on page 471
- [How It Works](#), on page 471

Revision History



Note Revision history details are not provided for features introduced before release 21.24.

Revision Details	Release
First introduced	Pre 21.24

Feature Description

This feature enables the P-GW to provide the required access network information to the PCRF within the TWAN-Identifier AVP, User-Location-Info-Time AVP (if available), and/or UE-Local-IP-Address AVP as applicable for S2a/S2b. The P-GW also provides the ACCESS_NETWORK_INFO_REPORT event trigger within Event-Trigger AVP.



Important The Network Provided Location Indication (NPLI) is an existing feature that is supported in non-CUPS architecture. With this release, the feature is qualified in CUPS architecture. For more information, refer the *NetLoc for WiFi EPC* chapter in the *SAEGW Administration Guide*.

How It Works

During bearer deactivation or UE detach procedure, the P-GW provides the access network information to the PCRF within the TWAN-Identifier AVP and information on when the UE was last known to be in that location within User-Location-Info-Time AVP, and/or UE-Local-IP-Address AVP as applicable for S2a/S2b.

If the PCRF request for user-location information as part of the Required-Access-Info AVP and it is not available in the P-GW, then the P-GW provides the serving PLMN identifier within the 3GPP-SGSN-MCC-MNC AVP.

Previously, the P-GW notified ULI/MS-TimeZone/PLMN-ID to ECS/IMSA/PCRF only when their value changed. With this feature, the P-GW receives NetLoc indication in the rules sent by ECS regardless of whether the values changed, and it sends this to the ECS/IMSA/PCRF. If the P-GW receives NetLoc as "1", then it informs the MS-Timezone. If the P-GW receives NetLoc as '0', then it informs the ULI and ULI Timestamp. If ULI is not available in that case, then the PLMN-ID is sent. If NetLoc indication is received for an update, then the P-GW indicates this information to the access side in the UBRReq using the RetLoc Indication flag.

This is required for VoLTE and aids in charging and LI functionality in IMS domain. This feature allows EPC to support an efficient way of reporting ULI and Time-Zone information of the subscriber to the IMS core network.

NOTE: In CUPS, when dedicated bearer is created by PCRF, it waits for CBRsp to trigger the CCR-I (for new bearer, NSAPI) towards OCS server. Since there is no usage for this bearer until this point, instead of sending a CCR-I with old access side information and following it up with a new CCR-U with updated access side information, the P-GW sends a single CCR-I message with updated access side information.

Supported Functionality

Netloc sent in CBRes/DSReq/UBRes/DBC/DBRes is supported on Gx, Gy, and Gz interfaces. The NPLI feature is supported for:

- Pure-P, Collapsed, and Pure-S sessions
- WiFi sessions
- S-GW Relocation
- Session Recovery

Limitations

The NPLI feature has the following limitations:

- GnGp handover scenarios are not supported.
- When there is a change in Netloc in UBRes, CDR for TimeZone change is not generated.
- When there is a ULI change in Netloc in DSReq, serviceConditionChange is blank in the CDR.

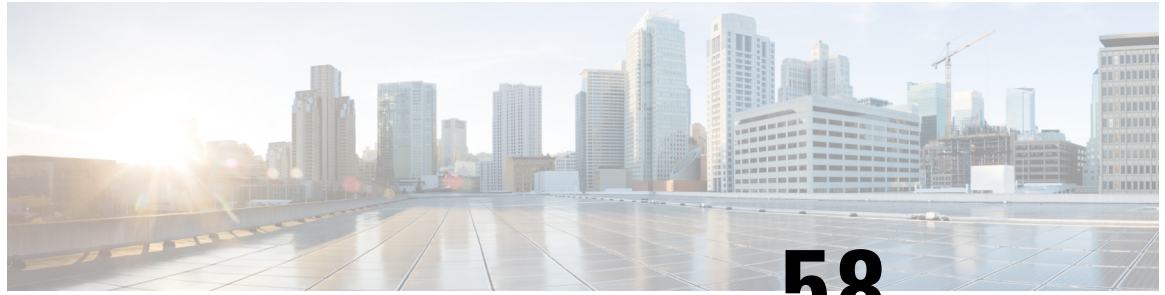

CHAPTER 58

NextHop Forwarding Support IPv4/v6 Address

- [Revision History, on page 473](#)
- [Feature Description, on page 473](#)
- [How It Works, on page 473](#)
- [Configuring NextHop Forwarding Support IPv4/IPv6 Address, on page 477](#)
- [Monitoring and Troubleshooting, on page 478](#)

Revision History



Note Revision history details are not provided for features introduced before release 21.24.

Revision Details	Release
First introduced	Pre 21.24

Feature Description

In uplink direction at CUPS UPF, UE IP and the GI IP might be in a different subnet and the routing path is defined to allow the uplink packet forward accordingly.

How It Works

Architecture

The following illustration provides EGCI-based P-GW UP Selection Solution overview.

Figure 33: NextHop Forwarding

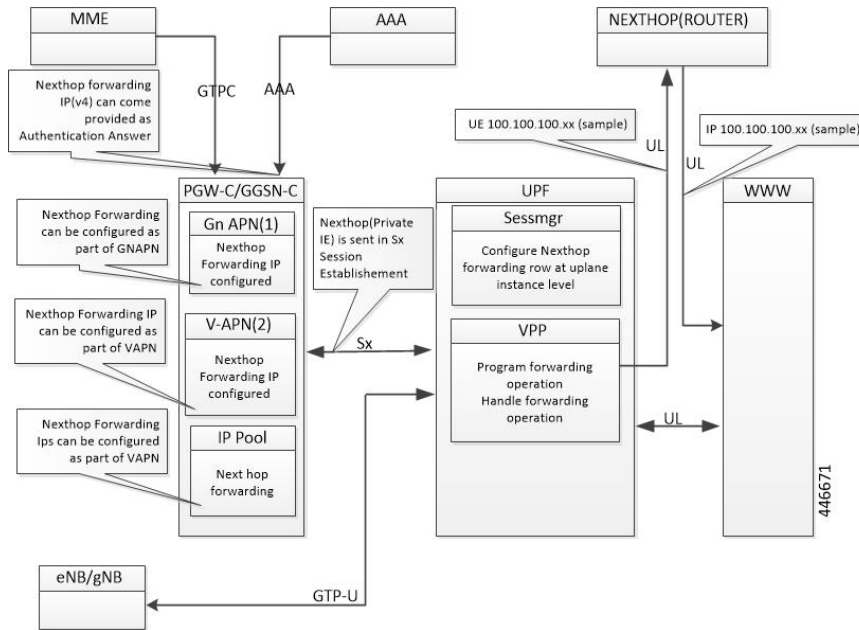

Configuration Priority

Configuration	Priority
AAA (Only IPv4)	1
APN (Gn/VAPN)	2
IP Pool	3

Configuration Use Cases

Case	IP Type	AAA	APN	IP Pool	NextHop IP Selection
NextHop supplied Only in AA message over AAA	IPv4	209.165.200.225	Not configured	Not configured	NextHop Address Selected from AAA: IPv4: 209.165.200.225 IPv6: NA
	IPv6	Not supported	Not configured	Not configured	
NextHop that is supplied in AA message over AAA + IPv4 configured in APN and IP Pool	IPv4	209.165.200.225	209.165.201.1	50.50.50.50	NextHop Address is selected from AAA: IPv4: 209.165.200.225 IPv6: NA
	IPv46	Not supported	Not configured	Not configured	

Case	IP Type	AAA	APN	IP Pool	NextHop IP Selection
IPv4 and IPv6 configured in APN only	IPv4	Not configured	209.165.201.1	Not configured	NextHop Address is selected from APN: IPv4: 209.165.200.225 IPv6: 9001::3
	IPv6	Not supported	9001::3	Not configured	
IPv4 and IPv6 configured in IP Pool only	IPv4	Not configured	Not configured	50.50.50.50.	NextHop Address is selected from IP Pool: IPv4: 209.165.200.225 IPv6 : 5002::5
	IPv6	Not configured	Not configured	5002::5	
IPv4 available over AAA + IPv4 and IPv6 configure on APN and IP Pool	IPv4	209.165.200.225	209.165.201.1	50.50.50.50	NextHop IPv4 is selected from AAA: 209.165.200.225 NextHop IPv6 selected from APN : 9001::3
	IPv6	Not Supported	9001::3	5002::5	
IPv4 available over AAA + IPv4 and IPv6 configure on IP Pool	IPv4	209.165.200.225	Not configured	50.50.50.50	NextHop IPv4 is selected from AAA: 209.165.200.225 NextHop IPv6 selected from IP Pool: 5002::5
	IPv6	Not Supported	Not configured	5002::5	
IPv4 available over AAA + IPv4 and IPv6 configure on APN.	IPv4	209.165.200.225	209.165.201.1	Not configured	NextHop IPv4 is selected from AAA: 209.165.200.225 NextHop IPv6 selected from APN: 9001::3
	IPv6	Not Supported	9001::3	Not configured	

Interface

Following Private IEs are introduced in SX Session Establishment message.

2 3 8	PFCP _IE_ NEXT HOP	PFCP_IE_NEXTHOP							Sx Session Establish ment Request	Private IE : CUPS: nexthop forward ing support- IPv4 /IPv6 address	
		BITS									
		Octets	7	6	5	4	3	2			1
		1 to 2	Type = 238 (decimal)								
		3 to 4	Length = n								
		5 to 10	PFCP_IE_NEXTHOP_ID								
		11-14	PFCP_IE_NEXTHOP_IP								

2 3 9	PFCP _IE_ NEXTHOP _ID	PFCP_IE_NEXTHOP_ID							1. Inside create far IE of Sx Session Establishment Request	Private IE : CUPS: nexthop forwarding support- IPv4 /IPv6 address	
		BITS									2. Inside PFCP _IE_ NEXTHOP IE of Sx Session Establishment Request
		Octets	7	6	5	4	3	2	1		
		1 to 2	Type = 239 (decimal)						PFCP _IE_ NEXTHOP of Sx Session Establishment Request		
		3 to 4	Length = 5								
		5 to 10									

2 4 0	PFCP_IE_NEXTHOP_IP	PFCP_IE_NEXTHOP_IP												
		Bits										PFCP_IE_NEXTHOP of Sx Session Establishment Request	Private IE : CUPS: nexthop forwarding support-IPv4/IPv6 address	
		Octets	7	6	5	4	3	2	1					
		1 to 2	Type = 240 (decimal)											
		3 to 4	Length = n											
		5	spare					V4	V6					
		m to m+3	IPv4 Address											
		p to p+15	IPv6 Address											

Configuring Nexthop Forwarding Support IPv4/IPv6 Address

Configuring Nexthop Forwarding at APN Configuration Mode

Use the following CLI commands to configure Nexthop Forwarding at APN.

```

configure
  context context_name
    apn apn_name
      nexthop-forwarding-address { ipv4v6_address | ipv4_address | ipv6_address
    }
    no nexthop-forwarding-address
  end
    
```

NOTES:

- **no:** Disables Nexthop forwarding address configuration.
- **nexthop-forwarding-address** { *ipv4v6_address* | *ipv4_address* | *ipv6_address* }: Configures the Nexthop forwarding address for this APN.
 - *ipv4_address* Configures IPv4 address.
 - *ipv6_address* Configures IPv6 address (supports colon-separated hexadecimal notation).

Configuring Nexthop Forwarding at IP Pool

Use the following CLI commands to configure Nexthop Forwarding at APN.

```

configure
  context context_name
    
```

```

[ no ] ip pool ipv4-public nexthop-forwarding-address  ipv4_address
[ no ] ip pool ipv6-public nexthop-forwarding-address  ipv6_address
end

```

NOTES:

- **no**: Disables Nexthop forwarding address configuration.
- **nexthop-forwarding-address** *ipv4_address* / *ipv6_address*: Configures the IPv4 address Nexthop forwarding address for this pool.
- **nexthop-forwarding-address** *ipv6_address*: Configures the IPv6 address Nexthop forwarding address for this pool.

Configuring Nexthop Forwarding Through AAA

Nexthop Forwarding Address can be configured through AAA. This option allows us to configure externally.

Configuring Nexthop Forwarding externally:

```

RADIUS AUTHENTICATION
Access-Accept
Subscriber-Nexthop-Address

```

Monitoring and Troubleshooting

This section provides information about CLI commands available for monitoring and troubleshooting the feature.

Show Commands and Outputs

This section provides information about show commands and their outputs in support of this feature.

show apn name <apn_name>

The output of this show command is enhanced to include the following fields introduced in support of this feature.

- **nexthop gateway addr**: Displays the configured Nexthop gateway address.

show subscriber user-plane-only full all

The output of this show command is enhanced to include the following fields introduced in support of this feature.

- **Next Hop Ip Address** - Displays the configured Nexthop IP address.



CHAPTER 59

NSO-based Configuration Management

- [Feature Description, on page 479](#)
- [How it Works, on page 480](#)
- [CUPS Configuration MOP, on page 490](#)
- [Troubleshooting, on page 522](#)
- [Appendix A: Incompatible StarOS Native Command Syntax, on page 523](#)
- [Appendix B: Example Configurations for N:M Deployment with RCM, on page 526](#)

Feature Description

The Cisco Network Service Orchestrator (NSO) based configuration management for 4G CUPS supports:

- Onboarding of Cisco Virtual Network Function (VNF) devices—CP, UP, and RCM
- Centralized configuration management of 4G-based CPs, UPs, and RCMs for Day-N, Day-1, and Day-0.5 CUPS configuration push.
 - Day-0.5 applies to N:M UP redundancy scheme that uses RCM. The Day-0.5 configuration is intended for the UP to communicate to the RCM, so that its role can be defined and suitable configuration be pushed subsequently.

Managing customer configuration management for 4G CUPS deployments using NSO automation also exhibits reusability, standard notification management, and systematic device configuration governance.

Use Cases

The NSO configuration-handling caters to the following use cases:

1. NSO on-boarding of VNFs (CPs, UPs, and RCMs) that are already deployed using Management IPs:

- Onboarding of already-running VNFs (CPs, UPs, and RCMs) as devices into NSO and perform post-check to ensure the reachability and functioning of the devices. This is preliminary step to push/sync any configuration and establish communication for notifications.

Orchestration of VNF devices (Instantiation and Destroy) is a separate module, and it doesn't have any dependency on configuration module. We need certain details (IP, Port, Management Username/Password) to onboard the device and supporting configuration management.

2. Allowing to store native-configs or device-templates for CPs, UPs, and RCMs:
 - Providing interface through RESTCONF/NSO-CLI to manage the reusable configurations for devices with logical name. Providing flexibility to network SMEs/Operators to create, modify, delete, and disable/enable the configurations. Aim is to pick those active configurations and apply to the device set as part of Day-0.5, Day-1, or Day-N for CPs, UPs, and RCMs.
3. Providing CLI/REST interface to apply Day-N/Day-1/Day-0.5 configurations to device logical groups (including CPs/UPs/RCMs) or custom list of target devices:
 - Providing interface through RESTCONF/NSO-CLI to Network SMEs/Operators to push Day-N/Day-1/Day-0.5 configurations to single or set of devices (CPs, UPs, or RCMs). This interface exhibits notifications/status on the progress of configuration push to the end users.
4. Logistic management of configuration management per device basis (Day-N, Day-1, or Day-0.5 pushed):
 - Providing dashboard utility and managing the configuration logs per device basis. This log is useful to know the most recent activity done on the device.
5. 5. Build the notification framework for RCM notification management in (N:M cases) and automate the configuration push for UPs for Day-N, Day-1, and Day-0.5:
 - Building notification framework in NSO to listen to RCM NetConf notifications on status changes, and push configurations automatically based on scenarios.

How it Works

.

Architecture

The following diagram illustrates, at a high-level, the components and frameworks involved in the solution.

NSO Based Automation Architecture

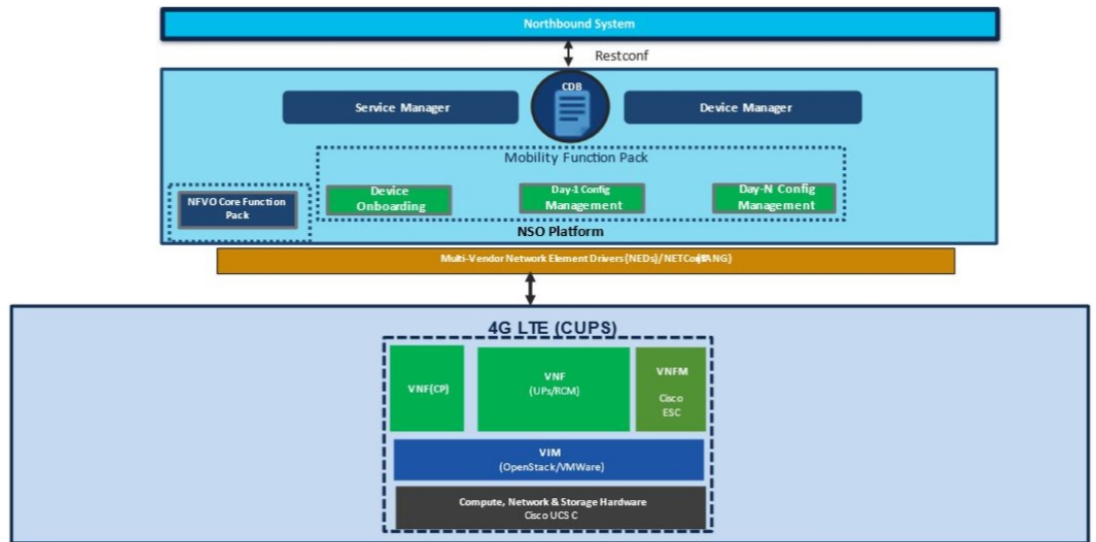

RCM and NSO

In the N:M UP redundancy scenario, while the NSO manages configuration, the RCM will continue to arbitrate the role of the UPs (Active or Standby) and handle the switchover of an Active UP. Hence, this solution only moves the configuration function out of the RCM into the NSO; RCM is still required. For details about RCM, refer to the *RCM Configuration and Administration Guide*.

Components

Cisco 4G CUPS VNF deployment and configuration workflows are driven from the NSO. The following are some of the important components of NSO:

- **NSO Device Manager:** Manages each VNF component (CP, UP, RCM), keeps the copy of each device configurations, and manages the integrity of device configuration push.
- **NSO Service Manager:** Provides YANG standard to define high-level abstraction network service model for the customer/user input.
- **CDB:** Persistent Configuration Database for storing network configurations and operational data.
- **Mobility Function Packs:** Custom-built NSO packages to manage the 4G CUPS-based VNF orchestration and configuration management.
- **NFVO Core Function Pack:** NSO core NFV FP is a driver software to communicate with Cisco or other 3rd party VNFM's and VIMs, like OpenStack/VMWare, to deploy VNFs.
- **StarOS NSO NED:** StarOS-based NSO Network Element Driver (NED) that interfaces with the Cisco 4G CUPS VNFs for configuration push. This NED is based on Cisco CLI. The StarOS NSO NED communicates with the StarOS management CLI instance using Secure Shell (SSH).
- **RCM NSO NED:** RCM-based NETCONF NED is used to communicate with RCM devices for configuration management.

Minimum Platform, Hardware, and Software Requirements

The following are the minimum platform and software requirements to support centralized configuration management:

- Supported Orchestrator: NSO
- Configuration management for following Network Element's:
 - RCM: Redundancy and Configuration Management
 - VPC-SI: As 4G CUPS CP or UP
 - VPC-DI: As 4G CUPS CP only
- Minimum hardware requirements:
 - VM CPU: 8 CPU cores
 - VM RAM: 16 GB RAM baseline + 10 MB RAM for every StarOS device to be supported
 - VM connectivity: One 10 GBps network link. This can be used for both NSO HA and config/deployment by using separate VLANs or other mechanisms
 - VM Storage: 100 GB disk (preferably, SSD)
- Minimum software version

Software	Minimum Version
Cisco NSO	6.1.6.1
StarOS NSO NED	5.52.4
Cisco NSO HCC	6.0.1
Mobility Function Pack	3.5



Note The recommended StarOS software image version for UP, CP, and RCM is 21.23 and later releases. The release versions are not tightly coupled and only depend on the NEDs.

Licensing

The NSO-based Configuration Management is a licensed Cisco feature. Contact your Cisco Account representative for detailed information on specific licensing requirements.

NSO Installation

Call Flows

This section describes the key call flows for the 4G CUPS configuration management functionality.

The call flows refer to NSO primitives like "connect", "sync-from", and so on. For detailed information on these primitives, refer to the *NSO User Guide*.



Note In the following call flow diagrams, “NSO Northbound” implies NCS CLI or RESTCONF interface.

Onboarding Existing 4G CUPS VNFs into NSO

This section describes the flow for adding existing 4G CUPS devices to NSO.

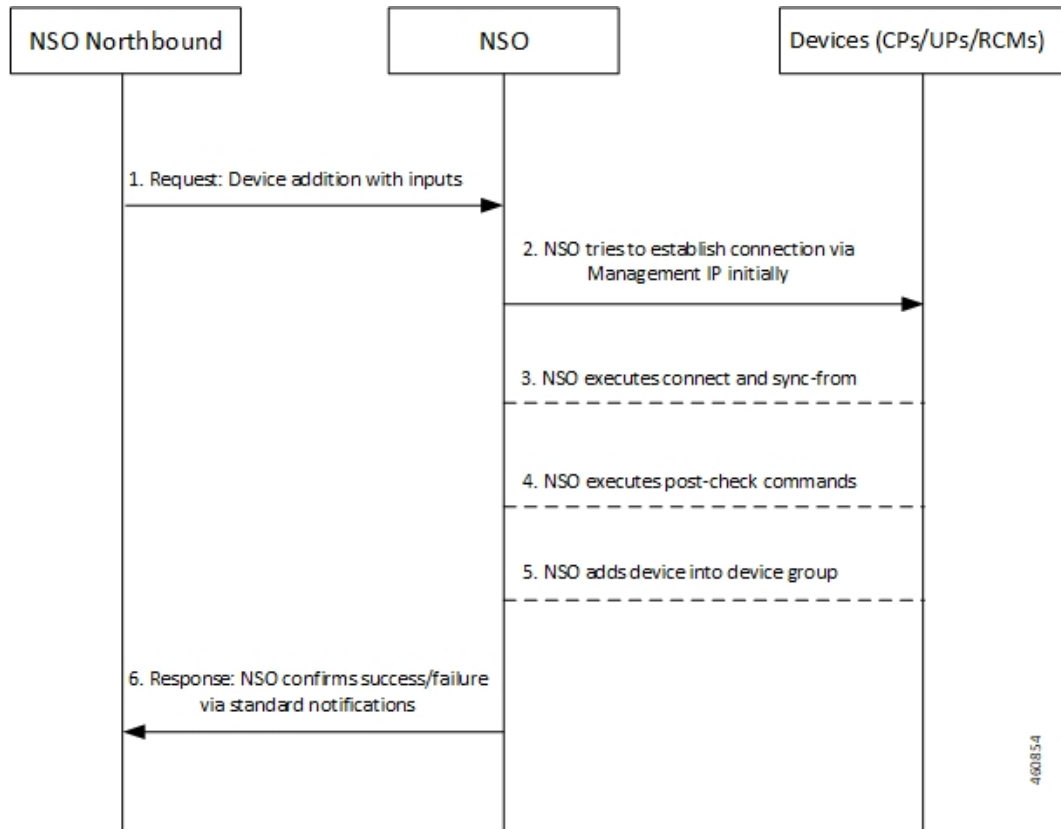

Table 36: Call Flow Description

Step	Description
1	NSO Northbound sends a request to NSO for adding devices into device-group. A device-group is a logical grouping of devices (VNFs) that share nearly identical configurations. This simplifies configuration in certain cases.

Step	Description
2	NSO initially attempts to establish a connection via Management IP.
3	NSO executes connect and sync-from commands. A sync-from operation pulls the existing configuration from the device/VNF into the NSO so that NSO is aware of the exact configuration on the device. The device configuration is not changed in a sync-from.
4	NSO executes post-check commands.
5	NSO adds device into device group.
6	NSO updates NSO Northbound about the success or failure of device addition via standard notifications.

4G CUPS Device Configuration Push – Manual

This section describes the flow for manual configuration push for 4G CUPS device.

This scenario applies to CPs, UPs, or RCMs in standalone or 1:1 redundancy configuration.

Prior to any configuration push, the device(s) must be onboarded. See [Onboarding Existing 4G CUPS VNFs into NSO, on page 483](#).

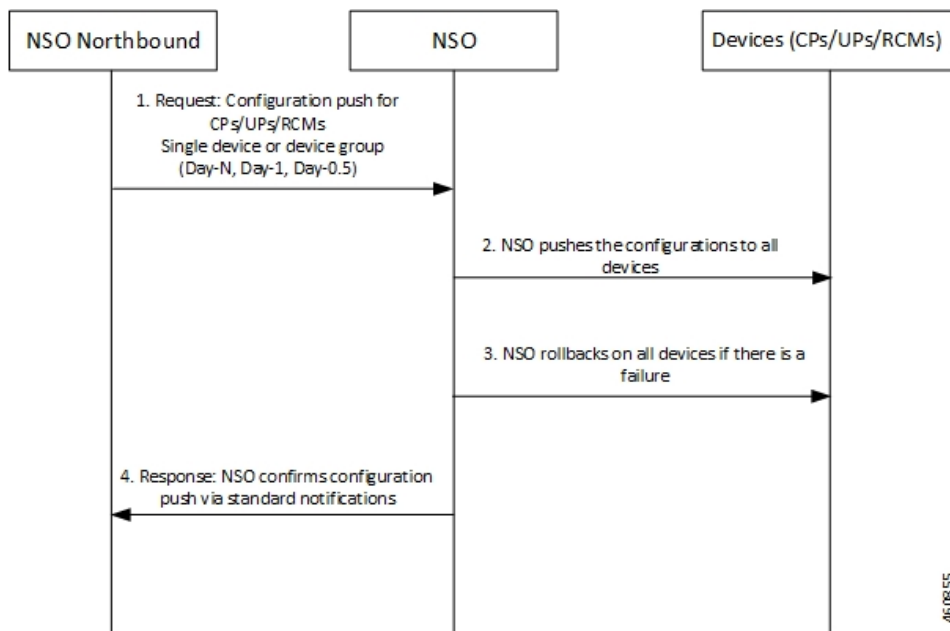

Table 37: Call Flow Description

Step	Description
1	NSO Northbound requests the NSO for a configuration push on devices such as CPs or Ups or RCMs. The devices can be a single device or a device group (Day-N, Day-1, Day-0.5).

Step	Description
2	NSO pushes the configurations to all devices.
3	If there is a failure, NSO rolls back the configuration on all devices. A rollback operation undoes the configuration applied to the device so as to restore it to the previous state (prior to application of the configuration).
4	NSO updates NSO Northbound about the configuration push via standard notifications.

Configuration Push from NSO to 4G CUPS UPs in N:M Redundancy – Automated

This section describes the flow for automatic configuration push from NSO to 4G CUPS devices.

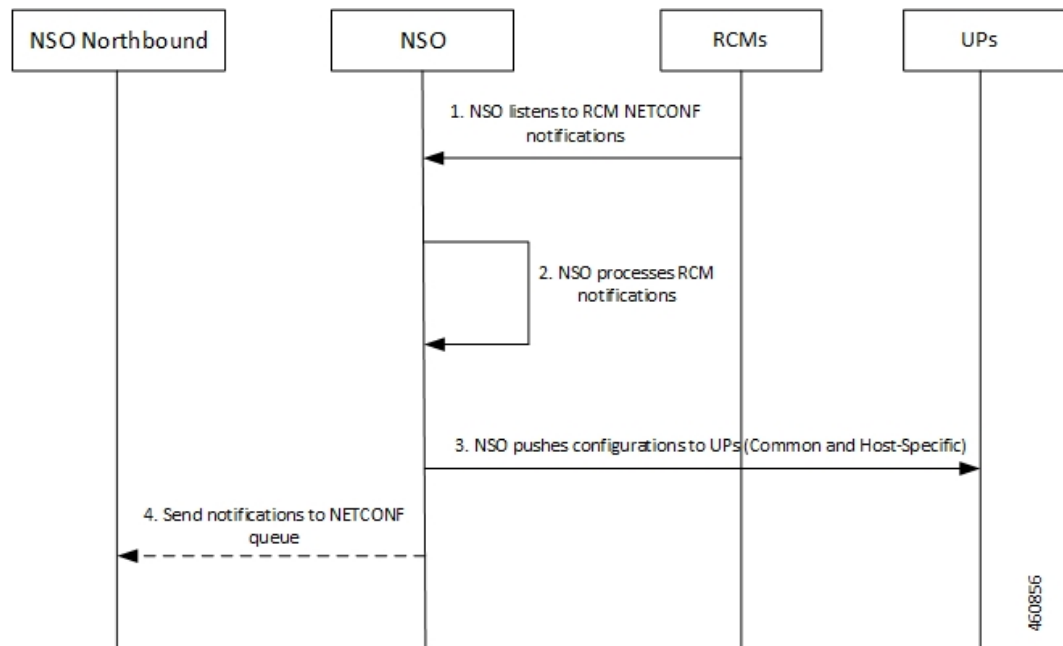

Table 38: Call Flow Description

Step	Description
1	NSO listens to RCM NETCONF notifications. When a UP connects to the RCM, the RCM decides what the UPs role should be (Active or Standby). This role is communicated in the notification. The configuration pushed to the UP is dependent on its role. So, the automated configuration push is driven based on the RCM notification.
2	NSO processes the received RCM notifications.

Step	Description
3	NSO pushes the common and host-specific configurations to UPs. Common configuration refers to the configuration that is shared across all the UPs in a redundancy group. This is typically Enhanced Charging Service (ECS) and Access Point Name (APN) configurations. Host-specific configuration is unique to an Active UP. Each Active UP needs its host-specific configuration. All Standby UPs need the host-specific configurations of all Active UPs, since Standby UP needs to be able to take over for any Active UP.
4	NSO sends notifications to NETCONF queue.

Configuration Metadata Pre-population

This section describes the flow for pre-population of configuration metadata

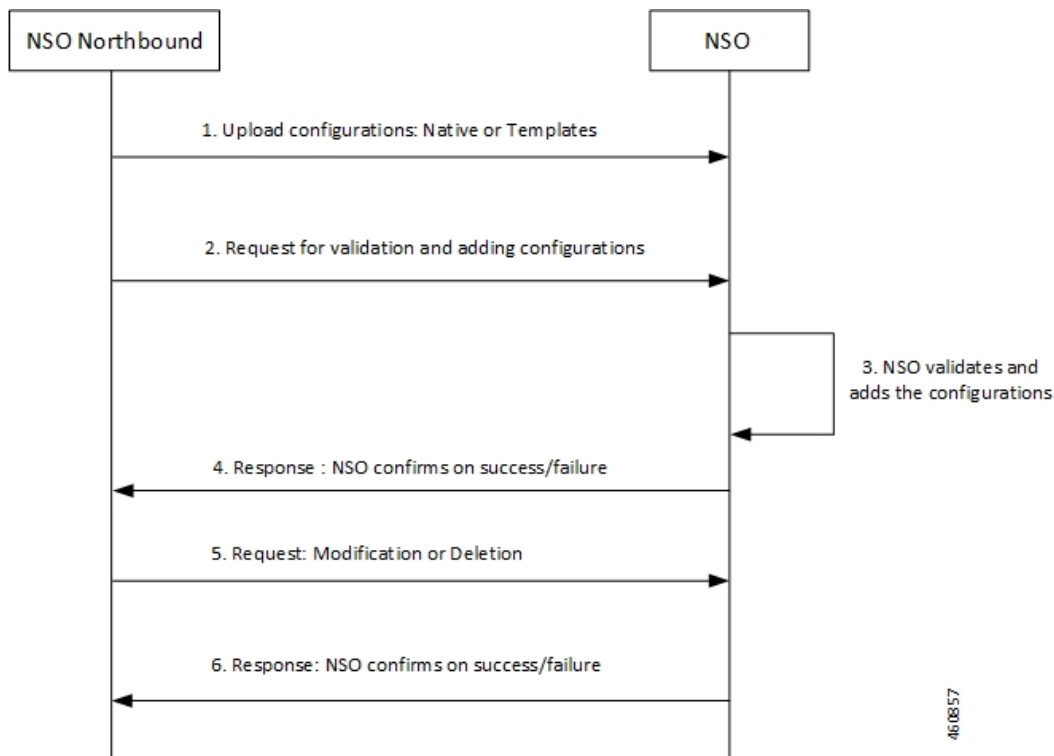

Table 39: Call Flow Description

Steps	Description
1	NSO Northbound uploads the configurations (native or templates) to NSO.
2	NSO Northbound requests NSO to validate and add configurations.
3	NSO validates and adds the configurations.
4	NSO updates NSO Northbound about the success or failure of device addition.

Steps	Description
5	NSO Northbound requests NSO for modification or deletion of configurations.
6	NSO updates NSO Northbound about the success or failure.

NSO HA Switchover Handling

This section describes the flow of handling NSO HA switchover.

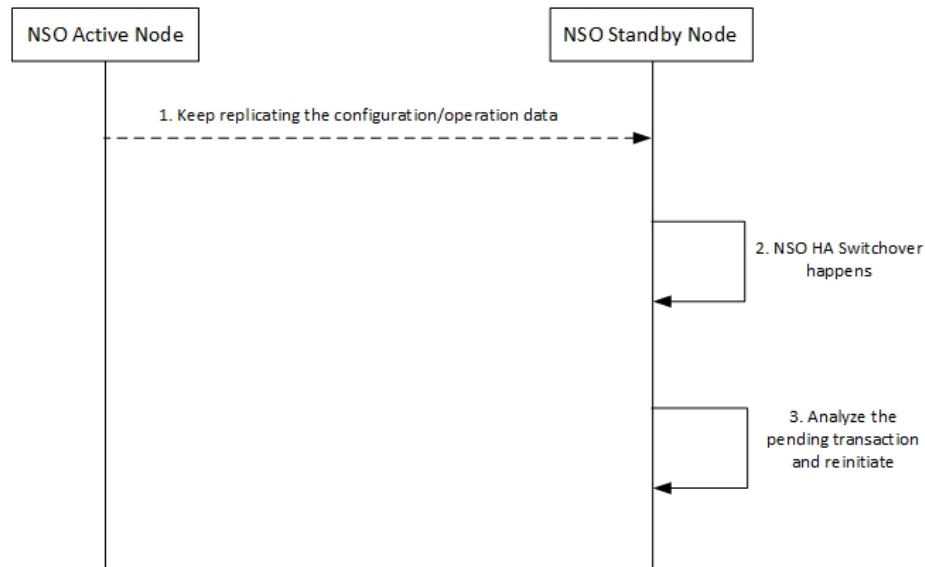

Table 40: Call Flow Description

Step	Description
1	NSO Standby Node keeps replicating the configuration or operation data from the NSO Active Node.
2	NSO HA switchover happens at the NSO Standby Node.
3	NSO Standby Node analyses the pending transaction and reinitiates the process.

Recovery

To recover from fault state to previous state, NSO provides in-built rollback mechanism for the pushed configurations. The following options are available for pushing the configuration to one or more devices:

- Commit or Dry-Runs only
- Commit with Rollback generated
- Scheme of Single or Multiple transactions
- Scheme for failure-handling on multiple transactions

- Scheme for pushing only stand-by nodes, active nodes, or common

CP Switchover (1:1)

The Mobility Function Pack does not actively track the active CP. It tracks on demand, if required, when a configuration push is initiated from northbound. Any configuration pushed to either CP is expected to be stored persistently as a boot configuration on that CP.



Note You must use the MOP option to save the configuration permanently.

On a CP switchover, the CP that rebooted is expected to boot up with all the necessary configurations. The Mobility Function Pack does not perform any special handling in this scenario.

UP Switchover (1:1)

Like the CP scenario, any configuration pushed to either UP instance is saved persistently as part of the boot configuration. You must use the MOP option to save the configuration permanently. On a UP switchover, the UP that reboots are expected to come up with all the necessary configuration automatically. The Mobility Function Pack does not perform any special actions in this case.

UP Switchover (N:M)

The following figure illustrates the UP Recovery notification flow:

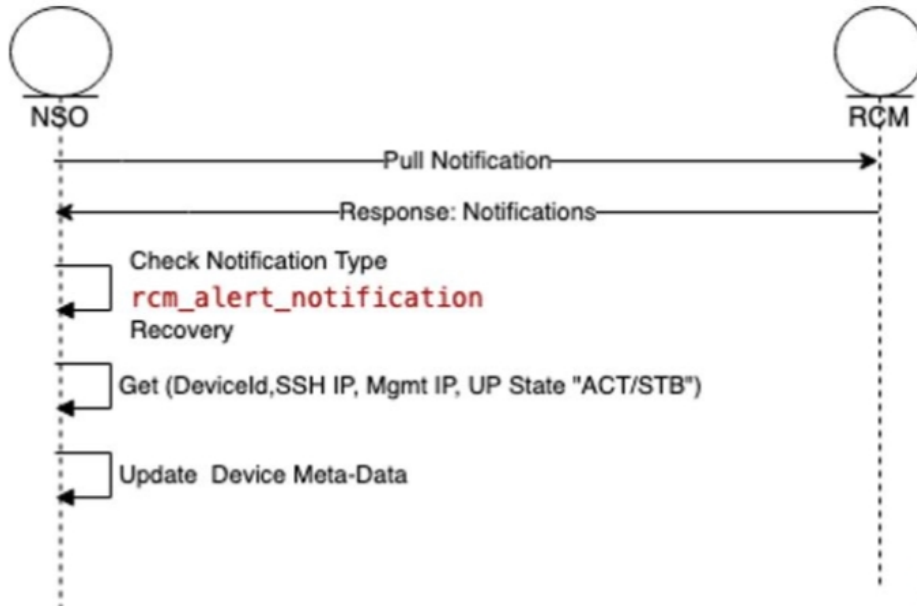

Once the NSO is subscribed to RCM device notification, NSO gets all notifications published to the stream “rcm-alert-notification”.

NSO performs the following steps whenever there is UP Recovery notification:

1. Waits for alert-status “Recovery”

2. Gets device details (Device Name, SSH IP, Management IP, UP Status)
3. Updates the device meta-data in NSO

Out-of-Band Configuration

A fundamental aspect of NSO-based configuration management is that the NSO maintains a copy of each device's (VNFs) configuration. When any configuration changes are applied from Northbound, the NSO compares its local copy of the configuration with the applied configuration to determine precisely what configuration needs to be pushed into the device. For this to occur, the NSO's copy of the configuration has to be in-sync with the actual configuration on the device/VNF.

There can be reasons due to which VNF configuration may be performed out-of-band, bypassing the NED. For example, any Day-0 configuration necessarily precedes onboarding the device into the NSO and thus is out-of-band (it is pushed through the appropriate VNF Manager). The configuration push MOP performs a "sync-from" operation prior to pushing any configuration to a device. This ensures that the NSO pulls any out-of-band configuration into the NSO's local copy, and the attempted configuration push is applied to the most current device configuration. The sync-from can only pull configuration that is known to the NED. Also, there are caveats when dealing with encrypted data.

Sensitive Elements in Configuration

StarOS encrypts sensitive elements in the configuration like passwords, keys, and so on. The encrypted items can only be decrypted by StarOS and are thus opaque to the NSO. Furthermore, the encrypted form of the sensitive item can change even when the underlying cleartext does not. As a result, the NSO cannot reliably detect any out-of-band changes made to such items.

The recommendation is to either:

- Completely manage the corresponding configuration out-of-band

—Or—

- Use only the NSO to manage the corresponding configuration, meaning the cleartext form of the command must be configured into NSO from Northbound initially, and for every subsequent change.

Do not mix NSO-based configuration management and out-of-band management for the same configuration.

Lawful Intercept

Lawful Intercept (LI) can be configured in a couple of different ways. One deployment involves all LI configuration in a single context (without using the dedicated LI context feature), and providing the general system administrator with LI administrator privileges. The other deployment involves a dedicated LI context, segregated LI configuration, and a dedicated LI administrator separate from general system administrator. There are other variations that likely fall in-between.

For the NSO to be able to manage LI configuration, it needs to:

- Have LI privileges and general system administrator privileges
- Be able to view and pull LI configuration in cleartext

For the deployment that involves all LI configuration in a single context scenario, the NSO must manage the LI configuration. For the other cases, it is recommended that the LI configuration be maintained out-of-band and provided as part of Day-0 configuration.

CUPS Configuration MOP

The Configuration MOP is the Method of Procedure (MOP) by which Configuration is applied to Cisco StarOS devices or RCM. This operation is invoked by network operator and in response, NSO provides the unique task-id for the request. Later, network operator can poll NSO using task-id to retrieve the status.

Configuration MOP broadly consists of the following three steps:

1. Device onboarding
2. Prepopulating Config metadata
3. Configuration push through Mobility MOP

Device Onboarding

The Device onboarding step is required only for the devices which are instantiated or orchestrated outside the Mobility orchestration solution. Otherwise, the instantiated VNF is implicitly onboarded onto the NSO as a device by the NSO-based Mobility orchestration solution.



Note This step is required only for the first time. Subsequent configuration pushes should skip this step.

The following examples illustrate how to onboard the VNF using RESTCONF or CLI respectively.

RESTCONF

Patch request for NSO URL: `http://<NSO-IP>:<PORT>/restconf/data`

The following is an example configuration:

```
{
  "data": {
    "nfv-device-onboarding:nfv-devices": {
      "device": [
        {
          "name": "<Device-or-VNF-Name>",
          "address": "<Management-Address>",
          "username": "<Management-Username>",
          "password": "<Management-Password>",
          "ned-type": "<cisco-staros/RCM>",
          "retry-options": {
            "number-of-attempts": <no-of-attempts-to-ping>,
            "delay": <delay-between-pings>
          }
        }
      ]
    }
  }
}
```

The following is an example configuration:

```
{
  "data": {
    "nfv-device-onboarding:nfv-devices": {
      "device": [
        {
          "name": "vpc-si25",
          "address": "209.165.200.225",
          "username": "admin",
          "password": "Cisco@123",
          "ned-type": "cisco-staros",
          "retry-options": {
            "number-of-attempts": 2,
            "delay": 10
          }
        }
      ]
    }
  }
}
```

CLI

You can also create/populate onboarding of the device using the following NSO CLI commands:

configure

```
nfv-devices device device_name address ip_address username user_name password
password ned-type cisco-staros retry-options delay delay_value
number-of-attempts value
commit
```

The following is an example configuration:

```
nfv-devices device dummy-device address 209.165.200.225 username admin password cisco@123
ned-type cisco-staros retry-options delay 10 number-of-attempts 2
```

Existing device in NSO can be deleted using the Delete request URL, no payload:

```
http://<NSO-IP>:<NSO-PORT>/restconf/data/nfv-device-onboarding:nfv-devices/device=<device-name>
```

It can also be deleted using NSO CLI:

configure

```
no nfv-devices device device_name
commit
```

Prepopulating Configuration Metadata

The configuration push MOP allows for variable substitution. This is useful in cases where nearly identical configuration is pushed to multiple devices (for example an ICSR active/standby pair). The differences can be represented as variables in the input configuration file. You can then populate the specific values for each device as metadata in a "variable: value" format. The MOP dynamically substitutes the right variable values at runtime.

If there are no prepopulated data for the device, Config MOP assumes that there are no dynamic substitution variables in config files, which are given for configuration push. If any attribute values that are referred in config files are missing, this step fails at runtime.

Prepopulating of config metadata has the following structure, and population of this data is based on the network scheme and data set. Highlighted items are mandatory for config push, and other items are optional.

```
container metadata-store{
    list config-metadata {
        key device-name;

        leaf device-name {
            tailf:info "onboarding device name";
            type string;
        }

        leaf schema {
            tailf:info "cluster-topology 1:1, N:M and N+2";
            type string;
        }

        list attributes {
            key attribute-name;

            leaf attribute-name {
                tailf:info "Attribute Name";
                type string;
            }

            leaf attribute-value {
                tailf:info "Attribute Value";
                type string;
            }
        }

        list configuration-type {
            key config-type;
            tailf:info "Configuration type Day0.5, Day1 or DayN";
            leaf config-type {
                type string;
            }
        }
    }
}
```

```
        list files {
            key file-name;
            tailf:info "file name";
            leaf file-name {
                type string;
            }
            leaf config-scheme {
                type string;
            }
        }
    // CP device info
    list additional-files {
        key device; //cp device
        leaf device{
            tailf:info "device name";
            type string;
        }
    }
    list additional-file{
        key additional-file-name;
        leaf additional-file-name{
            tailf:info "file name";
            type string;
        }
    }
}
}
```

Configuration meta-data is populated using the configuration meta-data request. This request follows the following YANG schema. The items in the "input" section are to be provided by the operator. The "output" section represents what is returned by the NSO after execution the action request.

The following is an example of NSO action to populate or modify the config meta-data:

```

tailf:action config-metadata-request {
    tailf:info "Invoke upgrade action on the selected devices";
    tailf:actionpoint config-metadata-request;
    input {
        list config-metadata {
            key device-name;
            leaf device-name {
                tailf:info "onboarding device name";
                type string;
            }

            list attributes {
                key attribute-name;
                leaf attribute-name {
                    tailf:info "Attribute Name";
                    type string;
                }
                leaf attribute-value {
                    tailf:info "Attribute Value";
                    type string;
                }
            }
        }
    }
    output {
        leaf status {
            type string;
        }
    }
}

```

RESTCONF

The following is an example to call this action from RESTCONF:

URI:

`http://<NSO-IP>:<NSO-REST-PORT>/restconf/data/mobility-common:config-metadata/config-metadata-request`

Content-Type: application/yang-data+json

Payload:

```

{
    "config-metadata": {
        "device-name": "test2",
        "schema": "1:1",
        "attributes": {
            "attribute-name": "hostname",
            "attribute-value": "TEST"
        },
        "attribute-name": "BACKHAUL_IP",
        "attribute-value": "209.165.200.225"
    }
}

```

Result:

```
{
  "mobility-common:output": {
    "status": "Success"
  }
}
```

CLI

The following is an example to call this action using NCS CLI:

```
ubuntu@ncs> request config-metadata config-metadata-request config-metadata { device-name
staros-1 attributes { attribute-name hostname attribute-value TEST }
status Success
[ok][2021-07-12 08:05:01]
```

Configuration Push through Mobility MOP

This step is the final step in the configuration MOP. It allows you to push a fresh configuration or rollback a previously pushed configuration. The configuration to be pushed is present in one or more files as mentioned previously

Configuration MOP Push Request Flow

Network Operator invokes NSO API to start the process of config MOP automation for devices

NSO performs the below steps:

- Perform check-sync and sync-from or partial sync (if required) for the device. The check-sync determines if the NSOs copy of the device configuration is already in-sync with the actual device configuration.
- If specified in the MOP, NSO replaces the device attributes (variables) with node specific values read from device tree of the config metadata.
- NSO applies the configuration from the input files specified in the MOP to the device or list of devices in the order specified in the request. If there is a failure when pushing the configuration towards a device, then no further configuration is pushed to that device.
- NSO applies MOP(s) based on the mop type provided in the request (active/standby/common).

- If the mop type is “common”, then NSO applies MOP(s) for all the devices provided in the request.

In case of a failure, configuration push to the device(s) that encountered the failure is halted. Configuration push to other devices in the request continues. The Status shows the details of the failed devices. The operator then gets the option of rolling back the configuration on the failed device(s) as a separate action.

- If the mop type is “active”, then NSO applies MOP(s) for all the “active” devices provided in the request

The mop type “active” applies only to 1:1 redundancy scenario.

In case of a failure, any pushed configuration is rolled back.

- If the mop type is “standby”, then NSO applies MOP(s) for all the “standby” devices provided in the request.

The mop type “standby” applies only to 1:1 redundancy scenario.

In case of a failure, any pushed configuration is rolled back.

- If the mop type is “pair”, then NSO applies MOP(s) first on the “standby” device and if successful, MOP(s) is applied on the “active” device. It performs the atomic transaction, so the configuration is applied to either both or neither device.

The mop type “pair” applies only to 1:1 redundancy scenario.

In case of a failure, any applied configuration is rolled back from both instances of the pair.

- If the mop type is “rcm-upf”, then NSO applies MOP(s) on the input device. Additionally, it identifies the RD-group of the input device and finds out the other UPF devices present in the same RD-group. Then it saves the ECS/APN config on the input device.

In case of a failure, configuration push to the device(s) that encountered the failure is halted. Configuration push to other devices in the request continues. The Status shows the details of the failed devices. The operator then gets the option of rolling back the configuration on the failed device(s) as a separate action.

- NSO generates dry-run and reverse (rollback) configuration in native format for the MOP(s) supplied and stores in two separate files. In response, NSO returns both the file names along with absolute file path to the network operator.
 - Dry-run file is named as <MOP File Name>-<Device Name>-dryrun.txt.
 - Rollback file name is named as <MOP File Name>-<Device Name>-rollback.txt. Files are generated under the task id folder.
- If the network operator sends a request only for dry-run, then NSO generates dry-run and rollback files, but does not apply the MOP towards the device.
- If the network operator sends a request to apply the MOP, NSO generates dry-run and rollback files, and then applies the MOP towards the device.
- Network operator keeps on polling NSO for MOP automation status.
- NSO returns the list of hosts (devices) along with dry-run and rollback file location, and the status (Completed/In-Progress/Failed).

Configuration MOP Rollback Request Flow

- Network Operator invokes NSO API to start the process of rollback of a previously applied configuration.
- NSO performs the following steps:
 - Perform check-sync and sync-from or partial sync (if required) for the device.
 - NSO performs the rollback of MOP files in the reverse order for the task ID, MOP file name, and device name supplied by the network operator.
- If the MOP type is “pair”, then NSO performs rollback first on the “standby” device and after successful rollback, NSO performs rollback on the “active” device.
- If only task ID is supplied, then the whole transaction is rolled back. If task ID and MOP file name(s) are supplied, then only supplied MOPs are rolled back for all the devices. If task ID, MOPs file name, and devices names are supplied, then only supplied MOP for supplied devices are rolled back.

- NSO generates dry-run and reverse (rollback) configuration in native format for the rollback to be done, and stores in files. In response, NSO returns both file names along with absolute file path to the network operator.
 - Dry-run file is named as <MOP File Name>-<Device Name>-dryrun.txt
 - Rollback file is named as <MOP File Name>-<Device Name>-rollback.txt

Files are generated under the task ID folder.

- If the network operator sends a request only for dry-run, then NSO generates dry-run and rollback files.
- If the network operator sends a request to roll back the MOP, NSO generates dry-run and rollback files, and then performs rollback.
- Network operator keeps on polling NSO for rollback status.
 - NSO returns the list of hosts (devices) along with dry-run and rollback file location, and the status (Completed/In-Progress/Failed)

MOP Automation

The Mobility configuration MOP is a set of commands that can be used to configure mobility devices from the NSO. This allows end user to specify locations to find or save the MOP-related input files and output files. It also allows the end user to setup global configurable parameters for MOP.

Configuration Prerequisites

- Navigate to NSO CLI and use static action to set the below parameters:
 1. Dry-run-mop location: Dry-run-mop file contains the configurations pushed to the device. Enter the location to save dry-run files of the MOP.
 2. Rollback-mop location: Rollback files are the configuration files generated that are required to roll back the configuration on device. Enter the location to save rollback files of the MOP.
 3. Config-mop-file location: Enter the location to fetch input configuration MOP files.
 4. Netconf-to-cli Conversion: Set the flag as “true” to convert NETCONF configuration to device CLI format. If the flag is set as “false”, then the dry-run file is generated in native NETCONF xml format.

- Static action call command in configuration:

```
static dry-run-mop /var/opt/ncs/  
static rollback-mop /var/opt/ncs/
```

To verify, use the following CLI command:

```
show full-configuration static
```

- Global parameter configuration for mop-file location:

```
configure  
configurable-parameters config-mop-file-loc /var/opt/ncs/
```

To verify, use the following CLI command:

```
show full-configuration configurable-parameters config-mop-file-loc
```

- StarOS-level NED setting examples
 1. To prevent configuration update in the system cfg boot files of the devices, ensure that the write-memory-setting is disabled in the NCS CLI using the following command:

```
devices global-settings ned-settings cisco-staros
write-memory-setting disabled
```
 2. Use the following command to exclude warnings while committing the configurations to the device:

```
devices global-settings ned-settings cisco-staros behaviour
config-warning-ignore.*Standby card not ready.*
```



Note Here, `.*Standby card not ready.*` can be replaced with the warning message to be ignored.

Mop-type Pair Prerequisites

- One of the device names, based on the identification of the device state (Active/Standby), can be specified as target-device-name.
- Configure the peer device and srp_loopback using the following commands:

```
config-metadata config-metadata-request config-metadata { device-name
up2-SI device-type vpc attributes { attribute-name srp_loopback
attribute-value 209.165.200.225 } scheme 1:1 }
config-metadata config-metadata-request config-metadata { device-name
up2-SI device-type vpc attributes { attribute-name Peer_Device_Name
attribute-value up1-SI } scheme 1:1 }
```

NSO APIs

NSO APIs are exposed by the NSO Mobility function pack that relate to configuration push functionality. These APIs are accessible either over RESTCONF or CLI.

Configuration Push MOP Automation

This API is used to start the MOP for pushing configuration to one or more devices. This is an asynchronous operation, and the status can be queried using a separate API.

API:

```
mop-automation
```

Request Details

Parameter	Format	Required	Description
mop-file-name	List	—	
file-name	String	Key	Name of the device that corresponds to the UP, CP, or RCM.

Parameter	Format	Required	Description
execution-order	Int	Mandatory	MOP execution order. 1 means first – order used is 1, 2, 3....
target-devices	List	Mandatory	Devices list
target-device-name	Leafref	Key	The NSO device name for VNF. If NSO is used for orchestration, the device name is the same as the VNF name.
operation-type	String	Mandatory	dry-run or commit

Parameter	Format	Required	Description
mop-type	Enum	—	

Parameter	Format	Required	Description
			<p>Determines which device(s) to push the configuration to. The allowed values are:</p> <ul style="list-style-type: none"> • active Push to the active instance of a 1:1 redundancy pair. You can enter the device name for one of the instances of the redundancy pair (regardless of whether it is active or standby). The MOP automatically determines the currently active instance of that pair and pushes. • standby Push to the standby instance of 1:1 redundancy pair. You can enter the device name for one of the instances of the redundancy pair (regardless of whether it is active or standby). The MOP automatically determines the currently standby instance of that pair and pushes. • pair Push to both active and standby instances of a 1:1 redundant pair. You can enter the device name for one of the instances of the redundancy pair (regardless of whether it is active or standby). The MOP automatically determines both instances of the pair using the supplied instance, pushes to the standby instance first, and then to the active instance. • common

Parameter	Format	Required	Description
			<p>Push to all devices provided in the request. This is the default.</p> <ul style="list-style-type: none">• rcm-upf <p>Push configuration to either single or all associated UPFs.</p>

Parameter	Format	Required	Description
transaction-type	Enum	—	<p>The allowed values are:</p> <ul style="list-style-type: none"> • single-transaction The configuration in all the supplied input files is combined and pushed to the device as a single transaction. • multiple-transaction Each input file is pushed to the device as a separate transaction. This is the default value. <p>A transaction is an atomic unit of configuration change. All configuration in a transaction will either be pushed successfully or will be rolled back automatically if there was a failure during the push.</p> <p>Note A transaction will not span multiple devices. Each transaction is specific to a single device.</p> <p>For example, if the operator pushes 3 files each to 2 devices, then:</p> <ul style="list-style-type: none"> • with the multiple-transactions option, a total of $3 \times 2 = 6$ transactions, one per device, per file are present. • with the single-transaction option, a total of 2 transactions, 1 per device is present.
save-config-permanently	Boolean	—	<p>The default value is "false". When set to "true", you can save the configuration to "system.cfg".</p>

Parameter	Format	Required	Description
timeout	Int	Optional; default value is 600 seconds	The maximum number of seconds to wait for the device to be locked.

Timeout Parameter

The NSO 6.0 version uses optimistic concurrency to improve parallelism. However, transaction conflicts can occur when services are executed in parallel. When a single device is configured concurrently, the initial transaction locks the device, causing subsequent transactions to fail.

The timeout parameter determines how long MFP will wait for some operations related to the device such as getting a device lock. This is relevant if there are multiple operations that push configuration to the same device simultaneously.



Note It is not recommended to configure a single device parallelly at the same time.

If the **timeout** parameter is not used while pushing config with the **mobility-mop** automation CLI or postman API, the system will automatically invoke a default value of 600 seconds.

If you want to push many configs or larger size of config, you can make a call to set the timeout value beyond the default value using the timeout parameter.

You can specify any value as shown in the following configuration example:

```
cloud-user@ncs# mobility-mop:action mop-automation generate-dry-run true operation-type
  commit save-config-permanently true mop-type common mop-file-name { file-name ABC.cfg
  order
    1 target-devices-list { target-device-name XYZ } } timeout 900
```

You can set the timeout parameter as infinity by specifying the timeout value as -1:

```
cloud-user@ncs# mobility-mop:action mop-automation generate-dry-run true operation-type
  commit save-config-permanently true mop-type common mop-file-name { file-name ABC.cfg
  order
    1 target-devices-list { target-device-name XYZ } } timeout -1
```

As soon as the config is pushed, the device is freed for another user or for another round of config push. For example, if timeout is 600 seconds and config push completes in 100 seconds, the device can be used by another user for config push after 100 seconds.

Response details

Parameter	Format	Required	Description
Task-id	String	Mandatory	Task unique identifier. The Task-id is to be used to query the status of the operation.
Time stamp	String	Mandatory	Time stamp
Error Code	String		Error Code
Error Message	String		Error Message

CLI

The following is an example of a request with NCS CLI:

```
mobility-mop:action mop-automation mop-type common transaction-type
multiple-transaction operation-type commit mop-file-name { file-name
dayN.txt order 1 target-devices-list { target-device-name up2-SI } }
```

REST API Request – Without Specifying Transaction Type

The following is an example of REST API request using postman without specifying the transaction type:

```
POST /restconf/data/mobility-mop:action/mop-automation
Host: localhost:8080
Authorization: Basic YWRtaW46YWRtaW4= Content-Type: application/vnd.yang.data+json
cache-control: no-cache

{
  "mop-automation": {
    "operation-type": "commit",
    "mop-type": "active",
    "generate-dry-run": "true",
    "save-config-permanently": "true",
    "mop-file-name": [
      {
        "file-name": "up_dayN.txt" ,
        "order": 1,
        "target-devices-list": [
          {
            "target-device-name": "up2-SI"
          }
        ]
      }
    ]
  }
}
```

REST API Request – With Specifying Transaction Type

The following is an example of REST API request with specifying the transaction type:

```
POST /restconf/data/mobility-mop:action/mop-automation
Host: localhost:8080
Authorization: Basic YWRtaW46YWRtaW4= Content-Type: application/vnd.yang.data+json
cache-control: no-cache
Postman-Token: d2d2ddb6-5dff-4917-972a-146db6dc175f

{
  "mop-automation": {
    "operation-type": "commit",
    "mop-type": "active",
    "transaction-type": "single-transaction",
    "mop-file-name": [
      {
        "file-name": "load3.txt",
        "order": 1,
        "target-devices-list": [
          {
            "target-device-name": "test3"
          }
        ]
      },
      {
        "file-name": "load4.txt",

```

```

        "order": 2,
        "target-devices-list": [
          {
            "target-device-name": "test3"
          }
        ]
      }
    ]
  }
}

```

REST API Request – Without Specifying Transaction Type and mop-type as Pair

The following is an example of REST API request without specifying the transaction type and mop-type as pair:

```

{
  "mop-automation": {
    "operation-type": "commit",
    "mop-type": "pair",
    "generate-dry-run": "true",
    "save-1-1-config": "true",
    "mop-file-name": [
      {
        "file-name": "up_dayN.txt" ,
        "order": 1,
        "target-devices-list": [
          {
            "target-device-name": "up2-SI"
          }
        ]
      }
    ]
  }
}

```

In response to successful invocation of above asynchronous requests, a unique task-id and time stamp is returned which is used to check the status of the mop-automation request.

```

{
  "mobility-mop:output": {
    "task-id": "1a1f62f0-487a-4c8c-bdeb-a760c26925cc",
    "time-stamp": "2021-07-19T11:10:51+0000",
    "time-zone": "Coordinated Universal Time"
  }
}

```

MOP Automation with mop-type as rcm-upf

Mop-type rcm-upf is used to push configuration to either single or all associated UPFs. The following two scenarios are applicable:

1. Apply MOP on single UPF.

The following are ways to specify the UPF device:

- Specify the upf-device in target-device-name.
- Specify the rcm-vip, group, and device-id corresponding to upf-device.

For the above two ways, the “only-to-target-devices” must set to “true” in the request.

Payload Examples:

a. Specify the upf-device in target-device-name:

```
{
  "mop-automation": {
    "operation-type": "commit",
    "mop-type": "rcm-upf",
    "generate-dry-run": "true",
    "save-config-permanently": "true",
    "only-to-target-devices": "true",
    "mop-file-name": [
      {
        "file-name": "simpleStarOsChange.txt",
        "order": 1,
        "target-devices-list": [
          {
            "target-device-name": "up1-device"
          }
        ]
      }
    ]
  }
}
```

b. Specify the rcm-vip, group, and device-id corresponding to upf-device:

```
{
  "mop-automation": {
    "operation-type": "commit",
    "mop-type": "rcm-upf",
    "generate-dry-run": "true",
    "save-config-permanently": "true",
    "only-to-target-devices": "true",
    "mop-file-name": [
      {
        "file-name": "simpleStarOsChange.txt",
        "order": 1,
        "rcm-vip" : "rcmvip01",
        "group" : "group03",
        "device-id" : "device-id1"
      }
    ]
  }
}
```

2. Apply MOP on all the associated UPF devices.

The following are the ways to identify the UPF devices:

- Specify a sample upf-device in target-device-name.
- Specify a rcm-vip and group.

Payload Examples:

a. Specify a sample upf-device in target-device-name:

```
{
  "mop-automation": {
    "operation-type": "commit",
    "mop-type": "rcm-upf",
    "generate-dry-run": "true",
    "save-config-permanently": "true",
    "only-to-target-devices": "false",
    "mop-file-name": [

```

```

        {
            "file-name": "simpleStarOsChange.txt",
            "order": 1,
            "rcm-vip" : "rcmvip01",
            "group" : "group03"
        }
    ]
}

```

b. Specify a rcm-vip and group.

```

{
  "mop-automation": {
    "operation-type": "commit",
    "mop-type": "rcm-upf",
    "generate-dry-run": "true",
    "save-config-permanently": "true",
    "only-to-target-devices": "false",
    "mop-file-name": [
      {
        "file-name": "simpleStarOsChange.txt",
        "order": 1,
        "rcm-vip" : "rcmvip01",
        "group" : "group03"
      }
    ]
  }
}

```

For the above two ways, the “only-to-target-devices” must be set to “false” in the request.

To retrieve the UPF device using rcm-vip and group, the data available in the following lists in CDB are used:

- device-id-up-mapping
- up-rcm-mapping
- rcm-upf-mapping

MOP Automation Status

NSO provides device status results for the task-id passed by the network operator.

API:

mop-automation-status

Request details

Parameter	Format	Required	Description
Task-id	String	Mandatory	Task unique identifier obtained from the "MOP Automation" API.

Response details

Parameter	Format	Required	Description
task-id	String	key	Task ID

Parameter	Format	Required	Description
task-status	String		Task status
Start-date	String		Start Date Time
End-date	String		End Date Time
Time-zone	String		Time zone
Operation-type	String		Commit/Dry-run
Action-type	String		Save
devices-list	list		Devices
Device-name	leafref	key	Device name
Start-date	String		Start Date Time
End-date	String		End Date Time
device-status	leafref		Device Status (Completed/In-Progress/Failed)
device-state	String		Active/Standby/Common /Pair/rcm-upf
files	list		Files
file-name	String	key	MOP file name
Order	Uint8		Order in which MOP has been performed
dry-run-mop	String		Dry-run output file location
rollback-mop	String		Rollback MOP location
Commit-queue-status	String		Commit queue status
Commit-queue-id	String		Commit queue ID
Error Code	String		Error Code
Error Message	String		Error Message
Error Code	String		Error Code
Error Message	String		Error Message

CLI

The following is an example of a request with NCS CLI:

```
mobility-mop:action mop-automation-status task-id  
8d08e359-0bd2-48de-9a34-9192a986a486
```

REST API Request

The following is an example of REST API request to know the status of the mop-automation:

```
POST /restconf/data/mobility-mop:action/mop-automation-status  
Host: localhost:8080
```

```

Authorization: Basic YWRtaW46YWRtaW4= Content-Type: application/vnd.yang.data+json
cache-control: no-cache

{
  "task-id": "22301071-9a6c-4f27-a0dc-b50c24124806"
}

```

The following is an example of response format generated, post invocation of the above request:

```

{
  "mobility-mop:output": {
    "task-id": "8d08e359-0bd2-48de-9a34-9192a986a486",
    "task-status": "COMPLETED",
    "start-date": "2021-09-06T09:08:54+0000",
    "end-date": "2021-08-06T09:09:10+0000",
    "time-zone": "Coordinated Universal Time",
    "operation-type": "commit",
    "action-type": "save",
    "devices-list": [
      {
        "device-name": "up2-SI",
        "device-status": "COMPLETED",
        "start-date": "2021-08-06T09:08:55+0000",
        "end-date": "2021-08-06T09:08:59+0000",
        "device-state": "active",
        "files": [
          {
            "file-name": "up_dayN.txt",
            "order": "1",
            "dry-run-mop":
"/var/opt/ncs//8d08e359-0bd2-48de-9a34-9192a986a486/up2-SI/up_dayN_commit_2021-08-06T090854+0000.txt",
            "rollback-mop":
"/var/opt/ncs//8d08e359-0bd2-48de-9a34-9192a986a486/up2-SI/up_dayN_rollback_commit_2021-08-06T090854+0000.txt",
            "commit-queue-status": "completed",
            "commit-queue-id": "1628240937590"
          }
        ]
      }
    ]
  }
}

```

MOP Rollback

NSO starts the process of rollback for task ID, MOP file, and devices provided in the input of the request.

This is the only option to roll back the MOP-configured configs or rolled-back configs.

This API rolls back a previously applied configuration. This uses the rollback files creating while originally applying the configuration. Rollback can be done per file, or for all files, and per device, or for all devices.



Note The success of a rollback is highly dependent on what changes have been made to the system since the relevant configuration was pushed. Subsequent changes may have changed the system such that the rollback configuration may not make sense.

API:

mop-rollback

Request details

Parameter	Format	Required	Description
Task-id	String	Mandatory	Task Unique Identifier
mop-file-name	List	Optional	MOP files along with device
file-name	String	Key	The original file name, used for identifying the corresponding rollback file.
target-devices	List	Optional	Device list. If not provided, the rollback is performed on all devices to which configuration was pushed in the original transaction.
target-device-name	Leafref	Key	
operation-type	String	Mandatory	Dry-run/Commit
timeout	Int	Optional; default value is 600 seconds	The maximum number of seconds to wait for the device to be locked.

Response details

Parameter	Format	Required	Description
Task-id	String	Mandatory	Task unique identifier. The task-id is to be used to check the status of the rollback via a separate API.
Time stamp	String	Mandatory	Time stamp
Error Code	String	Error Code	
Error Message	String	Error Message	

CLI

The following is an example of a request with NCS CLI:

```

mobility-mop:action mop-rollback task-id
8d08e359-0bd2-48de-9a34-9192a986a486 generate-dry-run true operation-type
commit save-config-permanently true mop-file-name { file-name up_dayN.txt
target-devices-list { target-device-name up2-SI } }

```

REST API Request – With Operation Type “commit”

The following is an example of REST API request with operation-type "commit":

REST API Request – With Operation Type “dry-run”

```

POST /restconf/data/mobility-mop:action/mop-rollback
Host: localhost:8080
Authorization: Basic YWRtaW46YWRtaW4= Content-Type: application/vnd.yang.data+json
cache-control: no-cache
Postman-Token: 1b687031-dc32-41 14-a69f-5984130c36a5
{
  "mop-rollback": {
    "task-id": "0891655c-642b-4ba3-9392-6f05d4e77a63",
    "operation-type": "commit",
    "generate-dry-run": "true",
    "save-config-permanently": "true",
    "mop-file-name": [
      {
        "file-name": "up_dayN.txt",
        "target-devices-list": [
          {
            "target-device-name": "up2-SI"
          }
        ]
      }
    ]
  }
}

```

In response to a successful invocation of above request, a unique task-id and time stamp is returned which is used to check the status of the mop-rollback request.

```

{
  "mobility-mop:output": {
    "task-id": "8d08e359-0bd2-48de-9a34-9192a986a486",
    "time-stamp": "2021-08-06T09:08:44+0000",
    "time-zone": "Coordinated Universal Time"
  }
}

```

REST API Request – With Operation Type “dry-run”

The following is an example of REST API request with operation-type "dry-run":

```

POST /restconf/data/mobility-mop:action/mop-rollback
Host: localhost:8080
Authorization: Basic YWRtaW46YWRtaW4= Content-Type:
application/vnd.yang.data+json cache-control: no-cache
Postman-Token: 1b687031-dc32-41 14-a69f-5984130c36a5
{
  "mop-rollback": {
    "task-id": "0891655c-642b-4ba3-9392-6f05d4e77a63",
    "operation-type": "dry-run",
    "generate-dry-run": "true",
    "save-config-permanently": "true",
    "mop-file-name": [
      {
        "file-name": "up_dayN.txt",
        "target-devices-list": [
          {
            "target-device-name": "up2-SI"
          }
        ]
      }
    ]
  }
}

```

In response to a successful invocation of above request, a unique task-id and time stamp is returned which is used to check the status of the mop-rollback request.

```
{
  "mobility-mop:output": {
    "task-id": "1a1f62f0-487a-4c8c-bdeb-a760c26925cc",
    "time-stamp": "2021-07-19T11:10:51+0000",
    "time-zone": "Coordinated Universal Time"
  }
}
```

MOP Rollback Status

NSO provides device status results for the task-id passed by the network operator. API to query the status of an ongoing or completed rollback operation.

API:

mop-rollback-status

Request details

Parameter	Format	Required	Description
Task-id	String	Mandatory	Task unique identifier of the rollback operation.

Response details

Parameter	Format	Required	Description
task-id	String	key	Task unique identifier
task-status	String		Task status
Start-date	String		Start Date Time
End-date	String		End Date Time
Time-zone	String		Time zone
Operation-type	String		Commit/Dry-run
Action-type	String		Rollback
devices-list	list		Devices
Device-name	leafref	key	Device name
Start-date	String		Start Date Time
End-date	String		End Date Time
device-status	leafref		Device Status (Completed/In-Progress/Failed)
device-state	String		Active/Standby/Common/Pair
files	list		Files
file-name	String	key	MOP file name
Order	UInt8		Order in which MOP has been performed
dry-run-mop	String		Dry run output file location

Parameter	Format	Required	Description
rollback-mop	String		Rollback MOP location
Commit-queue-status	String		Commit queue status
Commit-queue-id	String		Commit queue ID
Error Code	String		Error Code
Error Message	String		Error Message
Error Code	String		Error Code
Error Message	String		Error Message

CLI

The following is an example of a request with NCS CLI:

```
mobility-mop:action mop-rollback-status task-id  
fd0fb9ae-8685-420e-9490-0c6858d14148
```

REST API Request

The following is an example of REST API request to know the status of the mop-rollback:

```
POST /restconf/data/mobility-mop:action/mop-rollback-status
Host: localhost:8080
Authorization: Basic YWRtaW46YWRtaW4= Content-Type: application/vnd.yang.data+json
cache-control: no-cache
Postman-Token: Oe2c4bd3-2dc6-4ddb-aea9-1 1 Occf622da7
"mop-rollback -status": {
"task-id": "5733d661-9242-4867-8320-a314da592c93"
}
```

```
Below is response format generated, post invocation of the above request -
task-id fd0fb9ae-8685-420e-9490-0c6858d14148
task-status COMPLETED
start-date 2021-08-06T09:24:14+0000
end-date 2021-08-06T09:24:30+0000
time-zone Coordinated Universal Time
operation-type commit
action-type rollback
devices-list {
  device-name up2-SI
  device-status COMPLETED
  start-date 2021-08-06T09:24:14+0000
  end-date 2021-08-06T09:24:19+0000
  device-state active
  files {
    file-name up_dayN_rollback_commit_2021-08-06T090854+0000.txt
    order 1
    dry-run-mop /var/opt/ncs//fd0fb9ae-8685-420e-9490-0c6858d14148/up2-SI
/up_dayN_2021-08-06T090854+0000_rollback_commit_2021-08-06T092414+0000.txt
    rollback-mop /var/opt/ncs//fd0fb9ae-8685-420e-9490-0c6858d14148/up2-SI
/up_dayN_2021-08-06T090854+0000_commit_2021-08-06T092414+0000.txt
    commit-queue-status completed
    commit-queue-id 1628241856973
  }
}
```

Verifying the dry-run and Reverse dry-run MOP

To verify the dry-run MOP and reverse dry-run MOP, go to respective file location which was provided while configuring static data for dry-run MOP and reverse dry-run MOP.

Adding Variables to Configuration File for MOP Execution

The MOP automation package supports specifying variables in the MOP so that they are populated at runtime based on what device the MOP is being applied to. For example, if the following MOP was specified and was executed on device TXPCF003:

```
config context local administrator $Host_name password Nsotest123$ exit
end
```

The Host Name can be configured using the following action call:

```
config-metadata config-metadata-request config-metadata { device-name
up2-SI device-type vpc attributes { attribute-name Host_name
attribute-value TXPCF003} scheme 1:1 }
```

The dry-run MOP that would be generated is as follows:

```
config context local administrator TXPCF003 password Nsotest123$ exit end
```

UP Configuration Push and Recovery in N:M Redundancy

In the N:M scenario, the RCM determines the role of each UP (active versus standby). Since any of the M standby instances must be capable of taking over for any of the N active instances, the configurations to be pushed are different and dynamic. This also means not all configuration can be saved on the UPs persistently.

RCM issues NETCONF notifications for relevant events such as a UP booting up or UP switchover. NSO listens to those notifications and applies the necessary configuration as appropriate.

The configuration for a UP consists of the following logical components:

- Day-0 configuration: This is primarily basic configuration for the UP's management interface to be reachable. This is pushed at the time of UP deployment by the VNF. This configuration is expected to be persistent across reboot.



Note

The require

```
rcm-configmgr CLI
```

command must be configured on the UP as part of Day-0 configuration for the NSO-based configuration push to work. This command is required irrespective of whether RCM is used in the solution or not. Without configuring this command, the ECS configuration push appears hidden.

- Day-0.5 configuration: This is configuration that allows the UP to contact the RCM. This configuration can be pushed either along with day 0, or pushed separately from the NSO, either automatically, right after UP deployment (if NSO is deploying the VM), or by a manual execution of the config push MOP. This configuration is also expected to be saved persistently across reboots.
- Common configuration: This is configuration that is common to all UPs regardless of whether they are active or standby. This is ECS and APN configuration only. This configuration needs to be pre-populated

in the NSO. NSO will push this upon receiving notifications from the RCM. This configuration is not saved persistently as part of the boot configuration but is saved locally as a file on each UP and re-applied on every reboot by the NSO automatically.

- **Host-specific configuration:** This is configuration that is unique to each active UP. This is primarily the various service IP addresses. Each active UP is pushed the configuration specific to that active instance. Each standby instance is pushed the combined host-specific configurations of all active UPs. This configuration is expected to be pre-populated on the NSO. NSO will push this to each UP as appropriate based on the notification from the RCM.
- **Host-specific configuration - RCM copy:** This is the host-specific configuration of each UP, however, formatted in RCM compatible format. This needs to be pushed to the RCM. While RCM is not involved in configuration for the most part, it is still involved in performing config negation during UP switchover. Config negation means removing the configuration of all the other active UPs from the standby UP that is about to take over for a given active UP. So, say, in a 3:1 scenario, Active3 UP goes, down. The standby has the host-specific configurations of Active1, Active2, and Active3. Since the standby now takes over for Active3, the RCM negates the configs of Active1 and Active2 from that standby as part of the switchover.

NETCONF Notification Subscription on NSO

All notifications sent from RCM are captured by NSO. NSO filters the notifications and handles RCM related notifications.

The following table explains the possible types of RCM UP notifications, and how they are handled by NSO.

	Recovery	Config-Push	
	UP Recovery	UP Reboot	New UP
Active UP	Update Device meta-data in NSO.	Push host specific config. If common config is not on device, re-push the common config file. Update device meta-data in NSO.	
Standby UP	N/A	Push all hosts specific config. If common config is not on device, re-push the common config file. Update device meta-data in NSO.	

Handle RCM UP Recovery Notification

In case of UP failure, RCM detects the failure via BFD Manager, and pushes the notification, which is received by NSO. RCM handles the switchover of the UP to make an elected standby UP to an active one. This configuration management process for the standby UP to switchover does not take much time because the standby UP already has all the required configuration.

The following figure illustrates the RCM UP notification handling:

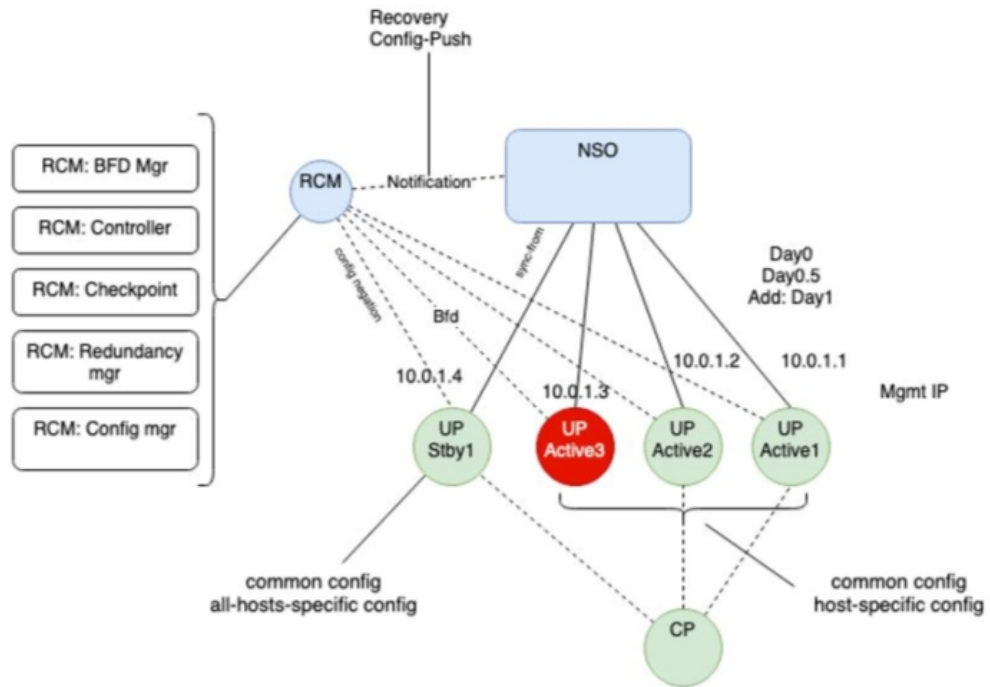

RCM UP Config-Push Notification

RCM generates config-push notification if there is a new UP coming up or existing UP is rebooting for recovery.

The following figure illustrates the RCM UP Configuration Push notification handling

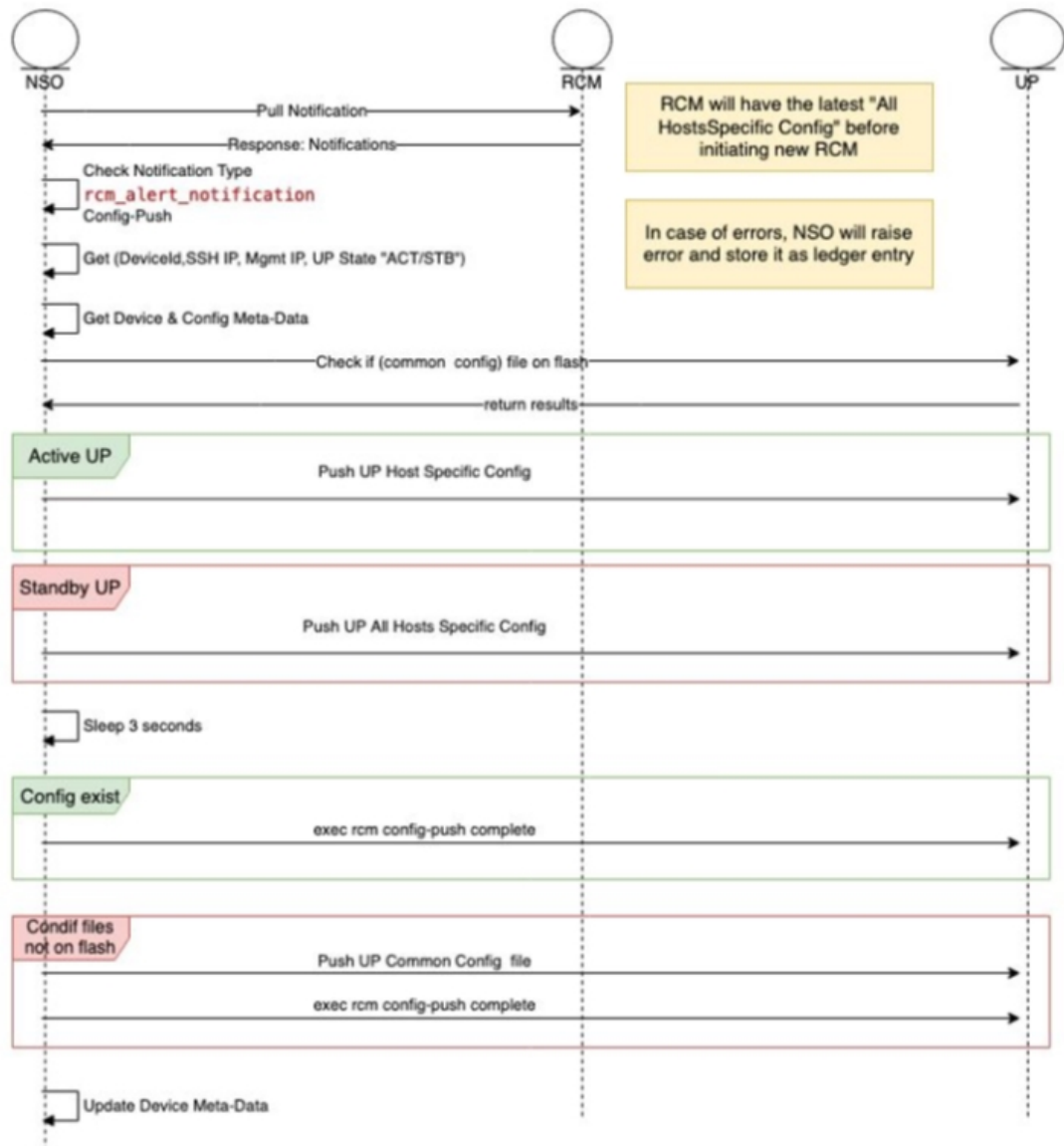

NSO performs the following steps whenever there is UP Config-Push notification:

1. Waits for alert-status “config-push”
2. Gets the device details (Device Name, SSH IP, Management IP, UP Status)
3. Gets the device meta-data from NSO
4. Checks if common file exists in UP flash.
5. If the UP State is Active, NSO pushes the UP host specific config file using the Mobility MOP.
6. If the UP State is Standby, NSO pushes the UP all hosts specific config file using the Mobility MOP.
7. Sleeps for 3 seconds.
8. If the common config file exists, NSO applies it by running live-status command on UP

9. If the common config file doesn't exist, NSO pushes the common config file to the UP using the Mobility MOP, and then applies it by running live-status command on UP.
10. Updates the device meta-data in NSO.

UP Day-0.5 Update

To change UP Day-0.5 configurations, UP must be rebooted which requires UP to be down during the change. RCM supports this use case through a command to force sending of notification whenever a specific UP gets rebooted. This notification triggers NSO to push the new Day-0.5 configurations.

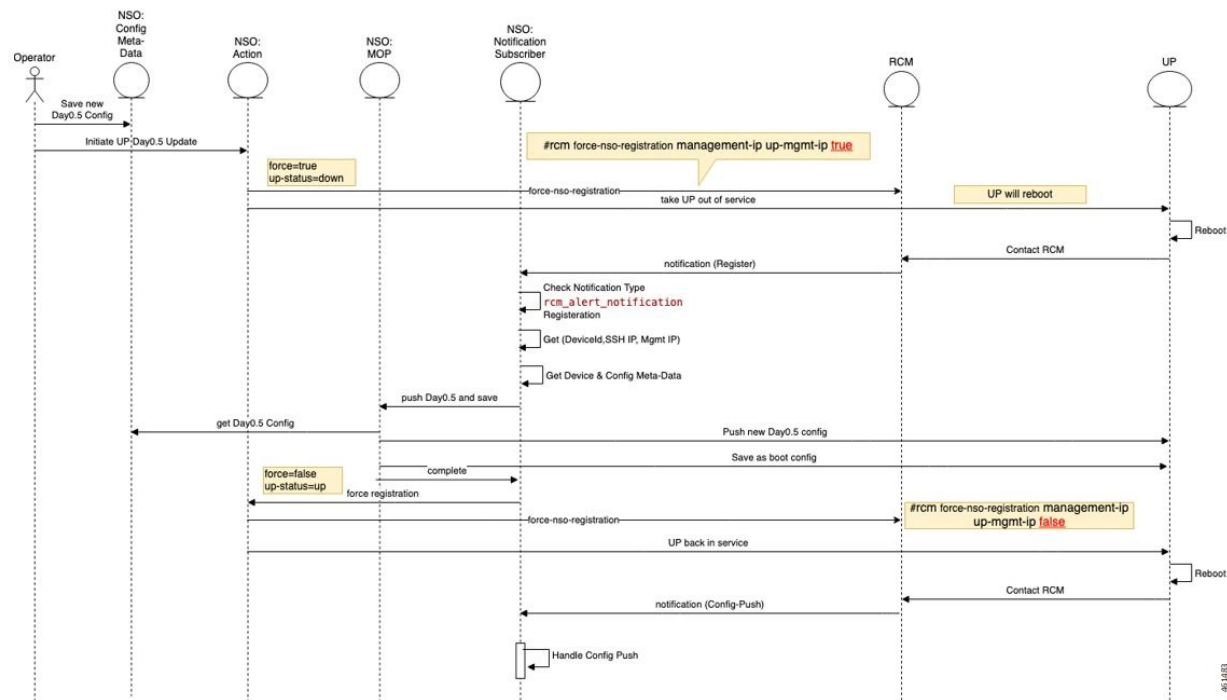

1. You must update the UP Day-0.5 configuration in NSO config-metadata.
2. You must start the UP Day-0.5 change action by providing the UP device-name and management IP address.
3. NSO Action runs RCM command to force NSO registration when the UP reboots:

```
rcm force-nso-registration management-ip MGMT-IP true
```
4. NSO action brings down the UP, which can be one of the following two scenarios:
 - a. Standby UP: NSO action runs reload command on UP.
 - b. Active UP: NSO Action runs planned switchover command on RCM by providing the UP management-ip as well as the Standby UP management-ip. The Standby UP management-ip can be retrieved from NSO Device-Metadata of the UP Group
5. After UP reboot (Active or Standby UP), RCM generates notification of type "Registration" which is received by the NSO.

6. After NSO RCM Subscriber receives the Registration notification, it starts new MOP process to push Day-0.5 configuration for the target UP.
7. NSO RCM Subscriber keeps pulling the MOP Status. After the MOP is completed, NSO runs the following command UP:

```
rcm-config-push-complete
```
8. NSO RCM Subscriber calls the NSO Action to disable the force-notification command by running the following command:

```
rcm force-nso-registration management-ip MGMT-IP false
```
9. NSO Action brings up the UP by running the reload command.
10. After the UP reboots, RCM generates the Config-Push notification, which is handled by NSO as usual.

Prerequisites for Configuration Push

The following are some prerequisites for config-push:

1. For UPs, the

```
require rcm-configmgr
```

 CLI command must be preconfigured as part of Day-0 configuration. This is required for N:M, 1:1, and standalone scenarios. This enables appropriate behavior of ECS configuration.
2. For UPs, PFD push must be disabled from the CPs and in the UPs, wherever applicable. All UP configurations are pushed from the NSO directly. This is applicable for N:M, 1:1, and standalone scenarios.
3. The RCM OpsCenter Configuration mode CLIs must be configured as follows:

```
k8 smf profile rcm-config-ep config-mode NSO
k8 smf profile rcm-config-ep switchover deployment false
```
4. There are some default StarOS NED settings that must be overridden:
 - a. Any configuration change is automatically saved to the devices boot configuration (system.cfg). This is not desirable when N:M redundancy is used as the configuration of a UP changes depends on its role. This must be disabled globally using the following CLI configuration command:

```
devices global-settings ned-settings cisco-staros
write-memory-setting disabled
```

 If using only 1:1 or standalone deployments, then this setting can be left as is.
 If using a mix of N:M and 1:1/standalone, then disable config save as above, and then fuse the "save-config-permanently" parameter in any manual configuration push for 1:1/standalone. For automated configuration pushes, the mobility function pack automatically saves the configuration whenever required.
 - b. The NED treats any warnings as errors and fails the configuration push. In a lot of cases, the warnings can be ignored, and the configuration push needs to proceed. The NED can be configured to ignore select warnings using a regular expression for that warning. Here's an example.

```
devices global-settings ned-settings cisco-staros behaviour
config-warning-ignore .*not recommended to change the dictionary.*
```

Some of the other common ones are:

```
ned-settings cisco-staros behaviour config-warning-ignore .*About
to overwrite boot.*
```

```
ned-settings cisco-staros behaviour config-warning-ignore .*Standby
card not ready.*
```

This last one is required for configuration push to SIs.

- RCM supports the concept of an SSH IP. An SSH IP is a way to unambiguously track a given Active UP regardless of which VM is serving that function. The NSO-based solution does not use SSH IPs. However, the solution requires configuration of a dummy SSH IP. This is configured as a secondary IP address in the management interface. To avoid any errors in this configuration, the following setting is recommended as part of Day-0.5

configure

```
redundancy-configuration-module rcm rcm
```

```
nso-ssh-ip context local interface-name local1 mask 255.255.255.224
```

- Read and write operations from the NSO to the VNFs can take more or less time depending on the latency. These are tunable as shown below. Do this only if you see issues with read or write errors that are truly due to latency. Typically, default settings should suffice.

```
devices global-settings read-timeout 180
```

```
devices global-settings write-timeout 180
```

Limitations and Restrictions

The NSO-based Configuration Management feature has the following limitations in this release:

- Production NSO instance can run only on popular Linux flavors (for example, RedHat, Cisco Linux, Ubuntu, CentOS, and so on).
- Only Day-1 configuration is pushed for UP on RCM notifications. No other configurations are pushed.
- For pushing Day-N configuration change at a later point, you must merge that change with the Day-1 configuration files for it to be automatically pushed on an RCM notification going forward.
- If there are changes to pre-populated configuration files, they aren't pushed automatically. It's required to push them manually for all target devices. The configuration changes only for next auto-push is considered.

For N:M UPs, the pre-populated configuration files must be preserved on the NSO (both instances if running as an HA pair) if there is at least one VNF using them.

- Only configuration commands are supported. The show CLI commands within configuration files aren't supported.
- Any configuration, to be managed from the NSO, must be understood by the corresponding NED (StarOS NED for CPs, UPs, and RCM NED for RCMs). Currently, not all StarOS configuration commands are supported—only the most used configurations in CUPS field deployments are supported. Support for any missing commands requires a newer NED.

- Support of native StarOS CLI is not 100%. While majority of the supported CLI commands are acceptable in native StarOS CLI format, there are some cases where the NSO accepts only a variant of the corresponding StarOS CLI. Such CLIs are documented in [Appendix A: Incompatible StarOS Native Command Syntax, on page 523](#). You can use the "dry-run" functionality of the configuration MOP to detect any errors due to incompatible/unsupported CLI prior to performing a configuration push.
- A configuration push may fail if the NSO handling the request goes down during the operation. This is applicable for both manual and automated configuration push. It is also applicable for both NSO HA and standalone NSO deployments. Operator intervention may be required depending on the exact nature of the failure.
- The Day-0.5 configuration change workflow for the N:M redundancy scenario is not fully functional in this release. For this release, the workaround is to:
 1. Remove the UP from the redundancy group (making it Standby first, if it was Active)
 2. UP boots up with Day-0 and current Day-0.5 configuration
 3. Make the Day-0.5 configuration change on the UP and save it persistently as the boot configuration
 4. Add the UP back to the redundancy group. The UP registers with the RCM and the remaining configurations are pushed by NSO automatically
- In this release, the Day-N configuration push in the N:M redundancy scenario requires a prior extra step if active-charging configuration changes are pushed using the rcm-upf MOP type. It is required to manually delete the file `/flash/mobility_production.cfg` on all the UPs in that redundancy group prior to invoking the MOP.
- The standard StarOS CLI NED stores certain sensitive configuration data as cleartext locally. Access to this can be restricted by using the NACM rules on the NSO. If there are additional concerns with this, contact your Cisco Account representative for a version of the NED that encrypts this sensitive data locally. Note that this encryption is specific to the NED and NSO. StarOS encrypts sensitive data on its own—the two encryptions are separate. When NSO encrypts the sensitive data locally, it decrypts it prior to transmitting it to StarOS device (it is sent over SSH, so it is encrypted in transit, but is received by StarOS CLI as cleartext).
- For the N:M redundancy scenario, RCM supports a concept of an SSH IP. The NSO-based solution does not use the SSH IP. However, for the FCS (3.0.0 and 21.25), there is a requirement to specify an SSH IP for the solution. Any address, including private, non-routable address will suffice. This address is configured as a secondary address on the management interface of the UPs. Also refer to the [Prerequisites for Configuration Push, on page 520](#) section for a note on the SSH IP configuration requirements for the UP.

Troubleshooting

The following options are available for troubleshooting purposes:

1. Use the dashboard output for the task-id for available details. For example:

```
mobility-mop:action mop-automation-status task-id 12d5fc33-2f9e-44e3-81e3-14043d4ee39d
```

2. In case of failures, some alarms may be raised. These can be viewed using the

```
show alarms
```

CLI command.

- Detailed logs can be viewed by examining `/var/log/ncs/ncs-java-vm.log` file. However, this is oriented towards developer debugging.

Appendix A: Incompatible StarOS Native Command Syntax

This section identifies the commands that are already supported in the NED (tagged in Bold below) but not compatible with StarOS native command syntax.

Mode	Command	Comments
context xxx/ggsn-service yyy	ip qos-dscp qci 9 af31 gtpc af41	It accepts "ip qos-dscp qci 9 af31" and "ip qos-dscp gtpc af41" separately. When it pushes to device, it pushes as combined.
context xxx/apn yyy	apn fnetcoriolis default max-contexts default cc-roaming default ipv6 address alloc-method exit	It accepts "no max-contexts", "no cc-roaming", and "no ipv6 address alloc-method" and generates "default xxx" towards the device.
context xxx/crypto map yyy (ikev2-pv4)/payload zzz match ipv4	crypto map ipsec_tunnel ikev2-ipv4 keepalive interval 4 timeout 1 num-retry 4 payload mypayload match ipv4 default lifetime exit	It accepts "no lifetime" and generates "default lifetime" towards the device.
active-charging service xxx/credit-control group yyy/	credit-control group cc-m2mpt quota validity-time 600 diameter reauth-blacklisted-content content-based-rar default diameter send-ccru on-rar always default diameter mscc-per-ccr-update exit	It accepts "no xxx" and generates "default xxx" towards the device.

Mode	Command	Comments
context xxx/ikev2-ikesa transform-set yyy	ikev2-ikesa transform-set transformset_li default encryption default group default hmac default lifetime default prf exit	It accepts "no xxx" and generates "default xxx" towards the device.
global config mode	end and #exit	rload does not accept these commands.
global config mode	snmp trap enable	Equivalent is: no snmp trap suppress
active-charging service xxx/ruledef yyy Or any command that has "!" in it	active-charging service ecs ruledef rd-webredirect-apn-sl2sfr bearer 3gpp imsi !range imsi-pool imsi-NOREDIRECT exit	rload does not recognize the "!" character unless it is enclosed in double-quotes or escaped with backslash.
active-charging service xxx/ruledef yyy Any URL with %NN in it	ruledef rd l www url = http://itunes.apple.com/WebObjects/MZStore.woa/wa/viewSoftware%3f id=362713555& exit	The %3f must be escaped with a "\"

Mode	Command	Comments
context xxx/gtp group yyy	gtp group sgw no gtp attribute node-id no gtp attribute losdv no gtp trigger time-limit no gtp trigger tariff-time-change no gtp trigger serving-node-change-limit no gtp trigger inter-plmn-sgsn-change no gtp trigger qos-change no gtp trigger rat-change no gtp trigger ms-timezone-change no gtp trigger uli-change	StarOS does not handle these commands as a default setting, whereas NED does.
context xxx/ims-auth-service yyy	p-cscf table 1 row-precedence 1 ipv4-address 209.165.200.227 secondary ipv4-address 209.165.200.229	The highlighted keyword must be changed to ipv4-address only for the secondary IP address.
context xxx/ims-auth-service yyy	default signaling-flag	Use "no signaling-flag" instead.
context xxx/ims-auth-service yyy	default traffic-policy general-pdp-context no-matching-gates direction downlink	Use "no traffic-policy general-pdp-context no-matching-gates direction downlink" instead.
context xxx/ims-auth-service yyy	p-cscf table 1 row-precedence 1 ipv6-address 2001:860:fff:feb6::a secondary ipv6-address 2001:860:fff:feb4::9	The highlighted keyword must be changed to ipv6-address only for the secondary IP address.
context xxx/hexdump-module	default file rotation volume time-stamp monitor- subscriber-file-name	Equivalent is: no file rotation volume no file time-samp no file monitor-subscriber-file-name
context xxx/hexdump-module	default file rotation volume	Equivalent is: no file rotation volume
context xxx/hexdump-module	default file time-stamp	Equivalent is: no file time-stamp

Mode	Command	Comments
context xxx/hexdump-module	default subscriber-file-name	Equivalent is no subscriber-file-name
context xxx/hexdump-module	default hexdump transfer-mode	Equivalent is: no hexdump transfer-mode
context xxx/hexdump-module	default hexdump push-interval	Equivalent is: no hexdump push-interval
context xxx/edr-module active-charging-service	default cdr transfer-mode push via transfer-mode	Equivalent is: no cdr transfer-mode push
context xxx/session-event-module	default event transfer-mode push via transfer-mode	Equivalent is: no event transfer-mode push
context xxx/router bgp NNN	context gy router bgp 64650 neighbor 209.165.200.226 remote-as 15557 no neighbor 209.165.200.226 capability graceful-restart	StarOS default setting is to have graceful-restart capability. NED handles these commands the reverse way. Note This CLI is supported from StarOS CLI NED version 5.50 onwards.

Appendix B: Example Configurations for N:M Deployment with RCM

Host-specific Configuration-UP

The following are examples of host-specific configurations for two Active UPs. These are pushed to the respective UPs.

First Active UP

```
config
context EPC2
interface loop1_up1 loopback
ip address 209.165.200.225 255.255.255.224

interface loop2_up1 loopback
ip address 209.165.200.226 255.255.255.224

interface loop3_up1 loopback
ip address 209.165.200.227 255.255.255.224
```

```
interface loop4_up1 loopback
ip address 209.165.200.228 255.255.255.224

interface loop5_up1 loopback
ip address 209.165.200.229 255.255.255.224

exit
exit

context EPC2
sx-service sx_up1
instance-type userplane
bind ipv4-address 209.165.200.229
exit

exit
exit

context EPC2
gtpu-service pgw-gtpu_up1
bind ipv4-address 209.165.200.226
exit
gtpu-service saegw-sxu_up1
bind ipv4-address 209.165.200.227
exit
gtpu-service sgw-engress-gtpu_up1
bind ipv4-address 209.165.200.228
exit
gtpu-service sgw-ingress-gtpu_up1
bind ipv4-address 209.165.200.225

exit
exit
config
context EPC2
user-plane-service up_up1
associate gtpu-service pgw-gtpu_up1 pgw-ingress
associate gtpu-service sgw-ingress-gtpu_up1 sgw-ingress
associate gtpu-service sgw-engress-gtpu_up1 sgw-egress
associate gtpu-service saegw-sxu_up1 cp-tunnel
associate sx-service sx_up1
associate fast-path service
associate control-plane-group g1
exit

exit
exit
```

Second Active UP

```
config
context EPC2
interface loop1_up2 loopback
ip address 209.165.200.230 255.255.255.224

interface loop2_up2 loopback
ip address 209.165.200.231 255.255.255.224

interface loop3_up2 loopback
ip address 209.165.200.232 255.255.255.224

interface loop4_up2 loopback
ip address 209.165.200.233 255.255.255.224
```

```

interface loop5_up2 loopback
ip address 209.165.200.234 255.255.255.224

exit
exit

context EPC2
sx-service sx_up2
instance-type userplane
bind ipv4-address 209.165.200.234
exit

exit
exit

context EPC2
gtpu-service pgw-gtpu_up2
bind ipv4-address 209.165.200.231
exit
gtpu-service saegw-sxu_up2
bind ipv4-address 209.165.200.232
exit
gtpu-service sgw-egress-gtpu_up2
bind ipv4-address 209.165.200.233
exit
gtpu-service sgw-ingress-gtpu_up2
bind ipv4-address 209.165.200.230

exit
exit

context EPC2
user-plane-service up_up2
associate gtpu-service pgw-gtpu_up2 pgw-ingress
associate gtpu-service sgw-ingress-gtpu_up2 sgw-ingress
associate gtpu-service sgw-egress-gtpu_up2 sgw-egress
associate gtpu-service saegw-sxu_up2 cp-tunnel
associate sx-service sx_up2
associate fast-path service
associate control-plane-group g1
exit

exit
exit

```

Host-specific Configuration-RCM

The following are examples of host-specific configurations for RCM. This is pushed to the RCM.

First Active RCM

```

config
control-plane-group g1
  redundancy-group 1
    host Active1
    peer-node-id ipv4-address 209.165.200.240
  exit
exit
exit
context EPC2
interface-loopback loop1_up1
  redundancy-group 1

```

```
    host Active1
      ipv4-address 209.165.200.224/27
    exit
  exit
exit
interface-loopback loop2_up1
  redundancy-group 1
    host Active1
      ipv4-address 209.165.201.0/27
    exit
  exit
exit
interface-loopback loop3_up1
  redundancy-group 1
    host Active1
      ipv4-address 209.165.202.128/27
    exit
  exit
exit
interface-loopback loop4_up1
  redundancy-group 1
    host Active1
      ipv4-address 192.0.2.0/24
    exit
  exit
exit
interface-loopback loop5_up1
  redundancy-group 1
    host Active1
      ipv4-address 198.51.100.0/24
    exit
  exit
exit
user-plane-service up_up1
  redundancy-group 1
    host Active1
      associate control-plane-group g1
      associate fast-path service
      associate sx-service sx_up1
      associate gtpu-service pgw-gtpu_up1 pgw-ingress
      associate gtpu-service saegw-sxu_up1 cp-tunnel
      associate gtpu-service sgw-engress-gtpu_up1 sgw-egress
      associate gtpu-service sgw-ingress-gtpu_up1 sgw-ingress
    exit
  exit
exit
gtpu-service pgw-gtpu_up1
  redundancy-group 1
    host Active1
      bind ipv4-address 209.165.201.0
    exit
  exit
exit
gtpu-service saegw-sxu_up1
  redundancy-group 1
    host Active1
      bind ipv4-address 209.165.202.128
    exit
  exit
exit
gtpu-service sgw-engress-gtpu_up1
  redundancy-group 1
    host Active1
      bind ipv4-address 192.0.2.0
```

```

    exit
  exit
exit
gtpu-service sgw-ingress-gtpu_up1
  redundancy-group 1
  host Active1
  bind ipv4-address 198.51.100.123
  exit
exit
sx-service sx_up1
  redundancy-group 1
  host Active1
  bind ipv4-address 198.51.100.0
  instance-type userplane
  exit
exit
exit
exit

```

Second Active RCM

```

config
control-plane-group g1
  redundancy-group 1
  host Active2
  peer-node-id ipv4-address 209.165.200.240
  exit
exit
context EPC2
  interface-loopback loop1_up2
  redundancy-group 1
  host Active2
  ipv4-address 209.165.200.224/27
  exit
  exit
  interface-loopback loop2_up2
  redundancy-group 1
  host Active2
  ipv4-address 209.165.201.0/27
  exit
  exit
  interface-loopback loop3_up2
  redundancy-group 1
  host Active2
  ipv4-address 209.165.202.128/27
  exit
  exit
  interface-loopback loop4_up2
  redundancy-group 1
  host Active2
  ipv4-address 192.0.2.0/24
  exit
  exit
  interface-loopback loop5_up2
  redundancy-group 1
  host Active2
  ipv4-address 198.51.100.0/24
  exit

```



```

exit
exit
user-plane-service up_up2
  redundancy-group 1
    host Active2
      associate control-plane-group g1
      associate fast-path service
      associate sx-service sx_up2
      associate gtpu-service pgw-gtpu_up2 pgw-ingress
      associate gtpu-service saegw-sxu_up2 cp-tunnel
      associate gtpu-service sgw-engress-gtpu_up2 sgw-egress
      associate gtpu-service sgw-ingress-gtpu_up2 sgw-ingress
    exit
  exit
exit
gtpu-service pgw-gtpu_up2
  redundancy-group 1
    host Active2
      bind ipv4-address 209.165.201.0
    exit
  exit
exit
gtpu-service saegw-sxu_up2
  redundancy-group 1
    host Active2
      bind ipv4-address 209.165.202.128
    exit
  exit
exit
gtpu-service sgw-engress-gtpu_up2
  redundancy-group 1
    host Active2
      bind ipv4-address 192.0.2.0
    exit
  exit
exit
gtpu-service sgw-ingress-gtpu_up2
  redundancy-group 1
    host Active2
      bind ipv4-address 198.51.100.123
    exit
  exit
exit
sx-service sx_up2
  redundancy-group 1
    host Active2
      bind ipv4-address 198.51.100.0
      instance-type userplane
    exit
  exit
exit
exit

```

Common Configuration

The following is an example of a common configuration. This is pushed to all Active UPs and all Standby UPs.

```

config
active-charging service ACS
idle-timeout udp 60
statistics-collection ruledef all
host-pool IPv6_VoLTE_Phone_Host_7

```

```

ip 209.165.200.224/27
ip 64:ff9b::d3f6:6b00/120
ip 2001:e60:6000::/46
ip 2001:e60:6004::/46
ip range 209.165.200.225 to 209.165.200.234
ip range 64:ff9b::e00:4f12 to 64:ff9b::e00:4f14
ip range 64:ff9b::3d6e:ff52 to 64:ff9b::3d6e:ff59
ip range 64:ff9b::d3f6:682c to 64:ff9b::d3f6:683e
exit
port-map M_learning_Port
port range 1 to 9500
port range 10001 to 30000
exit
port-map OTM_Advertisement_port
port 90
port 9090
exit
ruledef ICMP
ip protocol = 1
exit
ruledef ICMPv6
ip protocol = icmpv6
exit
ruledef IPv6_VoLTE_Phone_1
udp either-port range port-map M_learning_Port
ip server-ip-address range host-pool IPv6_VoLTE_Phone_Host_7
exit
ruledef RD-allTraffic
ip any-match = TRUE
exit
ruledef RD_Charge
ip server-ip-address = 209.165.201.0/27
exit
ruledef catchall
ip any-match = TRUE
exit
ruledef googles
icmpv6 any-match = TRUE
exit
ruledef qcil
tcp any-match = TRUE
exit
ruledef route-ims-ipv6-nexthop
ip uplink = TRUE
ip version = ipv6
exit
ruledef optIn
ip any-match = TRUE
exit
group-of-ruledefs GoR_FOTA
add-ruledef priority 1 ruledef FOTA_SAMSUNG
add-ruledef priority 2 ruledef FOTA_LG
add-ruledef priority 3 ruledef FOTA_LG_2
add-ruledef priority 5 ruledef FOTA_PANTECH_2
add-ruledef priority 8 ruledef IOS_OTA_Update
add-ruledef priority 9 ruledef GOTA_google
add-ruledef priority 10 ruledef FOTA_Hybrid_Egg
add-ruledef priority 11 ruledef FOTA_SAMSUNG_2
add-ruledef priority 12 ruledef FOTA_SAMSUNG_3
add-ruledef priority 13 ruledef FOTA_SAMSUNG_4
add-ruledef priority 15 ruledef FOTA_SAMSUNG_5
add-ruledef priority 16 ruledef FOTA_LG_4
add-ruledef priority 17 ruledef FOTA_LG_5
add-ruledef priority 18 ruledef FOTA_HUAWEI_Egg

```

```

add-ruledef priority 20 ruledef KTF_DMS_FOTA
add-ruledef priority 21 ruledef FOTA_Nlabs
add-ruledef priority 22 ruledef FOTA_LTE_Beam
add-ruledef priority 23 ruledef FOTA_S_Mobile
add-ruledef priority 24 ruledef FOTA_Giga_Genie
add-ruledef priority 100 ruledef SAMSUNG_SKT_issue
add-ruledef priority 104 ruledef new_FOTA_Pantech
add-ruledef priority 106 ruledef new_FOTA_KTtech
add-ruledef priority 107 ruledef new_IOS_OTA_Log
add-ruledef priority 114 ruledef new_FOTA_LG_3
add-ruledef priority 200 ruledef IoT_FOTA_mexus
add-ruledef priority 201 ruledef IoT_FOTA_acnt
add-ruledef priority 202 ruledef IoT_FOTA_amtel
exit
packet-filter qcil
ip protocol = 1
ip remote-port = 1001
priority 1
exit
packet-filter subscriber-pools
exit
charging-action CA-nothing
content-id 5
exit
charging-action CA_Chargeable_2
content-id 1
billing-action egcdr
exit
charging-action CA_Charge
exit
charging-action DSI
billing-action egcdr
flow action discard
tft packet-filter permit_all
exit
charging-action call
service-identifier 22
billing-action egcdr
cca charging credit
flow action discard
flow limit-for-bandwidth id 4
exit
charging-action catchall
content-id 10
billing-action egcdr
cca charging credit rating-group 10 preemptively-request
exit
charging-action qcil
billing-action egcdr
cca charging credit rating-group 1 preemptively-request
qos-class-identifier 1
tft packet-filter qcil
exit
bandwidth-policy bw-policy
flow limit-for-bandwidth id 2 group-id 2
flow limit-for-bandwidth id 4 group-id 4
flow limit-for-bandwidth id 10 group-id 12
flow limit-for-bandwidth id 562 group-id 562
group-id 2 direction downlink peak-data-rate 225280 peak-burst-size 2253 violate-action
discard
group-id 4 direction uplink peak-data-rate 450560 peak-burst-size 4506 violate-action
discard
group-id 10 direction uplink peak-data-rate 1153434 peak-burst-size 11534 violate-action
discard

```

```

group-id 11 direction uplink peak-data-rate 10000 peak-burst-size 10000 violate-action
discard
exit
rulebase 5G-DF
tcp packets-out-of-order timeout 30000
no retransmissions-counted
edr sn-charge-volume count-dropped-units
bandwidth default-policy bw-policy
exit
rulebase RB-allTraffic
action priority 100 ruledef RD-allTraffic charging-action CA_Charge
egcdr threshold interval 3600
egcdr threshold volume total 4000000
exit
rulebase RB_Charge
action priority 10 ruledef RD_Charge charging-action CA_Charge
exit
rulebase cisco
billing-records egcdr
action priority 12 ruledef catchall charging-action catchall monitoring-key 123
egcdr threshold interval 120
egcdr threshold volume total 1000000
exit
rulebase cisco_dynamic
action priority 11 dynamic-only ruledef qcil charging-action qcil
action priority 10000 ruledef catchall charging-action catchall
egcdr threshold interval 120
egcdr threshold volume total 100000
exit
rulebase P2P
transactional-rule-matching
dynamic-rule order first-if-tied
tethering-detection application ip-ttl value 62
flow end-condition timeout normal-end-signaling session-end charging-edr flow-edr
billing-records egcdr
edr transaction-complete http charging-edr http-edr
flow control-handshaking charge-to-application all-packets
egcdr threshold interval 3600
egcdr threshold volume total 4000000000
no cca quota retry-time
cca diameter requested-service-unit sub-avp volume cc-total-octets 5000
p2p dynamic-flow-detection
no tft-notify-ue-def-bearer
exit
rulebase default
exit
rulebase wap_adult
transactional-rule-matching
tcp mss 1320 limit-if-present
flow end-condition handoff timeout normal-end-signaling session-end charging-edr
flow-edr
billing-records egcdr radius
action priority 28 ruledef catchall charging-action CA_Chargeable_2
action priority 29 ruledef catchall charging-action CA_Chargeable_2
edr transaction-complete http charging-edr http-edr
flow control-handshaking charge-to-application mid-session-packets tear-down-packets

egcdr threshold volume total 3000000
#exit
service-scheme ssl
exit
credit-control group DCCA_grpl
diameter origin endpoint Gy
diameter peer-select peer minid-Gy

```

```

pending-traffic-treatment noquota buffer
pending-traffic-treatment quota-exhausted buffer
pending-traffic-treatment validity-expired pass
exit
credit-control group default
pending-traffic-treatment noquota pass
pending-traffic-treatment quota-exhausted buffer
exit
policy-control charging-rule-base-name active-charging-rulebase
policy-control burst-size auto-readjust duration 3
exit
context ecs
apn cisco.com
ip context-name ecs
exit
apn starent.com
ip context-name ecs
exit
end

```

Standby Configuration (Active1 + Active2)

```

config
context EPC2
interface loop1_up1 loopback
ip address 198.51.100.123 255.255.255.224

interface loop2_up1 loopback
ip address 209.165.201.0 255.255.255.224

interface loop3_up1 loopback
ip address 209.165.202.128 255.255.255.224

interface loop4_up1 loopback
ip address 192.0.2.0 255.255.255.224

interface loop5_up1 loopback
ip address 198.51.100.0 255.255.255.224

exit
exit

context EPC2
sx-service sx_up1
instance-type userplane
bind ipv4-address 198.51.100.0
exit

exit
exit

context EPC2
gtpu-service pgw-gtpu_up1
bind ipv4-address 209.165.201.0
exit
gtpu-service saegw-sxu_up1
bind ipv4-address 209.165.202.128
exit
gtpu-service sgw-engress-gtpu_up1
bind ipv4-address 192.0.2.0
exit
gtpu-service sgw-ingress-gtpu_up1
bind ipv4-address 198.51.100.0

```

```

exit
exit

context EPC2
user-plane-service up_up1
associate gtpu-service pgw-gtpu_up1 pgw-ingress
associate gtpu-service sgw-ingress-gtpu_up1 sgw-ingress
associate gtpu-service sgw-engress-gtpu_up1 sgw-egress
associate gtpu-service saegw-sxu_up1 cp-tunnel
associate sx-service sx_up1
associate fast-path service
associate control-plane-group g1
exit

exit
exit

config
context EPC2
interface loop1_up2 loopback
ip address 209.165.200.230 255.255.255.224

interface loop2_up2 loopback
ip address 209.165.200.231 255.255.255.224

interface loop3_up2 loopback
ip address 209.165.200.232 255.255.255.224

interface loop4_up2 loopback
ip address 209.165.200.233 255.255.255.224

interface loop5_up2 loopback
ip address 209.165.200.234 255.255.255.224

exit
exit

context EPC2
sx-service sx_up2
instance-type userplane
bind ipv4-address 209.165.200.234
exit

exit
exit

context EPC2
gtpu-service pgw-gtpu_up2
bind ipv4-address 209.165.200.231
exit
gtpu-service saegw-sxu_up2
bind ipv4-address 209.165.200.232
exit
gtpu-service sgw-engress-gtpu_up2
bind ipv4-address 209.165.200.233
exit
gtpu-service sgw-ingress-gtpu_up2
bind ipv4-address 209.165.200.230

exit
exit

context EPC2

```

```
user-plane-service up_up2
associate gtpu-service pgw-gtpu_up2 pgw-ingress
associate gtpu-service sgw-ingress-gtpu_up2 sgw-ingress
associate gtpu-service sgw-engress-gtpu_up2 sgw-egress
associate gtpu-service saegw-sxu_up2 cp-tunnel
associate sx-service sx_up2
associate fast-path service
associate control-plane-group g1
exit

exit
exit
```



CHAPTER 60

NSO Orchestration for 4G CUPS

- [Feature Description, on page 539](#)
- [Use Cases, on page 539](#)
- [How it Works, on page 540](#)
- [Installing NSO Packages, on page 546](#)
- [VNF Orchestration/Deployment and Automatic Configuration Management, on page 547](#)
- [Appendix A: YANG definition of VNF, on page 569](#)
- [Appendix B: Generic Upgrade Steps of Mobility Function Pack \(MFP\), on page 576](#)
- [Appendix C: P2P Priority Upgrade, on page 582](#)

Feature Description

The Cisco Network Service Orchestrator (NSO) based VNF orchestration enables you to manage the lifecycle of newly created Virtual Network Function (VNF) devices such as CP, UP, and RCM.

The Cisco NSO Orchestration for 4G CUPS solution provides the following functions:

- Instantiation via NSO CLI, Web-Interface, or NSO RESTCONF API
- Onboarding of VNF devices such as CP, UP, and RCM upon successful instantiation
- Pushing of Day-0.5, and Day-1 CUPS configuration after successful instantiation
- Decommission of the VNF devices

Use Cases

The NSO orchestration solution caters to the following use cases:

1. Instantiation of new CP, UP, and RCM

Instantiating new 4G-based VNFs (CPs, UPs, or RCMs) for CUPS. CP can be a Virtualized Packet Core-Single Instance (VPC-SI) or Virtualized Packet Core-Distributed Instance (VPC-DI), but UP can only be a VPC-SI.

Users are notified if there are any failures.

2. Termination of CP, UP, and RCM

Terminating 4G-based VNFs (CPs, UPs, or RCMs) for CUPS.

Users are notified if there are any failures.

3. Updating current status on the VNF dashboard

Providing the current status on the dashboard of VNFs.

4. Configuration of logical group for CP, UPs, and RCMs

Configuring device group in NSO to group the CP, UPs, and RCMs, and adding the corresponding VNFs to the device group.

How it Works

Architecture

The Cisco NSO orchestration engine software modules handle the Network Functions Virtualization Orchestrator (NFVO) functions. The NFV solution follows the ETSI NFV Management and Orchestration (MANO) model, as shown in the following figure.

Figure 34: NFV Solution Architecture

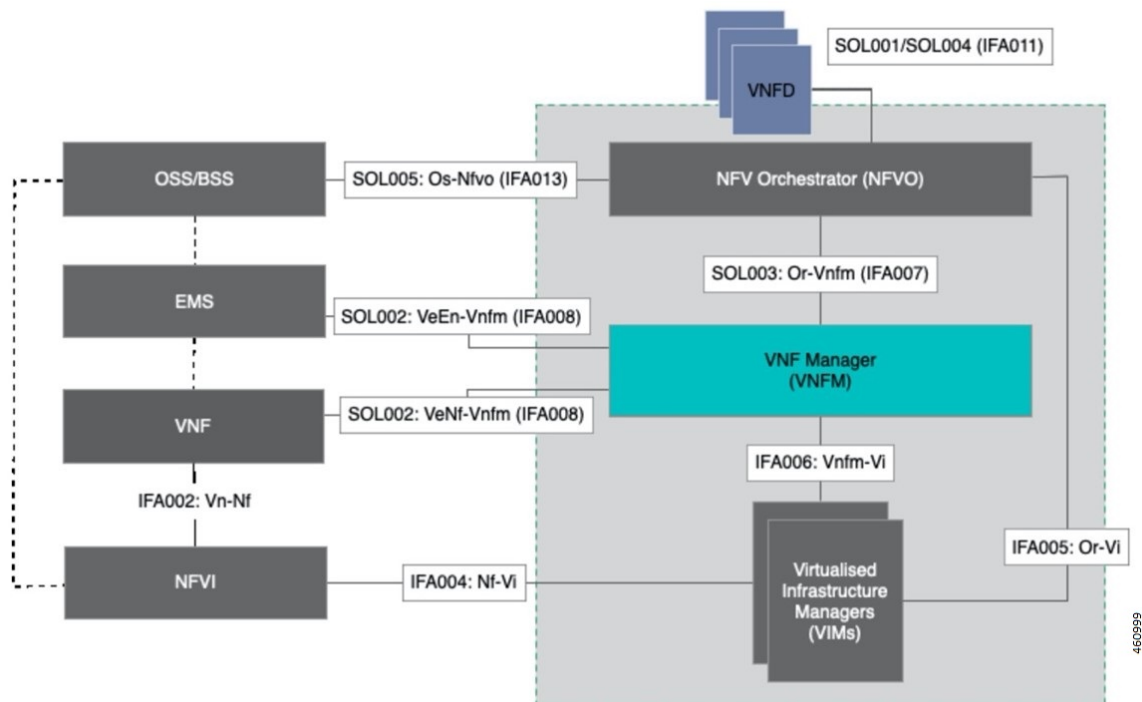

The following diagram illustrates, at a high-level, the components and frameworks involved in the solution.

Figure 35: NFV Solution Components

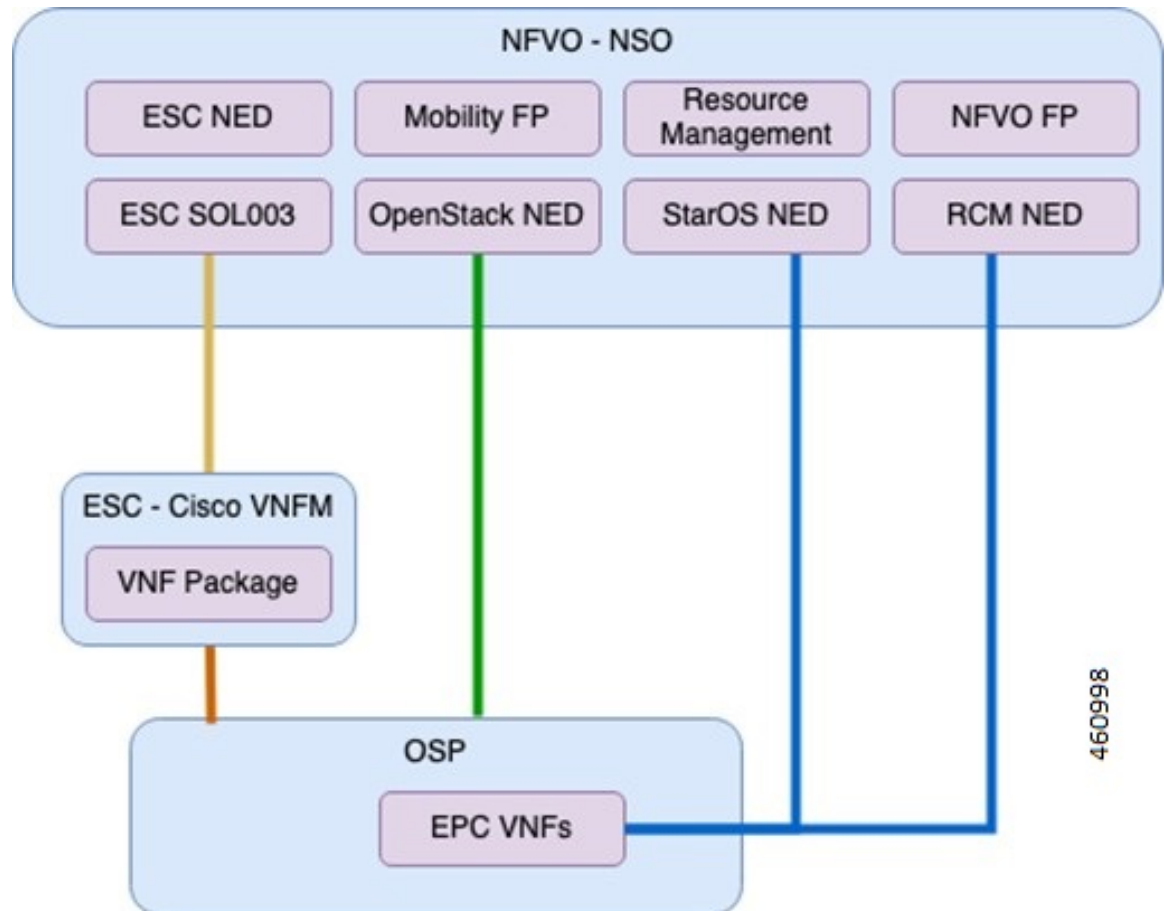

Components

The following are some of the important components of NSO:

- **Cisco NFVO Functional Pack:**

Cisco NFVO Functional Pack contains the YANG models according to the MANO specification (SOL006).

Cisco NFVO Functional Pack contains models for **cisco-etsi-nfvo**, which implements the instantiation logic of MANO descriptors on VNF Managers (VNFM) and OpenStack. Virtual Network Function (VNF) and Network Service (NS) are the main services in this package. Northbound users interact with these services to start VNFs or network services.

It also includes models for **cisco-etsi-nfvo-ro**, which contains the Resource Orchestration (RO) functionality. Resource Orchestration manages the allocation of physical resources in the Virtualized Infrastructure Managers (VIMs). These physical resources are used by a VNF or an NS.

- **StarOS NED for NSO:**

StarOS-based Network Element Driver (NED) interfaces with the Cisco 4G CUPS VNFs for configuration push.

- **RCM NED for NSO:**

RCM-based NETCONF NED is used to establish communication between NSO and RCM devices.

- **Cisco ESC SOL003 NED:**

This NED is used for ETSI SOL3 compliant devices. Elastic Services Controller (ESC) is also added as SOL3 compliant device to NSO.

- **NFV Apps Mobility Package:**

This is a custom package that provides VNF life-cycle management, and VNF dashboard update.

Minimum Platform and Software Requirements

The following are the minimum platform and software requirements to support NSO Orchestration:

- Supported VIM: OpenStack
- Supported VNFM: Cisco ESC
- Supported Orchestrator: NSO
- Network Elements:
 - RCM
 - VPC-SI (UP/CP)
 - VPC-DI (CP)

Table 41: Software Versions

Software	Minimum version
Redhat OpenStack	13 (Queens) Note VMWare or OSP 16 is not supported or validated.
Cisco ESC	5.5.0.86
Cisco NSO	6.1.6.1
OpenStack NED	4.2.30
ESC NED	5.10.0.97
StarOS NSO NED	5.52.4
Cisco NFVO FP	4.7.3
Mobility FP	3.5
NSO Resource Management	3.5.2
Cisco NSO HCC	6.0.1

This feature supports the following ETSI MANO specifications:

Table 42: ETSI MANO Specifications

Specification	Supported Version	Description
SOL001	v2.5.1	Defines the format and structure for the VNF Descriptor
SOL003	v2.4.1	Defines all interactions over the Or-Vnfm reference point

Network and Hardware Requirements

Network Requirements:

The following table demonstrates the NSO and ESC network requirements:

Table 43: NSO and ESC Network Requirements

Application	Management IP	Orchestration	Connection between HA Pair
NSO (2 VMs + VIP)	3	3	L2 connection of 100 Mbps with latency less than 30 ms
ESC (2 VMs + VIP)	3	3	L2 connection of 100 Mbps with latency less than 30 ms

Hardware Requirements

The following table demonstrates the specifications for NSO and ESC Virtual Machine to support maximum of 250 VNFs.

Table 44: NSO and ESC VM Specifications

Application	Number of VMs	VM CPU Cores	VM RAM	VM Storage	VM Connectivity
NSO	2	8	16 GB RAM baseline + 10 MB RAM for every StarOS device to be supported	100 GB disk (preferably SSD)	One 10 Gbps network link
ESC	2	4	16 GB	100 GB	

Licensing

The NSO Orchestration for 4G CUPS is a licensed Cisco feature. Contact your Cisco Account representative for detailed information on specific licensing requirements.

Call Flows

This section describes the key call flows for the 4G CUPS orchestration functionality.

VNF Onboarding

This section describes the VNF Onboarding flow.

Figure 36: VNF Onboarding

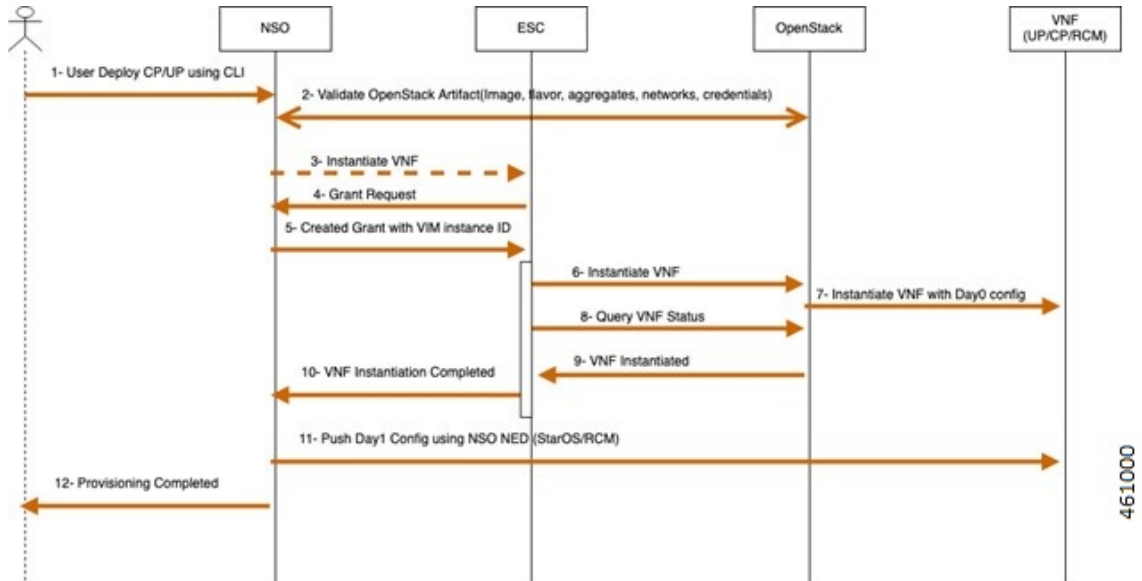

Table 45: Call Flow Description

Step	Description
1	Network operator uses NSO CLI to instantiate a VNF (CP, UP, or RCM). This includes the VIM ID to host the VNF, and the ESC.
2	NSO validates the data provided by the user via OpenStack.
3	NSO sends a SOL.003 request to instantiate the VNF on the ESC.
4	ESC sends a Grant Request to the NSO.
5	NSO sends a resource grant message to the ESC with VIM InstanceId.
6	ESC uses OpenStack API to instantiate the VNF.
7	OpenStack brings up the VNF.
8	ESC queries the OpenStack about the VNF status.
9	OpenStack replies with VNF-Up message.
10	ESC notifies the NSO about VNF instantiation.
11	NSO pushes Day-1 configuration onto the VNF.
12	NSO notifies the Operator that the VNF provisioning is complete.

P2P Module Installation

The mobility function pack supports installation of a P2P module as part of VNF deployment. The P2P module is installed after the device is onboarded. The P2P module file must be uploaded to NSO prior to the VNF deployment. The configurable parameters indicate the file location and whether P2P installation is required.

Once the P2P installation is completed, the newly instantiated VNF will bear a P2P default priority of 99 for MFP 3.4.2 and later versions. Prior to MFP 3.4.2, the P2P default priority starts with 10. To upgrade the P2P priority using the "mobility-library" action command, refer to the procedure in *Appendix C*.

VNF Termination

This section describes the VNF Termination flow.

Figure 37: VNF Termination Flow

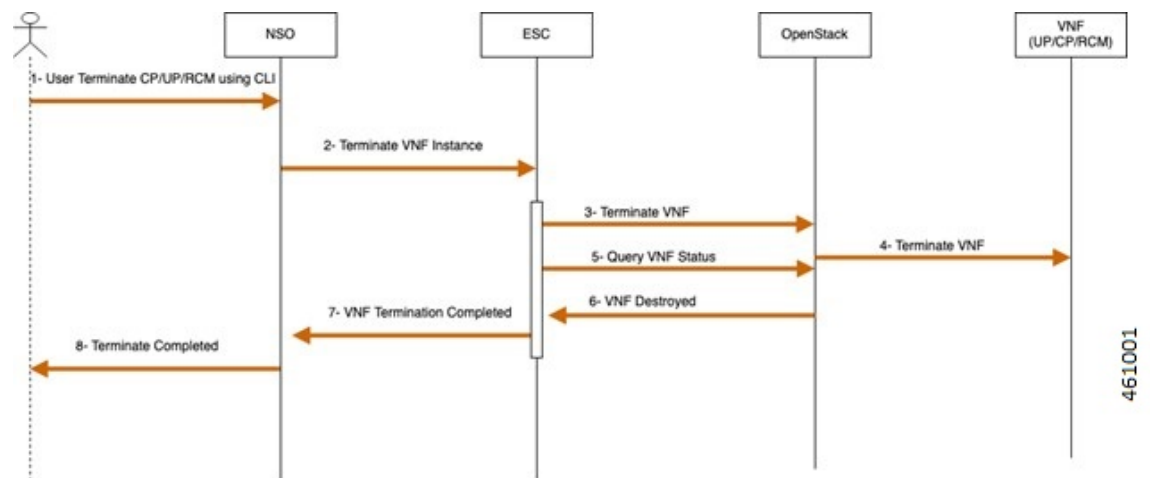

Table 46: Call Flow Description

Steps	Description
1	Operator uses NSO CLI to terminate a VNF (CP, UP, or RCM). This includes the VNF ID, VIM ID to host the VNF, and the ESC.
2	NSO sends a SOL.003 request to terminate the VNF on the ESC.
3	ESC uses OpenStack API to terminate the VNF.
4	OpenStack terminates the VNF.
5	ESC queries the OpenStack about the VNF status.
6	OpenStack replies with a VNF Destroyed message.
7	ESC notifies the NSO about VNF termination.
8	NSO notifies the Operator that the VNF termination is complete.

Recovery

Auto-healing isn't supported currently.

To recover from fault state to previous state, perform the following steps:

- Cancel or terminate the VNF instantiation. The system returns to its original state
- Cancel or recreate VNF termination process. The system returns to its original state

Limitation

The NSO Orchestration for 4G CUPS feature has the following limitation in this release:

- Production NSO instance can run only on popular Linux flavors (for example, RedHat, Cisco Linux, Ubuntu, CentOS, and so on).
- A VNF deployment may fail if the NSO/ESC instance handling the deployment goes down. This is applicable for both ESC/NSO HA as well as standalone ESC/NSO deployments. Operator intervention is required depending on the exact nature of the failure. In case of deployment followed by automated configuration push, it's possible that the deployment succeeds but the subsequent configuration push fails depending on the timing of the NSO failure.

Installing NSO Packages

The NSO Orchestration solution uses a collection of NEDs and other NSO packages. The following is a detailed list of various packages and their roles. For installation instructions of these packages, see the "Packages" chapter in the *NSO Administration Guide* for the appropriate NSO version.

1. NSO NED Packages

Most NSO NED packages are published for downloading independently. Contact your Cisco representative for details on how to download.

`ncs-6.1-rcm-nc.v21.28.mx_20240415-072244Z.tar.gz`—RCM NETCONF-based NED for RCM device communication from NSO

`ncs-6.1.6-cisco-staros-5.52.4.tar.gz`—CLI-based NED for StarOS device (SI or DI) communication from NSO

`ncs-6.1.1-etsi-sol003-1.13.18.tar.gz`—ETSI SOL003 based NED for ESC communication from NSO

`ncs-6.1-openstack-cos-4.2.30.tar.gz`—Openstack NED for Openstack communication from NSO

`ncs-6.1.2.1-cisco-etsi-nfvo-4.7.3.tar.gz`—NETCONF-based NED for ESC communication from NSO

`ncs-6.1.2.1-esc-5.10.0.97.tar.gz`—ETSI SOL-based NED for ESC communication from NSO

2. NSO Custom Packages

These are custom-built packages for Mobility VNF orchestration. NSO custom packages are bundled in the mobility function pack tar archive.

`mobility-common.tar.gz`—Common package for config and device metadata

`nfvo-common.tar.gz`—Common packages for VNF orchestration-related common utilities

nfv-device-onboarding.tar.gz—Package to support NSO device onboarding
 nfv-vim.tar.gz—Package for Openstack related precheck functionality
 nfv-vnf-lcm.tar.gz—Package for VNF Instantiation and termination logic
 mop-common.tar.gz—Common packages for config MOP-related common utilities
 mobility-mop.tar.gz—Package for Mobility MOP Config Push

3. VNF Packages Required for Orchestration (SOL003/SOL004)

These are VNF packages that are used for onboarding a specific VNF. These packages are provided only as guidelines. Mostly, a given package is customized to suit the deployment environment.

VPC-SI-2P-IMAGE-BOOT—Reference SOL003/SOL004 CSAR package for SI instantiation

RCM-IMAGE-BOOT—Reference SOL003/SOL004 CSAR package for RCM instantiation

VPC-DI-2P-1DI-ENCRYPTVOLBOOT—Reference SOL003/SOL004 CSAR package for VPC DI instantiation with two CF and four SF. SF has two service networks.

VPC-DI-2P-1DI-ENCRYPTVOLBOOT-LTD—Reference SOL003/SOL004 CSAR package for VPC DI instantiation with two CF and two SF. SF has two service networks.

VPC-DI-2P-1DI-ENCRYPTVOLBOOT-LTD-1S-NETWORK—Reference SOL003/SOL004 CSAR package for VPC DI instantiation with two CF and two SF. SF has only one service network.

create-zip.sh—Shell script to rebuild the SOL003 package, if there are any changes to SOL001 definitions or Day-0 scripts.



Note If the user is using the Mobility Function Pack already, refer to the procedure in *Appendix B: Generic Upgrade Steps of Mobility Function Pack (MFP)*.

VNF Orchestration/Deployment and Automatic Configuration Management

This solution includes the following tasks:

- Pre-population of config metadata for VNF orchestration.
- Orchestration/Deployment of VNFs (CP, UP, or RCM)
- Automatic device onboarding post VNF deployment
- Post-deployment automatic configuration push

Pre-population of Config Metadata for VNF Orchestration

Pre-population of Config Metadata is important to achieve any post-deployment configuration push from NSO in an automated mode. If there are no prepopulated data for this device, NSO instantiates the VNF and on-boards as a device in NSO.

Prepopulating of config metadata has the following structure, and population of this data is based on the network scheme and data set:

```

container
metadata-store {
  list config-metadata {
    key device-name;
    leaf device-name {
      tailf:info "onboarding device name";
      type string;
    }
    leaf redundancy_scheme {
      tailf:info "cluster-topology 1:1, N:M and N+2";
      type string;
    }
    leaf device-type {
      tailf:info "Onboarding device type vpc or rcm";
      type string;
    }
  }
  list attributes {
    key attribute-name;
    leaf attribute-name {
      tailf:info "Attribute Name";
      type string;
    }
    leaf attribute-value {
      tailf:info "Attribute Value";
      type string;
    }
  }
  list configuration-type {
    key config-type;
    tailf:info "Configuration type Day0.5, Day1 or DayN";
    leaf config-type {
      type string;
    }
  }
  list files {
    key file-name;
    tailf:info "file name";
    leaf file-name {
      type string;
    }
    leaf config-scheme {
      type string;
    }
    // CP device info
    list additional-files {
      key device;
      //cp device
      leaf device {
        tailf:info "device name";
        type string;
      }
      list additional-file {
        key additional-file-name;
        leaf additional-file-name {
          tailf:info "file name";
          type string;
        }
      }
    }
  }
}

```

```

    }
}

```

The following table provides a description of the parameters:

Parameter	Description
device-name	Name of the NSO device corresponding to the VNF. Same as VNF name.
redundancy_scheme	Type of redundancy scheme. N + 2 is standalone (no redundancy)
device-type	vpc (for SI and DI) or rcm (for RCM)
configuration-type	Day-0.5 is a special configuration for N:M redundancy. This configuration enables the UP to contact the RCM. This configuration is expected to be saved persistently.
	Day-1 is the bulk of the configuration
	Day-N generally changes to a working configuration. Does not apply to NSO Orchestration flows.
file-name	Primary configuration file(s) to be pushed
config-scheme	<p>This parameter can have one of the following values:</p> <p>Common: Configuration is pushed to all UPs regardless of role (Active or Standby).</p> <p>host-specific: This scheme is similar to “Common”, as the configuration is pushed to all UPs (Active or Standby). However, the configuration is pushed only after “common” configuration. This enables you to provide any configuration that is dependent on the “common” configuration. For example, the control-plane group configuration.</p> <p>allHostSpecific: Contains the union of host-specific configurations for all active UPs. The configuration is pushed to all the standby UPs for N:M.</p> <p>"Active1", "Active2",... "ActiveN": Host-specific configuration for the respective active UP. It is pushed only to the specific UP.</p> <p>"Active1-rcm", "Active2-rcm", .. "ActiveN-rcm": This configuration is in RCM format, and is pushed to the RCMs. RCM needs this scheme to perform configuration negation when a standby takes over for a specific active device.</p>
additional-files	This parameter pushes the related configuration to other devices (for example, pushing configuration to CP when onboarding UP). This is not yet supported.
attribute-name	This parameter identifies any attribute (variables) in the config files for dynamic substitution. Formatted as \$attribute_name
attribute-value	Value for the attribute

The following is an example of NSO action to populate or modify the config meta-data:

```

container
  config-metadata {
    // config true;
    tailf:action config-metadata-request {
      tailf:info "Invoke upgrade action on the selected devices";
      tailf:actionpoint config-metadata-request;
      input {
        list config-metadata {
          key device-name;
          leaf device-name {
            tailf:info "onboarding device name";
          }
        }
      }
    }
  }
}

```

```

        type string;
    }
    leaf device-type {
        tailf:info "Onboarding device type vpc or rcm";
        type enumeration {
            enum vpc;
            enum rcm;
        }
    }
    leaf redundancy_scheme {
        tailf:info "cluster-topology 1:1, N:M and N+2";
        type enumeration {
            enum 1:1;
            enum N:M;
            enum RCUPS;
        }
    }
}

list configuration-type {
    key config-type;
    tailf:info "Configuration type Day0.5, Day1 or DayN";
    leaf config-type {
        type enumeration {
            enum Day0.5;
            enum Day1;
            enum DayN;
        }
    }
}

list files {
    key file-name;
    tailf:info "file name";
    leaf file-name {
        type string;
    }
    leaf config-scheme {
        type enumeration {
            enum common;
            enum host-specific;
            enum host-specific-common;
        }
    }
    // CP device info
    list additional-files {
        key device;
        //cp device
        leaf device {
            tailf:info "device name";
            type string;
        }
        list additional-file {
            key additional-file-name;
            leaf additional-file-name {
                tailf:info "file name";
                type string;
            }
        }
    }
}

list attributes {

```



```
}
}
```

You can call this action using NCS CLI, as shown in the following example:

```
ubuntu@ncs> request config-metadata config-metadata-request config-metadata { device-name
staros-1 attributes { attribute-name hostname attribute-value TEST } configuration-type {
config-type Day0.5 files { file-name /home/ubuntu/tmo_action/test.txt } files { file-name
/home/ubuntu/tmo_action/day0.5.txt } } schema 1:1 }
status Success
/home/ubuntu/tmo_action/test.txt ==> syntax error: unknown command,Error: on line 3: kkk1,
/home/ubuntu/tmo_action/day0.5.txt ==> Success
[ok][2021-07-12 08:05:01]
```

NOTES:

- Config-metadata-request action has internal config validator. Config validator allows detection of syntax or certain semantic errors (for example, out of range values) in advance before pushing the configuration. Config validation requires at least a device which is onboarded in NSO (Either real-one or NetSim).

The configurable parameter is as follows:

```
container
configurable-parameters {
  leaf config-pre-validation-vpc-device-name {
    type string;
  }
  leaf config-pre-validation-rcm-device-name {
    type string;
  }
}
```

This config validation of files is also optional. If you do not want to validate the configs, you can turn-off this feature using configurable parameter. If config validation is turned off, then any error in the configuration files results in a config push error, and should be rolled back.

```
container
configurable-parameters {
  leaf config-pre-validation-required {
    type boolean;
    default false;
  }
}
```

This config metadata contains all configurable parameters.

Onboarding ESC and Openstack as Devices

For ESC installation, see ESC documentation. Prior to configuration or onboarding and instantiation of VNFs, perform the following setup steps:

NSO and ESC Environment Setup for NFV

1. SSH to ESC host using username and password

```
ssh esc@<esc-ip>
```

2. Become Sudo user

```
sudo su
```

3. Edit the following file: `vi /opt/cisco/esc/esc_database/etsi-production.properties`
4. Edit the information as shown below and save the file (Don't change anything in spring user and password). Change the NSO details accordingly. Use only local subnet management IP for communication, and not the floating-IP between ESC/NSO communication.

```
spring.security.user.name=esc
spring.security.user.password=$1$J7BUBX$Ce4vqA6JcrWCggRpYrPYg1

security.pam.service=
server.additionalConnector.port=8253
server.additionalConnector.key-alias=esc
server.esc.key-alias=esc

nfvo.apiRoot=<NSO-IP>:9191
nfvo.httpScheme=http
nfvo.userName=<NSO-User-name>
nfvo.password=<NSO-Password>
nfvo.authenticationType=BASIC

server.host=<ESC-Orch-IP>
http.enabled=true
https.enabled=false
certificate.validation=false
spring.datasource.password=${PGSQL_PASSWORD}
spring.flyway.password=${PGSQL_PASSWORD}
```

5. Restart the **escadm** service, as shown below:

escadm restart

```
Stopping esc_service: [OK]
Stopping escadm service: [OK]
Starting escadm service: [OK]
#
```

6. Check for the **escadm** health till it becomes healthy, as shown below (It may take few minutes):

escadm health

```
===== ESC =====
vimmanager (pgid 18651) is running
monitor (pgid 18688) is running
mona (pgid 18741) is running
snmp is disabled at startup
etsi (pgid 19316) is running
pgsql (pgid 18944) is running
portal (pgid 19355) is running
confd (pgid 18978) is running
escmanager (pgid 19131) is running
=====
ESC HEALTH PASSED
```

7. Login to the NSO and modify the configs according to the environment and save it into a file:

```
<config xmlns="http://tail-f.com/ns/config/1.0">
  <nfv xmlns="urn:etsi:nfv:yang:etsi-nfv-descriptors">
    <settings xmlns="http://cisco.com/ns/nso/cfp/cisco-etsi-nfvo">
      <image-server>
        <ip-address><NSO-IP></ip-address>
        <port>8010</port>
        <document-root>/var/opt/ncs/vnfpackages</document-root>
      </image-server>
    <etsi-sol3>
      <server>
```

```

<ip-address><NSO-IP></ip-address>
<port>9191</port>
<use-ssl>false</use-ssl>
<document-root>/var/opt/ncs</document-root>
<auth-enabled>true</auth-enabled>
<auth-types>
  <basic>
    <username><NSO-USERNAME></username>
    <password><NSO-PASSWORD></password>
  </basic>
</auth-types>
</server>
<vnfm-behaviour>
  <vnfm-behaviour-override>
    <id>default-sol3</id>
    <rpc-behaviour>
      <rpc>
        <include>
          <vim-info>false</vim-info>
        </include>
      </rpc>
      <modify>
        <pre>
          <rpc>false</rpc>
        </pre>
        <post>
          <rpc>true</rpc>
        </post>
      </modify>
    </rpc-behaviour>
  </grant>
  <store-history>false</store-history>
  <heal>
    <authorise-grant>true</authorise-grant>
  </heal>
</grant>
<onboarding>
  <store-details>true</store-details>
</onboarding>
</vnfm-behaviour-override>
</vnfm-behaviour>
</etsi-sol3>
</settings>
</nfv>
</config>

```

8. Compile all the packages in package folder and perform package reload.

```

ubuntu@test-nso:/var/opt/ncs/packages$ ncs_cli -C
User ubuntu last logged in 2021-09-23T08:00:34.649202+00:00, to test-nso, from
209.165.200.225 using cli-ssh
ubuntu connected from 209.165.200.225 using ssh on test-nso
ubuntu@ncs# packages reload

```

9. Load merge the file, as shown below. This step enables NSO as NFVO and runs NFVO service in 9191 port:

```

ubuntu@test-nso:~$ vi config.xml
ubuntu@test-nso:~$ ncs_cli -C

User ubuntu last logged in 2021-08-04T09:10:55.819283+00:00, to test-nso, from
209.165.200.226 using cli-ssh
ubuntu connected from 209.165.200.227 using ssh on test-nso
ubuntu@ncs# config

```



```

Entering configuration mode terminal
ubuntu@ncs(config)# load merge config.xml
Loading.
1.54 KiB parsed in 0.01 sec (128.38 KiB/sec)
ubuntu@ncs(config)# commit

```

10. Update NACM rule by adding NSO username to “ncsadmin” group

```

ubuntu@test-nso:~$ ncs_cli -C

User ubuntu last logged in 2021-08-06T09:56:26.370979+00:00, to test-nso, from
209.165.200.227 using cli-ssh
ubuntu connected from 209.165.200.227 using ssh on test-nso
ubuntu@ncs# config
Entering configuration mode terminal
ubuntu@ncs(config)# nacm groups group ncsadmin user-name ubuntu
ubuntu@ncs(config-group-ncsadmin)# commit

```

11. Copy the necessary packages to the standard location on the NSO (typically /var/opt/ncs/packages).

12. Perform package reload and check for package status. Status should be UP for all packages.

```

ubuntu@test-nso:~$ ncs_cli -C

User ubuntu last logged in 2021-08-06T09:58:39.866838+00:00, to test-nso, from
209.165.200.227 using cli-ssh
ubuntu connected from 209.165.200.227 using ssh on test-nso
ubuntu@ncs# packages reload
ubuntu@ncs# show packages package oper-status

```

NAME	UP	PROGRAM	CODE	ERROR	JAVA	UNINITIALIZED	PYTHON	UNINITIALIZED
cisco-etsi-nfvo	X	-			-		-	
cisco-rcm-nc-1.0	X	-			-		-	
cisco-staros-cli-5.38	X	-			-		-	
esc	X	-			-		-	
etsi-sol003-gen-1.13	X	-			-		-	
mobility-common	X	-			-		-	
mop-automation	X	-			-		-	
mop-common	X	-			-		-	
nfv-common	X	-			-		-	
nfv-device-onboarding	X	-			-		-	
nfv-vim	X	-			-		-	
nfv-vnf-lcm	X	-			-		-	
openstack-cos-gen-4.2	X	-			-		-	

13. Setup the notification stream: Update /etc/ncs/ncs.conf file to add "nfv-events" stream.

```

<ncs-config>
  <event-streams>
    <notifications>
      <stream>
        <name>nfv-events</name>
        <description>Generic netconf notification stream for NFV events</description>

        <replay-support>true</replay-support>
        <builtin-replay-store>
          <enabled>true</enabled>
          <dir>${NCS_RUN_DIR}/state</dir>
          <max-size>S10M</max-size>
          <max-files>50</max-files>
        </builtin-replay-store>
      </stream>

```

```

    </event-streams>
  </notifications>
</ncs-config>

```

14. Restart NSO as sudo user.

```

/etc/init.d/ncs stop
Stopping ncs (via systemctl): [ OK ]
/etc/init.d/ncs start
Starting ncs (via systemctl): [ OK ]

```

15. Onboard NETCONF, ESC, ETSI SOL003 ESC, and Openstack as devices in NSO via device onboarding APIs.

- a. Onboard Openstack as a device. The following is an example. Customize to the specific deployment. This can be configured via NSO CLI in the configuration mode. See NSO documentation for information about authgroup.

```

devices device openstack
address 209.165.200.228
port 5000
authgroup openstack
device-type generic ned-id openstack-cos-gen-4.2

```

- b. Onboard ESC ETSI interface as a device. The following is an example. Customize to the specific deployment.

```

devices device esc-etsi
address 209.165.200.229
port 8250
authgroup esc-etsi
device-type generic ned-id etsi-sol003-gen-1.13

```

- c. Onboard ESC native NETCONF interface as a device. The following is an example. Customize to the specific deployment.

```

devices device esc-netconf
address 209.165.200.229
ssh host-key ssh-rsa
key-data "AAAAB3NzaC1yc2EAAAADAQABAAQDYwNCaa3ghJtnJSvn/
aSPjCuoMKmssZds+J5d9JcOS\n3h3V/fCtJwiH7qMgMXnNc0LEr1fZhxQ4kg5o/
IafmoYD7N+w/ECqWEP68sjeN+AftiZ9J74D\n+/KDonffgBCHxIVEo0XHYlojrtmpg/
EH9/N3fQgoSzEhGItGG4uMaAzBwRlpO8AApOP1Pi4r\nciL4Qemi6u4i/
HGFr8MqQp5qcMFd8O300lB1q1vKn9sq/9sL6EzqyUd2lMounDg1EQYMgi8J\
nyG6upsOFuvhiYRC9qfHML45quyepsJdVi2Li2QwUJLa89EDh148RlhLTJs4s2iAwBGNdvLdK\ntzLu2VGyWKqH"
!
authgroup esc-netconf
device-type netconf ned-id esc

```

16. Track the device addition status as shown below (for different devices):

```
ubuntu@test-nso:~$ ncs_cli -C
```

```
User ubuntu last logged in 2021-08-06T10:09:23.550686+00:00, to test-nso, from
209.165.200.227 using cli-ssh
```

```
ubuntu connected from 209.165.200.227 using ssh on test-nso
```

```
ubuntu@ncs# show vnf-status instances esc-netconf
```

```

INSTANCE ID  TIMESTAMP  FUNCTION TYPE OPERATION  STATUS  STATUS MESSAGE
-----
esc-netconf  2021-07-21 *    -          init    success  Device Onboarding initialized
                2021-07-21 *    -          init    success  Device Onboarding initialized

```

```

2021-07-21 * - fetch-ssh-keys success fetch-ssh-keys was successful
2021-07-21 * - connect success connect was successful
2021-07-21 * - sync-from success sync-from was successful
2021-07-21 * - device-config success Subscribed to ESC Netconf
notification escEvent Stream
2021-07-21 * - ready success Device Successfully onboarded

```

Prerequisites for VNF Instantiation

Before submitting the VNF deployment request, make the following configuration changes:

1. Configurable parameters

Set the following configurable parameters, if required:

- configurable-parameters device-ping-sleeptimesec 30 (default value is 30 sec)
- configurable-parameters device-ping-retries 150 (default value is 30. In case of RCM, configure it to some higher value, for example, 150)
- configurable-parameters p2p-required true (default value is false)
- configurable-parameters p2p-soFile-path /var/opt/ncs/patch_libp2p-2.64.1418.so.tgz

2. Prepopulating of config metadata

When you configure Config-metadata, the device name must be the same as VNF instance name.

You can call this action from RESTCONF, as shown in the following example:

URI:

http://<NSO-IP>:<NSO-REST-PORT>/restconf/data/mobility-common:config-metadata/config-metadata-request

Method: POST

Content-Type: application/yang-data+json

Sample Payload:

```

{
  "config-metadata": {
    "device-name": "test2",
    "schema" : "1:1",
    "attributes":{
      "attribute-name":"test",
      "attribute-value": "gh"
    },
    "configuration-type":{
      "config-type": "Day1",
      "files":{
        "file-name":"/home/ubuntu/tmo_action/test.txt"
      },
      "files":{
        "file-name":"/home/ubuntu/tmo_action/day0.5.txt"
      }
    }
  }
}

```

```

    }
}

```

Ensure to follow the criteria described in the following figure while pre-populating config metadata:

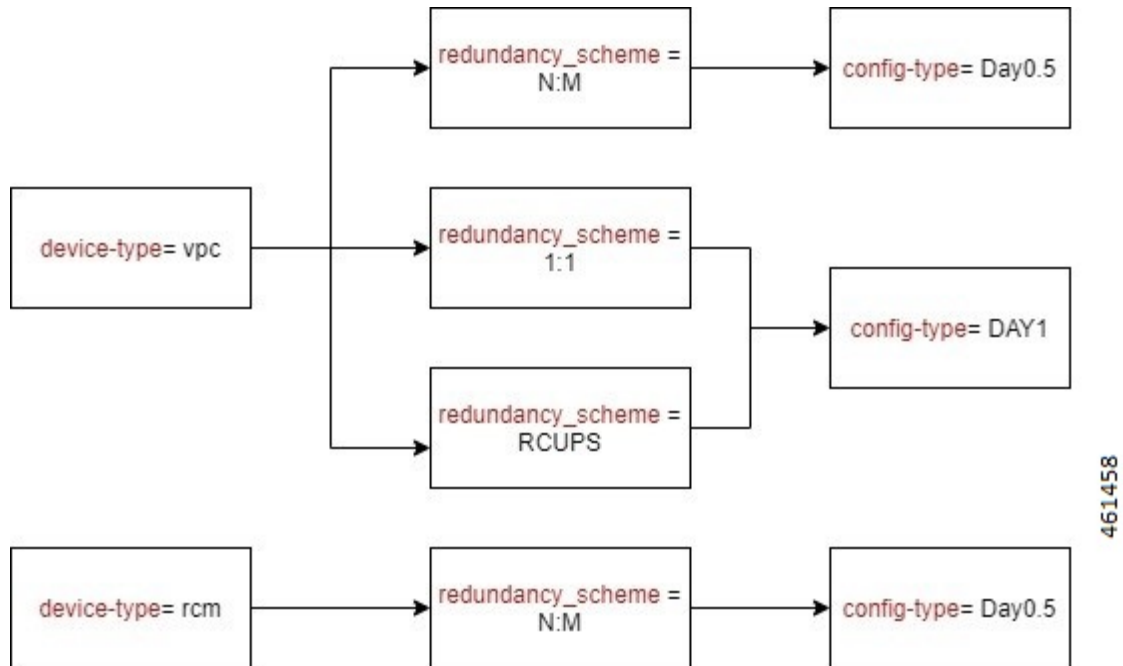

VNF Instantiation

VNF is instantiated upon configuration. So, to instantiate the VNF, you must load the VNF configuration into the NSO. The VNF has references to the SOL006 VNFD. It also has references to VIM artifacts like Openstack tenant networks, and IP addresses. For details about YANG definition of VNF, see [Appendix A: YANG definition of VNF](#).

Instantiating a VNF involves many components:

- An ETSI SOL001 VNFD template packaged as a TOSCA VNF package
- An ETSI SOL006 VNFD with the same name or ID as the VNF package
- A VNF instance that is proprietary to the NSO

The Mobility function pack ships with some example VNF packages, which also contain the corresponding SOL006 VNFD. These examples can be used as a base, but additional customization is required to fit the deployment. An example VNF configuration is given below:

```

{
  "nfv-vnf-lcm:nfv-vnf": [
    {
      "network-function-type": "VPC-SI",
      "name": "test026",
      "vnfd": "VPC-SI-2P-IMAGE-BOOT",
      "instantiation-level": "default",
      "deployment-flavor": "default",
    }
  ]
}

```

```

"mgmt-user-name": "admin",
"mgmt-password": "Cscoc@123",
"host-name": "vpc-si",
"domain-name": "cisco.com",
"ntp-server": "209.165.201.1",
"name-server": "209.165.201.2",
"location": {
  "vim": {
    "name": "openstack",
    "project": "test",
    "zone-id": "nova"
  },
  "vnfm": "esc-etsi"
},
"network": [
  {
    "type": "VIM_NETWORK_MANAGEMENT",
    "extent": "external",
    "name": "test-mgmt",
    "subnet-name": "test-mgmt-subnet"
  },
  {
    "type": "VIM_NETWORK_ORCHESTRATION",
    "extent": "external",
    "name": "test-orch",
    "subnet-name": "test-orch-subnet"
  },
  {
    "type": "VIM_NETWORK_SERVICE_1",
    "extent": "external",
    "name": "service1",
    "subnet-name": "service1"
  },
  {
    "type": "VIM_NETWORK_SERVICE_2",
    "extent": "external",
    "name": "service2",
    "subnet-name": "service2"
  }
],
"unit": [
  {
    "type": "VPC-SI",
    "image": "core-si-21.23",
    "flavor": "core-si",
    "connection-point": [
      {
        "name": "nic0",
        "ip-address": [
          {
            "id": 0,
            "fixed-address": [
              "209.165.201.3"
            ]
          }
        ]
      },
      {
        "name": "nic1",
        "ip-address": [

```

```

        {
            "id":0,
            "fixed-address":[
                "209.165.201.4"
            ]
        }
    ],
    "security-group":[
        "default"
    ],
    "network-type":"VIM_NETWORK_MANAGEMENT"
},
{
    "name":"nic2",
    "ip-address":[
        {
            "id":0,
            "fixed-address":[
                "209.165.201.5"
            ]
        }
    ],
    "security-group":[
        "default"
    ],
    "network-type":"VIM_NETWORK_SERVICE_1"
},
{
    "name":"nic3",
    "ip-address":[
        {
            "id":0,
            "fixed-address":[
                "209.165.201.6"
            ]
        }
    ],
    "security-group":[
        "default"
    ],
    "network-type":"VIM_NETWORK_SERVICE_2"
}
]
},
"extra-parameters":[
    {
        "name":"BOOTUP_TIME",
        "value":"100"
    },
    {
        "name":"LICENSE_KEY",
        "value":"\"VER=1|DOI=1624646484|DOE=1640457684|ISS=3|NUM=212017|
CMT=SWIFT_License|LSG=5000000|LEC=10000000|LGT=5000000|FIS=Y|FR4=Y|FTC=Y|FSR=Y|
FPM=Y|FID=Y|FI6=Y|FLI=Y|FFA=Y|FCA=Y|FTP=Y|FTA=Y|FDR=Y|FDC=Y|FGR=Y|FAA=Y|FDQ=Y|
FEL=Y|BEP=Y|FAI=Y|FCP=Y|LCF=5000000|LPP=5000000|LSF=5000000|FLS=Y|FSG=Y|
LGW=5000000|HIL=XT2|LSB=5000000|LMM=5000000|FIB=Y|FND=Y|FAP=Y|FRE=Y|FHE=Y|
FUO=Y|FUR=Y|FOP=Y|FRB=Y|FCF=Y|FVO=Y|FST=Y|FSI=Y|FRV=Y|F6D=Y|F13=Y|FIM=Y|
FLP=Y|FSE=Y|FMF=Y|FEE=Y|FHH=Y|FIT=Y|FSB=Y|FDS=Y|LSE=5000000|FLR=Y|FLG=Y|
FMC=Y|FOC=Y|FOS=Y|FIR=Y|FNE=Y|FGD=Y|LIP=5000000|FOE=Y|FAU=Y|FEG=Y|FL2=Y|
FSH=Y|FLF=Y|FSP=Y|FNI=Y|FCI=Y|FME=Y|FCN=Y|FUB=Y|FSP=Y|FGO=Y|FPE=Y|FWI=Y|
FAC=Y|FIE=Y|FSM=Y|FAG=Y|FNQ=Y|FEW=Y|FAR=Y|FOX=Y|FPW=Y|FAM=Y|FGX=Y|FWT=Y|
FUA=Y|LDT=5000000|LEX=5000000|LVL=5000000|LQP=5000000|LMP=5000000|
LCU=10000000|LUU=10000000|FXS=Y|FLC=Y|FRT=Y|FSX=Y|FBS=Y|FRD=Y|FXM=Y|

```

```
LTO=10000000|FNS=Y|LNS=5000000|SIG=MCOCFBge/
OTZha2Ta7c1L5CLOL2tgDIDAhUAhIKwZxXEJpr9Xk5buNyzZStrNM\"
    }
  ]
}
]
}
```

The following is another example to instantiate RCM VNF:

```
{
  "nfv-vnf-lcm:nfv-vnf": [
    {
      "network-function-type": "RCM",
      "name": "RCM-ahhashem-sol003-78",
      "vnfd": "RCM-IMAGE-BOOT",
      "instantiation-level": "default",
      "deployment-flavor": "default",
      "mgmt-user-name": "luser",
      "mgmt-password": "$8$40/jVMTHJY+Jrd7mZiwqdrKEIz6Kc5Pt2Qvnwi0/65g=";
      "host-name": "rcm",
      "domain-name": "cisco.com",
      "ntp-server": "209.165.201.1",
      "name-server": "209.165.201.1",
      "location": {
        "vim": {
          "name": "openstack",
          "project": "ahhashem",
          "zone-id": "nova"
        },
        "vnfm": "esc-etsi"
      },
    },
    "network": [
      {
        "type": "VIM_NETWORK_MANAGEMENT",
        "name": "ahhashem-mgmt",
        "extent": "external",
        "subnet-name": "ahhashem-mgmt-subnet"
      },
      {
        "type": "VIM_NETWORK_ORCHESTRATION",
        "name": "ahhashem-orch",
        "extent": "external",
        "subnet-name": "ahhashem-orch-subnet"
      },
      {
        "type": "VIM_NETWORK_SERVICE_1",
        "name": "service1",
        "extent": "external",
        "subnet-name": "service1"
      },
      {
        "type": "VIM_NETWORK_SERVICE_2",
        "name": "service2",
        "extent": "external",
        "subnet-name": "service2"
      }
    ],
    "unit": [
      {
        "type": "RCM",
        "image": "core-rcm-21.23",
        "flavor": "mkal-rcm-hugepages",
        "connection-point": [
          {
```

```

        "name": "nic0",
        "ip-address": {
            "id": 1,
            "fixed-address": ["209.165.201.7"]
        },
        "security-group": ["default"],
        "network-type": "VIM_NETWORK_ORCHESTRATION"
    },
    {
        "name": "nic1",
        "ip-address": {
            "id": 1,
            "fixed-address": ["209.165.201.8"]
        },
        "security-group": ["default"],
        "network-type": "VIM_NETWORK_MANAGEMENT"
    },
    {
        "name": "nic2",
        "ip-address": {
            "id": 1,
            "fixed-address": ["209.165.201.9"]
        },
        "security-group": ["default"],
        "network-type": "VIM_NETWORK_SERVICE_1"
    },
    {
        "name": "nic3",
        "ip-address": {
            "id": 1,
            "fixed-address": ["209.165.201.10"]
        },
        "security-group": ["default"],
        "network-type": "VIM_NETWORK_SERVICE_2"
    }
]
},
"extra-parameters": [
    {
        "name": "VIM_VM_NAME",
        "value": "RCM-ahhashem-sol003-78"
    },
    {
        "name": "HOST_NAME",
        "value": "rcm"
    },
    {
        "name": "NIC0_TYPE",
        "value": "virtual"
    },
    {
        "name": "NIC1_TYPE",
        "value": "virtual"
    },
    {
        "name": "NIC2_TYPE",
        "value": "direct"
    },
    {
        "name": "NIC3_TYPE",
        "value": "direct"
    }
],

```



```

    {
      "name": "MGMT_USER_NAME",
      "value": "luser"
    },
    {
      "name": "MGMT_PASSWORD_ROUND4096",
      "value": "$6$rounds=4096$P2wdTbEBO0LHmHi$OwbVEIarMbt
Qxbu5Us5kW0n0MOWp3QN9eVRX7WjvLm4xTJvFp16vHez3XkKm39XJJ7dGRRIsZqXfcZRjQBA7E."
    },
    {
      "name": "SERVICE_INTERFACE_IP_1",
      "value": "209.165.201.9"
    },
    {
      "name": "SERVICE_INTERFACE_IP_2",
      "value": "209.165.201.11"
    },
    {
      "name": "NTP_SERVER",
      "value": ["209.165.201.12", "209.165.201.13", "209.165.201.14"]
    }
  ]
}
]
}

```

VNF Instantiation - Component Interactions and Flows

The following figure illustrates the complete flow of end-to-end instantiation automation:

Figure 38: VNF Instantiation Interactions

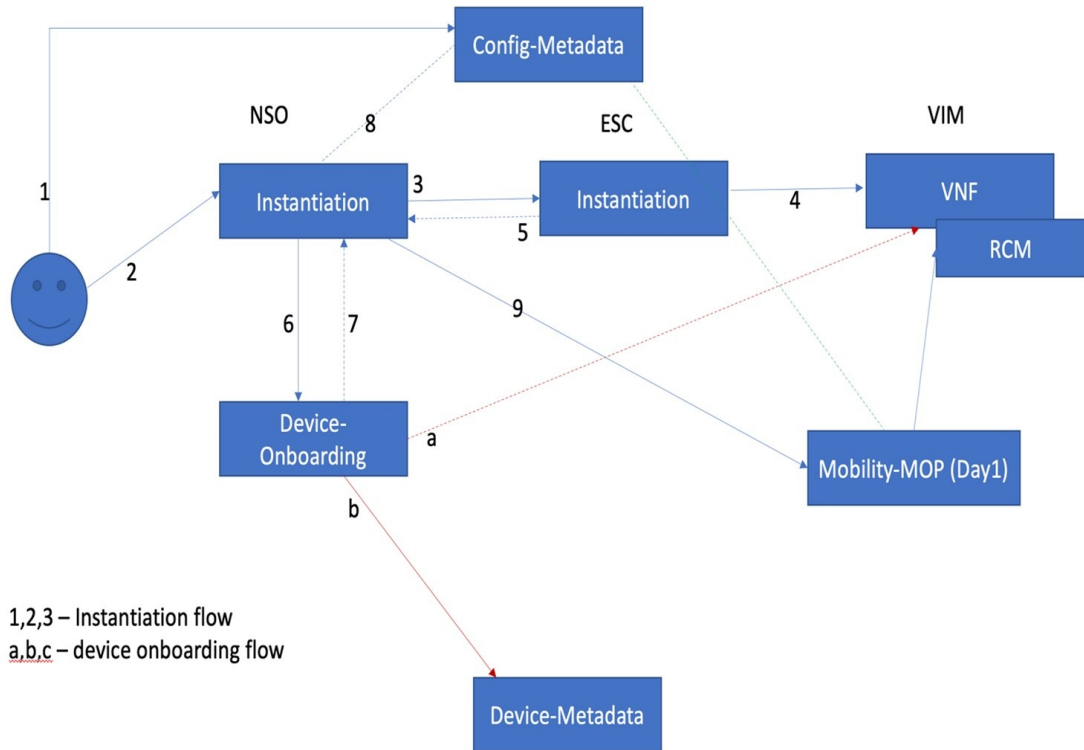
**Detailed Steps:**

1. The Network operator has all the required details for VNF instantiation including the name, type, dynamic attributes, and the configuration files. The network operator places the config files into the NSO filesystem, and registers the details with NSO config DB for automation.

This step includes the following tasks:

- The network operator Secure copy (SCP) the config files into NSO filesystem. This location must be an NFS, or it's replicated in NSO HA environment.
- Registers all attribute value pairs, dynamic substitution values, Day-0.5, or Day-1 configurations.
- Enables the validation of config files, and provides the testing device details.
- If the revalidation flag is set to true, config metadata action internally validates all config files. Otherwise, it fails while applying the configuration.

2. The Network operator prepares the payload for VNF instantiation with all the details. Then, the network operator invokes the payload to create an instance. It does the basic validation and processes the order.

This step includes the following task:

- Validates the inputs such as password length, image, flavor, and network existence in Openstack before invoking an order

3. NSO processes the order internally and prepares the ESC VNF instantiation order.

This step includes the following tasks:

- Creates NSO footprint of the service
- Does CSAR validation
- Invokes ESC VNF instantiation order using SOL3/SOL4 input
- Starts listening to ESC notifications (both ETSI and NETCONF)

4. ESC performs input validation of SOL3/SOL4 and creates the order in VIM.

This step includes the following tasks:

- ESC invokes VNF instantiation.
- On Successful invocation of VNF, it creates mono monitors to monitor the VNF.
- Returns the updates via ETSI and NETCONF notifications to NSO (both Success and Failure).

5. ESC returns the periodic updates on progress to NSO via ETSI or NETCONF notifications.

This step includes the following tasks:

- ESC constantly sends the ETSI and NETCONF notifications on progress.
- ETSI notification comprises deploy – init, processing, and completed notification.
- NETCONF notifications provide more granular information on VM status.
- On Failure, it gives appropriate error message.

6. On receiving VNF instantiation completion message from ESC, NSO onboards as an NSO device.

This step includes the following tasks:

- Instantiation logic fetches the details from input payload, and invokes device onboarding logic.
- NSO performs the fetch-ssh-host-key from the device.
- NSO performs connection check.
- NSO performs sync-from.
- NSO executes post check command such as “show version” on device.
- NSO adds the device into NSO device tree.

7. NSO instantiation logic waits for device addition to complete.

This step includes the following tasks:

- NSO checks if device onboarding process is complete.
- If device onboarding fails, NSO stops the execution.

8. NSO instantiation logic reads the prepopulated config metadata to interpret the config to be pushed.

This step includes the following tasks:

- Reads the prepopulated config metadata and interprets the Day-0.5 or Day-1 configuration files based on the device-name (Device name is based on VNF name)
 - For RCM-based N:M scheme, Day-0.5 is pushed.
 - On 1:1 case, Day-1 is pushed.
 - On missing information, instantiation completes and stops processing.
9. NSO takes the config files from config metadata, formulates the Mobility MOP input format, and invokes the MOP for config push.

This step includes the following tasks:

- Invokes the Mobility MOP and gets the task-id.
- Periodically checks for the status on task-id.
- Saves the config permanently in device flash if its 1:1 CP or UP pairs (via MOP).
- Completion status is updated in vnf-status ledger.

Checking the VNF Instantiation Status

You can check the status of VNF instantiation using **vnf-status** command periodically.

Any failure, processing, or completion related messages are appended in the status message.

```
show vnf-status instances vnf-instance-name
INSTANCE ID  TIMESTAMP  TYPE  OPERATION  STATUS  STATUS  MESSAGE
-----
<VNF-Name> <Time-Stamp> <type> <function> <status> <message-if-any>
```

VNF Dashboard

VNF instantiation steps and current status of the VNF are displayed in NSO based dashboard.

VNF Deletion

The following flow diagram illustrates the complete flow of end-to-end deletion automation.

Figure 39: VNF Deletion Interactions

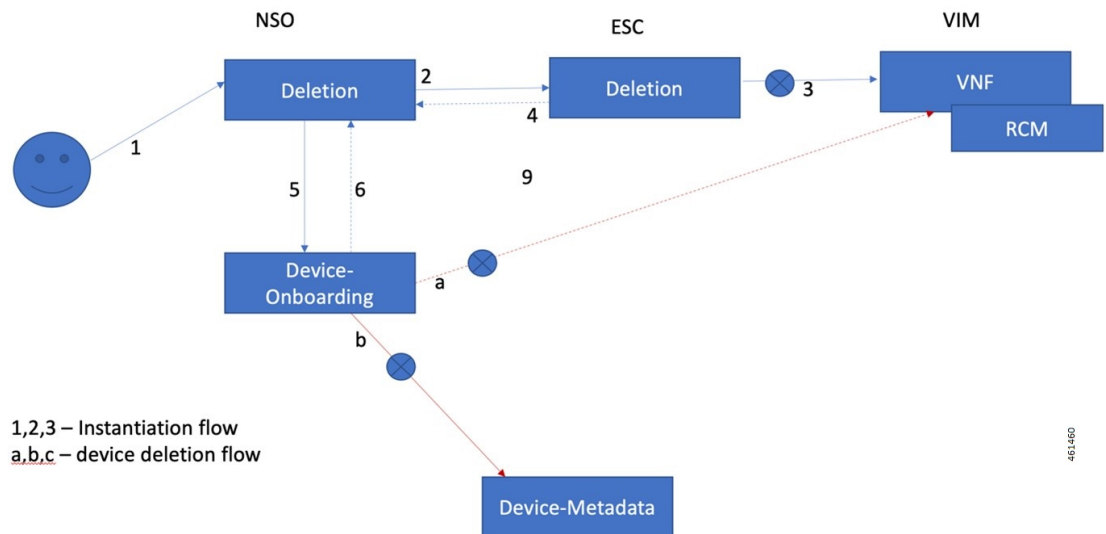
**Detailed Steps:**

1. Network operator decides to decommission or delete the existing instance, which is in running or failed state.

This step includes the following tasks:

- Network operator provides the VNF-name with type for the deletion
- NSO does the validation of the VNF existence

2. NSO checks for the VNF instance status, and if there is a failed instance at NSO end, NSO invokes ESC for deletion from VIM or perform rollback.

This step includes the following tasks:

- NSO decides to push it to ESC or perform rollback (in case of failed instance within NSO)
- NSO does the asynchronous request to ESC and waits for notifications.

3. ESC does the clean-up and removes the VNF monitors.

4. ESC generates ETSI/NETCONF notifications to NSO.

5. NSO processes ESC notifications and performs the following:

- Invokes the device-onboarding package for deletion of the instance
- Removes entry from “nfv-vnf-inventory”

6. Device onboarding package deletes the device from NSO, and the status is updated in the VNF ledger.

Checking the VNF Deletion Status

You can check the status of VNF deletion using **vnf-status** command.

Any failure, processing, or completion related messages are appended in the status message

```
show vnf-status instances vnf-instance-name
INSTANCE ID  TIMESTAMP  TYPE  OPERATION  STATUS  STATUS  MESSAGE
-----
<VNF-Name> <Time-Stamp> <type> <function> <status> <message-if-any>
```

Removing Configuration Metadata

This is a manual step, and you need to remove the config metadata using NSO action. Keeping this data doesn't have any impact.

Cleaning Config Files from NSO Filesystem

You need to remove the config files manually from NSO filesystem. Keeping this data doesn't have any impact.

Automation Process - VNF Deployment, Onboarding, and Configuration Push

The Automation process includes the following sections:

Instantiation of VNF using Input Payload

After making necessary changes, submit the instantiation request using input payload. The automation process for VNF instantiation starts.

For input payload sample, see the section [VNF Instantiation](#).

Onboarding VNF as a Device in NSO

Upon successful instantiation, the VNF is onboarded as a device on the NSO. The device name is the same as the VNF name.

Installing the P2P Module in VPC Device

If the "device-type" is of VPC type and the configurable-parameters "p2p-required" is set to "true" with the "p2p-soFile-path" defined, copy the P2P file to device flash directory, and then upgrade the P2P module.

The P2P module is installed on the device.

Configuration Push to the Onboarded Device

The following are the static parameters that are used during automated config push:

- operation-type =Commit
- mop-type=Common
- save-config-permanently= default is false, and it is set to true when the device type is "vpc"

Once the config push is done using the configuration files, a task-id is generated. Using the task-id, it checks the status of config-push, and based on the status, the ledger entry is updated.



Note NSO doesn't perform configuration audit on RCM. If an RCM reboots when NSO is in the process of pushing configuration to it, the NSO doesn't re-push the configuration upon reboot completion. The configuration must be re-pushed manually. NSO alerts the operator about configuration push failure. Any configuration successfully pushed to the RCM is persistent across reboots of that RCM.

Appendix A: YANG definition of VNF

This section provides a sample YANG definition of VNF.

```

module nfv-vnf-lcm {
  namespace "http://com/cisco/cx/servicepack/nfv/vnflcm";
  prefix nfv-vnf-lcm;

  import ietf-inet-types { prefix inet; }
  import tailf-common { prefix tailf; }
  import tailf-ncs { prefix ncs; }
  import nfv-common { prefix nfv-common; }
  import tailf-kicker { prefix kicker; }
  include nfv-vnf-lcm-nano {
    revision-date 2020-02-14;
  }

  organization "Cisco-AS";

  contact "Cisco AS";

  description "Generic NFV VNF LCM service package";

  revision 2020-10-22 {
    description "Active Inventory and LCM Auto/on-demand heal support";
  }

  revision 2020-07-01 {
    description "Re-branded per new naming convention";
  }

  revision 2020-02-14 {
    description "First version, ready for testing";
  }

  notification vnf-lcm {
    description "Notification about Network Function Operation";
    uses nfv-common:network-function-notification;
  }

  notification vnf-alarm {
    description "VNF alarms";
    uses nfv-common:vnf-alarm;
  }

  container nfv-vnf-inventory {
    tailf:info "CDB model to persist the VNFs, associated project, VIM and the
      VM details";
    config false;
    tailf:cdb-oper {
      tailf:persistent true;
    }
  }
}

```

```

list vnf {
  tailf:info "VNFs with associated VMs and status";
  key name;
  leaf name {
    tailf:info "VNF Name";
    type string;
  }
  leaf vnfd {
    type string;
    tailf:info "Associated VNFD name";
  }
  leaf project {
    type string;
    tailf:info "Associated vim tenant/project";
  }
  leaf vim {
    type string;
    tailf:info "Associated VIM";
  }
  leaf status {
    type string;
    tailf:info "Overall VNF status";
  }
}
list vm {
  tailf:info "Associated VMs and the status";
  key name;
  leaf name {
    type string;
    tailf:info "VM name";
  }
  leaf type {
    type string;
    tailf:info "VM Type";
  }
  leaf flavor {
    type string;
    tailf:info "VIM flavor that is used to deploy the VM";
  }
  leaf host {
    type string;
    tailf:info "Compute host where the VM has been deployed";
  }
  list connection-point {
    key nic-id;
    leaf nic-id {
      type uint8;
      tailf:info "NIC id of the connection point";
    }
    leaf ip-address {
      type inet:ip-address;
      tailf:info "IP address of the connection point";
    }
  }
  leaf status {
    type string;
    tailf:info "VM status";
  }
}

leaf netconf-notification-done {
  tailf:hidden nfv-internal;
  type empty;
}

```



```

    }
  }

  list nfv-vnf {
    description "Generic RFS model for VNF LCM";

    key "network-function-type name";

    leaf network-function-type {
      tailf:info "virtual network function type";
      type enumeration {
        enum "VPC-SI";
        enum "VPC-DI";
        enum "CSRLKV";
        enum "GENERIC";
        enum "VCU";
        enum "VDU";
        enum "EMS";
        enum "RCM";
      }
    }

    leaf name {
      tailf:info "Unique service id";
      type string;
    }

    leaf vnfd {
      mandatory true;
      type string;
      tailf:info "VNFD to use for this type of Network Function that has to be
        onboarded on the target VIM.";
    }

    uses ncs:service-data;
    ncs:servicepoint nfv-vnf-lcm;
    uses ncs:nano-plan-data;

    tailf:action heal {
      tailf:info "Heal VNF";
      tailf:actionpoint nfv-lcm-heal-ap;
      input {
      }
      output {
        uses nfv-common:standard-action-response;
      }
    }

    tailf:action start {
      tailf:info "Start VNF";
      tailf:actionpoint nfv-lcm-start-ap;
      input {
      }
      output {
        uses nfv-common:standard-action-response;
      }
    }

    tailf:action stop {
      tailf:info "Stop VNF";
      tailf:actionpoint nfv-lcm-stop-ap;
      input {
      }
      output {

```

```

        uses nfv-common:standard-action-response;
    }
}

tailf:action scale {
    tailf:info "Scale-In VNF";
    tailf:actionpoint nfv-lcm-scale-ap;
    input {
        leaf scale-type {
            mandatory true;
            tailf:info "SCALE IN or OUT";
            type enumeration {
                enum "OUT";
                enum "IN";
            }
        }

        leaf no-of-instances {
            tailf:info "Number of scale IN or OUT instances. Default is 1";
            type uint32;
            default 1;
        }

        leaf vdu-type {
            mandatory true;
            tailf:info "vdu-type as CF/SF/VPC-SI etc";
            type string;
        }
    }
    output {
        uses nfv-common:standard-action-response;
    }
}

tailf:action retry {
    tailf:info "Stop VNF";
    tailf:actionpoint nfv-lcm-retry-ap;
    input {
    }
    output {
        uses nfv-common:standard-action-response;
    }
}

leaf instantiation-level {
    type string;
    default "default";
    tailf:info "Instantiation level defined in VNFD to use. This will determine
        the number of VMs/VDUs to be deployed.";
}

leaf deployment-flavor {
    type string;
    default "default";
    tailf:info "Deployment flavor defined in the VNFD to use. Describes a specific
        deployment version of a VNF with specific requirements for capacity
        and performance.";
}

leaf mgmt-user-name {
    type nfv-common:identifier;
    description " Management login username specific to this VNF. Default values
        can be configured per VNF type.";
}

```

```

leaf mgmt-password {
  tailf:suppress-echo "true";
  type tailf:aes-cfb-128-encrypted-string;
  description "Management login password specific to this VNF.";
}

leaf host-name {
  type inet:domain-name;
  description "Hostname to use to communicate with this network function";
}

leaf domain-name {
  type inet:domain-name;
  description "Domain name used to construct Fully Qualified Domain Name by
    concatenating with VM hostname: <hostname>.<domain>";
}

leaf ntp-server {
  description "NTP server to use for VNFs deployed in this data center";
  type inet:host;
}

leaf name-server {
  type inet:ip-address;
  description "Name server";
}

container location {
  container vim {
    leaf name {
      description "NFVI this Network Function is deployed on.";
      type leafref {
        path "/ncs:devices/ncs:device/ncs:name";
      }
      //must "/ncs:devices/ncs:device[ncs:name=current()]/ncs:platform/ncs:name
      //      = 'Openstack'" {
      //  error-message "Please select Openstack devices only";
      //}
    }
    leaf project {
      type nfv-common:identifier;
      description "VIM project used to instantiate VNFs";
      mandatory true;
    }
    leaf zone-id {
      type string;
      default "nova";
      description "VIM zone id";
    }
    //TODO might need to support user domain and project domain
  }
  leaf vnf {
    mandatory true;
    type leafref {
      path "/ncs:devices/ncs:device/ncs:name";
    }
    //must "/ncs:devices/ncs:device[ncs:name=current()]/ncs:platform/ncs:name
    //      = 'ETSI SOL'" {
    //  error-message "Please select ETSI-SOL VNF devices only";
    //}
    description "ESC VNF onboarded";
  }
}

```

```

list network {
  key type;
  leaf type {
    type nfv-common:identifier;
  }
  leaf name {
    type nfv-common:identifier;
    mandatory true;
  }
  leaf extent {
    type nfv-common:network-extent;
  }
  leaf subnet-name {
    when "../extent='external'";
    type nfv-common:identifier;
    mandatory true;
  }
}

list unit {
  description "Virtual Deployment Unit, a single VM.";
  key type;

  leaf type {
    description "VDU type as defined in the VNFD of this Network Function.";
    type nfv-common:identifier;
  }
  leaf image {
    type string;
    description "Image to use for this type of Network Function. Must have been
      be onboarded on the target VIM.";
  }
  leaf flavor {
    mandatory true;
    type string;
    description "Flavor to use for this type of Network Function. Must have been
      onboarded on the target VIM.";
  }
  list storage-volume {
    key id;
    description "Out of band Storage volumes to use for this network function";
    leaf id {
      type string;
    }
    leaf volume-name {
      type string;
      description "Storage Volume to use for this type of Network function";
    }
  }
  list connection-point {
    key name;
    description "Network connection point such as a network interface card, as
      defined in the descriptor.";
    leaf name {
      mandatory true;
      type nfv-common:identifier;
    }
  }

  list ip-address {
    key id;
    ordered-by user;
    leaf id {
      type uint8;
      tailf:info "IP Address ID for connection points";
    }
  }
}

```

```

    }
    leaf-list fixed-address {
        ordered-by user;
        description " IP address(es) to assign this network interface for both
scaled and non-scaled VNF's. Both IPv4 and
        IPv6 is possible to allow for dual-stack cases if this VNF requires
        it for Internet access.";
        type inet:ip-address;
    }
}

list vip {
    key address;
    ordered-by user;
    description " Virtual IP address(es) to assign this network interface. Both
IPv4 and IPv6 is possible to allow for dual-stack cases if this
VNF requires it for Internet access. Setting this will populate
allowed-address-pair list in the CVIM";

    leaf address {
        type inet:ip-address;
    }
    leaf netmask {
        type inet:ip-address;
        mandatory true;
    }
}
leaf-list security-group {
    type nfv-common:identifier;
    description "Security group(s) to apply to this network interface.";
}
leaf network-type {
    type leafref {
        path "../../network/type";
    }
    description "Network used for this connection-point.";
}
}
}
list extra-parameters {
    description "VNF instance specific additional parameters defined in the VNFD.
This will override the values configured in the VNFD";
    key name;
    leaf name {
        type string {
            pattern "[A-Za-z0-9_]+";
        }
    }
    leaf value {
        type string;
    }
}
}

list nfv-retry-vnfs {
    tailf:info "Retry VNF's to tweak the notifications";
    config false;
    tailf:cdb-oper {
        tailf:persistent true;
    }
    tailf:hidden nfv-internal;

    key name;

```

```

        leaf name {
            tailf:info "VNF Name";
            type string;
        }
    }
}

```

Appendix B: Generic Upgrade Steps of Mobility Function Pack (MFP)

This appendix covers the following procedures for:

- [Upgrading NSO 5.7.5.1-MFP 3.4.1 to NSO 5.8.10-MFP 3.4.2, on page 576](#)
- [Upgrading MFP 3.4.1 to MFP 3.4.2 without NSO Version Change, on page 582](#)

Upgrading NSO 5.7.5.1-MFP 3.4.1 to NSO 5.8.10-MFP 3.4.2

Use the following procedure to upgrade NSO 5.7.5.1-MFP 3.4.1 to NSO 5.8.10-MFP 3.4.2. This is an MFP version upgrade with simultaneous NSO version upgrade.

1. Copy the NSO 5.8.10 installation bin file to the `/tmp` folder and upgrade NSO to version 5.8.10.
2. Set the symbolic link to the new NSO version 5.8.10 under `/opt/ncs`.
3. Copy the packages and NEDs for MFP 3.4.2 and replace inside the `/var/opt/ncs/packages` folder.
4. Restart NSO with the **start-with-package-reload** option. This will upgrade MFP 3.4.1 to 3.4.2 along with NSO upgrade from NSO 5.7.5.1 to 5.8.10.

The following is a detailed procedure to upgrade NSO 5.7.5.1-MFP 3.4.1 to NSO 5.8.10-MFP 3.4.2.



Note If the upgrade is not completed, it is always recommended to take a backup for recovery later.

To backup the data, use the following configuration:

```

$ sudo su
# source /etc/profile.d/ncs.sh
# /etc/init.d/ncs stop
# ncs-backup
# exit
$

```

1. Run MFP 3.4.1 on NSO 5.7.5.1:

```

root@test-ns0:/var/opt/ncs# ncs --version
5.7.5.1

root@ncs# show packages package package-version
                PACKAGE
NAME            VERSION
-----
cisco-etsi-nfvo 4.7.2
cisco-rcm-nc-1.6 1.6
cisco-staros-cli-5.43 5.43.4

```

```

esc 5.7.0.73
etsi-sol003-gen-1.13 1.13.16
mobility-common 3.4.1
mobility-rcm-subscriber 3.4.1
mop-automation 3.4.1
mop-common 3.4.1
nfv-common 3.4.1
nfv-device-onboarding 3.4.1
nfv-vim 3.4.1
nfv-vnf-lcm 3.4.1
openstack-cos-gen-4.2 4.2.26

```

```

root@ncs# show packages package oper-status
packages package cisco-etsi-nfvo
oper-status up
packages package cisco-rcm-nc-1.6
oper-status up
packages package cisco-staros-cli-5.43
oper-status up
packages package esc
oper-status up
packages package etsi-sol003-gen-1.13
oper-status up
packages package mobility-common
oper-status up
packages package mobility-rcm-subscriber
oper-status up
packages package mop-automation
oper-status up
packages package mop-common
oper-status up
packages package nfv-common
oper-status up
packages package nfv-device-onboarding
oper-status up
packages package nfv-vim
oper-status up
packages package nfv-vnf-lcm
oper-status up
packages package openstack-cos-gen-4.2
oper-status up
root@ncs#

```

```

root@ncs# show devices list
NAME ADDRESS DESCRIPTION NED ID ADMIN STATE
-----
esc-etsi 64.1.0.6 - etsi-sol003-gen-1.13 unlocked
esc-netconf 64.1.0.6 - esc unlocked
openstack 10.225.202.49 - openstack-cos-gen-4.2 unlocked
root@ncs#

```

2. Instantiate a test VNF VPC-SI device using MFP 3.4.1 with NSO 5.7.5.1:

```

root@ncs#
System message at 2023-10-09 07:52:05...
Commit performed by ubuntu via http using rest.
root@ncs#
System message at 2023-10-09 07:52:05...
Commit performed by ubuntu via http using rest.
root@ncs#
System message at 2023-10-09 07:52:07...
Commit performed by ubuntu via http using rest.
root@ncs#
System message at 2023-10-09 07:52:07...
Commit performed by ubuntu via http using rest.

```

```

root@ncs#
System message at 2023-10-09 07:52:08...
Commit performed by ubuntu via http using rest.

root@ncs# show vnf-status instances S1-Test-00001 | tab
                                FUNCTION
-----
INSTANCE ID   TIMESTAMP                               TYPE      OPERATION   STATUS      STATUS
MESSAGE
-----
S1-Test-00001 2023-10-09 07:50:55.198 VPC-SI    deploy      init        init
                2023-10-09 07:51:38.595 VPC-SI    deploy      processing  processing
                2023-10-09 07:52:01.639 VPC-SI    deploy      processing  processing
                2023-10-09 07:52:03.997 VPC-SI    deploy      completed   completed
                2023-10-09 07:53:43.293 -          init        success     Device
Onboarding initialized
                2023-10-09 07:53:43.874 -          fetch-ssh-keys success
fetch-ssh-keys was successful
                2023-10-09 07:53:45.285 -          connect     success     connect
was successful
                2023-10-09 07:53:46.785 -          sync-from  success     sync-from
was successful
                2023-10-09 07:53:46.964 -          ready      success     Device
Successfully onboarded
                2023-10-09 07:54:13.305 -          config-read success     Config
MetaData is empty or null

root@ncs# show devices list
NAME          ADDRESS          DESCRIPTION      NED ID          ADMIN STATE
-----
S1-Test-00001 64.1.0.110      -               cisco-staros-cli-5.43  unlocked
esc-etsi      64.1.0.6        -               etsi-sol003-gen-1.13  unlocked
esc-netconf   64.1.0.6        -               esc               unlocked
openstack     10.225.202.49   -               openstack-cos-gen-4.2  unlocked
root@ncs#

```

3. Copy the NSO 5.8.10 installation bin file to the /tmp folder and NSO upgrade to version 5.8.10.

```

root@test-nso:/var/opt/ncs# cd /tmp
root@test-nso:/tmp# ls -lrt
total 397840
-rwxrwxrwx 1 ubuntu  ubuntu  203071802 Nov 18  2022
nso-5.7.5.1.linux.x86_64.installer.bin
drwx----- 3 root    root    4096 Sep 10 03:02
systemd-private-d7c0f02148d447358alb6b5995f1f339-systemd-resolved.service-O5tL4V
drwx----- 3 root    root    4096 Sep 10 03:02
systemd-private-d7c0f02148d447358alb6b5995f1f339-systemd-logind.service-Uj4bic
drwx----- 3 root    root    4096 Sep 10 03:02 snap.lxd
drwx----- 2 ubuntu  ubuntu  4096 Sep 12 09:45 ssh-WxVBdtyvgGzB
drwx----- 2 ubuntu  ubuntu  4096 Sep 12 19:28 ssh-kRFako4TgqJp
drwx----- 2 ubuntu  ubuntu  4096 Sep 12 20:25 ssh-wyrZqTmiA4o1
drwx----- 2 ubuntu  ubuntu  4096 Sep 12 20:50 ssh-a10wclKRgSP2
-rwxrwxrwx 1 ubuntu  ubuntu  204258218 Sep 13 05:38
nso-5.8.10.linux.x86_64.installer.bin
drwx----- 2 ubuntu  ubuntu  4096 Sep 13 12:21 ssh-ReWAFnmi3qS1
drwx----- 2 ubuntu  ubuntu  4096 Sep 13 12:54 ssh-dn1608f1nkaz
drwx----- 2 ubuntu  ubuntu  4096 Sep 20 05:49 ssh-DtgyHvctQ5S0
drwxr-xr-x 2 root    root    4096 Oct  9 07:01 hsperrfdata_root
drwxr-xr-x 2 nsoadmin nsoadmin 4096 Oct  9 07:01 hsperrfdata_nsoadmin

root@test-nso:/tmp# sh ./nso-5.8.10.linux.x86_64.installer.bin --system-install

```



```

--install-dir /opt/ncs --config-dir /etc/ncs --run-dir /var/opt/ncs --log-dir /var/log/ncs
--run-as-user nsoadmin --non-interactive
INFO Using temporary directory /tmp/ncs_installer.63734 to stage NCS installation bundle
INFO Using /opt/ncs/ncs-5.8.10 for static files
INFO Doing install for running as user nsoadmin
INFO Unpacked ncs-5.8.10 in /opt/ncs/ncs-5.8.10
INFO Found and unpacked corresponding DOCUMENTATION_PACKAGE
INFO Found and unpacked corresponding EXAMPLE_PACKAGE
INFO Found and unpacked corresponding JAVA_PACKAGE
INFO Generating default SSH hostkey (this may take some time)
INFO SSH hostkey generated
INFO Generating self-signed certificates for HTTPS
INFO Environment set-up generated in /opt/ncs/ncs-5.8.10/ncsrc
INFO NSO installation script finished
INFO Found and unpacked corresponding NETSIM_PACKAGE
cp: cannot stat '/sbin/arping': No such file or directory
WARN Failed to copy /sbin/arping command - capability not set
INFO Found ncs.crypto_keys, not migrating
INFO The following files have been installed with elevated privileges:
/opt/ncs/ncs-5.8.10/lib/ncs/lib/core/pam/priv/epam: setuid-root
/opt/ncs/ncs-5.8.10/lib/ncs/erts/bin/ncs.smp: capability cap_net_bind_service
/opt/ncs/ncs-5.8.10/lib/ncs/bin/ip: capability cap_net_admin

```

```
INFO NCS installation complete
```

```
root@test-nso:/tmp# /etc/init.d/ncs stop
Stopping ncs: .
```

```

root@test-nso:/tmp# cd /opt/ncs
root@test-nso:/opt/ncs# ls -lrt
total 24
drwxr-xr-x 17 root      root 4096 Oct  9 06:41 ncs-5.7.5.1
-rw-r--r--  1 root      root   9 Oct  9 06:41 user
-rw-r--r--  1 root      root  80 Oct  9 06:41 installdirs
lrwxrwxrwx  1 root      root  11 Oct  9 06:41 current -> ncs-5.7.5.1
drwxr-xr-x  2 nsoadmin root 4096 Oct  9 06:41 packages
drwxr-xr-x  2 nsoadmin root 4096 Oct  9 06:41 downloads
drwxr-xr-x 17 root      root 4096 Oct  9 09:43 ncs-5.8.10

```

Set the current NSO to version 5.8.10 using symbolic link

```

root@test-nso:/opt/ncs# rm -f current
root@test-nso:/opt/ncs# ln -s ncs-5.8.10 current

```

```

root@test-nso:/opt/ncs# ls -lrt
total 24
drwxr-xr-x 17 root      root 4096 Oct  9 06:41 ncs-5.7.5.1
-rw-r--r--  1 root      root   9 Oct  9 06:41 user
-rw-r--r--  1 root      root  80 Oct  9 06:41 installdirs
drwxr-xr-x  2 nsoadmin root 4096 Oct  9 06:41 packages
drwxr-xr-x  2 nsoadmin root 4096 Oct  9 06:41 downloads
drwxr-xr-x 17 root      root 4096 Oct  9 09:43 ncs-5.8.10
lrwxrwxrwx  1 root      root  10 Oct  9 09:44 current -> ncs-5.8.10

```

4. See the previous packages and NEDs for MFP 3.4.1 in the `/var/opt/ncs/packages` folder and replace with the newer packages and NEDs for MFP 3.4.2.

```

root@test-nso:/opt/ncs# cd /var/opt/ncs/packages/
root@test-nso:/var/opt/ncs/packages# ls -lrt
total 20104
-rw-rw-r--  1 ubuntu ubuntu 2191794 Jan 25  2023 ncs-5.7.5.1-cisco-rcm-nc-1.6.tar.gz
-rw-rw-r--  1 ubuntu ubuntu 2694132 Jan 25  2023 ncs-5.7.3-etsi-sol003-1.13.16.tar.gz
-rw-rw-r--  1 ubuntu ubuntu  655190 Jan 25  2023 ncs-5.7.2.1-esc-5.7.0.73.tar.gz
-rw-rw-r--  1 ubuntu ubuntu 2685815 Jan 25  2023 ncs-5.7.2.1-cisco-etsi-nfvo-4.7.2.tar.gz

```

```

-rw-rw-r-- 1 ubuntu ubuntu 2702317 Jan 25 2023 ncs-5.7.2-openstack-cos-4.2.26.tar.gz
-rw-rw-r-- 1 ubuntu ubuntu 9606799 Jan 25 2023 ncs-5.7.2-cisco-staros-5.43.4.tar.gz
-rwxrwxrwx 1 ubuntu ubuntu 435 Jan 25 2023 compile-all-packages.sh
-rwxrwxrwx 1 ubuntu ubuntu 275 Jan 25 2023 Ha-Mop.sh
drwxrwxr-x 6 ubuntu ubuntu 4096 Oct 9 06:55 nfv-common
drwxrwxr-x 7 ubuntu ubuntu 4096 Oct 9 06:56 nfv-device-onboarding
drwxrwxr-x 8 ubuntu ubuntu 4096 Oct 9 06:56 nfv-vim
drwxrwxr-x 9 ubuntu ubuntu 4096 Oct 9 06:57 nfv-vnf-lcm
drwxrwxr-x 8 ubuntu ubuntu 4096 Oct 9 07:00 mobility-common
drwxrwxr-x 7 ubuntu ubuntu 4096 Oct 9 07:01 mop-common
drwxrwxr-x 8 ubuntu ubuntu 4096 Oct 9 07:01 mobility-mop
drwxrwxr-x 7 ubuntu ubuntu 4096 Oct 9 07:01 mobility-rcm-subscriber

```

```

root@test-nso:/var/opt/ncs/packages# rm -rf *
root@test-nso:/var/opt/ncs/packages# ls -lrt
total 0
root@test-nso:/var/opt/ncs/packages#

```

Copy the MFP 3.4.2 packages along with NEDS:

```

root@test-nso:/var/opt/ncs/packages# ls -lrt
total 26328
-rw-rw-r-- 1 ubuntu ubuntu 2191794 Sep 25 05:40 ncs-5.7.5.1-cisco-rcm-nc-1.6.tar.gz
-rw-rw-r-- 1 ubuntu ubuntu 2694132 Sep 25 05:40 ncs-5.7.3-etsi-sol003-1.13.16.tar.gz
-rw-rw-r-- 1 ubuntu ubuntu 655190 Sep 25 05:40 ncs-5.7.2.1-esc-5.7.0.73.tar.gz
-rw-rw-r-- 1 ubuntu ubuntu 2685815 Sep 25 05:40 ncs-5.7.2.1-cisco-etsi-nfvo-4.7.2.tar.gz
-rw-rw-r-- 1 ubuntu ubuntu 2702317 Sep 25 05:40 ncs-5.7.2-openstack-cos-4.2.26.tar.gz
-rw-rw-r-- 1 ubuntu ubuntu 9606799 Sep 25 05:40 ncs-5.7.2-cisco-staros-5.43.4.tar.gz
-rw-rw-r-- 1 ubuntu ubuntu 824211 Sep 25 05:40 nfv-vnf-lcm.tar.gz
-rw-rw-r-- 1 ubuntu ubuntu 307054 Sep 25 05:40 nfv-vim.tar.gz
-rw-rw-r-- 1 ubuntu ubuntu 197449 Sep 25 05:40 nfv-device-onboarding.tar.gz
-rw-rw-r-- 1 ubuntu ubuntu 59217 Sep 25 05:40 nfv-common.tar.gz
-rw-rw-r-- 1 ubuntu ubuntu 3905393 Sep 25 05:40 mop-common.tar.gz
-rw-rw-r-- 1 ubuntu ubuntu 113829 Sep 25 05:40 mobility-rcm-subscriber.tar.gz
-rw-rw-r-- 1 ubuntu ubuntu 243790 Sep 25 05:40 mobility-mop.tar.gz
-rw-rw-r-- 1 ubuntu ubuntu 746045 Sep 25 05:40 mobility-common.tar.gz

```

5. Restart NSO with the `start-with-package-reload` option. This will upgrade MFP from 3.4.1 to 3.4.2 in NSO 5.8.10.

```

root@test-nso:/var/opt/ncs/packages# source /etc/profile.d/ncs.sh

root@test-nso:/var/opt/ncs/packages# /etc/init.d/ncs start-with-package-reload
Starting ncs: .

root@test-nso:/var/opt/ncs/packages# ncs --version
5.8.10

root@test-nso:/var/opt/ncs/packages# ncs_cli -C

root connected from 127.0.0.1 using console on test-nso
root@ncs# show packages package package-version
          PACKAGE
NAME      VERSION
-----
cisco-etsi-nfvo      4.7.2
cisco-rcm-nc-1.6     1.6
cisco-staros-cli-5.43 5.43.4
esc                5.7.0.73
etsi-sol003-gen-1.13 1.13.16
mobility-common     3.4.2
mobility-rcm-subscriber 3.4.2
mop-automation     3.4.2
mop-common          3.4.2

```

```

nfv-common          3.4.2
nfv-device-onboarding 3.4.2
nfv-vim             3.4.2
nfv-vnf-lcm        3.4.2
openstack-cos-gen-4.2 4.2.26

```

```

root@ncs# show packages package oper-status
packages package cisco-etsi-nfvo
  oper-status up
packages package cisco-rcm-nc-1.6
  oper-status up
packages package cisco-staros-cli-5.43
  oper-status up
packages package esc
  oper-status up
packages package etsi-sol003-gen-1.13
  oper-status up
packages package mobility-common
  oper-status up
packages package mobility-rcm-subscriber
  oper-status up
packages package mop-automation
  oper-status up
packages package mop-common
  oper-status up
packages package nfv-common
  oper-status up
packages package nfv-device-onboarding
  oper-status up
packages package nfv-vim
  oper-status up
packages package nfv-vnf-lcm
  oper-status up
packages package openstack-cos-gen-4.2
  oper-status up
root@ncs#

```

```

root@ncs# show devices list
NAME          ADDRESS      DESCRIPTION  NED ID          ADMIN STATE
-----
S1-Test-00001 64.1.0.110  -           cisco-staros-cli-5.43  unlocked
esc-etsi      64.1.0.6   -           etsi-sol003-gen-1.13  unlocked
esc-netconf   64.1.0.6   -           esc                unlocked
openstack     10.225.202.49 -           openstack-cos-gen-4.2  unlocked

```

6. Push the configuration with MFP 3.4.2 over NSO 5.8.10 using the mop-automation method to the test VNF VPC-SI device that got instantiated on previous MFP 3.4.1 and NSO 5.7.5.1:

```

root@test-nso:/var/opt/ncs# cat daylconfig.cfg
config
port ethernet 1/1
description test-description-1/1-by-mop18oct
no shutdown
exit

```

```

root@ncs# mobility-mop:action mop-automation generate-dry-run true operation-type commit
mop-type common mop-file-name { file-name daylconfig.cfg order 1 target-devices-list {
target-device-name S1-Test-00001 } } save-config-permanently true
task-id 036f5e94-364b-4d5f-a95e-4663fe5ed08a
time-stamp 2023-10-09T10:18:19+0000
time-zone Coordinated Universal Time
root@ncs#

```

```

root@ncs# mobility-mop:action mop-automation-status task-id

```

```

036f5e94-364b-4d5f-a95e-4663fe5ed08a
task-id 036f5e94-364b-4d5f-a95e-4663fe5ed08a
task-status COMPLETED
start-date 2023-10-09T10:18:19+0000
end-date 2023-10-09T10:18:23+0000
time-zone Coordinated Universal Time
operation-type commit
action-type save
devices-list {
  device-name S1-Test-00001
  device-status COMPLETED
  start-date 2023-10-09T10:18:19+0000
  end-date 2023-10-09T10:18:23+0000
  device-state common
  files {
    file-name day1config.cfg
    order 1
    dry-run-mop
/var/opt/ncs//036f5e94-364b-4d5f-a95e-4663fe5ed08a/S1-Test-00001/day1config_commit_2023-10-09T101819+0000.cfg

    rollback-mop
/var/opt/ncs//036f5e94-364b-4d5f-a95e-4663fe5ed08a/S1-Test-00001/day1config_rollback_commit_2023-10-09T101819+0000.cfg

    commit-queue-status completed
    commit-queue-id 1696846701998
  }
}

root@test-nso:/var/opt/ncs# cat
/var/opt/ncs//036f5e94-364b-4d5f-a95e-4663fe5ed08a/S1-Test-00001/day1configroot@test-nso:/var/opt/ncs#
cat
/var/opt/ncs//036f5e94-364b-4d5f-a95e-4663fe5ed08a/S1-Test-00001/day1config_commit_2023-10-09T101819+0000.cfg
config
port ethernet 1/1
  description test-description-1/1-by-mop18oct
exit
end

root@test-nso:/var/opt/ncs# cat
/var/opt/ncs//036f5e94-364b-4d5f-a95e-4663fe5ed08a/S1-Test-00001/day1configroot@test-nso:/var/opt/ncs#
cat
/var/opt/ncs//036f5e94-364b-4d5f-a95e-4663fe5ed08a/S1-Test-00001/day1config_rollback_commit_2023-10-09T101819+0000.cfg
config
port ethernet 1/1
  no description
exit
end

```

Upgrading MFP 3.4.1 to MFP 3.4.2 without NSO Version Change

Use the following procedure to upgrade MFP 3.4.1 to MFP 3.4.2 without changing the NSO version:

1. Copy the packages and NEDs for MFP 3.4.2 and replace inside the `/var/opt/ncs/packages` folder.
2. Perform packages reload in `ncs_cli` to see the upgraded MFP version 3.4.2. Restart NSO.

Appendix C: P2P Priority Upgrade

Use the following procedure to upgrade the P2P priority using the **mobility-library** action command:

1. Perform pre-checks including the P2P file placement and path settings followed by VNF instantiation:

```
[cloud-user@qwerty ncs]$ ncs --version
5.8.10

[cloud-user@qwerty ncs]$ ncs_cli -C

User cloud-user last logged in 2023-09-20T03:23:18.655123+00:00, to qwerty, from
10.65.51.122 using cli-ssh
cloud-user connected from 10.65.51.122 using ssh on qwerty
cloud-user@ncs# show packages package package-version
                PACKAGE
NAME            VERSION
-----
cisco-etsi-nfvo      4.7.2
cisco-rcm-nc-1.6    1.6
cisco-staros-cli-5.43 5.43.4
esc                 5.7.0.73
etsi-sol003-gen-1.13 1.13.16
mobility-common     3.4.2
mobility-rcm-subscriber 3.4.2
mop-automation     3.4.2
mop-common         3.4.2
nfv-common         3.4.2
nfv-device-onboarding 3.4.2
nfv-vim           3.4.2
nfv-vnf-lcm       3.4.2
openstack-cos-gen-4.2 4.2.26

cloud-user@ncs# show packages package oper-status
packages package cisco-etsi-nfvo
oper-status up
packages package cisco-rcm-nc-1.6
oper-status up
packages package cisco-staros-cli-5.43
oper-status up
packages package esc
oper-status up
packages package etsi-sol003-gen-1.13
oper-status up
packages package mobility-common
oper-status up
packages package mobility-rcm-subscriber
oper-status up
packages package mop-automation
oper-status up
packages package mop-common
oper-status up
packages package nfv-common
oper-status up
packages package nfv-device-onboarding
oper-status up
packages package nfv-vim
oper-status up
packages package nfv-vnf-lcm
oper-status up
packages package openstack-cos-gen-4.2
oper-status up

[cloud-user@qwerty ncs]$ ls -lrt
total 4740
drwxrwxrwx. 2 nsoadmin root          6 Sep  5 03:36 scripts
drwxrwxrwx. 2 nsoadmin root          6 Sep  5 03:36 streams
drwxrwxrwx. 2 nsoadmin root          6 Sep  5 03:36 backups
```

```

-rwxrwxrwx. 1 nsoadmin root 1513 Sep 5 03:36 INSTALLATION-LOG
drwxrwxrwx. 3 nsoadmin nsoadmin 22 Sep 5 03:37 target
drwxrwxrwx. 7 cloud-user cloud-user 204 Sep 5 03:56 vnfpackages
-rwxrwxrwx. 1 root root 87 Sep 5 06:26 daylconfig.cfg
-rwxrwxrwx. 1 root root 31 Sep 5 06:47 rcm-daylconfig.cfg

-rwxrwxrwx. 1 root root 4253395 Sep 8 03:19 patch_libp2p-2.69.0.1534.so.tgz

-rwxrwxrwx. 1 cloud-user cloud-user 142 Sep 10 14:11 daynconfig.cfg

drwxrwxrwx. 10 nsoadmin root 4096 Sep 18 02:20 packages
-rwxrwxrwx. 1 nsoadmin nsoadmin 333 Sep 18 02:31 storedstate

drwxrwxrwx. 2 nsoadmin root 98 Sep 18 08:59 cdb

drwxrwxrwx. 2 nsoadmin root 20480 Sep 19 23:23 rollbacks
drwxrwxrwx. 5 nsoadmin root 4096 Sep 19 23:26 state

```

```

cloud-user@ncs# config
Entering configuration mode terminal
cloud-user@ncs(config)# configurable-parameters p2p-required true
cloud-user@ncs(config)# configurable-parameters p2p-soFile-path
/var/opt/ncs/patch_libp2p-2.69.0.1534.so.tgz
cloud-user@ncs(config)# commit
Commit complete.
cloud-user@ncs(config)# exit

```

```

cloud-user@ncs# show vnf-status instances UP-Test001-p2p
FUNCTION

```

INSTANCE ID	TIMESTAMP	TYPE	OPERATION	STATUS	STATUS
UP-Test001-p2p	2023-09-19 23:29:42.335	VPC-SI	deploy	init	init
	2023-09-19 23:30:19.377	VPC-SI	deploy	processing	processing
	2023-09-19 23:30:47.948	VPC-SI	deploy	processing	processing
	2023-09-19 23:30:49.269	VPC-SI	deploy	completed	completed
	2023-09-19 23:31:55.555	-	init	success	Device
Onboarding initialized	2023-09-19 23:31:56.061	-	fetch-ssh-keys	success	
fetch-ssh-keys was successful	2023-09-19 23:31:57.005	-	connect	success	connect
was successful	2023-09-19 23:31:58.353	-	sync-from	success	sync-from
was successful	2023-09-19 23:31:58.523	-	ready	success	Device
Successfully onboarded	2023-09-19 23:37:29.386	-	config-read	success	Config
MetaData is empty or null					

```

[cloud-user@qwerty ncs]$ ssh admin@64.1.0.96
The authenticity of host '64.1.0.96 (64.1.0.96)' can't be established.
RSA key fingerprint is SHA256:TKCq17DQvty520Hp8WzGt01YKiloAtEmMt1xAMQ23a0.
Are you sure you want to continue connecting (yes/no/[fingerprint])? Cscso@123
Please type 'yes', 'no' or the fingerprint: yes
Warning: Permanently added '64.1.0.96' (RSA) to the list of known hosts.
Cisco Systems QvPC-SI Intelligent Mobile Gateway
admin@64.1.0.96's password:
Last login: Tue Sep 19 23:32:04 -0400 2023 on pts/1 from 64.1.0.7.

```

```

No entry for terminal type "xterm-256color";
using dumb terminal settings.

[local]vpc-si# show module p2p verbose
Module p2p
  Priority card version loaded location update/rollback time status
    99 1 2.69.1534 2/2 /var/opt/lib Tue Sep 19 23:32:35 2023 success
      X 1 1.161.656 0/2 /lib (never) N/A
      <<<<<<< p2p priority starting from 99 instead of 10

[local]vpc-si#
[local]vpc-si#
[local]vpc-si# exit
Connection to 64.1.0.96 closed.
[cloud-user@qwerty ncs]$
[cloud-user@qwerty ncs]$
[cloud-user@qwerty ncs]$ ncs_cli -C

User cloud-user last logged in 2023-09-20T03:30:52.813071+00:00, to qwerty, from
10.65.51.122 using rest-http
cloud-user connected from 10.65.51.122 using ssh on qwerty
cloud-user@ncs#
cloud-user@ncs#

```

2. Use the **mobility-library** action command for the actual upgrade of P2P priority:

```

cloud-user@ncs# mobility-library configure-library library-name p2p device-list {
device-name UP-Test001-p2p }
status success
message Configured Successfully

cloud-user@ncs#
cloud-user@ncs#
cloud-user@ncs# exit
[cloud-user@qwerty ncs]$ ssh admin@64.1.0.96
Cisco Systems QvPC-SI Intelligent Mobile Gateway
admin@64.1.0.96's password:
Last login: Tue Sep 19 23:41:37 -0400 2023 on pts/1 from 64.1.0.7.

No entry for terminal type "xterm-256color";
using dumb terminal settings.

[local]vpc-si# show module p2p verbose
Module p2p
  Priority card version loaded location update/rollback time status
> 98 1 2.69.1534 2/2 /var/opt/lib Tue Sep 19 23:41:39 2023 success
* 99 1 2.69.1534 2/2 /var/opt/lib (never) N/A
  X 1 1.161.656 0/2 /lib (never) N/A

> current module priority is 98
* some modules have not unloaded from the p2p application and are still in use

[local]vpc-si#

```



CHAPTER 61

NSH Traffic Steering

- [Revision History](#), on page 587
- [Feature Description](#), on page 587
- [How it Works—Standalone Mode](#), on page 592
- [Configuring the L2 and NSH Traffic Steering Feature—Standalone Mode](#), on page 596
- [Monitoring and Troubleshooting—Standalone Mode](#), on page 605
- [Feature Description—Sandwich Mode](#), on page 612
- [How it Works—Sandwich Mode](#), on page 614
- [Configuring NSH Traffic Steering—Sandwich Mode](#), on page 619
- [Configuring Post Processing Ruledef in Both Standalone and Sandwich Mode](#), on page 622
- [Configuring BFD Instance Id Using Interface Name in UP Appliance Group](#), on page 622
- [Monitoring and Troubleshooting the NSH Traffic Steering—Sandwich Mode](#), on page 623

Revision History



Note Revision history details are not provided for features introduced before release 21.24.

Revision Details	Release
The support for post processing rule condition match for Traffic Steering and L2 up-appliance-group BFD configuration is available in this release.	21.23.22
With this release, support is added for post processing rule condition match for Traffic Steering, and L2 up-appliance-group BFD configuration that can be done using the interface name.	21.27
First introduced.	Pre 21.24

Feature Description

The 3GPP EPC architecture enables data traffic steering across various service functions on the Gi interface. The traffic steering architecture is based on the Network Service Header (NSH) service chaining protocol.

The EPC gateway needs to perform the traffic steering to steer the traffic across the multiple service chains containing the appliances which support NSH.

The following are the two modes of NSH Traffic Steering:

- Standalone Mode
- Sandwich Mode

This feature enables the charging and steering of traffic to be independent of each other based on the customer's requirement. It is possible for customers to include a large set of traffic categories for steering traffic with minimum configurational enhancements within the existing use case scenarios.

Post Processing Rule Condition Match for Traffic Steering

A simple traffic classification helps in simplifying the operation and configuration processes in traffic steering due to the huge number of the charging rules across multiple rulebases.

- Trigger condition in service scheme framework supports post processing ruledef name match.
- The L3/L4 ruledef which is configured as a post processing rule for traffic is traffic-steered.
- Trigger action supports trigger condition of post processing rule match for traffic steering.
- The post processing ruledef name in trigger condition is supported in PFD push and RCM.

BFD Instance Id Configuration in UP Appliance Group Using Interface Names

For traffic steering, the configuration of Bidirectional Forwarding Detection (BFD) instance id in the **up-appliance-group** is enabled using interface names along with IP configuration.

Architecture—Standalone Mode

The following figure illustrates the architectural setup for CUPS based gateway for NSH appliances.

Figure 40: NSH Traffic Steering Architecture—Standalone Mode

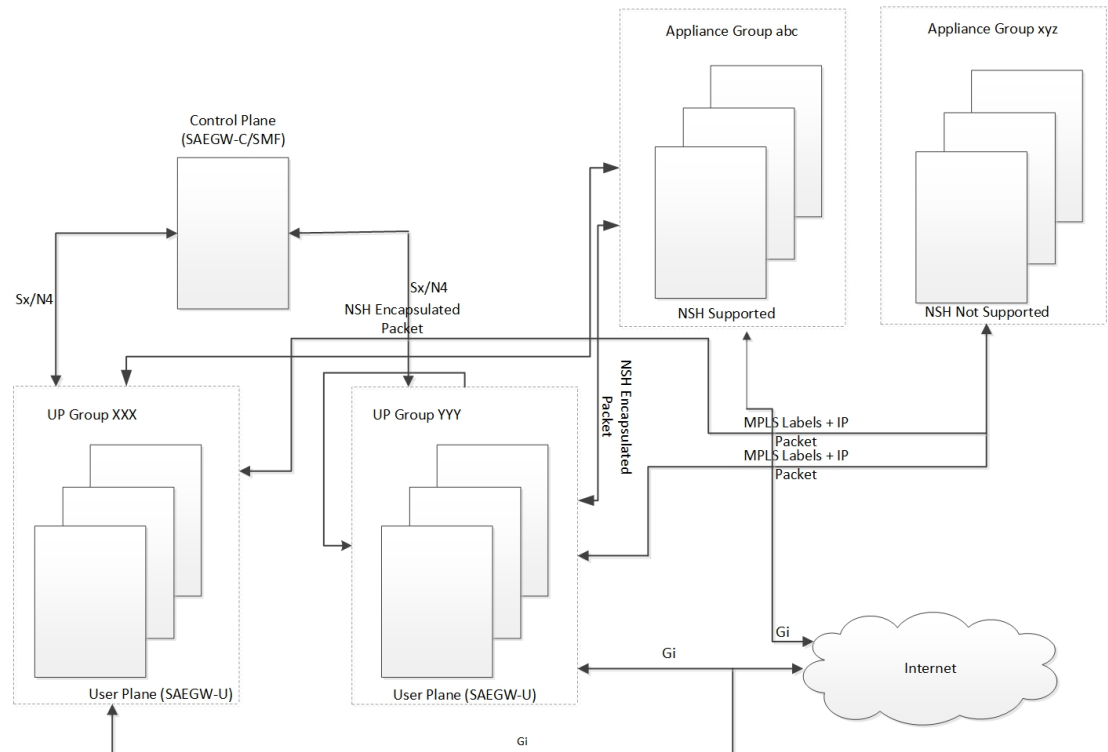

448384

The feature supports a service function chain for NSH supported appliances. The gateway is configured to select a suitable steering or encapsulation method for steering traffic that is based on each appliance instance or group.

Table 47: Call Flow

Step	Description
1.	UL packet received at the SAEGW-U is classified based on the configured policy associated with the appropriate SFC.
2.	The Saegw performs the SFP selection based on the stickiness (MSISDN stickiness) or service and load availability of the SFPs. The UL traffic is NSH (IP-UDP) encapsulated steered on the selected SFP with the context header populated as necessary.
3.	The NSH appliance on receiving the NSH Packet, processes the IP packet (and possibly the context header) and sends the packet over the Gi interface.
4.	Destination server sends the DL packet from the Gi interface to the SAEGW-U. The DL traffic is NSH (IP-UDP) encapsulated steered on the selected SFP with the context header populated as necessary.

Step	Description
5.	The NSH appliance on receiving the NSH Packet, processes the IP packet (and possibly the context header) and hairpin the packet back to the SAEGW-U.
6.	The SAEGW-U on receiving the NSH packet: <ul style="list-style-type: none"> • Decapsulates the received payload • Processes the IP packet (and possibly the context header) and send the packet over the Gn interface to the UE

Components

The traffic steering architecture comprises of the following main components:

Control Plane (SAEGW-C)

CP sends information to UP on how to steer the subscriber's traffic. The UP steers all or only part of the subscriber data traffic that is based on policies that are defined for the subscriber. It's possible to steer different types of subscriber traffic to different service function chains.

CP selects the service chain name for a subscriber after it receives the Ts-subscription-scheme AVP from PCRF, which is based on locally configured policies.

User Plane (SAEGW-U)

Based on the policy, which UP receives from CP, it steers the subscriber data traffic to one or more service function chains.

UP also performs the following functions:

- Select a Service Function Path (SFP) for a particular Service Function Chain (SFC).
- Maintain subscriber stickiness while forwarding traffic toward the appliances.
- If a node or an appliance fails, reselect and steer the subscriber data traffic to a new node.
- Manage **In-Service** and **Out-of-Service** status for SFPs.
- Manage SFC status depending on the number of serviceable SFPs available within an SFC.

NSH

For monitoring health of the NSH appliance, each SAEGW-U/UPF is responsible for monitoring of the appliance load and serviceability stat.

- Use the OAM NSH packet mechanism to monitor the status of the appliances.
- The monitoring frequency for the configuration is (1-20 secs) with a default interval of 1 sec.
- In case the OAM request times out. Do the retry. The timeout and the retry value are configurable with values of 1-5 secs for timeout (default of 3 secs) and 1-3 retries (default of two retries).

- In addition to the appliance serviceability status, the current load on the appliance is under observation. Monitor the current load in order to maintain the optimum load balancing among various instances of an SF. This load status returns through the NSHs OAM response packet.

Limitations

The NSH traffic steering has the following limitations:

- On NSH appliance, make sure that the interface fragmentation doesn't happen. Keep the MTU towards the NSH appliance interface bigger than Gn/Gi interface.
- For HTTP pipelined sessions, mid flow HTTP partial packets, and TCP Out of order packets, if requires an SFP reevaluation with L7 conditions, doesn't reach the NSH appliance.
- If you remove the SFP ID configuration from the main configuration, show configuration still shows the SFP ID. The SFP ID goes away once committed to VPP, using the commit CLI.
- Traffic steering statistics indicate the packets which are candidate for traffic steering. In traffic steering statistics those packets are also counted which are dropped by quota exhaust, though they still are the candidates for traffic steering.
- If modification of NSH SRC/bind IP address OR appliance IP address is required in the configuration for any NSH appliance's instance, then you need to remove the instance, then SFPs associated with it, put the SFPs and new instance with modified IP addresses. Perform the commit afterwards.
- When node failure is done and continuous data is coming, then there can be discrepancy in steering statistics. Data steered on SFPs which is going down is not reflected in statistics.
- For multi PDN call, NSH instance stickiness is restricted to each subscriber session.
- In case of a change in the state at the SAEGW-U due to ICSR or config change like SFP removal in the interim period, there is a possibility that packets which are being hair pinned back from the appliance in this window can be dropped. All further incoming packets are processed as normal
- In case of the first packet of a flow being a DL packet (session recovery), just that first packet is dropped. However, the retransmitted packet and all subsequent packets are sent out as normal.
- In case of change in the NSH format tags, tag types stream-fp-md encode, reverse-stream-fp-md , secondary-srv-path-hdr, and rating-group comes into effect for new flows and not for existing flows. Any changes for the remaining tags in the NSH format applies for new sessions while traffic on existing sessions continue with older format tags. In such cases, particularly in case of modification and deletion of tags, the appliance can mismatch the tag values received in the NSH packets and can lead to ambiguous behavior. So, perform the NSH-format type changes carefully.
- Server initiated TCP Flows are not considered for Traffic steering.
- Monsub support for capturing NSH traffic is not currently available.
- For addressing any appliance level limitation (example - traffic type), policy selection configuration on the service scheme provides the flexibility to filter out such traffic from selecting a service chain containing such appliance.
- For N:M setup, service scheme config (trigger action, trigger condition, service-scheme, subscriber class, and subscriber base) needs to be configured in Day-0 config on UP. Service scheme when configured, in common config on UP, is hitting a race condition leading to service scheme not getting configured on user-plane sessmgrs intermittently, which leads to failure of traffic steering functionality.

- OAM stats for L2 steering is partially supported.
- For HTTP concatenated packet, the packet is traffic steered based on the policy matched by the last HTTP GET in the packet.
- In case a appliance goes down, the flow gets unloaded for reevaluation when the next uplink packet is recovered on the flow. Post which the a new SFP selection happens and the traffic is steered to the new appliance.

How it Works—Standalone Mode

Packet Flows

This section describes the packet flows for the NSH traffic steering architecture.

Uplink Packets

Figure 41: Uplink Packet Flow

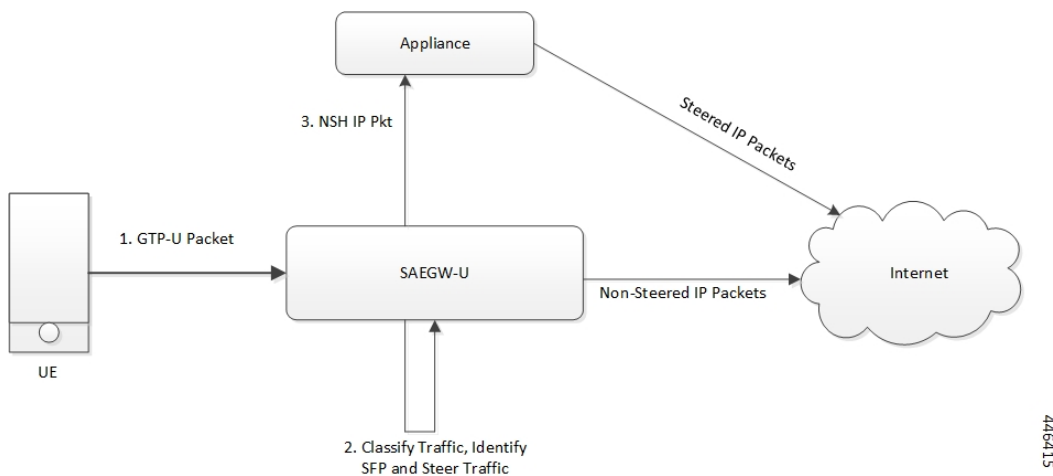

Table 48: Uplink Packet Flow Description

Steps	Description
1	UE sends the subscriber data packets to SAEGW-U.
2	SAEGW-U classifies the subscriber data traffic that is based on subscriber policies, and identifies an SFC to select an SFP accordingly.
3	SAEGW-U steers the Uplink (UL) packets with NSH encapsulation as per NSH RFC and sends to NSH appliance. SAEGW-U sends the non-steered IP packets to the server.
4	NSH supported appliance on receiving uplink packet, takes the decision to forward the packet to server based on certain criteria.

Downlink Packets

Figure 42: Downlink Packet Flow

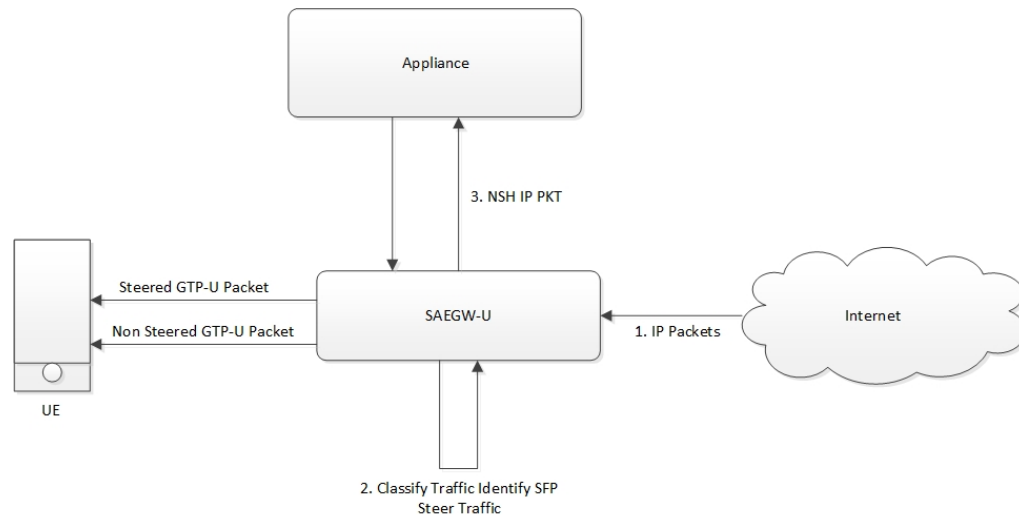

Table 49: Downlink Packet Flow Description

Steps	Description
1	SAEGW-U receives the Downlink (DL) packets from the server.
2	SAEGW-U selects an SFP.
3	SAEGW-U adds metadata as NSH context header and forwards it to the NSH supported appliance.
4	The NSH supported appliance sends back the packets to the SAEGW-U with the some metadata tags,as sent by SAEGW-U.
5	On receiving the packets, SAEGW-U classifies the subscriber data traffic that is based on subscriber charging policies.
6	SAEGW-U sends the data packets to the subscriber.

NSH Traffic Steering Requirements

Following is the behavior for integration of NSH appliances in the Traffic steering solution:

- SAEGW-U maintains the session stickiness of NSH appliance and ensure that all flows of a subscriber session end up selecting the same appliance instance.
- There's a configurable option to define the load capacity for every appliance instance, example 50%, 100%. If the load status by the NSH appliance exceeds this threshold, only existing subscribers can continue with such instance. This instance doesn't allocate to any new subscriber until the load status falls below the threshold.

- If NSH appliance detects as DEAD, all traffic on SFPs engaging this appliance instance is reclassified and traffic moves to a different appliance instance. Such appliance isn't available for new subscriber selection once it comes back ALIVE.
- Traffic Steering can be enable/disable in midsession. If you enable the traffic steering in between, then it's applicable to new flows. Old flows continue without traffic-steering.
- SR/ICSR support for traffic-steering Post SR/ICSR session stickiness is maintained.
- In case of multi appliance SFP, there are two forms of configurations:
 - For cases where appliances need to see start of traffic (example - TWH Packets), an SFP is selected which engages all appliances. As per the configuration policies, when the classification happens, the traffic can fall out of ineligible appliances.
 - For cases where appliances engage in mid flow, the configuration is such that appliances engage once the certain appliances become eligible further to traffic classification.
- Traffic steering statistics indicate the packets which are candidate for traffic steering. For traffic steering statistics, those packets are also counted which are dropped by quota exhaust, though they are the candidates for traffic steering.
- When node failure is done and continuous data is coming, then there can be discrepancy in steering statistics. Data steered on SFPs which is going down is not reflected in statistics.
- If you want to modify the NSH remote IP add or SRC bind IP in the configuration for any NSH appliance instance:
 - Then remove the instance.
 - Then remove the SFPs associated with it.
 - Put the SFPs and new instance with modified IP addresses.
 - Perform the commit afterwards.

This feature supports the following Traffic steering system limits:

Traffic steering object	Max Limit
Total Appliance groups	16
Total Instances per Appliance Group	256
Total SFCs	16
Total SFPs	64000

Default Service Chain

For operator, there could be certain use cases, where all traffic for a subscriber who has traffic steering enabled, needs to traverse through certain appliance(s). In order to cater to such requirement while providing an easy configuration mechanism to achieve that, the concept of a default service chain has been brought in. For e.g. if the subscriber is engaged on a subscriber with 2 appliances, APP1 and APP2, where APP2 needs to see all the traffic, a service chain containing APP2 would be configured as the default service chain.

Thus, for a traffic steering enabled subscriber, there could be unavailability of service chain APP1+APP2 for certain traffic due the following conditions:

- There is no suitable policy configured for certain flows which would select the APP1+APP2 service chain.
- APP1+APP2 service chain was selected ,but APP1 instances went down below the min instance threshold. In such case the APP1+APP2 service chain will not be available.
- APP1+APP2 service chain was selected but no SFP could be selected.

Under such cases due to service chain unavailability, the flows would fall back to the configured default service chain thus ensuring APP2 service treatment to the flows.

If a default service chain, however, if not configured, will lead to the traffic being sent out non-steered.

SFP Selection

SFP selectios is based on the:

- MSISDN Stickiness (preconfigured) or
- Load Availability

MSISDN Stickiness

MSISDN Stickiness depends on the MS-ISDN and it provides the corresponding node. If the node is available and is part of the SFP, then that SFP is selected for the data (UL/DL). Presently, MSISDN stickiness is available for the L2 nodes only and there can be a service chain having L2 nodes alone or with a mix of L2 and NSH. All SFPs of the service chain have same set of type of nodes, where type can be of L2 or L2 + NSH or NSH (only).

Subscriber Stickiness (for both L2 and NSH) is maintained for the subscriber across the service chains till that node is available and when node goes down or removed from the config, subscriber can move to a different SFP (based on SFP selection). In case of stickiness miss, logs and traps are generated.

Load Availability

Load availability is load capacity, current load is maintained for each SFP (minimum of all instances that are part of the SFP). The SFPs are classified as part of available, overloaded or blocked list based on load availability. Only available-list and overloaded-list are being used for SFP selection as blocked-list is for SFPs for which node is down. Available-list SFPs are available for both old and new calls/sessions. Overloaded-list (load availability =0) is only used for maintaining the stickiness (if any), that is for old calls/sessions only. SFPs, once selected may move to overloaded-list because of load and for maintaining the stickiness. Same SFPs are used for the old calls/sessions and new calls use the remaining SFPs of the available-list for SFP selection.

Interworking with Inline Features

Support for interworking with the following inline features is not in the scope of the existing implementation.

- IPv4/v6 Readdressing
- NAT44 and NAT64

- Next Hop Forwarding
- L2 Marking

The encoding of rating group in the NSH context header is supported aligned with the following expected behaviour:

- The encoded rating group value corresponds to the rule that each packet matches. So, in a single flow's packets, the rating group either changes or is not encoded as the flow moves across different rules with different rating groups configured/or not configured.
- The SAE-GW populates the rating group value, if configured, in the rating group field. If only content id is configured then this value is populated in the field. In the event that none are associated with the packet's matching rule, no TLV field corresponding to the rating group is sent.
- In case SAE-GW performs a deferred rule match and send out the packets without a rule match, it doesn't encode the rating group TLV for such packets.

Configuring the L2 and NSH Traffic Steering Feature—Standalone Mode

The following sections provide information about the CLI commands available to configure the L2 and NSH traffic steering CUPS feature in both CP and UP.

Configuring the Control Plane

Perform the following steps to configure the CP:

1. The following CLI command is a sample configuration to configure CP under the active-charging service.

```

configure
  active-charging service ACS
  policy-control services-framework

  trigger-action ta1
    up-service-chain sc_L3
  exit
  trigger-action ta2
    up-service-chain L3
  exit

  trigger-condition tc1
    rule-name = rule1
    rule-name = rule2
    multi-line-or
  exit

  trigger-condition tc2
    any-match = TRUE
  exit

  service-scheme scheme1
    trigger rule-match-change
      priority 1 trigger-condition tc1 trigger-action ta1
    exit
    trigger subs-scheme-received
      priority 1 trigger-condition tc2 trigger-action ta2
  
```

```

exit

subs-class class1
  subs-scheme = s1
exit
subscriber-base base1
  priority 1 subs-class class1 bind service-scheme scheme1
exit
end

```

NOTES:

- **subs-scheme:** The name should match the subscription-scheme AVP value that is received from PCRF over the Gx interface.
 - **up-service-chain SecNet:** The value must match the up-service-chain that is configured on UP.
 - **rule-name:** The value can be static/predef/gor/dynamic rules.
2. Traffic steering AVPs are currently supported with the Diameter dictionary custom44. The Diameter dictionary enables CP to properly decode the TS-related AVPs when they are received over the Gx interface and sent in Sx message to UP.

The following is an example configuration to configure the Dictionary in CP.

```

configure
context ISP1
  ims-auth-service IMSGx
  policy-control
  diameter dictionary dpca-custom44
exit
end

```

Following are the sample values for TS-related AVPs received over GX in CCA-I/CCA-U/RAR.

```

[V] Services:
[V] Service-Feature:
[V] Service-Feature-Type: TS (4)
[V] Service-Feature-Status: ENABLE (1)
[V] Service-Feature-Rule-Install:
[V] Service-Feature-Rule-Definition:
[V] Service-Feature-Rule-Status: ENABLE (1)
[V] Subscription-Scheme: scheme
[V] Profile-Name: Gold

```

Configuring the User Plane

Perform the following steps in same sequence to configure the UP:

The following CLI command is a sample configuration to add an interface in the contexts, which are used to send data toward L2 and NSH supported appliance.

1. Add the interface in the contexts which will be used to send data toward the L2 and NSH supported appliance.

The following is a sample configuration:

```

configure
require tsmon
end
configure
context ISP1-UP
interface <ts_ingress>

```

```

ip address <ip_address>
ipv6 address <ipv6_address_secondary>
exit
end

configure
context ISP2-UP
interface <ts_egress>
ip address <ip_address>
ipv6 address <ipv6_address_secondary>
exit
end

```

2. Bind these newly-added interfaces to the physical ports of the UP.

The following is an example configuration:

```

configure
port ethernet 1/11
vlan 1240
no shutdown
bind interface ts_ingress ISP1-UP
exit
exit
port ethernet 1/12
vlan 1240
no shutdown
bind interface ts_egress ISP2-UP
exit
exit
end

```

3. Add the TS-related configuration in the UP.

The following is an example configuration:

```

config

ts-bind-ip IP_UP01 ipv4-address 209.165.200.225 ipv6-address 4001::106

nsh
node-monitor ipv4-address 209.165.200.226 ipv6-address 4001::107 poll-interval 1
retry-count 2 load-report-threshold 5 (node-monitor is mandatory for NSH appliances,
default values are poll-interval=1, retry-count=2, load-report-threshold=5)
up-nsh-format format1
tag-value 250 imsi encode
tag-value 66 msisdn encode
tag-value 4 rating-group encode
tag-value 1 stream-fp-md encode decode
tag-value 2 reverse-stream-fp-md encode decode
tag-value 76 subscriber-profile encode
tag-value 3 secondary-srv-path-hdr encode
tag-value 5 rat-type encode
tag-value 51 mcc-mnc encode
tag-value 255 apn encode
tag-value 25 sgsn-address encode
#exit
#exit
traffic-steering
up-service-chain sc_L3
sfp-id 9 direction uplink up-appliance-group L2 instance 1 up-appliance-group L3
instance 1
sfp-id 10 direction downlink up-appliance-group L3 instance 1 up-appliance-group
L2 instance 1
sfp-id 11 direction uplink up-appliance-group L2 instance 2 up-appliance-group L3

```

```

instance 1
  sfp-id 12 direction downlink up-appliance-group L3 instance 1 up-appliance-group
L2 instance 2
  sfp-id 13 direction uplink up-appliance-group L2 instance 1 up-appliance-group L3
instance 2
  sfp-id 14 direction downlink up-appliance-group L3 instance 2 up-appliance-group
L2 instance 1
  sfp-id 15 direction uplink up-appliance-group L2 instance 2 up-appliance-group L3
instance 2
  sfp-id 16 direction downlink up-appliance-group L3 instance 2 up-appliance-group
L2 instance 2
  sfp-id 17 direction uplink up-appliance-group L2 instance 3 up-appliance-group L3
instance 1
  sfp-id 18 direction downlink up-appliance-group L3 instance 1 up-appliance-group
L2 instance 3
  sfp-id 19 direction uplink up-appliance-group L2 instance 4 up-appliance-group L3
instance 1
  sfp-id 20 direction downlink up-appliance-group L3 instance 1 up-appliance-group
L2 instance 4
  sfp-id 21 direction uplink up-appliance-group L2 instance 3 up-appliance-group L3
instance 2
  sfp-id 22 direction downlink up-appliance-group L3 instance 2 up-appliance-group
L2 instance 3
  sfp-id 23 direction uplink up-appliance-group L2 instance 4 up-appliance-group L3
instance 2
  sfp-id 24 direction downlink up-appliance-group L3 instance 2 up-appliance-group
L2 instance 4
#exit
up-service-chain L3
  sfp-id 1 direction uplink up-appliance-group L3 instance 1
  sfp-id 2 direction downlink up-appliance-group L3 instance 1
  sfp-id 3 direction uplink up-appliance-group L3 instance 2
  sfp-id 4 direction downlink up-appliance-group L3 instance 2
#exit
up-appliance-group L3
  steering-type nsh-aware
  up-nsh-format format4
  min-active-instance 1
  instance 1 ip address 40.40.40.3
  instance 2 ip address 40.40.40.4
#exit
up-appliance-group L2
  steering-type l2-mpls-aware
  min-active-instance 1
  instance 1 ingress slot/port 1/13 vlan-id 2136 egress slot/port 1/12 vlan-id 2136
  ingress-context ingress ip address 4101::1 egress-context egress ip address 4101::2
  instance 2 ingress slot/port 1/13 vlan-id 2137 egress slot/port 1/12 vlan-id 2137
  ingress-context ingress ip address 4201::1 egress-context egress ip address 4201::2
  instance 3 ingress slot/port 1/13 vlan-id 2138 egress slot/port 1/12 vlan-id 2138
  ingress-context ingress ip address 4301::1 egress-context egress ip address 4301::2
  instance 4 ingress slot/port 1/13 vlan-id 2139 egress slot/port 1/12 vlan-id 2139
  ingress-context ingress ip address 4401::1 egress-context egress ip address 4401::2
#exit

```

4. Verify the above configurations using **show configuration** CLI command. Then, execute the **commit** CLI command for the configurations to be effective.

```

configure
  traffic-steering
    commit
end

```

Configuration Guidelines

This section describes the following guidelines that are required to properly configure the feature:

- Configure the TS-related configuration on UP in the same sequence as mentioned in the preceding sections. This method ensures that the interfaces used to steer traffic toward L2 are applied properly in the configuration.
- If the instance under up-appliance-group has to be modified or deleted, then all the associated sfp-id under up-service-chain must be removed or deleted first.
- If the preceding modification must be done to the associated instance and sfp-id after a call is initiated, then remove the sfp-ids and reconfigure them to avoid any issues.
- Apply any changes to the interface before configuring the up-appliance-group instance. If the changes to the interface are applied at a later stage, remove the up-service-chain configuration first and then the up-appliance-group configuration. After the interface modification is complete, reconfigure the service chain and appliance group.
- The entire UP service chain and appliance group must not be removed to remove an interface or sfpid.

N to M Traffic Steering

Following are the configuration steps for the N:M Traffic Steering:

1. Configure TS-bind ip in RCM host specific configuration for all active UPs.
2. Configure the required active charging ruledef, rulebase configurations and traffic steering configurations (up-nsh format, up-appliance-group and up-service-chain, commit CLI) in common configuration in RCM and do commit.
3. Reload the active and standby UP with Day-0 config which has require ts-mon, RCM config, node monitor CLI for L3 server monitoring, BFD related interfaces configuration for L2, and service schema config for traffic steering (trigger condition, trigger action and so on).
4. Check RCM pushes config to all UPs. Check all services are up on all the UPs.
5. Check that the VPP fastpath tables have SST, SSMT, and SST tables created. Also check global tables are created correctly.
6. Check the up-service-chain SFP status and make sure that the SFPs are in available state.

Configuration

Following are the sample configurations:

- **Day-0 config** : The following configurations are part of Day-0 config.
 - Require ts-mon and Node-monitor CLI to monitor L3 appliance as mentioned in the earlier configuration section. Each UP has its own physical IP to monitor L3 appliance.
 - BFD related interfaces configuration for L2. Vlan configuration and IP interface related configuration.
 - Service schema configuration (Trigger condition, service scheme and so on).



Note Optimisation is planned to move service schema configuration to common configuration. Currently if service schema configuration needs to be modified then changes needs be done manually on all the UPs.

UP Sample Configuration

L3 Monitoring

```

config
require ts-mon
nsh
node-monitor ipv4-address 209.165.200.227 poll-interval 5 retry-count 5
load-report-threshold 20
exit

interface ISP1_TO_PDN
ip address 209.165.200.227 255.255.255.224
ipv6 address 4001::254/64 secondary
#exit

```



Note on UP2, IP can be 40.40.40.454, this is physical IP address specific to that UP.

L2 Monitoring:

```

config
context ingress
bfd-protocol
bfd multihop-peer 209.165.200.228 interval 50 min_rx 50 multiplier 20
bfd multihop-peer 209.165.200.229 interval 50 min_rx 50 multiplier 20
bfd multihop-peer 209.165.200.230 interval 50 min_rx 50 multiplier 20
#exit
interface TS_SecNet_v4 loopback
ip address 209.165.200.231 255.255.255.224
#exit
interface TS_SecNet_v4_1 loopback
ip address 209.165.200.232 255.255.255.224
#exit
interface TS_SecNet_v4_2 loopback
ip address 209.165.200.233 255.255.255.224
#exit
interface TS_Secnet_ingress
ip address 209.165.200.234 255.255.255.224
#exit
interface TS_Secnet_ingress1
ip address 209.165.200.235 255.255.255.224
#exit
interface TS_Secnet_ingress2
ip address 209.165.200.236 255.255.255.224
#exit

ip route static multihop bfd bfd1 209.165.200.231 209.165.200.228

ip route static multihop bfd bfd2 209.165.200.232 209.165.200.229

ip route static multihop bfd bfd3 209.165.200.233 209.165.200.230

ip route 209.165.200.228 255.255.255.224 209.165.200.237 TS_Secnet_ingress

```

```

ip route 209.165.200.229 255.255.255.224 209.165.200.238 TS_Secnet_ingress1
ip route 209.165.200.230 255.255.255.224 209.165.200.239 TS_Secnet_ingress2

#exit
end
config
context egress
bfd-protocol
bfd multihop-peer 209.165.200.231 interval 50 min_rx 50 multiplier 20
  bfd multihop-peer 209.165.200.232 interval 50 min_rx 50 multiplier 20
  bfd multihop-peer 209.165.200.233 interval 50 min_rx 50 multiplier 20

#exit
interface TS_SecNet_v4 loopback
  ip address 209.165.200.228 255.255.255.224
#exit
interface TS_SecNet_v4_1 loopback
  ip address 209.165.200.229 255.255.255.224
#exit
interface TS_SecNet_v4_2 loopback
  ip address 209.165.200.230 255.255.255.224
#exit
interface TS_Secnet_egress
  ip address 209.165.200.237 255.255.255.224
#exit
interface TS_Secnet_egress1
  ip address 209.165.200.238 255.255.255.224
#exit
interface TS_Secnet_egress2
  ip address 209.165.200.239 255.255.255.224
#exit
subscriber default
exit
aaa group default
#exit
ip route static multihop bfd bfd4 209.165.200.228 209.165.200.231
ip route static multihop bfd bfd5 209.165.200.229 209.165.200.232
ip route static multihop bfd bfd6 209.165.200.230 209.165.200.233
ip route 209.165.200.231 255.255.255.224 209.165.200.234 TS_Secnet_egress
ip route 209.165.200.232 255.255.255.224 209.165.200.235 TS_Secnet_egress1
ip route 209.165.200.233 255.255.255.224 209.165.200.236 TS_Secnet_egress2
#exit
end

```

One sample interface configuration to bind all interfaces to port and vlan.

```

port ethernet 1/11
  vlan 1608
    no shutdown
    bind interface TS_Secnet_ingress ingress
  #exit
  vlan 1609
    no shutdown
    bind interface TS_Secnet_ingress1 ingress
  #exit
  vlan 1610
    no shutdown
    bind interface TS_Secnet_ingress2 ingress
  #exit
#exit
port ethernet 1/13
  no shutdown

```



```

vlan 1608
  no shutdown
  bind interface TS_Secnet_egress egress
#exit
vlan 1609
  no shutdown
  bind interface TS_Secnet_egress1 egress
#exit
vlan 1610
  no shutdown
  bind interface TS_Secnet_egress2 egress
#exit

```

service schema configuration:

```

trigger-action tal
  up-service-chain sc_L3
#exit
trigger-action default
  up-service-chain default
#exit
trigger-condition tc1
  rule-name = udp
  rule-name = http-pkts
  rule-name = tcp
  rule-name = dynamic2
  multi-line-or all-lines
#exit
trigger-condition tc2
  rule-name = qci8
  rule-name = qci1
  multi-line-or all-lines
#exit
trigger-condition default
  any-match = TRUE
#exit
service-scheme scheme1
  trigger rule-match-change
    priority 1 trigger-condition tc1 trigger-action tal
    priority 2 trigger-condition tc2 trigger-action tal
  #exit
  trigger subs-scheme-received
    priority 1 trigger-condition default trigger-action default
  #exit
#exit
subs-class class1
  subs-scheme = gold
#exit
subscriber-base base1
  priority 1 subs-class class1 bind service-scheme scheme1
#exit

```

- **Host Specific configuration:** The following configurations is the part of the host specific configuration.
 - TS-bind IP configuration for each ACTIVE UP is the part of host specific configuration on RCM.

```

svc-type upinterface
  redundancy-group 1
  host Active1
  host 391 " context ISP1-UP"
  host 436 " interface ISP1_TO_PDN_v6 loopback"
  host 437 " ipv6 address 4000::106/128"
  host 438 " #exit"
  host 439 " interface ISP1_TO_PDN_v4 loopback"
  host 440 " ip address 209.165.200.240 255.255.255.224"

```

```

host 441 " #exit"
host 471 "ts-bind-ip up1 ipv4-address 209.165.200.240 ipv6-address 4000::106"
host 472 " exit"
host Active2
host 600 " context ISP1-UP"
host 601 " interface ISP1_TO_PDN_v6 loopback"
host 602 " ipv6 address 4000::107/128"
host 603 " #exit"
host 604 " interface ISP1_TO_PDN_v4 loopback"
host 605 " ip address 209.165.200.241 255.255.255.224"
host 606 " #exit"
host 607 "ts-bind-ip up2 ipv4-address 209.165.200.241 ipv6-address 4000::107"
host 608 " exit"

```



Note TS-bind IP is a loopback IP address. Its physical IP address is the part of Day-0 configuration.

- **Common configuration:** The following configuration is the part of the common configuration.
 - Traffic steering configuration (up-nsh format, up-appliance-group, and up-service-chain config).



Note Assuming that the ingress is configured with low vLAN, for uplink data flow, the packets are sent to SN at the ingress vLAN Id and received from SN at the egress vLAN Id. Similarly, for the downlink data flow, the packets are sent to SN at the egress vLAN Id and receive from the SN at the ingress vLAN Id.

```

nsh
  up-nsh-format L3-format
    tag-value 7 imsi encode
    tag-value 4 rating-group encode
    tag-value 1 stream-fp-md encode decode
    tag-value 2 reverse-stream-fp-md encode decode
    tag-value 76 subscriber-profile encode
    tag-value 3 secondary-srv-path-hdr encode
    tag-value 5 rat-type encode
    tag-value 51 mcc-mnc encode
    tag-value 255 apn encode
    tag-value 25 sgsn-address encode
  #exit

#exit
traffic-steering
up-appliance-group L2
steering-type l2-mpls-aware
min-active-instance 1
instance 1 ingress slot/port 1/12 vlan-id 1608 egress slot/port 1/13 vlan-id 1608
ingress-context ingress ip address 209.165.200.231egress-context egress ip address
209.165.200.228 load-capacity 100
instance 2 ingress slot/port 1/12 vlan-id 1609 egress slot/port 1/13 vlan-id 1609
ingress-context ingress ip address 209.165.200.232egress-context egress ip address
209.165.200.229 load-capacity 80
instance 3 ingress slot/port 1/12 vlan-id 1610 egress slot/port 1/13 vlan-id 1610
ingress-context ingress ip address 209.165.200.233egress-context egress ip address
209.165.200.230 load-capacity 90
exit
up-appliance-group L3_only

```

```

steering-type nsh-aware
up-nsh-format new
min-active-instance 1
instance 1 ip address 209.165.200.242 load-capacity 80
instance 2 ip address 209.165.200.243 load-capacity 90
#exit

up-service-chain sc_L3
  sfp-id 1 direction uplink up-appliance-group L2 instance 1 up-appliance-group
L3_only instance 2
  sfp-id 2 direction downlink up-appliance-group L3_only instance 2 up-appliance-group
L2 instance 1
  sfp-id 10 direction uplink up-appliance-group L2 instance 2 up-appliance-group
L3_only instance 2
  sfp-id 11 direction downlink up-appliance-group L3_only instance 2
up-appliance-group L2 instance 2
  sfp-id 12 direction uplink up-appliance-group L2 instance 3 up-appliance-group
L3_only instance 2
  sfp-id 13 direction downlink up-appliance-group L3_only instance 2
up-appliance-group L2 instance 3
  sfp-id 14 direction uplink up-appliance-group L2 instance 1 up-appliance-group
L3_only instance 1
  sfp-id 15 direction downlink up-appliance-group L3_only instance 1
up-appliance-group L2 instance 1
  sfp-id 16 direction uplink up-appliance-group L2 instance 2 up-appliance-group
L3_only instance 1
  sfp-id 17 direction downlink up-appliance-group L3_only instance 1
up-appliance-group L2 instance 2
  sfp-id 18 direction uplink up-appliance-group L2 instance 3 up-appliance-group
L3_only instance 1
  sfp-id 19 direction downlink up-appliance-group L3_only instance 1
up-appliance-group L2 instance 3
#exit
up-service-chain default
sfp-id 200 direction uplink up-appliance-group L3_only instance 1
sfp-id 201 direction downlink up-appliance-group L3_only instance 1
sfp-id 202 direction uplink up-appliance-group L3_only instance 2
sfp-id 203 direction downlink up-appliance-group L3_only instance 2
#exit
commit
exit

```

Show CLI for Verification

Following are the show CLIs for User Plane and RCM:

- User Plane: **Show srp checkpoints stats/ Show srp checkpoints stats debug-info**

```
laas-setup# show srp checkpoint statistics | grep UPLANE_TRAFFIC_STEERING_INFO
```

- RCM : **under rcm checkpoint manager**

```
"numTSInfo": 0
```

Monitoring and Troubleshooting—Standalone Mode

This section describes how to monitor and troubleshoot this feature.

Show Commands for Control Plane

This section describes the available show command to monitor this feature on CP.

show active-charging sessions full all



Note *TS Subscription Scheme Name*: Displays the subscription scheme that must be applied from the service-scheme configured under the active-charging-service. This active-charging-service is received from PCRF over the Gx interface.

Show Commands for User Plane

This section describes the available show commands to monitor this feature on UP.

Show Commands for Configuration

This section describes the available show commands to check configuration for the feature.

- **show user-plane-service traffic-steering up-service-chain all**
- **show user-plane-service traffic-steering up-service-chain name** *up-service-chain name*
- **show user-plane-service traffic-steering up-service-chain sfp-id** *sfp-id*

Show Commands for Data Statistics

This section describes the available show commands to check data statistics related to the feature.

- **show user-plane-service inline-services traffic-steering statistics up-service-chain all v**
- **show user-plane-service inline-services traffic-steering statistics up-service-chain all**
- **show user-plane-service inline-services traffic-steering statistics up-service-chain sfp-id** *sfp-id*
- **show user-plane-service inline-services traffic-steering statistics up-appliance-group all verbose**
- **show user-plane-service inline-services traffic-steering statistics up-appliance-group name** *appliance group name*
- **show user-plane-service inline-services traffic-steering statistics up-appliance-group name** *appliance group name instance appliance instance*

Show Commands to Check the Service Chain and SFP Association for TS:

This section describes the available show commands to check the service chain and SFP association.

- **show subscriber user-plane-only flows**
- **show subscribers user-plane-only callid** *<call-id>* **flows**

Show Commands for OAM Statistics

This section describes the available show commands to check OAM statistics related to the feature.

- **show user-plane-service inline-services traffic-steering oam all**
- **show user-plane-service inline-services traffic-steering oam summary**

- **show user-plane-service inline-services traffic-steering oam l3-steering summary**
- **show user-plane-service inline-services traffic-steering oam l3-steering monitors** *<ip address>*
- **show user-plane-service inline-services traffic-steering oam l3-steering monitors all**
- **show user-plane-service inline-services traffic-steering oam l3-steering monitors up-appliance-group** *<name>*
- **show user-plane-service inline-services traffic-steering oam l2-steering monitors all**
- **show user-plane-service inline-services traffic-steering oam l2-steering monitors up-appliance-group** *<name>*
- **show user-plane-service inline-services traffic-steering oam l2-steering summary**
- **clear user-plane-service traffic-steering oam statistics**
- **clear user-plane-service traffic-steering oam l3-steering statistics**

Currently BFD doesn't provide an API to clear session stats, so the following traffic-steering OAM clear command is extended to include l2-steering stats.

- clear user-plane-service traffic-steering
 - OAM - Clears OAM
 - statistics - Clears the User-Plane Traffic-steering Statistics
- clear user-plane-service traffic-steering OAM
 - L3-steering - Clear L3-steering OAM
 - statistics - Clears OAM statistics

Show Configuration Command

The following configuration is a snippet of a sample **show configuration** command for this feature.

```
nsh
  up-nsh-format format4
    tag-value 250 imsi encode
    tag-value 66 msisdn encode
    tag-value 4 rating-group encode
    tag-value 1 stream-fp-md encode decode
    tag-value 2 reverse-stream-fp-md encode decode
    tag-value 76 subscriber-profile encode
    tag-value 3 secondary-srv-path-hdr encode
    tag-value 5 rat-type encode
    tag-value 51 mcc-mnc encode
    tag-value 255 apn encode
    tag-value 25 sgsn-address encode
  #exit
traffic-steering
  up-service-chain L3
    sfp-id 65535 direction uplink up-appliance-group L3 instance 1
    sfp-id 65536 direction downlink up-appliance-group L3 instance 2
    sfp-id 65537 direction downlink up-appliance-group L3 instance 1
    sfp-id 65538 direction uplink up-appliance-group L3 instance 2
  #exit
```

```

up-service-chain sc_L3
  sfp-id 9 direction uplink up-appliance-group L2 instance 1 up-appliance-group L3
instance 1
  sfp-id 10 direction downlink up-appliance-group L3 instance 1 up-appliance-group L2
instance 1
  sfp-id 11 direction uplink up-appliance-group L2 instance 2 up-appliance-group L3
instance 1
  sfp-id 12 direction downlink up-appliance-group L3 instance 1 up-appliance-group L2
instance 2
  sfp-id 13 direction uplink up-appliance-group L2 instance 1 up-appliance-group L3
instance 2
  sfp-id 14 direction downlink up-appliance-group L3 instance 2 up-appliance-group L2
instance 1
  sfp-id 15 direction uplink up-appliance-group L2 instance 2 up-appliance-group L3
instance 2
  sfp-id 16 direction downlink up-appliance-group L3 instance 2 up-appliance-group L2
instance 2
  sfp-id 17 direction uplink up-appliance-group L2 instance 3 up-appliance-group L3
instance 1
  sfp-id 18 direction downlink up-appliance-group L3 instance 1 up-appliance-group L2
instance 3
  sfp-id 19 direction uplink up-appliance-group L2 instance 4 up-appliance-group L3
instance 1
  sfp-id 20 direction downlink up-appliance-group L3 instance 1 up-appliance-group L2
instance 4
  sfp-id 21 direction uplink up-appliance-group L2 instance 3 up-appliance-group L3
instance 2
  sfp-id 22 direction downlink up-appliance-group L3 instance 2 up-appliance-group L2
instance 3
  sfp-id 23 direction uplink up-appliance-group L2 instance 4 up-appliance-group L3
instance 2
  sfp-id 24 direction downlink up-appliance-group L3 instance 2 up-appliance-group L2
instance 4
#exit
up-appliance-group L3
  steering-type nsh-aware
  up-nsh-format format4
  min-active-instance 1
  instance 1 ip address 209.165.200.225
  instance 2 ip address 4001::3
#exit
up-appliance-group L2
  steering-type l2-mpls-aware
  min-active-instance 1
  instance 1 ingress slot/port 1/13 vlan-id 2136 egress slot/port 1/12 vlan-id 2136
ingress-context ingress ip address 4101::1 egress-context egress ip address 4101::2
load-capacity 100
  instance 2 ingress slot/port 1/13 vlan-id 2137 egress slot/port 1/12 vlan-id 2137
ingress-context ingress ip address 4201::1 egress-context egress ip address 4201::2
load-capacity 60
  instance 3 ingress slot/port 1/13 vlan-id 2138 egress slot/port 1/12 vlan-id 2138
ingress-context ingress ip address 4301::1 egress-context egress ip address 4301::2
load-capacity 20
  instance 4 ingress slot/port 1/13 vlan-id 2139 egress slot/port 1/12 vlan-id 2139
ingress-context ingress ip address 4401::1 egress-context egress ip address 4401::2
load-capacity 100
#exit
#exit
ts-bind-ip nshsrcip ipv4-address 209.165.200.226 ipv6-address 4001::106
#exit
context egress
bfd-protocol
  bfd multihop-peer 4101::1 interval 50 min_rx 50 multiplier 20
  bfd multihop-peer 4201::1 interval 50 min_rx 50 multiplier 20

```

```
    bfd multihop-peer 4301::1 interval 50 min_rx 50 multiplier 20
    bfd multihop-peer 4401::1 interval 50 min_rx 50 multiplier 20
#exit
interface ts_egress1
    ipv6 address 4101::2/64
    ip mtu 1600
#exit
interface ts_egress2
    ipv6 address 4201::2/64
    ip mtu 1600
#exit
interface ts_egress3
    ipv6 address 4301::2/64
    ip mtu 1600
#exit
interface ts_egress4
    ipv6 address 4401::2/64
    ip mtu 1600
#exit
subscriber default
exit
aaa group default
#exit
gtpv group default
#exit
ipv6 route static multihop bfd bfd1 4101::2 4101::1
ipv6 route static multihop bfd bfd2 4201::2 4201::1
ipv6 route static multihop bfd bfd3 4301::2 4301::1
ipv6 route static multihop bfd bfd4 4401::2 4401::1
ip igmp profile default
#exit
#exit
context ingress
    bfd-protocol
        bfd multihop-peer 4101::2 interval 50 min_rx 50 multiplier 20
        bfd multihop-peer 4201::2 interval 50 min_rx 50 multiplier 20
        bfd multihop-peer 4301::2 interval 50 min_rx 50 multiplier 20
        bfd multihop-peer 4401::2 interval 50 min_rx 50 multiplier 20
    #exit
    interface ts_ingress1
        ipv6 address 4101::1/64
        ip mtu 1600
    #exit
    interface ts_ingress2
        ipv6 address 4201::1/64
        ip mtu 1600
    #exit
    interface ts_ingress3
        ipv6 address 4301::1/64
        ip mtu 1600
    #exit
    interface ts_ingress4
        ipv6 address 4401::1/64
        ip mtu 1600
    #exit
    subscriber default
    exit
    aaa group default
    #exit
    gtpv group default
    #exit
    ipv6 route static multihop bfd bfd1 4101::1 4101::2
    ipv6 route static multihop bfd bfd2 4201::1 4201::2
    ipv6 route static multihop bfd bfd3 4301::1 4301::2
```

```

    ipv6 route static multihop bfd bfd4 4401::1 4401::2
    ip igmp profile default
    #exit
#exit
context ISP1-UP
ip access-list IPV4ACL
    redirect css service ACS any
    permit any
#exit
ipv6 access-list IPV6ACL
    redirect css service ACS any
    permit any
interface TO-ISP12
    ipv6 address 4001::106/64
    ip address 209.165.200.226 255.255.255.224 secondary
    ip mtu 2000
#exit
    port ethernet 1/12
    no shutdown
    vlan 2135
        no shutdown
        bind interface TO-ISP12 ISP1-UP
    #exit
    vlan 2136
        bind interface ts_egress1 egress
    #exit
    vlan 2137
        no shutdown
        bind interface ts_egress2 egress
    #exit
    vlan 2138
        no shutdown
        bind interface ts_egress3 egress
    #exit
    vlan 2139
        no shutdown
        bind interface ts_egress4 egress
    #exit
#exit
port ethernet 1/13
    no shutdown
    vlan 2137
        no shutdown
        bind interface ts_ingress2 ingress
    #exit
    vlan 2138
        no shutdown
        bind interface ts_ingress3 ingress
    #exit
    vlan 2139
        no shutdown
        bind interface ts_ingress4 ingress
    #exit
    vlan 2136
        no shutdown
        bind interface ts_ingress1 ingress
    #exit
#exit

```

Show Command for User Plane 1:1 Redundancy

show srp checkpoint statistics | grep ts-sfp

```
call-recovery-uplane-internal-audit-ts-sfp-failure: 0
```

Show Commands for SFP availability

```
show user-plane traffic-steering up-service-chain <all> <name> <sfp-id>
```

SNMP Traps

The following SNMP Traps are added in support of this feature:

- UPlaneTsMisConfig : When there is no SFP that is associated with an appliance group.
- UPlaneTsNoSelectedSfp : When an SFP selection is not possible.
- UPlaneTsServiceChainOrApplianceDown : When a service chain or an application node becomes unavailable. The service chain is unavailable when the minimum instance of application group becomes unavailable.
- UPlaneTsServiceChainOrApplianceUp : When the node status of appliance is updated because the service chain or application node instance becomes available.

Bulk Statistics

Up-service-chain Schema

Variable Name	Data Type	Counter Type	Description
up-svc-chain-name	String	Info	Name of up service chain
up-svc-chain-status	Int32	Info	Status of up service chain
up-svc-chain-load-status	Int32	Gauge	Load status of up service chain
up-svc-chain-sfp-stickness-miss-count	Int32	Counter	SFP stickiness miss count of up service chain
up-svc-chain-sfp-not-selected-count	Int32	Counter	SFP not selected count of up service chain
up-svc-chain-associated-calls	Int32	Gauge	Associated calls of up service chain
up-svc-chain-associated-flows	Int32	Gauge	Associated flows of up service chain
up-svc-chain-total-uplink-pkts	Int64	Counter	Total Uplink packets of up service chain
up-svc-chain-total-uplink-bytes	Int64	Counter	Total Uplink bytes of up service chain
up-svc-chain-total-downlink-pkts	Int64	Counter	Total Downlink packets of up service chain
up-svc-chain-total-downlink-bytes	Int64	Counter	Total Downlink bytes of up service chain

Up-appliance-group Schema

Variable Name	Data Type	Counter Type	Description
up-appl-group-name	String	Info	Name of up Appliance Group
up-appl-group-status	Int32	Info	Status of up appliance group
up-appl-group-load-status	Int32	Gauge	Load status of up appliance group
up-appl-group-node-down-count	Int32	Counter	Node down count of up appliance group
up-appl-group-associated-sfps	Int32	Gauge	Associated sfps of up appliance group
up-appl-group-num-times-loaded-state	Int32	Counter	Number of times node down state of up appliance group
up-appl-group-total-uplink-pkts	Int64	Counter	Total Uplink packets of up appliance group
up-appl-group-total-uplink-bytes	Int64	Counter	Total Uplink bytes of up appliance group
up-appl-group-total-downlink-pkts	Int64	Counter	Total Downlink packets of up appliance group
up-appl-group-total-downlink-bytes	Int64	Counter	Total Downlink bytes of up appliance group

The following CLI command is a sample bulkstats configuration for the feature.

```

config
  bulkstats collection
  bulkstats mode
  file 1
  up-service-chain schema TS format "\nup-service-chain-name = %up-svc-chain-name%
\nup-service-chain-status=%up-svc-chain-status%\nup-service-chain-load-status =
%up-svc-chain-load-status%\nup-service-chain-associated-calls =
%up-svc-chain-associated-calls%\nup-service-chain-associated-flows =
%up-svc-chain-associated-flows%\nup-service-chain-total-uplink-pkts =
%up-svc-chain-total-uplink-pkts%\nup-service-chain-total-uplink-bytes =
%up-svc-chain-total-uplink-bytes%\nup-service-chain-total-downlink-pkts =
%up-svc-chain-total-downlink-pkts%\nup-service-chain-total-total-downlink-bytes
= %up-svc-chain-total-downlink-bytes%\n\n"

```

Feature Description—Sandwich Mode

The Sandwich Mode caters to the NSH-based Traffic Steering (TS) approach to provide the metadata needed by the service function appliance's Forwarding Engine (FE) nodes.

The Sandwich Mode solution leverages the Cisco Nexus 9000 Series NX-OS Intelligent Traffic Director (ITD) in the Cisco USP instance. For more details about ITD, refer the *Cisco Nexus 9000 Series NX-OS Intelligent Traffic Director Configuration Guide*.

Architecture—Sandwich Mode

The following figure illustrates the integration of an external service function appliance with Cisco's SAEGW-U (User Plane).

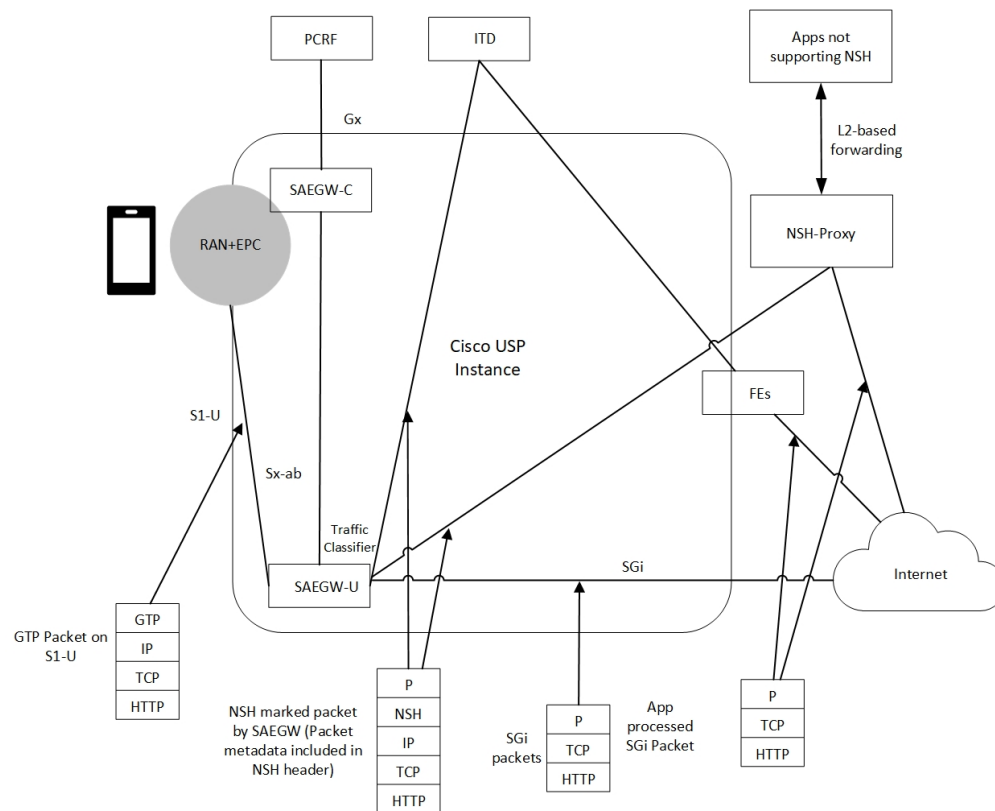

The Sandwich Mode solution includes the following functionality:

- SAEGW-U adds the relevant NSH-Based-Metadata onto the relevant packets exiting the Gi path only in the Uplink direction.
- The ITD, running in Sandwich Mode may load-balance these packets (based on source-IP) to the FEs.
- SAEGW-U doesn't perform any health checks toward the FEs or aware of its existence.
- The ITD node may maintain the “stickiness” at a session level. The ITD does so by looking at the NSH-Outer-IP-SRC-Header.
- In the Uplink direction, the source IP is the "UE-IP" (Copy of Inner IP header). The destination IP is the "server-IP-internet".
- In the Downlink direction, there's no NSH Header and the packet straight away goes from the Internet into the FEs. At SAEGW-U, the source IP is the "Server-IP", and the destination IP is the "UE-IP".
- SAEGW-U performs the traffic classification and selects the service chain for a given flow.
- Service chain at SAEGW-U can include more than one appliance, and the steering functions can handle these appliances.
- SAEGW-U encodes only the NSH Header on Uplink packets.
- SAEGW-U copies the source IP details directly from the original UE-IP Header. SAEGW-U uses NSH Port 6633 for outer header SRC and DEST Port. The destination IP is the Appliance IP (as configured).
- On receiving Downlink packets with NSH header, the SAEGW-U drops such packets.

- SAEGW-U doesn't perform any health checks for the FEs or the ITD. The SAEGW-U treats the ITD as always available.
- SAEGW-U encodes all Uplink packets (qualified by the service function appliance) towards ITD with NSH Base Header, Service Headers, and Context Headers (with Metadata).
- TS App works only in one mode (either Sandwich mode or Standalone mode) at a time.

**Note**

- For Sandwich mode, the **require tsmon** CLI command must not be configured.
- Changing from Sandwich to Standalone mode and conversely, requires a reboot.

How it Works—Sandwich Mode

Packet Flows in Sandwich Mode

Uplink Packets

The following figure illustrates the Uplink packet flow.

Uplink Packet Flow (single NSH IP for MSP traffic)

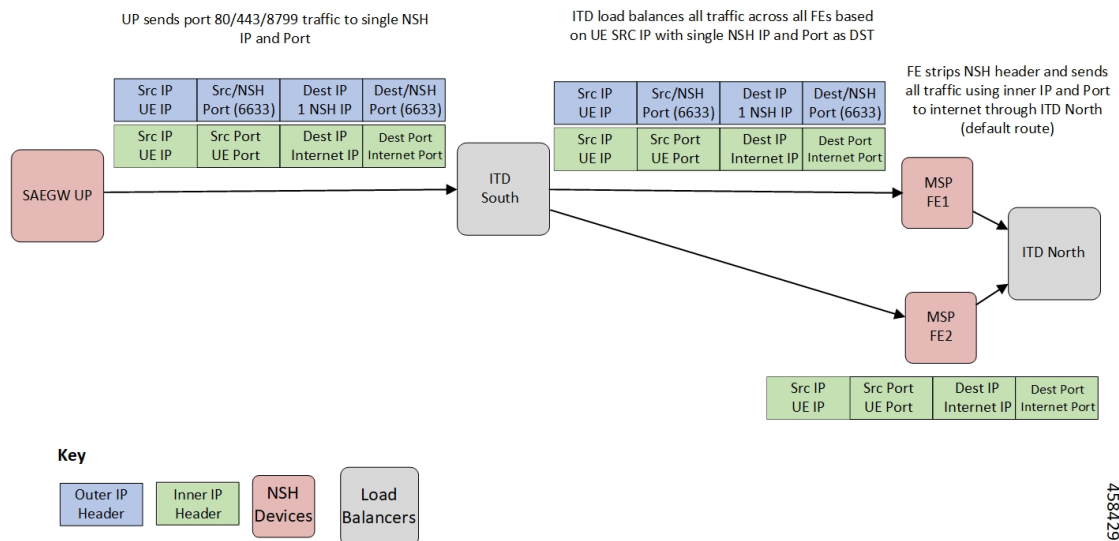

The following describes the packet flow:

1. GTP-U packet arrives at SAEGW-U. It decapsulates the GTP header and identifies the subscriber for the flow.

2. SAEGW-U performs traffic classification and associates a service chain for the flow. The SAEGW-U is configured to associate a service chain containing the service function appliance (ITD), with traffic classified depending on TCP/UDP/HTTP/HTTPS.
3. SAEGW-U looks up for NSH format associated with the service chain for encoding the parameters in the NSH variable header to be sent to the service function appliance.

The following is an example of NSH Header with SFP selected for the Uplink packet is 200.

```
*****NSH Base Header*****
      Version: 0
      OAM Bit: 0
      Length: 4
      MD Type: 2
      Next Protocol: 1

*****NSH Service Header*****
      Service Path Identifier: 200
      Service Index: 1

*****Start NSH Context Header*****
      TLV Type: <MSISDN tag configured in UP>
      TLV Len: 15
      TLV Value: 123456789012340 (unencrypted msisdn)

      TLV Type: <MCCMNC tag configured in UP>
      TLV Len: 6
      TLV Value: 404122 (mcc-mnc value)

      TLV Type: <RAT TYPE tag configured in UP>
      TLV Len: 1
      TLV Value: 3 (rat type value)

      TLV Type: <APN tag configured in UP>
      TLV Len: 64
      TLV Value: APN1 (apn value)

      TLV Type: <Sub Profile tag configured in UP>
      TLV Len: 32
      TLV Value: Profile-1 (Sub Profile name)

      TLV Type: <SGSN addr tag configured in UP>
      TLV Len: 4
      TLV Value: 169090600 (SGSN Addr(in network byte order))

*****End NSH Context Header*****
```

Downlink Packets

The following figure illustrates the Downlink packet flow.

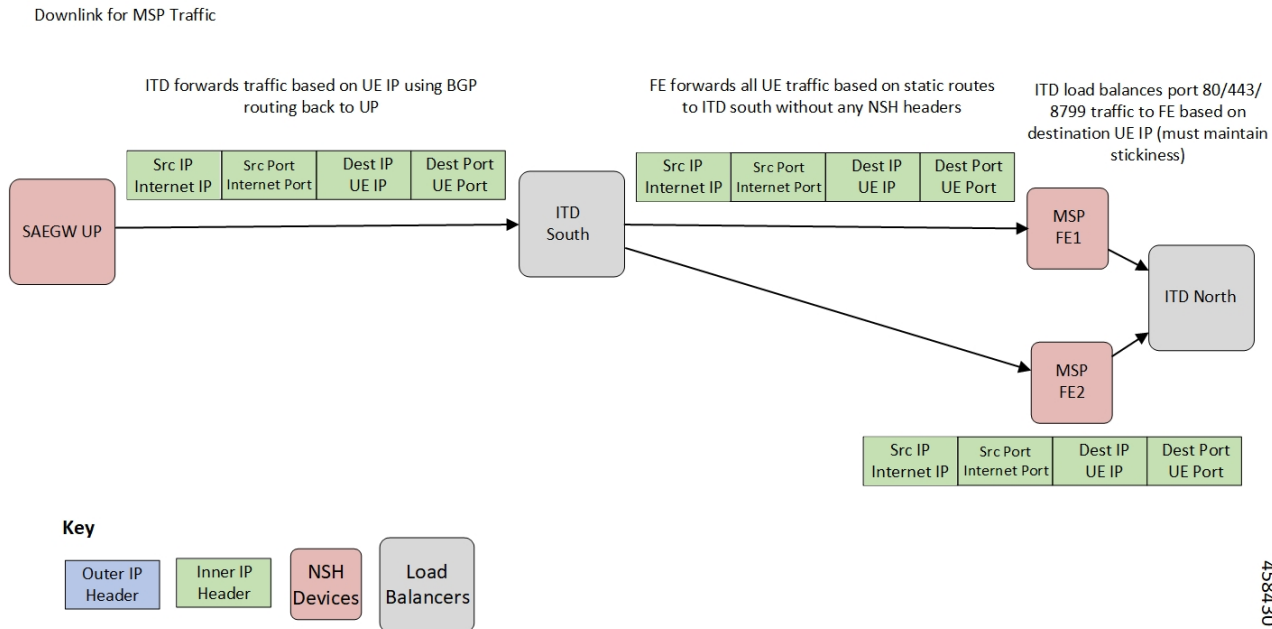

The following describes the packet flow:

1. Packets flow directly from internet server to the FEs. The FE processes the packets and sends it to the SAEGW-U.
The SRC IP/Port is the server IP/Port and the DEST IP/Port is the UE IP/Port.
2. The SAEGW-U processes the packet, and if there are more service function appliances in the service chain, sends the packet for further processing. If the service chaining is complete, the packet is sent to normal Downlink packet processing path for Rule matching/classification and charging.
3. The SAEGW-U encapsulates the packet with GTP-U header and sends it across to the UE.



Note Downlink packets must not be NSH encoded. Otherwise, SAEGW-U will drop all such packets.

TCP and UDP Traffic

Uplink Traffic

- All TCP and UDP traffic qualified for steering towards the appliance is treated alike.
- UL packets are steered to the appliance with configured NSH context header elements. The NSH Service header is encoded with SI=1. Therefore, further to SI deduction and with SI=0, packet is sent over the Gi interface.
- The outer headers SRC IP is the same as the inner headers SRC IP (that is, UE SRC IP).
- The outer headers SRC Port is NSH port 6633.
- The outer headers DST IP is the configured Appliance IP.
- The outer headers DST PORT is the NSH port 6633.

Downlink Traffic

Downlink packets are received from FEs through ITD and therefore, processed as normal IP packet without being steered toward the FEs.

- UL packet received at the SAEGW-U is classified and based on the configured policy associated with the appropriate SFC.
- The SAEGW-U performs the SFP selection based on the service and load availability of the appliance instances and selected steer. The Uplink traffic is NSH (IP-UDP) encapsulated and steered on the selected SFP with the context header populated as deemed necessary.
- The NSH appliance on receiving the NSH packet, processes the IP packet (and possibly the context header), and sends the packet over the Gi interface.
- Downlink packet is sent by the destination server over the Gi interface to the SAEGW-U.

Service-Scheme Selection for Traffic Steering

You can select service-scheme in one of the following two ways:

1. Gx/PCRF:

PCRF enables Traffic Steering through the following AVPs:

```
[V] Services:
[V] Service-Feature:
[V] Service-Feature-Type: TS (4)
[V] Service-Feature-Status: ENABLE (1)
[V] Service-Feature-Rule-Install:
[V] Service-Feature-Rule-Definition:
[V] Service-Feature-Rule-Status: ENABLE (1)
[V] Subscription-Scheme: gold
[V] Profile-Name: L3_profile
```

TS Profile and TS Subscriber Scheme are then sent to User Plane through Sx messaging:

```
SUBSCRIBER PARAMS:
...
...
...
TS-Profile: L3_profile
TS-Subscriber-Scheme: gold
```

For Gx/PCRF based Traffic Steering, the **trigger subs-scheme-received** CLI command is required in the service-scheme configuration.

2. Service-scheme framework (without Gx/PCRF AVPs):

Traffic Steering can be enabled without Subscription-scheme AVP from PCRF.

The **trigger sess-setup** CLI command is required with trigger-action pointing to the **up-service-chain**. The following is an example configuration:

```
service-scheme scheme1
trigger sess-setup
priority 1 trigger-condition subs-scheme-check trigger-action ta2
exit

trigger-condition subs-scheme-check
any-match = TRUE
```

```

exit

trigger-action tal
  up-service-chain SN-L3_profile

exit

```

Default Service Chain

For a TS-enabled subscriber, the following conditions can cause unavailability of service chain (APP1+APP2) for certain traffic:

- There's no suitable policy configured for certain flows which would select the APP1+APP2 service chain.
- APP1+APP2 service chain was selected, however, APP1 instances went down below the minimum instance threshold. In such case, the APP1+APP2 service chain won't be available.
- APP1+APP2 service chain was selected, however, no SFP could be selected.

Under such cases of service chain unavailability, the flows fall back to the configured default service chain and ensuring APP2 service treatment to the flows.

If a default service chain isn't configured, it leads to the traffic being sent out nonsteered.

For TS-enabled through Gx/PCRF, the default service chain is defined through **trigger subs-scheme-received**.

For TS-enabled through service scheme framework without Gx/PCRF AVPs, the default service chain is defined through **trigger sess-setup**.

SFP Selection

For service chains with only NSH-based appliance:

For Downlink packets, there's no NSH appliance and so, there's no SFP.

For service chains with a mix of L2 and NSH-based appliances:

Any SFP is selected based on L2 "stickiness". Same NSH-based appliance is present, and always available for SFP selection.

For Downlink packets, the SFP selection is based only on L2 appliance.

There's no SFP selection based on Load availability of NSH-based appliance. The NSH/appliance is considered as always-available.

Limitations and Restrictions

The following are the known limitation/restrictions of the feature:

- Changing from Standalone mode to Sandwich mode and vice versa, requires a reload and configuration change.
- When Traffic Steering is enabled from PCRF or locally using the service-scheme framework, then Traffic Steering can't be disabled on that session.
- For multi appliance service chain (L2 and L3 steering), the SFPs for V4 and V6 traffic are different. However, both SFPs maintains the L2 appliances MSISDN based stickiness.

Configuring NSH Traffic Steering—Sandwich Mode

This section provides information about the CLI commands available to configure NSH Traffic Steering—Sandwich Mode in both CP and UP

CP Configuration

Perform the following steps to configure the CP:

1. Configure the Active Charging Service configuration.

The following is an example configuration:

```
configure
  active-charging service ACS
  policy-control services-framework

  trigger-action ta1
    up-service-chain sn-L3-sc <<<< (This should match the up-service-chain configured
on UP)
  exit

  trigger-action ta2
    up-service-chain L3-sc <<<< (This should match the up-service-chain configured
on UP)
  exit

  trigger-condition tc1
    rule-name = rule1 <<<<<< (This can be static/predef/gor/dynamic rules)
    rule-name = rule2
    multi-line-or
  exit

  trigger-condition tc2
    any-match = TRUE
  exit

  service-scheme schemel
    trigger rule-match-change
      priority 1 trigger-condition tc1 trigger-action ta1
    exit
    trigger subs-scheme-received <<<<<< (For default service chain selection)
      priority 1 trigger-condition tc2 trigger-action ta2
    exit

  subs-class class1
    subs-scheme = gold <<<<<<< (This name should match the subscription-scheme AVP
value received from PCRF over Gx)
  exit

  subscriber-base basel
    priority 1 subs-class class1 bind service-scheme schemel
  exit
end
```

2. Traffic steering AVPs are currently supported with the Diameter dictionary custom44. The Diameter dictionary enables CP to properly decode the TS-related AVPs when they are received over the Gx interface and sent in Sx message to UP.

The following is an example configuration to configure the Dictionary in CP.

```

configure
context ISP1
  ims-auth-service IMGx
  policy-control
  diameter dictionary dpca-custom44
exit
end

```

The following are the sample values for TS-related AVPs received over Gx in CCA-I/CCA-U/RAR.

```

[V] Services:
[V] Service-Feature:
[V] Service-Feature-Type: TS (4)
[V] Service-Feature-Status: ENABLE (1)
[V] Service-Feature-Rule-Install:
[V] Service-Feature-Rule-Definition:
[V] Service-Feature-Rule-Status: ENABLE (1)
[V] Subscription-Scheme: gold
[V] Profile-Name: L3

```

UP Configuration

Perform the following steps in same sequence to configure the UP:

1. Add the interface in the contexts which will be used to send data toward the Service chain appliances.

The following is an example configuration:

```

configure
context ISP1-UP
  interface ts_ingress
  ip address 209.165.200.225 255.255.255.224
  ipv6 address 4101::1/64 secondary
exit
end

configure
context ISP2-UP
  interface ts_egress
  ip address 209.165.200.225 255.255.255.224
  ipv6 address 4101::2/64 secondary
exit
end

```

2. Bind these newly-added interfaces to the physical ports of the UP.

The following is an example configuration:

```

configure
port ethernet 1/11
  vlan 1240
  no shutdown
  bind interface ts_ingress ISP1-UP
exit
exit
port ethernet 1/12
  vlan 1240
  no shutdown
  bind interface ts_egress ISP2-UP
exit
exit
end

```

3. Add the TS-related configuration in the UP.

The following is an example configuration:

```
configure
  ts-bind-ip IP_UP01 ue-src-ip ipv4-address 209.165.200.225      <<<< See Notes below

  nsh
    up-nsh-format nfo
      tag-value 1  apn encode
      tag-value 2  imsi encode
      tag-value 3  mcc-mnc encode
      tag-value 4  msisdn encode
      tag-value 5  rat-type encode
      tag-value 10 rating-group encode
      tag-value 11 sgsn-address encode
      tag-value 12 subscriber-profile encode
    exit
  exit

  traffic-steering
    up-service-chain L3
      sfp-id 1 direction uplink up-appliance-group L3 instance 1
    exit

    up-service-chain sn_L3
      sfp-id 3  direction uplink    up-appliance-group L2 instance 1 up-appliance-group
L3 instance 1
      sfp-id 4  direction downlink  up-appliance-group L2 instance 1
      sfp-id 5  direction uplink    up-appliance-group L2 instance 2 up-appliance-group
L3 instance 1
      sfp-id 6  direction downlink  up-appliance-group L2 instance 2
      sfp-id 7  direction uplink    up-appliance-group L2 instance 3 up-appliance-group
L3 instance 3
      sfp-id 8  direction downlink  up-appliance-group L2 instance 3
      sfp-id 9  direction uplink    up-appliance-group L2 instance 4 up-appliance-group
L3 instance 3
      sfp-id 10 direction downlink  up-appliance-group L2 instance 4

    exit
    up-appliance-group L3
      steering-type nsh-aware
      up-nsh-format nfo
      min-active-instance 1
      instance 1 ip address 40.40.40.3
    exit
    up-appliance-group L2
      steering-type l2-mps-aware
      min-active-instance 1
      instance 1 ingress slot/port 1/13 vlan-id 2136 egress slot/port 1/12 vlan-id 2136
      ingress-context ingress ip address 4101::1 egress-context egress ip address 4101::2
      instance 2 ingress slot/port 1/13 vlan-id 2137 egress slot/port 1/12 vlan-id 2137
      ingress-context ingress ip address 4201::1 egress-context egress ip address 4201::2
      instance 3 ingress slot/port 1/13 vlan-id 2138 egress slot/port 1/12 vlan-id 2138
      ingress-context ingress ip address 4301::1 egress-context egress ip address 4301::2
      instance 4 ingress slot/port 1/13 vlan-id 2139 egress slot/port 1/12 vlan-id 2139
      ingress-context ingress ip address 4401::1 egress-context egress ip address 4401::2
    exit
  exit
```

NOTES:

- **ts-bind-ip name ue-src-ip { ipv4-address ipv4_address | ipv6-address ipv6_address }**: Specifies the IP address of the UP interface from which packet is sent out toward ITD.

4. Verify the above configurations using **show configuration** CLI command. Then, execute the **commit** CLI command for the configurations to be effective.

```
configure
  traffic-steering
    commit
end
```

Configuring Post Processing Ruledef in Both Standalone and Sandwich Mode

up-service-chain trigger action is used with trigger condition in the configuration of post processing a ruledef in the rulebase for steering the traffic. A single post processing ruledef is defined with port numbers for HTTP, HTTPS and other protocols even when there are multiple charging ruledefs. This single post processing ruledef name is matched in the trigger condition which is used in traffic steering.

Use the following configuration to configure post processing of ruledef for steering traffic:

```
configure
  active-charging service service_name
    rulebase rulebase_name
      post-processing priority priority_number ruledef ruledef_name
  charging-action charging_action_name
  end
```

Use the following configuration to configure the trigger condition in post processing ruledef:

```
configure
  trigger-condition trigger_condition_name
    rule-name rule_name
    post-processing-rule-name post_processing_rule_name
  end
```

Configuring BFD Instance Id Using Interface Name in UP Appliance Group

During traffic steering, in the **up-appliance-group**, the BFD instance id is configured using the interface name and IP configuration.

Use the following configuration to configure BFD instance id for steering traffic:

```
configure
  traffic-steering
    up-appliance-group up_appliance_group_name
      steering-type steering_type
        instance instance_id ingress slot/port slot_or_port_number vlan-id vlan_id
        egress slot/port slot_or_port_number vlan-id vlan_id ingress-context ingress
        interface-name interface_name egress-context egress interface-name interface_name
      end
```

**Note**

- For any given L2 **up-appliance-group**, the BFD instance id is configured using the IP address or the **interface-name** for the particular **ingress** or **egress** using the corresponding interface names.
- Once the **up-appliance-group** configuration is complete for BFD monitoring using the **interface-name**, the BFD registration takes upto five minutes to complete.
- Once the BFD registration is successful, the IP address and the **interface-name** will be available in the **show user-plane traffic-steering up-appliance-group all** output.
- In case the IP address changes for any **interface-name** used in the **up-appliance-group** with BFD monitoring, then the **up-appliance-group** must be reconfigured.

Monitoring and Troubleshooting the NSH Traffic Steering—Sandwich Mode

This section provides information about the CLI commands available for monitoring and troubleshooting the feature.

For details about SNMP Traps, refer [SNMP Traps, on page 611](#) section of this chapter.

For details about Bulk Statistics, refer [Bulk Statistics, on page 611](#) section of this chapter.

Show Commands

This sections provides information about the show CLI commands that are available in support of the feature.

CP Commands

Use the following show CLI command in CP to monitor and troubleshoot the feature: **show active-charging sessions full all**

TS Subscription Scheme Name: Displays the subscription scheme that must be applied from the service-scheme configured under the active-charging-service. This active-charging-service is received from PCRF over the Gx interface.

UP Commands

Use the following show CLI commands in UP to monitor and troubleshoot the feature.

- Traffic Steering configuration check
 - **show user-plane-service traffic-steering up-service-chain all**
 - **show user-plane-service traffic-steering up-service-chain name** *up_service_chain_name*
 - **show user-plane-service traffic-steering up-service-chain sfp-id** *sfp_id*
 - **show user-plane traffic-steering up-appliance-group name** *name* **instance-id** *id*
 - **show user-plane traffic-steering up-appliance-group name** *name*

- **show user-plane traffic-steering up-appliance-group all**
- **show user-plane traffic-steering up-service-chain name** *name*
- **show user-plane traffic-steering up-service-chain sfp-id** *id*
- **show user-plane traffic-steering up-service-chain all**
- Traffic Steering statistics
 - **show user-plane-service inline-services traffic-steering statistics up-service-chain all verbose**
 - **show user-plane-service inline-services traffic-steering statistics up-service-chain all**
 - **show user-plane-service inline-services traffic-steering statistics up-service-chain sfp-id** *sfp_id*
 - **show user-plane-service inline-services traffic-steering statistics up-appliance-group name** *appliance_group_name*
 - **show user-plane-service inline-services traffic-steering statistics up-appliance-group name** *appliance_group_name* **instance** *appliance instance*
 - **show user-plane-service statistics trigger-action all**
- Service chain and SFP association
 - **show subscriber user-plane-only flows**
 - **show subscribers user-plane-only callid** *call_id* **flows**

show user-plane traffic-steering up-appliance-group all

Use the following show CLI command to monitor and troubleshoot the feature.

- **show in interface-name out interface-name**



CHAPTER 62

Password Encryption Improvement

- [Revision History, on page 625](#)
- [Feature Description, on page 625](#)
- [How it Works, on page 625](#)
- [Configuring Encryption Password, on page 627](#)

Revision History

Revision Details	Release
First introduced.	21.27.4

Feature Description

The configuration files in CUPS contain many commands for various levels of sensitive information ranging from non-sensitive to highly confidential information. Sensitive information must be protected from unauthorized access from admins or users. There are numerous methods for securing sensitive data which are listed below:

- Symmetrical Encryption.
- Asymmetrical Encryption.
- One-way Hashing.

How it Works

Symmetrical encryption is used to secure sensitive information present in the configuration files, such as remote TACACS+ passwords for client authentication, LI configuration, passwords, SSH key, SNMP community strings, and so on. Sometimes, sensitive information in plain text format is forwarded to the remote servers in CUPS. One example is when the CUPS system acts as the TACACS+ client where a password authentication is required to access the remote TACACS+ server. Once the sensitive information is saved after the one-way hashing process, the system cannot decode or reverse the hash value to obtain the plain text.

CUPS uses symmetrical encryption to address this issue, by allowing the password to be hashed with random salt.

The plain text password is hashed by the system using the **PBKDF2** hash algorithm as follows:

- System generates 16 bytes of random salt from the /dev/urandom device file.
- The number of iterations in **PBKDF2** is calculated as follows:
 - 10000 rounds as base value.
 - Additional rounds based on random salt.
 - The result (hash value) of length 64 bytes.

The hashed password is saved during system configuration process. The plain text password that is entered by the user is then converted to a hash value based on the same salt for comparison the authentication phase.



Note The password hash value is encrypted in such a way as to minimize and avoid any further changes in the existing CLI.

Symmetrical Encryption Occurrences

For various types of data, there are many symmetrical encryption occurrences in CUPS.

Encryption of Smaller and Generic Sensitive Data (fewer than 512 bytes)

CUPS handles the encryption of smaller and generic sensitive data which is lesser than 512 bytes in length.

P2P Library License Expiry to a Persistent File on Flash

The feature P2P license control the P2P libraries with expiry date. P2P licenses have an expiry time which controls the loading of valid P2P libraries. License expiry time from the P2P license is stored in a file for future reference.

Encryption of Long Data (larger than 512 bytes)

Larger size binary text is split into smaller chunks of 512 bytes each. Each of these smaller chunks is then encrypted separately and concatenated together as strings.

SSH Key of CUPS as Client (mgmt interface)

CUPS also acts as SSH client for some transactions. Once the client SSH key gets generated, it is encrypted during configuration and saved. Subsequent system reboots decrypts and uses this SSH key.

Server SSH Key of CUPS (per context)

CUPS acts as SSH server for incoming login connection requests of administrators. SSH key of SSH server gets generated once and encrypted in the configuration and saved. Subsequent system reboots decrypt it and uses the SSH key.

RSA Private Keys of the System

CUPS provides configuration support for RSA certificates and private key in the configuration mode. These private keys are encrypted using symmetrical encryption in the configuration.

Configuring Encryption Password

Encryption of System Level and Admin Passwords

The encryption of system level and admin passwords is explained below.

Admin Passwords in Saved Configuration

System administrators account passwords appear as "***" values in the **show configuration o/p** command. Whereas the passwords are encrypted using the **save configuration o/p** command.

Tech Support Password

Tech support passwords for support and debugging purposes are available in CUPS. Use the following configuration for configuring the tech support password.

```
configure
  tech-support test-commands [encrypted] password
end
```

Connected Apps Session Password in QvPC-SI Systems

Use the following configuration for configuring the session password.

```
sess-passwd encrypted password
```

ACS Billing

Use the following configuration for configuring the RADIUS user password.

```
cca radius user-password encrypted password password
```

IMS CSCF NPBD Bind IP System Id

Use the following configuration for configuring the IMS CSCF NPBD Bind IP System ID.

```
IMS CSCF NPBD Bind IP System-id sys_id id id encrypted password password
```

SNMP Community String

Use the following configuration for configuring the SNMP Community String.

```
snmp community encrypted password
```

TACACS+ Client Password

Use the following configuration for configuring the TACACS+ Client Password.

```
server priority ip-address ip_address password password
```

BFD Multi-hop Peer Authentication

Use the following configuration for configuring the BFD multihop peer authentication.

```
bfd multihop-peer peer_name authentication authentication encrypted password  
password
```



CHAPTER 63

PDI Optimization

- [Feature Summary and Revision History, on page 629](#)
- [Feature Description, on page 629](#)
- [How It Works, on page 630](#)
- [Configuring the PDI Optimization Feature, on page 635](#)
- [PDI Optimization OAM Support, on page 636](#)

Feature Summary and Revision History

Revision History



Note Revision history details are not provided for features introduced before release 21.24.

Revision Details	Release
First introduced	Pre 21.24

Feature Description

The Packet Detection Information (PDI) Optimization feature allows the optimization of PFCP signaling, through Sx Establishment and Sx Modification messages, between the Control Plane and the User Plane function. Without PDI Optimization, the following common parameters are repeated in the PDI of all Packet Detection Rules (PDRs), for a given bearer, resulting in an unwanted increase in signaling between Control Plane and User Plane:

- Local F-TEID
- Network Instance
- UE IP address

- The PDI Optimization is achieved by consolidating the common parameters, in the PDI of the PDRs, into a single container that is called the Traffic Endpoint (Traffic Endpoint ID). The consolidated parameters from multiple PDRs are then referred to the Traffic Endpoint.
- The PDI Optimization is a CLI-controlled feature, and supported over the Sxa, Sxb, Sxc, Sxab, and N4 interfaces.

Relationships

The PDI Optimization feature is a prerequisite for the following features:

- GTP-U Error Indication Support on User Plane.
- Sx Bulkstats
- CUPS Bulkstats Support

How It Works

The Traffic Endpoint ID is unique within a PFCP session. When a PDI refers to a Traffic Endpoint, the parameters that are in the Traffic Endpoint is not provided in the PDI once again. The Control Plane function updates the Traffic Endpoint whenever applicable.

If a Traffic Endpoint is updated, all the PDRs that refer to this Traffic Endpoint in the User Plane function uses the updated information.

If the F-TEID allocation is performed in the User Plane function, the User Plane function allocates and stores the F-TEID associated to the Traffic Endpoint. When the User Plane function provides the allocated F-TEID to the Control Plane function in the PFCP Session Establishment response or PFCP Session Modification response message, the Control Plane function updates the Traffic Endpoint information that is stored in the Control Plane function with the received F-TEID.

The Control Plane function uses the Traffic Endpoint ID created in a different PFCP message only after getting the confirmation from the User Plane function of the Traffic Endpoint ID creation.

If the Control Plane function deletes a Traffic Endpoint, the User Plane function deletes all the PDRs that refer to the Traffic Endpoint that was deleted by Control Plane function. For Evolved Packet Core (EPC), the Remove Traffic Endpoint IE is used to delete a bearer for which multiple PDRs exist (with the same Traffic Endpoint ID).

The Traffic Endpoints is used as a mechanism to identify the bearers uniquely for a given Sx session on the User Plane. This is achieved with the help of Traffic Endpoint IDs that are associated with the PDRs of a bearer.

PDI Optimization Changes on Control Plane

A new container, called Traffic Endpoint, is supported to carry the repeated PDI information of a given bearer. Each Traffic Endpoint is associated with a Traffic Endpoint ID. This ID is unique for a given Sx Session.

A new IE, Create Traffic Endpoint IE, is supported as part of Sx Establishment Request.

Following are the new IEs supported as part of Sx Modification Request:

- Create Traffic Endpoint IE
- Update Traffic Endpoint IE
- Remove Traffic Endpoint IE

Create PDR supports a new IE, Traffic Endpoint ID, that identifies either the ingress or the egress Traffic Endpoint of a bearer to which this PDR is associated.

A new IE, Created Traffic Endpoint IE, is supported as part of Sx Establishment Response and Sx Modification Response message.

Create Traffic Endpoint IE

Following are the IEs in a Create Traffic Endpoint IE that are supported for a Pure-P call:

- Traffic Endpoint ID
- Local F-TEID
- Network instance
- UE IP address

Following are the IEs in a Create Traffic Endpoint IE that are supported for a Pure-S call:

- Traffic Endpoint ID
- Local F-TEID

NOTE: The Network instance and UE IP address IEs are currently not supported for a Pure-S call.

For a Collapsed call, Sxa Traffic Endpoints has IEs that are relevant to S-GW and Sxb Traffic Endpoints has IEs that are relevant to P-GW.

In addition to the 3GPP standards defined IEs, a private IE called "Bearer Info IE", is added to the Create Traffic Endpoint which includes:

- QCI of the bearer being created.
- ARP of the bearer being created.
- Charging ID of the bearer being created.

For a Pure-S call, there are two Traffic Endpoints that are created for each bearer of that PDN:

1. Create Traffic Endpoint for Ingress Traffic Endpoint, that is sent for the ingress F-TEID and referred by ingress S-GW PDR of the bearer.
2. Create Traffic Endpoint for Egress Traffic Endpoint, that is sent for the egress F-TEID and referred by egress S-GW PDR of the bearer.

For a Pure-S call, a bearer is uniquely identified on the User Plane that is based on Ingress and Egress Traffic Endpoint IDs of the bearer. The Traffic Endpoints also store the QCI, ARP, and Charging ID of the bearer.

For a Pure-P call, only one Traffic Endpoint is created for each bearer of that PDN. Create Traffic Endpoint for Ingress Traffic Endpoint, that is sent for ingress F-TEID and referred by ingress PDRs of the bearer. There is no separate egress Traffic Endpoint that is created for a Pure-P call as no Tunnel Endpoint ID is allocated on the P-GW egress. The same Traffic Endpoint is referred by both ingress and egress PDRs of a bearer. A

bearer is uniquely identified on the User Plane that is based on the Traffic Endpoint ID of the bearer. The Traffic Endpoint also stores the QCI, ARP, and Charging ID of the bearer.

For a Collapsed call, there are two Traffic Endpoints that are created for the S-GW leg of the call for each bearer. So, two Create Traffic Endpoints are sent for Ingress and Egress. The Sxa PDRs refer to these traffic endpoints based on the direction (ingress or egress). Only one Traffic Endpoint is created for the P-GW leg of the call for each bearer. The same Traffic Endpoint ID is referred by all Sxb PDRs of the bearer. For P-GW, Create Traffic Endpoint is sent for the ingress. The Traffic Endpoint IDs of Sxa and Sxb PDRs identify the bearer.

Created Traffic Endpoint IE

This IE is present in Sx Establishment/Sx Modification Response to inform Control Plane about the F-TEIDs that were locally allocated by the User Planes for the various Traffic Endpoints that were created.

Following are the IEs in a Created Traffic Endpoint IE:

- Traffic Endpoint ID
- Local FTEID

The information that is received in Created Traffic Endpoint IE is processed by the Control Plane, and the F-TEIDs that are allocated by the User Plane are stored in the Control Plane for ingress and egress accordingly.

Update Traffic Endpoint IE

This IE is present in Sx Modification Request to update the Traffic Endpoint information on the User Plane.

Following are the IEs in an Update Traffic Endpoint IE:

- Traffic Endpoint ID
- Local FTEID
- Network Instance
- UE IP address
- In addition to the 3GPP standards defined IEs, a private IE called "Bearer Info IE", is added to the Create Traffic Endpoint which includes:
 - QCI of the bearer
 - ARP of the bearer
 - Charging ID of the bearer

NOTE: Currently, the Update Traffic Endpoint IE supports only the update of Private IE extensions, such as the Bearer Info IE. There are no use-cases wherein update of other information, such as Local FTEID, Network Instance, UE IP address, is required.

When the QCI/ARP of a particular bearer EPS-Bearer Identity (EBI) is modified, then the modified QCI/ARP along with the Charging ID is communicated to the User Plane with the help of Update Traffic Endpoint ID. A given Traffic Endpoint ID can be updated only if it was successfully created on the User Plane.

Remove Traffic Endpoint IE

This IE is present in Sx Modification Request to remove a traffic endpoint. Traffic Endpoint ID is included in the Remove Traffic Endpoint IE. A given Traffic Endpoint ID can be removed only if it is successfully created on the User Plane.

For Pure-S, Pure-P, and Collapsed call, when a bearer is deleted on the Control Plane, the Traffic Endpoints that are associated with the bearer are removed with Remove Traffic Endpoints. There is no explicit requirement to send Remove PDRs and Remove FARs on that bearer.

On the User Plane, for a Pure-S call, Remove Traffic Endpoints deletes all the PDRs, FARs, and URRs of that bearer. For Pure-P and Collapsed call, Remove Traffic Endpoints deletes all the PDRs, FARs, QERs, and URRs of that bearer.

PDI Changes in Create PDR

When PDI Optimization is enabled for the PDN, then the Traffic Endpoint ID is set in the PDI field of all PDRs of the bearers of the PDN. The PDI fields, such as F-TEID, PDN Instance, UE IP address, and so on, are not supposed to be filled and so, these fields are validated in the User Plane and error messages are posted in case of any validation failures. This is applicable for all interfaces, such as Sxa, Sxb, Sxab, N4, and Sxc.

PDI Optimization Changes on User Plane

Handling of Create Traffic Endpoint

When a Create Traffic Endpoint is received, the contents of the IE are validated for correctness. If validation fails, then an error message is sent back to the Control Plane.

Validations fail in the following cases:

- Basic IE validation failures.
- Traffic Endpoint exists with this Traffic Endpoint ID.
- CH-bit not set in the F-TEID IE inside Traffic Endpoint.
- PDN Instance is not valid.
- UE IP address is not valid.

When a Create Traffic Endpoint is successfully processed, then a local F-TEID is allocated by the User Plane and it is associated with the Traffic Endpoint. The Created Traffic Endpoint is sent back to Control Plane for this Traffic Endpoint with the F-TEID information and Traffic Endpoint ID.

When a Create Traffic Endpoint list is processed on the User Plane in Sx Establishment Request, PDI optimization is enabled for the lifetime of the Sx Session which cannot be changed midway.

Handling of Update Traffic Endpoint

When an Update Traffic Endpoint is received, the contents of the IE are validated for correctness. If validation fails, then an error message is sent back to the Control Plane.

Validations fail in the following cases:

- Basic IE validation failures.

- Traffic Endpoint with its Traffic Endpoint ID does not exist.

NOTE: Currently, Update Traffic Endpoint updates only bearer information, such as QCI, ARP, and Charging ID on the User Plane. Update is not supported for any other Traffic Endpoint parameters.

Handling of Remove Traffic Endpoint

When a Remove Traffic Endpoint is received, the contents of the IE are validated for correctness. If validation fails, then an error message is sent back to the Control Plane.

Validations fail in the following cases:

- Basic IE validation failures.
- Traffic Endpoint with its Traffic Endpoint ID does not exist.

When a Remove Traffic Endpoint is received, the PDRs associated with the Traffic Endpoint, FARs associated with the PDR, QERs associated with the PDR, and URRs associated with PDR are also removed.

To remove a bearer, the Control Plane sends Remove Traffic Endpoints for the Traffic Endpoints that are associated with the bearer resulting in the cleanup of the bearer-associated data on the User Plane.

The Control Plane does not explicitly send any Remove PDRs, Remove FARS, Remove QERS, or Remove URRs for a bearer removal. However, if the Control Plane does send Remove PDRs, Remove FARS, Remove QERS, or Remove URRs with Remove Traffic Endpoints, the message is accepted and successfully processed.

Handling of Create PDR

When Sx Session has the PDI Optimization enabled, the Traffic Endpoint ID is set for Create PDR. If not, an error response is sent back to the Control Plane. The Create PDR validation fails in the following cases:

- Basic IE validation failures.
- Create PDR does not have Traffic Endpoint ID set in the PDI IE.
- Create PDR has valid F-TEID IE in PDI IE.
- Create PDR has valid PDN Instance IE in PDI IE.
- Create PDR has valid UE IP address IE in PDI IE.

For a Sx Session with PDI optimization disabled, the Create PDR is validated for various other fields. If Traffic Endpoint ID is valid in PDI, then an error response is sent back to the Control Plane as Traffic Endpoint ID should not be present for a Sx Session with the PDI optimization being disabled.

Session Recovery and ICSR

Control Plane

Session Recovery and ICSR are supported for the Traffic Endpoint IDs of all bearers of a PDN. The Traffic Endpoint IDs are recovered for all bearers of a given PDN. This support is provided for Pure-S, Pure-P, and Collapsed call. With this, PDI optimization enabled status for a PDN is also recovered. Full Checkpoint is used for check-pointing and recovery of the Traffic Endpoints IDs of bearers.

User Plane

Session Recovery and ICSR are supported for the Traffic Endpoints on the User Plane for all bearers. All the Traffic Endpoints, that are associated with a given Sx Session, are recovered. For a given Traffic Endpoint, the associated PDR list is also recovered. For a given PDR, the associated Traffic Endpoint ID is recovered.

Standards Compliance

The PDI Optimization feature complies with the following standard: 3GPP TS 29.244 V15.5.0 (Interface between the Control Plane and the User Plane Nodes).

Limitations

The PDI Optimization feature has the following limitations:

- The Network instance and UE IP address IEs are currently not supported for a Pure-S call.
- The Update Traffic Endpoint IE supports only the update of Private IE extensions, such as the Bearer Info IE. Update of other information, such as Local F-TEID, Network Instance, UE IP address, are not supported.
- The Update Traffic Endpoint updates only bearer information, such as QCI, ARP, and Charging ID on the User Plane. Update is not supported for any other Traffic Endpoint parameters.

Configuring the PDI Optimization Feature

This section describes how to configure the PDI Optimization feature.

Enabling PDI Optimization

Use the following CLI commands to enable the feature.

```
configure
  context context_name
    sx-service service_name
      [ no ] sx-protocol pdi-optimization
    end
```

NOTES:

- **no**: Disables PDI optimization.
- By default, the CLI command is disabled.
- PDI Optimization is enabled or disabled at PDN level. PDI Optimization is enabled for each PDN based on the configuration in sx-service. The PDN is PDI Optimization-enabled if the configuration is enabled while processing Sx Establishment Request on the Control Plane.
- Configuration changes will not have any effect on the PDN. The configuration that is applied while processing Sx Establishment Request will be maintained throughout the lifetime of the PDN. In a multi-PDN call, each PDN has the configuration applied while PDN is set up.

- On the User Plane, there is no separate configuration to determine whether the PDN has PDI Optimization-enabled. When Create Traffic Endpoint IE is received in Sx Establishment Request for a Sx session, then the Sx session is considered to have PDI Optimization-enabled throughout the lifetime of the session. This will not change dynamically midway, and validations are done accordingly. In case of any validation failures, Error Response is sent back to the Control Plane.
- When there are multiple Create Traffic Endpoint IEs with the same Traffic Endpoint ID, the first Create Traffic Endpoint IE is processed, and rest are ignored. The same behavior is applicable for Created Traffic Endpoint IE, Update Traffic Endpoint IE, and Remove Traffic Endpoint IE.

Verifying the PDI Optimization Feature Configuration

To verify if the PDI Optimization feature is enabled or disabled, use the **show sx-service all** CLI command. The output of this show command has been enhanced to display the following:

- SX PDI Optimisation: [Enabled/Disabled]

PDI Optimization OAM Support

This section describes operations, administration, and maintenance information for this feature.

Show Command Support

The following show CLI commands are available in support of PDI Optimization feature.

show subscribers user-plane-only callid <call_id> pdr all

The output of this CLI command has been enhanced to display the following field: Associated Create Traffic Endpoint-ID(s)

show subscribers user-plane-only callid <call_id> pdr full all

The output of this CLI command has been enhanced to display the following field:

- Create Traffic Endpoint-ID
 - Bearer QOS
 - QCI
 - ARP
 - Charging Id



CHAPTER 64

P-GW CDR in CUPS

- [Revision History](#), on page 637
- [Feature Description](#), on page 637
- [User Location Information in P-GW CDR](#), on page 638

Revision History



Note Revision history details are not provided for features introduced before release 21.24.

Revision Details	Release
First introduced	Pre 21.24

Feature Description

In CUPS architecture, support is added for P-GW CDR generation for custom24 GTPP dictionary.

The P-GW CDR is generated for the following procedures and scenarios:

- Default Bearer:
 - Volume/Time Limit
 - PCRF initiated Rule Base change
 - S-GW/PLMN change due to S1 Handover
 - ULI/Time Zone change
 - QoS change
 - UE/Network initiated session deletion
 - RAN-NAS cause code
 - Maximum change condition trigger

- Dedicated Bearer:
 - Volume/Time Limit
 - QoS change
 - Handover Procedure
 - ULI/Time Zone change
 - PCRF rule base change
 - UE/Network initiated Dedicated Bearer Deletion Procedure
 - RAN-NAS cause code



Note The correct volume is reported in CDRs when the context ID for Gi and billing context matches in both CP and UP. If the IDs do not match, the volume reported in CDRs will be zero.

Limitations

The aFRecordInformation is not supported in CUPS architecture.

User Location Information in P-GW CDR

The P-GW CDR contains the User Location Information (ULI) in the following two attribute fields:

- User Location Information (32)
- User Location Information (34-0-20)

As per the current behavior above two fields contain the “User Location information” in P-GW CDR. These fields are getting updated only when ULI-change trigger is enabled. If ULI-change trigger is not configured, the P-GW CDRs keeps the user location as it was reported in the initial CDR, even after the “Radio Access Technology” gets changed.

To overcome this issue, this feature was introduced, that even if “ULI-change trigger” is disabled, Every CDR contains the latest “User Location Information”. Functionality overview of this feature is as follows:

- This feature allows the P-GW CDRs to update User Location Information (32) and User Location Information (34-0-20) attributes with the latest User Location Information provided by the MME and S-GW.
- The implementation of the feature is through the different filler function specific to feature.
- To use this feature, customer/user requires to make the software changes at two places. First one is to update the CDR custom/customer’s dictionary ULI fields with the newly implemented filler functions. Current implementation is in the custom dictionary 38, as per requirement. Parallely, the support for the same dictionary need to be added under the MACRO: “ACS_CHK_DICT_SUPPORT_FOR_LATEST_ULI”.

If the dictionary with the new filler functions are used, it packs the latest ULI in case of the following events:

Events to send/generate partial PGW-CDR for a subscriber:

- When the number of QoS changes or tariff time changes reaches the configured maximum number of charging condition changes.
- Before this, service containers are added to the CDR for every change.
- Every x seconds configured using "interval x".
- Every x octets configured using "volume x" (up/down/total).
- Command gtpm interim now active-charging egcdr.
- Transferring the context to a new S-GW/SGSN (serving Node Change).
- Changing the access type within the same P-GW (RAT Change).

Events to send or generate the final P-GW CDR for a subscriber:

- Detach Request received from UE
- Delete bearer context request received from S-GW.
- Manual subscriber clearing
- Abnormal Releases such as path failures.

Sample Configuration

Following are the sample configurations:

```
Customer dictionary: custom38
Customer running configuration:
  gtpm group pwhdd
    gtpm attribute local-record-sequence-number
    gtpm attribute node-id-suffix PGW11
    no gtpm attribute twanuli
    gtpm dictionary custom38
    no gtpm trigger dcca
    no gtpm trigger service-idle-out
    no gtpm trigger serving-node-change-limit
    no gtpm trigger inter-plmn-sgsn-change
    no gtpm trigger qos-change
    no gtpm trigger ms-timezone-change
    gtpm trigger egcdr max-losdv
    no gtpm trigger uli-change
    gtpm egcdr lotdv-max-containers 1
    gtpm egcdr losdv-max-containers 1
    gtpm suppress-cdrs zero-volume-and-duration gcdrs egcdrs
    gtpm egcdr service-data-flow threshold interval 43200
    gtpm egcdr service-data-flow threshold volume total 104857600
    gtpm storage-server mode local
  gtpm storage-server local file purge-processed-files file-name-pattern

    ACQ* purge-interval 2880
  gtpm storage-server local file format custom3
  gtpm storage-server local file rotation volume mb 30
  gtpm storage-server local file rotation cdr-count 65000
  gtpm storage-server local file rotation time-interval 600
```

```
gtp storage-server local file name prefix PGW11_Laca  
#exit.
```



CHAPTER 65

P-GW Restart Notification

- [Revision History, on page 641](#)
- [Feature Description, on page 641](#)

Revision History



Note Revision history details are not provided for features introduced before release 21.24.

Revision Details	Release
First introduced	Pre 21.24

Feature Description

P-GW Restart notification (PRN) procedure is supported for UP communication over the Sx interface during P-GW path failure. The P-GW Restart Notification procedure optimizes the amount of signaling involved on the S11/S4 interface when a P-GW failure is detected.

PRN procedure is a standards-based procedure supported on S-GW to notify detection of P-GW failure to MME/S4-SGSN.

P-GW failure detection will be done at S-GW when it detects that the P-GW has restarted (based on restart counter received from the restarted P-GW) or when it detects that P-GW has failed but not restarted (based on path failure detection).

When an S-GW detects that a peer P-GW has restarted, it locally deletes all PDN connection and bearer contexts associated with the failed P-GW and notifies the MME through P-GW Restart Notification.

The S-GW, in the echo request/response on S11/S4 interface, indicates that the P-GW Restart Notification procedure is supported.

P-GW Restart Notification Procedure is an optional procedure and is invoked only if both the peers, MME/S4-SGSN and S-GW, support it.

In the absence of this procedure, S-GW will initiate the Delete procedure to clean up all the PDNs anchored at that failed P-GW, which can lead to flooding of GTP messages on S11/S4 if there are multiple PDNs using that S-GW and P-GW.

The following figure illustrates the PRN flow during a path failure.

In CUPS, when a path failure is detected:

IMAGE HERE

- On detecting S5 pathfailure S-GW initiates PRN processing if S-GW and MME supports the PRN feature.
- For a path failed session, if S-GW has not sent a PRN message to MME then it will send PRN message once per MME.
- For path failed session, the S-GW CP sends a Sx Modify with FAR Action = DROP.
- On receiving Sx Modify Response, the S-GW CP sends Sx Delete Request to UP.

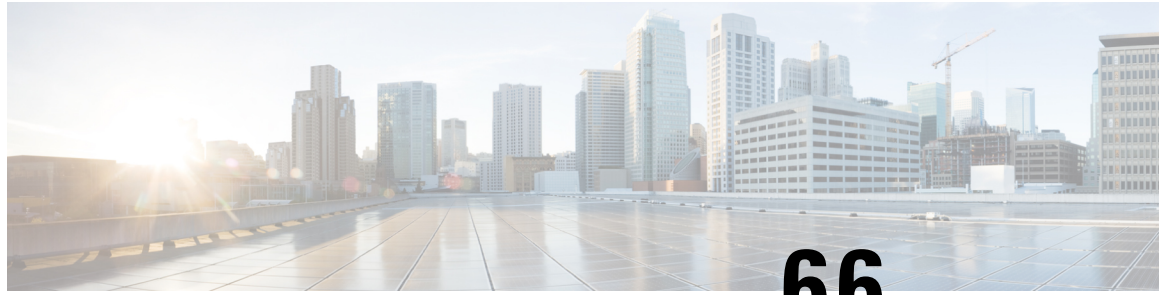

CHAPTER 66

Post Processing Interaction for DCCA

- [Feature Description, on page 643](#)

Feature Description

The following diagram explains about the packet processing.

Figure 43: Post Processing Interaction for DCCA

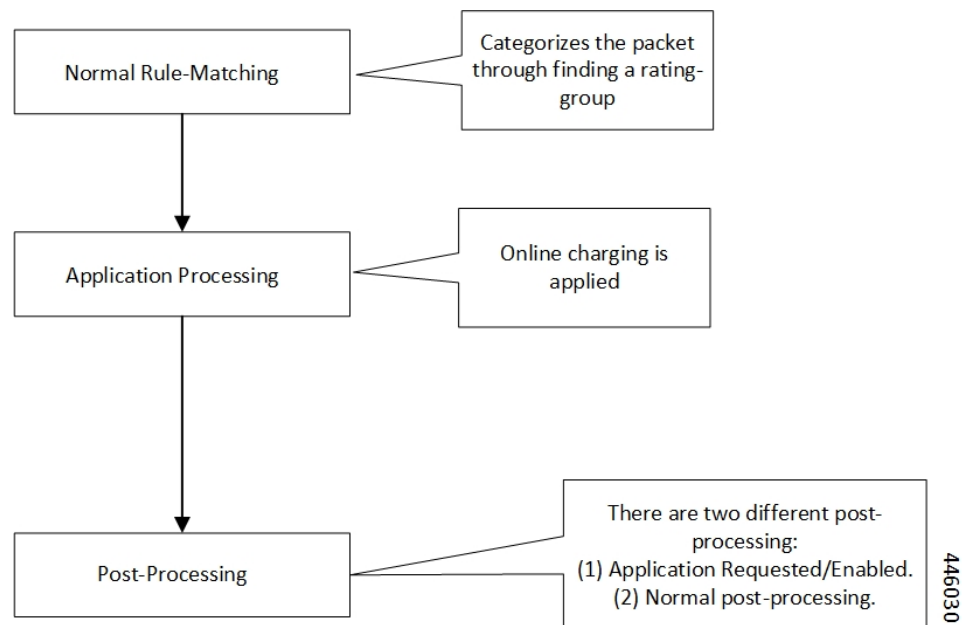

Normal Rule Matching

In this phase, A comparison happens between the incoming packet against the configured rules in the box. This rule matching process is nothing but categorizing the packet. Use the following CLIs for the Rule Matching configuration in the box.

```
action priority <priority-number> ruledef <ruledef-name>  
charging-action <charging-action>
```

Based on priority order, the Rule Matching happens against the packet. The first rule that matches categorizes the packet.

The corresponding charging-action applies to the packet. If the charging-action configuration contains “cca charging credit”, then it triggers the online charging, for which the packet moves to the DCCA application.

Application Processing

Once the packet reaches the DCCA Application, it checks the quota for the packet (rating-group/content-id) and makes the necessary processing. When there are no more credits for that rating-group, the Final-Unit-Actions takes place on the packet. If no-credit is present in that rating-group, DCCA can also blacklist the rating-group. When the application is blacklisting, the packet gets marked for Discard/Drop. The packet is in the disposition-action to inform the ACS mgr. If the quota is present, the packet goes for forwarding. The DCCA application can alternatively populate the post processing rules/filter list and mark the packet for postprocessing. The postprocessing happens when the OCS has requested for applying the filter-ids or filter-rules along with the Final-Unit-Indication AVPs. Once the DCCA application processing completes on the packet, it goes back to the ACS mgr.

Post Processing

When the packet returns from the application, the ACS MGR, sees the disposition action value set by the DCCA Application. If it's marked for discard, it gets discarded.

- **Application Requested Post-Processing:** If the disposition-action applies for PP_RESTRICTION_RULE or PP_FILTER_ID, it tries to get the corresponding restrict-rules-list or restrict-filter-id-list for the content-id/rating-group. It applies the postprocessing. The packet doesn't attempt for the below-post-processing (General Post-Processing).
 - **ACS_CONTROL_PP_RESTRICTION_RULE:** This disposition action applies, when the DCCA activates Restriction-Filter-Rules sent by OCS, inside the Final-Unit-Indication Grouped-AVP, as per RFC 4006. The Restriction-Filter-Rules are applicable in “restriction_list”, inside the “fui_restrict_access”.
 - **ACS_CONTROL_PP_FILTER_ID:** This disposition action applies, when the DCCA activates the Filter-Ids, the OCS inside the Final-Unit-Indication grouped-AVP, as per RFC4006. The Filter-Ids are nothing but the rule def names, and are applicable in “filter_id_list”, inside the “fui_restrict_access”

DCCA Application can set both the disposition actions. Disposition-action is nothing but a bitmask.

These postprocessing restrict rules or postprocessing filter ids, that came from OCS and enabled/activated by DCCA Application. This rule is rating-group specific rules. The rule-matches happen in the order in which the OCS sends.

For each acs_sub_sess, there's a list of “dcca_mscc_fui_restrict_access_t”, indexed on “service_id & rating_group”. For each of this combination, the preceding type structure exists. This “dcca_mscc_fui_restrict_access_t” structure contains the “filter_id_list” & “fui_restrict_access” lists. This structure gets empty by default. The DCCA application can fill it when it activates the corresponding post processing filtering for that service-id + rating-group.

- **General Post Processing:** If it's forward, the post processing starts. During the post processing, the packet gets matched against the configured post processing rules in the boxer.

Configure the post processing rules in boxer using the following CLIs:

```

Post processing priority <priority-number> ruledef <ruledef-name>
charging-action <charging-action-name>

```

These post processing rules get matched against the packet in the order of the priority-number.

Limit Reached Post Processing

In addition to the preceding two disposition action values, there's one more value for limit-reached scenarios, it's ACS_CONTROL_PP_LIMIT_REACHED. Here the limit-reached indicates that the user quota-limit is over. When the user quota is over, the packets get dropped by default, by application, and no post processing applies. The feature is to add control on this limit-reached scenario, where post processing configuration happens, even for this quota exhausted scenario.

A configurable option is available for enabling the post processing for limit-reached/quota-exhausted packets. Use the following CLI for this configuration:

```

configure
  active-charging service service_name
    rulebase rulebase_name
      post-processing policy { always | not-for-dynamic-discard }
    end

```

The option “not-for-dynamic-discard” is the default option. This option indicates that the post processing doesn't apply for the limit-reached/quota-exhausted scenarios.

In case of the “post processing policy always” CLI, the post processing rules applies for the limit-reached/quota-exhausted scenarios. The “ACS_CONTROL_PP_LIMIT_REACHED” value in the disposition action is to communicate about this behavior. If there are post processing priority-based rules, it checks for any redirection rules, else discards the packets by default. No other post processing actions like forward, next-hop, X-header-insertion applies on these limit-reached packets.

Configuring Post Processing

The post processing rule def with the limit-reached case have “cca quotoa-state = limit-reached” configured, along with the “rule-application post processing” option. This configuration is to indicate that this rule def is for the limit-reached scenario.

```

ruledef http_low
  http any-match = TRUE
  cca quota-state = limit-reached
  rule-application postprocessing
#exit

```

The corresponding charging-action has the “flow action redirect” configuration. Any other flow action values are invalid for the limit-reached scenario.

```

charging-action redirect
  flow action redirect-url http://webpages/index.html
#exit

```

Configure the post processing priority rules in the rule base in such a way that the limit reached post processing rules is of the high priority. So that the packets get matched first against the limit-reached rule def.

```

rulebase base1
  .....
  post processing priority 1 ruledef http_low charging-action redirect
#exit

```



CHAPTER 67

Priority Recovery Support for VoLTE Calls

- [Feature Summary and Revision History, on page 647](#)
- [Feature Description, on page 647](#)
- [How It Works, on page 647](#)
- [Call Flows, on page 649](#)
- [Configuration, on page 650](#)
- [Monitoring and Troubleshooting, on page 651](#)
- [Show Commands and Outputs, on page 651](#)

Feature Summary and Revision History



Note Revision history details are not provided for features introduced before release 21.24.

Revision Details	Release
First introduced	Pre 21.24

Feature Description

This feature helps to priorities the active and nonactive VoLTE calls over the normal calls. The priority is for the recovery of calls due to the failure of the User Plane.

Relationship

This feature is related to *VoLTE Support in CUPS*.

How It Works

There are two types of sessions in the User Plane:

- Normal Session

- Prioritized session

Prioritized session - The MP (message priority) bit set in PFCP header received from the Control Plane during the Sx Session establishment/modification request. The prioritized sessions take precedence in case of recovery. Normal calls recover only after the completion of the recovery of the prioritized calls.

The Control Plane sets the message priority (upper nibble of the 16th octet) in the PFCP header along with the MP (second bit of the first Octet). Currently for EMPS calls, Message Priority is 1. Similarly, message priority is 2 for VoLTE active calls and Message priority is 3 for VoLTE nonactive calls. Following figure describes the message priority in PFCP header format for the various calls.

	Bits							
Octets	8	7	6	5	4	3	2	1
1	Version			Spare	Spare	Spare	MP = 1	S=1
2	Message Type							
3	Message Length (1st Octet)							
4	Message Length (2nd Octet)							
5	Session Endpoint Identifier (1st Octet)							
6	Session Endpoint Identifier (2nd Octet)							
7	Session Endpoint Identifier (3rd Octet)							
8	Session Endpoint Identifier (4th Octet)							
9	Session Endpoint Identifier (5th Octet)							
10	Session Endpoint Identifier (6th Octet)							
11	Session Endpoint Identifier (7th Octet)							
12	Session Endpoint Identifier (8th Octet)							
13	Sequence Number (1st Octet)							
14	Sequence Number (2nd Octet)							
15	Sequence Number (3rd Octet)							
16	Message Priority = 1 EMPS/EMERGENCY = 2 for VoLTE active call = 3 for VoLTE nonactive				Spare			

On receipt of SX Session establish/modification request, the User Plane marks the session as prioritized session. The priority is based on nonzero (EMPS=1, VoLTE Active=2, VoLTE nonactive =3) value of the message priority filled in the PFCP header.

This feature supports the following aspects for the Priority Recovery of VoLTE calls.

On Control Plane: (P-GW, S-GW, SAE-GW, GGSN)

- VoLTE call configuration under APN

- Sets the MP priority Bit and Message Priority in the PFCP header of SX session establishment request
- Sets MP priority Bit and Message Priority in the PFCP header of SX session modification request

On User Plane:

- Checks the Message Priority of the PFCP header for the earlier messages
- If the message priority is nonzero, mark the session as priority session.
- These prioritized sessions are recovered before the nonprioritized sessions after SR /ICSR.

Call Flows

The following call flows explain about the:

- Session Establishment Handling
- Session Modification Handling

Session Establishment Handling Call Flow

The following call flow explains about the Session Establishment.

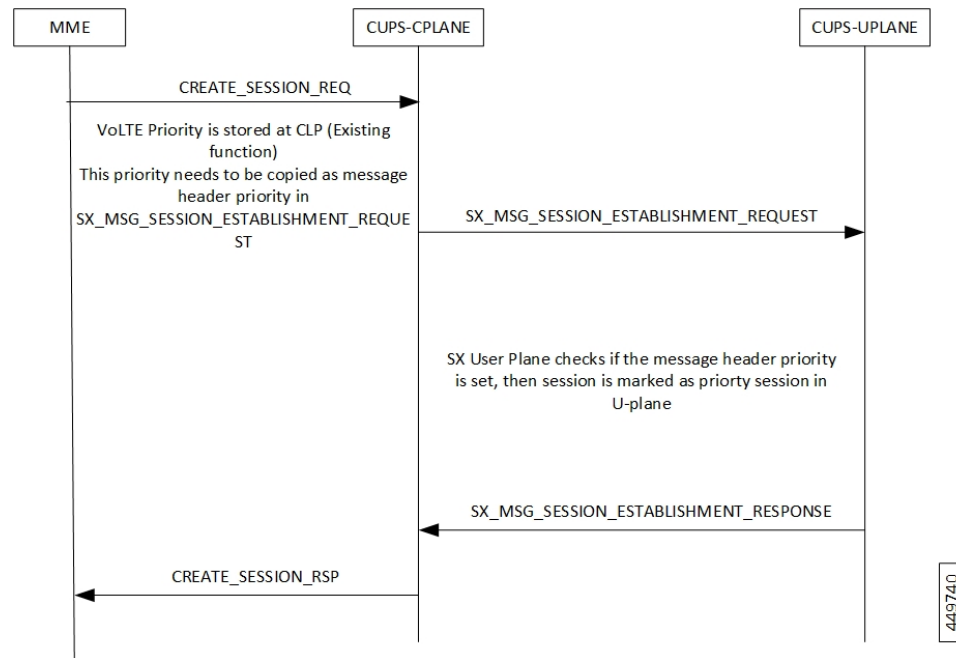

Session Modification Handling Call Flow

The following call flow explains about the Session Modification.

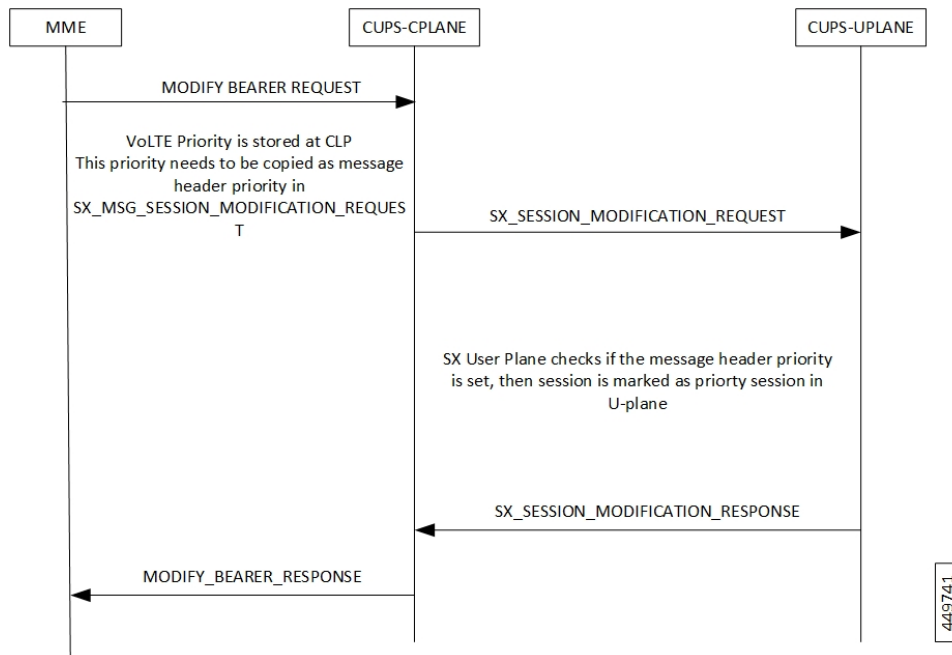

449741

Configuration

Following are the configurations for the Pure-P/Collapsed calls and Pure-S calls.

Configuring Pure-P or Collapsed Calls

Following are the configurations to mark the calls as VoLTE in Control Plane for Pure-P/Collapsed calls.

```

configure
    context ingress
    apn vrf.com
    qcil ims-media
end
  
```

Configuring Pure-S Calls

Following are the configurations to mark the calls as VoLTE in Control Plane for Pure-S/Collapsed calls.

```

configure
    apn profile apn_1
    qcil ims-media
configure
    operator-policy name intershat
    apn default-apn-profile apn_1
end
configure
    lte-policy
    subscriber-map map_name
    precedence 1 match-criteria all operator-policy-name intershat
end
  
```



```

configure
  context ingress
  sgw-service sa_sgw_service
  associate subscriber-map map_name
end

```

Monitoring and Troubleshooting

This section provides information on CLI commands that are available for monitoring and troubleshooting for priority recovery of VoLTE calls.

Show Commands and Outputs

This section provides information about show CLI commands that are available in support of priority recovery of VoLTE calls in User Plane.

show session subsystem facility sessmgr instance 1 debug-info

```

AAA TCP Connect Succeeded with      : 0      Retries
fetched_from_aaamgr                  : 1      pror_to_audit                : 1
passed_audit                          : 1      calls_recovered                  : 1
calls_recovered_by_tmr                 : 1      calls_recovered_by_med          : 0
priority_calls_recoverd_by_med         : 0      non_priority_calls_ignored_by_med: 0

```

show session subsystem facility aaamgr instance 1 debug-info

```

1 Current recovery archives 1 Current valid recovery records
1 Current valid priority recovery records

```



CHAPTER 68

QoS Group of Ruledefs Support

- [Revision History](#), on page 653
- [Feature Descriptions](#), on page 653
- [How It Works](#), on page 653
- [Monitoring and Troubleshooting](#), on page 656

Revision History



Note Revision history details are not provided for features introduced before release 21.24.

Revision Details	Release
First introduced	Pre 21.24

Feature Descriptions

QoS Group of Ruledefs is also called as QGR or SGQ. This feature enables fair usage policing for the subscriber.

How It Works

The following configuration primarily does Flow-Status and Bandwidth Limiting in hierarchical manner, first doing at matched Charging-Action and then at QoS-Group Level.

```
conf
active-charging service acs
  qos-group-of-ruledefs QGR1
    add-group-of-ruledef group
    add-ruledef http
  #exit
rulebase cisco
action priority 2 ruledef http charging-action standard
action priority 5 ruledef catchall charging-action standard
```

```
route priority 1 ruledef http-rule analyzer http
end
```

QoS Group QGR1 received over PCRF.

```
qos-group-rule-install
qgr-name QGR2
qgr-mon-key 1
qgr-flow-status 3
qgr-precedence 1
qgr-eqos-information
qgr-eqos-mbr 1000 2000
qgr-eqos-mbr-burst-size 1000 2000
qgr-eqos-mbr-limit-conform-action 1 -1 1 -1
qgr-eqos-mbr-limit-exceed-action 2 7 2 8
```

Data Path Enforcement

1. Packet matches ruledef 'http'.
2. QGR match is carried out to check if there is a QGR with the matched ruledef/group. Highest Priority QGR is returned. The ruledef/group can be static or predefined.
3. If QGR matches, then Flow-Action Enforcement which is first done at Charging-Action Level and then at QGR Level assuming Charging-Action has allowed the packet. If the packet is dropped, then QGR Level Flow Action Enforcement is skipped.
4. If Flow-Action at QGR allows the packet, then QER Limiting is enforced on a packet. If it is dropped at QGR, QER Limiting is skipped.
5. Likewise, QER Limiting is done stepwise, first at Charging-Action Level and then at the QGR subject to packet is allowed at Charging-Action.

Static Configuration Push to UPlane

- Static configuration pushed from CP to UP via the PFD mechanism in similar to ECS elements ruledef/charging-action/group-of-ruledefs.
- Show CLIs 'show user-plane-service qos-group-of-ruledefs all/name' displays the static configuration on UPlane.

QGR Params Push to UPlane

QGR is pushed along with Session Establishment and Modification Request.

QGR Name and Precedence is sent in a private IE. Flow-action, bandwidth parameters, and monitoring-key will create a new FAR, new QER, and new URR respectively.

Any changes to QGR dynamic parameters triggers an update to FAR/QER/URR.

This is sent in Session Establishment or Modification Request.

Private IE

```
Qos-Group-Of-Ruledef:
Name:
Operation: (0 - Add 1 - Modify 2 - Delete)
```

Precedence:
 FAR ID:
 URR ID:
 QER ID:

Table 50: FAR Format

FAR ID	Unique ID
Extended Apply Action	Private IE to include Flow-Action Allow as well Discard, Uplink, Discard Downlink, Terminate Flow.

Table 51: QER Format

QER ID	Unique ID
Maximum Bitrate	MBR of QGR in Kbps: UL MBR: DL MBR:
Burst Size	Private IE to include the Burst Size: UL Burst: DL Burst:
Conform Action	Private IE to configure the conform action: Uplink Action: Uplink ToS: Downlink Action: Downlink ToS:
Exceed Action	Private IE to configure the exceed action: Uplink Action: Uplink ToS: Downlink Action: Downlink ToS:

Display the FAR, PDR, QER, and URR in 'show subscribers user-plane-only callid <> far|qer full all'.

Processing of QGR on UPlane

- On Receiving a IE 'Qos-Group-Of-Ruledef', search for the QGR in static configuration. For each ruledef/group-of-ruledef in QGR, look up for its corresponding PDR and update the FAR/QER list with the received QGR FAR/URR/QER IDs.
- For each ruledef/group-of-ruledef PDR on UPlane, associate high priority QGR's FAR-id, QER-id.

- Maintain QGR map at both Control and UPlane, it consists of QGR name, precedence, QER-ID, and FAR-ID. Use QGR map for recovery and lookup whenever required.

QGR Hit in Data Path

- For a packet matching rule PDR, search for the highest priority QGR FAR, and QER and enforce the parameters.
- Enforce flow-status and flow-rate as expected.
- QGR matching for Offloaded Flows are handled.
- QGR hit statistics are incremented.

Limitations

The QoS Group of Ruledefs support feature has the following limitations:

- URR creation and enforcement is not supported.
- Inclusion of dynamic-rules in static QGR definition is not supported.
- Flow-Status Redirect and Kill Flow are not supported.
- QoS Group Conform action as Drop and Exceed action as ALLOW or MARK_DSCP are not supported.
- CP can communicate maximum 20 QGRs received over PCRF to UP.

Monitoring and Troubleshooting

This section provides information about CLI commands available for monitoring and troubleshooting the feature.

Show Commands and Outputs

This section provides information about show commands and their outputs in support of this feature.

show subscribers user-plane-only full all

The output of this show command has been enhanced to include the following fields introduced in support of this feature.

- Total QoS-Group Active
- QoS-Group Statistics
 - QGR Name
 - Pkts-Down
 - Bytes-Down

- Pkts-Up
- Bytes-Up
- Hits
- Match-Bypassed
- FP-Down(Pkts/Bytes)
- FP-Up(Pkts/Bytes)

show user-plane-service qos-group-of-ruledefs all name

The output of this show command has been enhanced to include the following fields introduced in support of this feature.

QGR-INFO-LIST

- Value
- Number of QGRs
- QGR INFO
 - NAME
 - PRECEDENCE
 - OPERATION
 - FAR ID
 - QER ID
- QGR INFO
 - NAME
 - PRECEDENCE
 - OPERATION
 - FAR ID
 - QER ID

show subscribers user-plane-only callid 00004e21 qos-group all

The output of this show command has been enhanced to include the following fields introduced in support of this feature.

```

Callid: 00004e21
      Interface Type: Sxb
      QGR-Name:      Priority:      FAR-ID:      QER-ID:      URR-ID:
      -----      -
Total Number of QGRs found:

```

show subscribers user-plane-only callid 00004e21 far full all

The output of this show command has been enhanced to include the following fields introduced in support of this feature.

- Associated with QGR
 - Extended Apply Action

show subscribers user-plane-only callid 00004e21 qer full all

The output of this show command has been enhanced to include the following fields introduced in support of this feature.

- UL Burst
- UL Conform Action
 - UL DSCP Value
- UL Exceed Action
 - UL DSCP Value
- DL Burst
- DL Conform Action
 - DL DSCP Value
- DL Exceed Action
 - DL DSCP Value

show subscribers user-plane-only callid 00004e21 qos-group statistics all name

This show command and its output is introduced to support of this feature.

- Flow-Status Statistics
 - Total Uplink Packets
 - Total Uplink Bytes
 - Uplink Packets Redirected
 - Uplink Bytes Redirected
 - Uplink Packets Dropped
 - Uplink Bytes Dropped
 - Uplink Packets Term-Flow
 - Uplink Bytes Term-Flow
 - Total Downlink Packets

- Total Downlink Bytes
- Downlink Packets Redirected
- Downlink Bytes Redirected
- Downlink Packets Dropped
- Downlink Bytes Dropped
- Downlink Packets Term-Flow
- Downlink Bytes Term-Flow

- Bandwidth-Control Statistics
 - Total Uplink Packets
 - Total Uplink Bytes
 - Uplink Packets QoS-Exceed
 - Uplink Bytes QoS-Exceed
 - Uplink Packets QoS-Conform
 - Uplink Bytes QoS-Conform
 - Uplink Packets Dropped
 - Uplink Bytes Dropped
 - Uplink Packets Marked
 - Uplink Bytes Marked
 - Total Downlink Packets
 - Total Downlink Bytes
 - Downlink Packets QoS-Exceed
 - Downlink Bytes QoS-Exceed
 - Downlink Packets QoS-Conform
 - Downlink Bytes QoS-Conform
 - Downlink Packets Dropped
 - Downlink Bytes Dropped
 - Downlink Packets Marked
 - Downlink Bytes Marked

- Total qos-group-of-ruledefs matched
- Total subscribers matching specified criteria

show user-plane-service statistics qos-group sessmgr all

Sessmgr Instance

- Total Uplink Pkt
- Total Uplink Bytes
- Uplink FP Pkts
- Uplink FP Bytes
- Total Dnlink Pkts
- Total Dnlink Bytes
- Dnlink FP Pkts
- Dnlink FP Bytes
- Flow-Status Statistics
 - Total Uplink Packets
 - Total Uplink Bytes
 - Uplink Packets Redirected
 - Uplink Bytes Redirected
 - Uplink Packets Dropped
 - Uplink Bytes Dropped
 - Uplink Packets Term-Flow
 - Uplink Bytes Term-Flow
 - Total Downlink Packets
 - Total Downlink Bytes
 - Downlink Packets Redirected
 - Downlink Bytes Redirected
 - Downlink Packets Dropped
 - Downlink Bytes Dropped
 - Downlink Packets Term-Flow
 - Downlink Bytes Term-Flow
- Bandwidth-Control Statistics
 - Total Uplink Packets
 - Total Uplink Bytes
 - Uplink Packets QoS-Exceed
 - Uplink Bytes QoS-Exceed

- Uplink Packets QoS-Conform
- Uplink Bytes QoS-Conform
- Uplink Packets Dropped
- Uplink Bytes Dropped
- Uplink Packets Marked
- Uplink Bytes Marked
- Total Downlink Packets
- Total Downlink Bytes
- Downlink Packets QoS-Exceed
- Downlink Bytes QoS-Exceed
- Downlink Packets QoS-Conform
- Downlink Bytes QoS-Conform
- Downlink Packets Dropped
- Downlink Bytes Dropped
- Downlink Packets Marked
- Downlink Bytes Marked



CHAPTER 69

RADIUS in C-Plane

- [Revision History](#), on page 663
- [Feature Description](#), on page 663
- [How It Works](#), on page 663
- [Configuring RADIUS in C-Plane](#), on page 665
- [Monitoring and Troubleshooting](#), on page 666

Revision History



Note Revision history details are not provided for features introduced before release 21.24.

Revision Details	Release
First introduced	Pre 21.24

Feature Description

The C-Plane in CUPS uses the existing non-CUPS RADIUS framework without any impact on non-CUPS functionality. Mapping is done between existing non-CUPS data structures and CUPS-specific data structures like Packet Detection Rule (PDR), Usage Reporting Rule (URR), Forwarding Action Rule (FAR), and so on.

The P-GW supports accounting messages to report volume usage (bytes and packets) in each bearer to RADIUS. For RADIUS in CUPS C-Plane, it creates bearer level URR for calls enabled with RADIUS/Mediation accounting, and corresponding URR from U-Plane is communicated in AAA messages.

How It Works

The RADIUS in C-Plane works as explained in the following sections.

C-Plane Handling of RADIUS

URR Creation during Session Setup

The Sx Session establishment request framework is used to create a new RADIUS bearer level URR. This is tagged to rule base PDR that is created. As a result, any data matching static rules is accounted in this URR by U-Plane. The same URR is associated to every PDR created on this bearer for Dynamic/Pre-defined rules, installed on the bearer from Gx.

URR Processing in Detach Request

The URR information for RADIUS bearer is sent by P-GW U-Plane as part of Sx Session Delete Response. The P-GW CPlane does the mapping of these URRs to their corresponding non-CUPS RADIUS buckets in SessMgr, which is used by AAAMgr to encode and send RADIUS messages.

An API is created in SessMgr to be called by ACSMgr. The C-Plane, using this API, updates the non-CUPS buckets in SessMgr whenever U-Plane reports the URR.

URR Processing in Detach Request

The P-GW U-Plane sends the Usage report for triggers like Volume/Time-Threshold and the C-Plane does the mapping of URRs to their corresponding charging buckets. The C-Plane takes the value of Volume/Time-Threshold from AAA Server Group (radius accounting interim volume/interval) CLI commands associated with the call. When interim is not configured under AAA Server Group, the Time-threshold reporting trigger is used for RADIUS bearer URR with a value of 0x7FFFFFFF.

URR Handling for RADIUS

The RADIUS only has bearer level URR and whenever U-Plane reports the same, it updates the non-CUPS RADIUS buckets in SessMgr.

Currently, reporting of bytes from U-Plane is supported. Same framework is extended to support reporting of packets for RADIUS.

The C-Plane, when creating URR, requests to report packets usage to U-Plane and the information reported is used to populate non-CUPS buckets. New IE is created for this purpose, and encoding and decoding of these IEs over Sx interface is supported.

U-Plane Handling of RADIUS

URR Support in Session Establishment Request

U-Plane module supports the storage of a list of URRs received as part of Session Establishment Request. Each PDR can be associated with one or more URRs, and a particular URR can be linked to another URR.

Each URR contains the measurement method (time/volume), and reporting triggers that indicates the event on which the UPlane has to send usage report.

Separate support is added to store and report packets for RADIUS URR.

Session Report Request Message

On encountering a time or volume threshold limit, U-Plane generates an Sx Session Report Request message and sends the same to C-Plane. This message contains the Usage report which indicates the reason for generating

the message, specified by Usage Report Trigger. In addition to this, the Usage report contains the time/volume/packets measurement.

If any other URRs are linked to the URR for which the session report request is being generated, then a session report request is generated for those linked URRs as well.

Session Delete Response

This message, sent from the U-Plane, is in response to a Session Deletion Request from C-Plane. This results in termination of the Sx Session at U-Plane. Usage Report is included as part of Sx Delete Session Response.

Session Report Response message

This message from the C-Plane indicates a successful delivery of the Session Report Request message with a cause code. Currently, no specific failure handling is done on receiving a failure cause.

Information Elements for Packet Reporting

The following new IEs are supported to request packet usage information for U-Plane, and to report packet information from U-Plane:

- Extended Measurement Method - Indicates the method for measuring the usage of network resources.
- Figure Extended Measurement Method - This is not a mandatory IE for any Message. This IE can be present in following Messages between C-Plane and U-Plane: Sx Session Establishment over Sxa, Sxb, Sxc, Sxab. Similarly, Usage Report from U-Plane is enhanced to support packet information.
- Packet Measurement - The Packet Measurement IE contains the measured traffic volume in packets. This is not a mandatory IE for any Message. This IE can be present in following Messages between C-Plane and U-Plane:
 - Sx Session Modification over Sxa, Sxb, Sxc, Sxab
 - Sx Usage Report Session Deletion Response over Sxa, Sxb, Sxc, Sxab
 - Sx Usage Report Session Report Request over Sxa, Sxb, Sxc, Sxab

Limitation and Restriction

Following is the known limitation and restriction of this feature:

- The **radius interim accounting now** CLI is not supported in CUPS architecture.
- Event based Usage reporting for RAT change is not supported.

Configuring RADIUS in C-Plane



Note The CLI commands available for non-CUPS RADIUS is applicable in CUPS environment and they can be used to configure RADIUS in C-Plane.

Monitoring and Troubleshooting



Note The CLI commands available for non-CUPS RADIUS is applicable in CUPS environment and they can be used to monitor and troubleshoot the RADIUS in C-Plane.



CHAPTER 70

Radius Packet Disconnect

- [Revision History, on page 667](#)
- [Feature Description, on page 667](#)
- [High Level Requirements, on page 667](#)
- [Change-of-Authorization Messages, on page 668](#)
- [Message Exchange, on page 668](#)
- [RADIUS-Initiated Disconnect Messages, on page 668](#)
- [Message Exchange, on page 669](#)
- [Configuring Radius Change Authorization NAS-IP-Address Functionality, on page 669](#)

Revision History

Revision Details	Release
First introduced	21.26

Feature Description

The RADIUS change of authorization provides a mechanism to change authorization dynamically after the device is authenticated. Once there is a policy change, you can send RADIUS CoA packets from the authorization server to reinitiate authentication and apply the new policy. The RADIUS CoA process allows you to change the user access immediately when needed, without the need to wait for the wired switch or access point to initiate a re-authentication process, or for the device to disconnect and re-connect again.

It is now possible to define more than one radius Change of Authorization (CoA) NAS IP address per context in a context with multiple APNs using different RADIUS servers and different NAS IP addresses.

High Level Requirements

The following table provides the high level requirements for the existing architecture:

Module	Requirements
CLI	You must be able to configure multiple Radius COA NAS-IP-Address in a single context.
SCTRL	You must be able to configure multiple Radius CoA NAS-IP-Address in a single context. These multiple Radius CoA NAS-IP-Address must be broadcasted by SCTRL to all the AAAMGR instances.
AAAMGR	Change the AAAMGR configuration to allow the opening of multiple NAS-IP-Address sockets inside a context. AAAMGR must be able to receive CoA or DM messages on different NAS-IP-Address inside the same context.

Change-of-Authorization Messages

The RADIUS dynamic-request server receives and processes the unsolicited Change-of-Authorization (CoA) messages from RADIUS servers. The RADIUS-initiated CoA feature uses the following codes in its RADIUS request and response messages:

- CoA-Request (43)
- CoA-ACK (44)
- CoA-NAK (45)

Message Exchange

The RADIUS server and the router's RADIUS dynamic-request server exchange messages using UDP. The COA-Request message sent by the RADIUS server has the same format as the Disconnect-Request packet that is sent for a disconnect operation.

The response is either a COA-ACK or a COA-NAK message:

- If AAA successfully changes the authorization, the response is a RADIUS-formatted packet with a COA-ACK message, and the data filter is applied to the session.
- If AAA is unsuccessful, the request is malformed, or attributes are missing, the response is a RADIUS-formatted packet with a COA-NAK message.

RADIUS-Initiated Disconnect Messages

This section describes the RADIUS dynamic-request server's RADIUS-initiated disconnect feature.

To centrally control the disconnection of remote access users, the RADIUS dynamic-request server on the router must receive and process unsolicited messages from RADIUS servers.

The RADIUS-initiated disconnect feature uses the existing format of RADIUS disconnect request and response messages. The RADIUS-initiated disconnect feature uses the following codes in its RADIUS request and response messages:

- Disconnect-Request (40)
- Disconnect-ACK (41)
- Disconnect-NAK (42)

Message Exchange

The RADIUS server and the router's RADIUS dynamic-request server exchange messages using User Datagram Protocol (UDP). The Disconnect-Request message sent by the RADIUS server has the same format as the COA-Request packet that is sent for a change of authorization operation.

The disconnect response is either a Disconnect-ACK or a Disconnect-NAK message:

- If AAA successfully disconnects the user, the response is a RADIUS-formatted packet with a Disconnect-ACK message.
- If AAA cannot disconnect the user, the request is malformed, or attributes are missing from the request, the response is a RADIUS-formatted packet with a Disconnect-NAK message.

Configuring Radius Change Authorization NAS-IP-Address Functionality

The following CLI configures the CP to receive CoA messages from the Radius server and returns an acknowledgment to the server.

```
configure
  context context_name
    radius change-authorize-nas-ip ip_address
      [ encrypted ] key secret
      { port port }
      { no-reverse-path-forward-check }
      { timestamp-window <0-4294967295>}
    exit
  exit
```

Allow multiple rows of the **radius change-authorize-nas-ip** CLI command within certain context. You can configure a maximum of 32 such rows within certain context.

Show Commands and Outputs

This section provides information about the show CLI commands available in support of the feature. Run the show command within certain context.

- **show radius counters**
- **show radius info instance**
- **show session subsystem facility aaamgr instance**



CHAPTER 71

RADIUS Server State

- [Revision History](#), on page 671
- [Feature Description](#), on page 671
- [How it Works](#), on page 671
- [Configuring AAA RADIUS Servers](#), on page 672
- [Monitoring and Troubleshooting](#), on page 672

Revision History



Note Revision history details are not provided for features introduced before release 21.24.

Revision Details	Release
The feature is available in 21.25 and later releases.	21.25
First introduced.	Pre 21.24

Feature Description

This feature enables the RADIUS server to indicate the appropriate state regardless of the timing of keep-alive transmissions.

How it Works

When the AAA RADIUS servers are configured, the Authentication server state is set to "INIT". In "INIT" state, the server is initialized with the context-specific configuration and prepared to send the Access request. Once the Access request is sent, the server state is moved to "Active Pending". After receiving positive response on the SRP Active chassis, the server state is moved to "ACTIVE". Meanwhile, after configuring the Accounting server, the state is set as "Active" on both chassis.

To implement this feature, the server states are updated at the time of initial configuration and during Interchassis Session Recovery (ICSR) switchover on SRP Standby Chassis. Initially on standby chassis,

servers are kept in “Active Pending” state, as the RADIUS servers are being initialized with the context-specific configuration. After the configuration completion, Access-request is sent for the Authentication server, and accounting request is sent for the accounting server as a significance of keep-alive messages. But, no response is received for these keep-alive messages because of the standby chassis. So, after the keep-alive timeout, the server state is automatically changed to “Down”.

In ICSR switchover scenario, when SRP messages are received on the Active chassis, which is going to be a new Standby chassis, the state of the servers are changed to “Active Pending”. As per the state flow, keep-alive messages are sent towards the RADIUS servers, and like the previous scenario, no response is received from the RADIUS servers. So, after the keep-alive timeouts, the server state is automatically changed to “Down”.

Configuring AAA RADIUS Servers

There is no specific configuration required for this feature. When you configure any RADIUS accounting server, it displays the appropriate state according to the chassis state.

The following is a sample configuration for configuring the AAA RADIUS servers:

```

config
 context ISP1
  apn intershat
  mediation-device context-name ISP1
  exit
exit
config
 context ISP1
  aaa group default
  radius attribute nas-ip-address address 209.165.200.225
  radius accounting interim interval 60
  radius mediation-device accounting server 209.165.200.226 key secret port 1813
  radius keepalive timeout 4
  radius keepalive retries 3
  radius keepalive interval 30
  radius accounting algorithm round-robin
  radius accounting detect-dead-server keepalive
  radius accounting keepalive timeout 4
  radius accounting keepalive username 001001110990001@pgw.keepalive
  radius accounting keepalive calling-station-id 999255255255005
  radius accounting keepalive framed-ip-address 255.255.255.224
  radius max-retries 0
  radius accounting max-retries 0
  radius max-transmissions 2
  radius accounting max-transmissions 2
  radius timeout 1
  radius accounting timeout 15
  no radius accounting archive
  exit
exit
exit
exit

```

Monitoring and Troubleshooting

This section describes the CLI commands available to monitor and/or troubleshoot the feature.

Show Commands and Outputs

show radius accounting servers detail

Use this CLI command to display the RADIUS Accounting server details configured in a particular context.

show radius authentication servers detail

Use this CLI command to display the RADIUS Authentication server details configured in a particular context.



CHAPTER 72

Rate Limiting Function (RLF)

This chapter contains the following topics:

- [Revision History](#), on page 675
- [Feature Description](#), on page 675

Revision History



Note Revision history details are not provided for features introduced before release 21.24.

Revision Details	Release
First introduced	Pre 21.24

Feature Description

The RLF feature implements a generic framework that can be used by multiple interfaces and products for rate-limiting/throttling outgoing messages like Diameter messages on Gx, Gy interface towards PCRF.



Important The working of RLF feature, including the CLI commands, in the CUPS architecture is similar to how it works in the non-CUPS environment.

When applications send messages to peers at a high rate (for example, when a large number of sessions goes down at the same time), accounting stop messages for all the sessions are generated at the same time) the peer may not be able to handle the messages at such high rates. To overcome this situation, the Rate Limiting Function (RLF) framework is developed so that the application sends messages at an optimal rate such that peer is capable of receiving all the messages and does not enter an overload condition.

This feature can be enabled using the **rlf-template** CLI command in the Global Configuration mode. The users can define the rate limiting configurations within this template. For more information on the command, see the *Command Line Interface Reference*.



Important RLF template cannot be deleted if it is bound to any application (peers/endpoints).

When RLF feature is enabled, all the messages from the application are pushed to the RLF module for throttling and rate control, and depending on the message-rate configured the RLF module sends the messages to the peer. Once the rate or a threshold value is reached, the RLF module notifies the application to slow down or stop sending messages. RLF module also notifies the application when it is capable of accepting more messages to be sent to the peer. RLF module typically uses a Token Bucket Algorithm to achieve rate limiting.

Currently in the deployment of the Diameter applications (Gx, Gy, and so on), many operators make use of **max-outstanding number** CLI command as a means of achieving some rate-limiting on the outgoing control traffic. With RLF in place, this is no longer required since RLF takes care of rate-limiting in all cases. If both RLF and **max-outstanding** is used, there might be undesirable results.



Important If RLF is being used with a **diameter endpoint**, then set the **max-outstanding** value of the peer to be 255.

To use the template, Diameter or any other applications must be associated with the template. The RLF provides only the framework to perform the rate limiting at the configured Transactions Per Second (TPS). The applications (like Diameter) should perform the configuration specific to each application.



CHAPTER 73

S2a Interface Support

- [Revision History, on page 677](#)
- [Feature Description, on page 677](#)

Revision History



Note Revision history details are not provided for features introduced before release 21.24.

Revision Details	Release
First introduced	Pre 21.24

Feature Description

This reference point supports the bearer interface by providing signaling and mobility support between a trusted non-3GPP access point (Trusted WiFi Gateway (TWAN)/Converged Access Gateway (CGW)) and PDN Gateway (P-GW). It is a GTP based interface support that allows the connectivity to the trusted non-3GPP IP access points. The S2a interface uses IPv4 and IPv6 for both control and data.

Supported Protocols

The S2a interface supports the following protocols:

- Transport Layer: UDP, TCP
- Tunneling: GTP IPv6
- Network Layer: IPv4, IPv6
- Data Link Layer: ARP
- Physical Layer: Ethernet

Figure 44: Protocols Supported on the S2a Interface

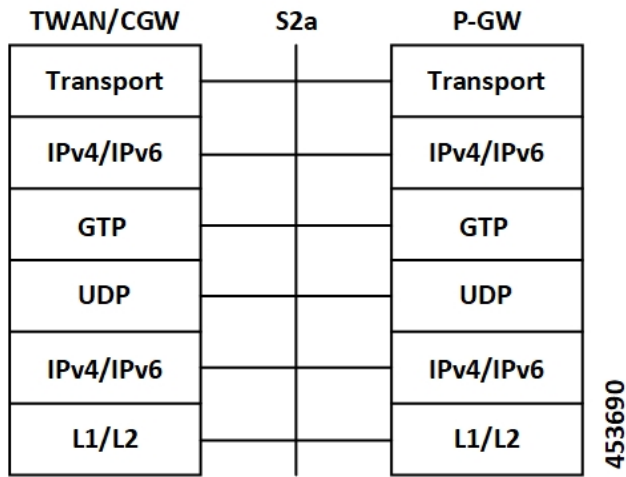



CHAPTER 74

S2b Interface Support

- [Feature Description, on page 679](#)

Feature Description

In CUPS architecture, support is added for S2b interface where untrusted Wi-Fi calls from ePDG connects to SAEGW (Pure-P).

Currently, support for following procedures are available:

- Support procedures for session establishment:
 - GTP based S2b for roaming, non-roaming and LBO (3GPP TS 23.402 [4] clause 7.2.4).
 - Emergency services over GTP based S2b (3GPP TS 23.402 [4] clause 7.2.5).
 - UE-initiated connectivity to additional PDN from Un-trusted Non-3GPP IP Access with GTP (3GPP TS 23.402 [4] clause 7.6.3).
- Support procedures for session release:
 - UE/ePDG-initiated detach procedure with GTP on S2b (TS 23.402 [4] clause 7.4.3.1).
 - HSS/AAA-initiated detach procedure with GTP on S2b (TS 23.402 [4] clause 7.4.4.1).
- Support procedure for bearer deactivation:
 - P-GW Initiated Bearer Deactivation with GTP on S2b (TS 23.402 [4] clause 7.9.2).



CHAPTER 75

S6b Support

- [Revision History](#), on page 681
- [S6b Support](#), on page 681

Revision History



Note Revision history details are not provided for features introduced before release 21.24.

Revision Details	Release
First introduced	Pre 21.24

S6b Support

The S6b interface reference point, between a P-GW and a 3GPP AAA server/proxy, is used for mobility-related authentication. It is also used to retrieve and request parameters related to mobility and to retrieve static QoS profiles for UEs (for non-3GPP access) in the event that dynamic PCC is not supported.



Important The working of S6b interface, including the CLI commands, in the CUPS architecture is similar to how it works in the non-CUPS environment. For additional information on S6b interface support, refer the *P-GW Administration Guide*.



CHAPTER 76

S-GW CDR in CUPS

- [Revision History](#), on page 683
- [Feature Description](#), on page 683

Revision History



Note Revision history details are not provided for features introduced before release 21.24.

Revision Details	Release
First introduced	Pre 21.24

Feature Description

CDR generation is supported for S-GW in the Cisco UPC CUPS architecture.

CDRs in CUPS is generated to collect charging information for UE bearers in S-GW. On receiving a charging trigger, the Control Plane node of CUPS pulls the information from the corresponding user plane nodes and the collected volume counts are added to the S-GW CDR.

S-GW CDR is supported for both default and dedicated bearer.



Note Currently, S-GW CDR is supported in custom24 dictionary.

Charging data is collected based on the following triggers:

- Access-side triggers:
 - ULI Change
 - RAT Change
 - Management intervention (Interim CDRs are not supported)

- Normal/Abnormal call release
- Network-side triggers:
 - QCI Change
 - APN AMBR Change



CHAPTER 77

S-GW New Call Rejection

- [Feature Description, on page 685](#)
- [How It Works, on page 685](#)
- [Configuring S-GW New Call Rejection, on page 686](#)
- [Monitoring and Troubleshooting, on page 687](#)

Feature Description

This CLI-controlled feature allows to reject Pure-S calls based on subscriber type (Roamer, Homer, Visitor), and/or APN.



Note This feature is applicable only when CUPS is enabled.

How It Works

When a new call arrives at S-GW, and if the feature CLI is enabled with which the APN of the call matches to the one configured through the CLI, the call is rejected. This feature works by identification of the type of subscribers—homer, visitor, or roamer. This identification is done in the following way:

- If the PLMN ID of S-GW is same as that of PGW and International Mobile Subscriber Identity (IMSI), the subscriber is identified as homer.
- If the PLMN ID of S-GW differs from PLMN ID of PGW irrespective of IMSI, the subscriber is identified as roamer. For example, if MS-1 is subscribed to PLMN1 and is connected to an SGW in PLMN2, then from PLMN2, MS-1 initiates a session with the PGW in PLMN1. In this scenario, MS-1 is roamer.
- Subscribers whose IMSI contains a foreign PLMN ID are identified as visitors.

The S-GW rejects all sessions of APNs that are configured for home, visitor, or roamer subscriber. Initial attach CS Request and UE requested additional PDN connection CS requests for Pure-S calls are also considered for rejection. The CS request is rejected with GTPV2 cause *No Resource Available*. The expected behaviour is that the MME reattempts attach based on this cause code, and blacklist this S-GW based on its blacklist algorithm implementation.

A configuration for list of APNs (maximum 10), which needs to be rejected by S-GW for homer and roamer subscribers, is required.

In case of SAEGW deployment, only Pure-S calls are rejected. If SAEGW receives CS request for collapsed call, then this call is not rejected even if corresponding APN is configured in the reject list.

Emergency or eMPS calls are not rejected, despite IMS APN being configured for new call reject, when:

- The S-GW receives CS request with IMS APN and unauthenticated imsi flag set.
- The S-GW receives CS request with IMS APN and eARP value is configured as eMPS eARP in S-GW service.



Note In the CS Request, eARP is received by S-GW, which is not configured as eMPS eARP. While in CS Response, the S-GW can receive new authorized eARP which can mark sessions as eMPS session. However, if the feature is enabled in case of CS Response, sessions are rejected while handling CS Request only.

Limitations

When Pure S call is rejected through new call reject policy, the rejection statistics is collected under *New Call Policy Rejection Stats* section of the **show saegw-service statistics all function sgw** CLI command. Other SGW-related statistics for the rejected call are not collected.

Configuring S-GW New Call Rejection

This section provides information on configuration commands to enable and disable support for S-GW to reject new calls.

Enabling New Call Rejection

Use the following configuration commands to reject calls at S-GW for roamer, home, visitor subscribers, and APN subscribers.

```
configure
  context context_name
    sgw-service sgw-service_name
      [ default | no ] newcall reject { roamer | home [ apn apn_name ]
    | visitor [ apn apn_name ]
      end
```

NOTES:

- **default**: Resets the command to its default setting - Disabled.
- **no**: Disables the rejection of all calls for the specified subscriber.
- **newcall**: Configures a new call for the configured S-GW service.
- **reject**: Configures newcall reject-policy for the configured S-GW service home, visitor, or roamer subscriber.

- **roamer**: Configures newcall reject-policy for the configured S-GW service for roamer subscriber.
- **home**: Configure newcall reject-policy for the configured S-GW service for home subscriber.
- **visitor**: Configures newcall reject-policy for the configured S-GW service for visitor subscriber.
- **apn-name** *apn_name*: Configures the APN name (for maximum of 10 APN profiles) to reject call for the configured S-GW service for home or visitor subscriber.

Monitoring and Troubleshooting

This section provides information regarding commands available to monitor and troubleshoot the new call and APN session rejection at S-GW.

Show Command(s) and/or Outputs

This section provides information about show commands and the fields that are introduced in support of new call and APN session rejection at S-GW.

show saegw-service statistics all function sgw

The output of this show command has been modified to display apn-profiles that are configured in sgw-service for new call rejection. Following fields are introduced:

- New Call Policy Rejection Stats
- New Calls
 - Visiting Subscriber
 - Home Subscriber
 - Roaming Subscriber

show sgw-service name

The output of this show command has been modified to display apn-profiles that are configured in sgw-service for new call rejection. Following fields have been introduced:

- SGW Reject Calls Visitor Subs
- SGW Reject Calls Roamer Subs
- SGW Reject Calls Home Subs

show sgw-service name



CHAPTER 78

SAEGW Idle Buffering with DDN Delay and DDN Throttling

- [Revision History, on page 689](#)
- [Feature Description, on page 689](#)
- [How It Works, on page 690](#)
- [SAEGW Idle Buffering with DDN Delay and DDN Throttling Support Configuration, on page 699](#)

Revision History



Note Revision history details are not provided for features introduced before release 21.24.

Revision Details	Release
The number of packets to be buffered per FAR on UP is configurable in this release. Use the buffering-limit far-max-packets <i>far_max_packets</i> CLI command in the ACS Configuration mode to configure buffered packets per FAR. You can configure more number of FAR buffered packets to achieve QoS with fewer packet drops.	21.28.m23
First introduced.	Pre 21.24

Feature Description

The Downlink Data Notification (DDN) messages with support for DDN Delay and DDN Throttling, and buffering in SAEGW, when UE is in Idle State, is supported in CUPS architecture.

How It Works

This section provides an overview of how this feature works.

- Buffering is supported at SAEGW-U.
- Support of buffering starts when UE moves to IDLE state due to Release Access Bearer.
- ACTIVE to IDLE transition:
 - When the UE moves to ECM-IDLE state, since the SAEGW supports buffering capability and decides to activate buffering in SAEGW-U for the session, the SAEGW-C informs the SAEGW-U through an Sx session modification.
 - After the buffering starts, when the first downlink packet arrives on any bearer, the SAEGW-U informs the SAEGW-C. The SAEGW-U sends an Sx reporting message to the SAEGW-C, unless specified otherwise, and identifies the S5/S8 bearer on which the downlink packet is received.
 - On receiving the reporting message, the SAEGW-C decides whether to send a DDN message to the MME, as defined in 3GPP TS 23.401 [2]. The DDN notification is sent with the Sx-Usage-Report.
- IDLE to ACTIVE transition:
 - At the UE transition to ECM-CONNECTED state, the SAEGW-C updates the SAEGW-U through Sxa interface with the F-TEIDu of the eNodeB/RNC/SGSN. The buffered data packets, if any, are then forwarded to the eNodeB/RNC/SGSN by the SAEGW-U.
- If the Apply Action is BUFFER, and SGW-U recovers, the SGW-U initiates Sx Report (with DLDR Report Type) on arrival of the downlink data packet.
- In SGW-U, a timer is implemented that starts after each Sx Report (with DLDR report Type) is sent. If the Apply Action is not changed then on timer expiry, Sx Report (with DLDR Report Type) gets initiated again.
- ARP of the bearer is included in the DDN message.
- In a multi-PDN session, if the DDN is initiated for one PDN and then data is received on another PDN, wherein the bearer has higher priority, then the DDN is initiated again with the higher priority ARP value.

Downlink Data Notification – Delay (DDN-D) Support

Under certain conditions, when UE triggers a service request, uplink and downlink data is triggered and is received at the SGW-C even before the Modify Bearer Request (MBR) is received causing unnecessary Downlink Packet Notification messages sent that increases the load in MME.

In such cases, the MME monitors the rate at which these events occur. If the rate becomes significant (as configured by the operator) and the MME's load exceeds an operator configured value, the MME indicates "Delay Downlink Packet Notification Request" with parameter D to the Serving Gateway, where D is the requested delay given as an integer with multiples of 50 milliseconds, or zero. The S-GW then uses this delay in between receiving downlink data and sending the Downlink Data Notification message.

The Downlink Data Notifications are supported for both Collapsed and Pure-S calls.

Due to the distributed nature of the system, sessions from a particular MME are offloaded on different session managers. Therefore, all session managers are notified when a session is offloaded. Also, the functionality is designed to not allow all session managers to message the DEMUX manager.

- In DDN Delay feature, DDN delay timer support is at Control Plane.
- When first data packet arrives, Sx Report message is initiated but DDN message is initiated from Control Plane after the expiry of Delay timer.
- DDN Delay feature is a peer level feature and so, it is applied for all the session on that peer from where the DDN Delay value is received.
- In case a previous delay value was received from a peer and it is absent in the current message, the delay value will be considered as 0.

Session Recovery and ICSR is supported for DDNs.

DDN Throttling Support

Too many DDN requests towards MME from SGW-C could lead to processing overload at MME. To reduce this load, MME dynamically requests SGW-C to reduce a certain percentage of DDN messages sent towards it for a given period time.

For DDN throttling, S-GW is required to drop a given percentage of DDNs over a given period of time. S-GW implements this functionality using a probabilistic algorithm at each session manager.

Whereas, the conventional implementation of DDN throttling requires each session manager to share its list of pending DDNs for low priority bearers with a central entity that would then calculate the net load of pending DDNs and then decide how many DDNs each session manager would have to drop. This implementation would require buffering of DDN messages at session manager. Also, due to distributed processing nature of software subsystem in chassis, it would require considerable amount of messaging between the session managers and the central entity (demuxmgr in case of Boxer) at regular intervals.

Implementing a probabilistic algorithm removes the need for buffering at session manager and also messaging with demuxmgr. Accuracy of probabilistic algorithm increase with increasing low ARP priority paging load at session manager. Even with lower paging load, accuracy would be fairly close to the throttling factor provided.

For non-release 10 compliant MME, SGW_C provides option to enable throttling through the CLI.

Threshold ARP values for low priority bearer must be configured through S-GW Service Configuration. For example, if configured ARP value is 9, any bearer with ARP > 9 is considered low priority bearer. DDN throttling is enabled through this configuration. If DDN throttling is enabled through SGW service configuration, each DDN message towards MME would contain the ARP IE.

No User Connect Timer Support

- Timer is introduced when a Modify Bearer Request is not received after positive Downlink Data Notification acknowledgment.
- It is initiated at SGW-C when DDN acknowledgment is received.
- On arrival of Modify Bearer Request, SGW-C stops this timer.
- On timer expiry SGW-C informs SGW-U to drop buffered packets.

DDN Call Flows

DDN Success Scenario

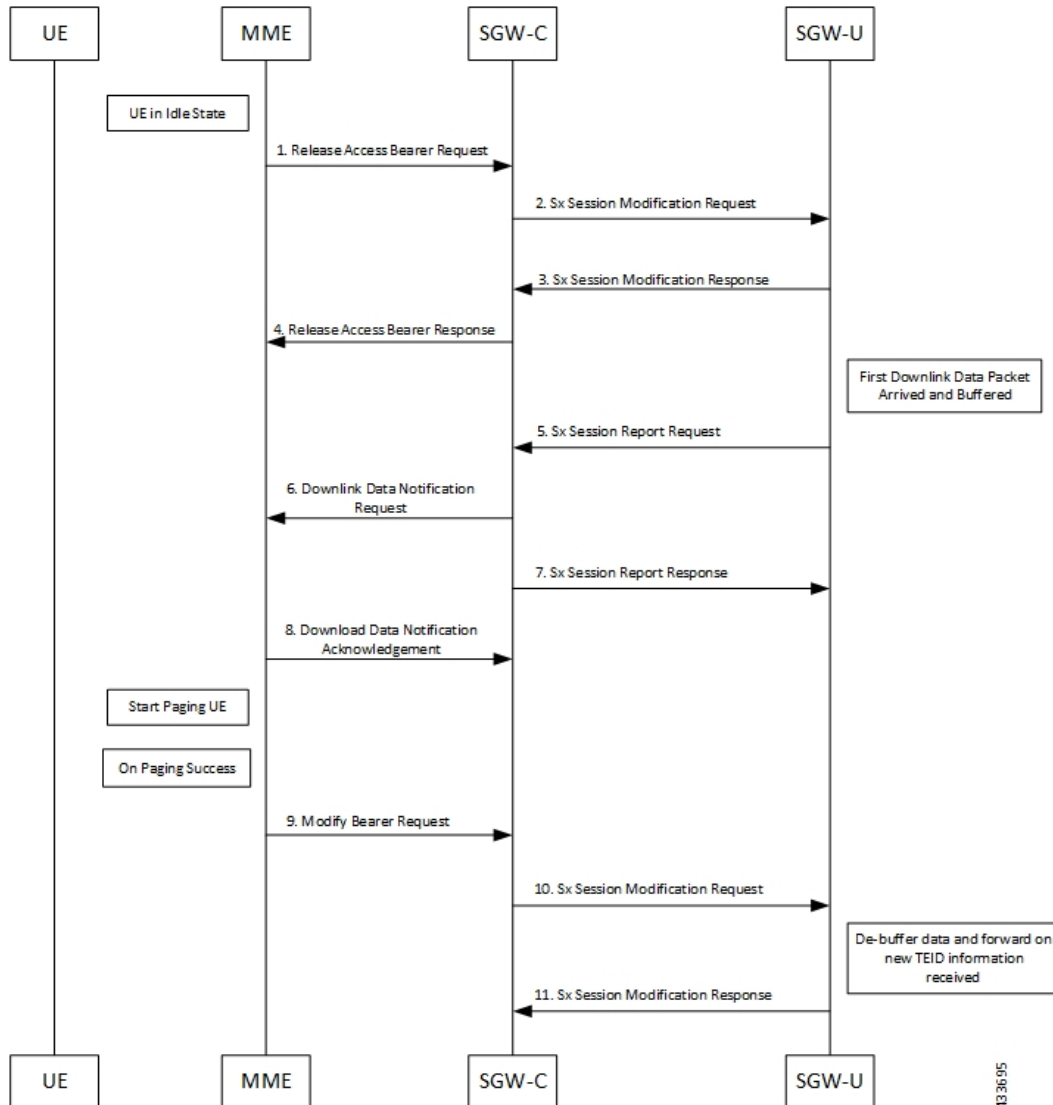

1. MME sends Release Access Bearer request to SGW-C to release downlink remote TEIDs of all the bearers for that UE.
2. On arrival of Release Access Bearer request, SGW-C informs the same to SGW-U by updating FAR with Apply Action as BUFFER in Sx Modification Request for all the PDNs.
3. SGW-U send Sx Modification response after applying Buffering in SGW-U for corresponding PDN.
4. SGW-C sends Release Access Bearer response to MME.
5. First Downlink data arriving in SGW-U triggers Sx Report Request (with Report Type as Downlink Data Report) towards SGW-C.

6. On arrival of Sx Report Request message, the SGW-C initiates Downlink Data Notification request message towards MME.
7. SGW-C sends Sx Report Response message towards SGW-U.
8. If MME is able to send a paging request towards UE, it sets the cause as “Request Accepted” in Downlink Data Notification Acknowledgment Message and sends it to SGW-C.
9. On successful paging, MME sends a Modify Bearer request to the S-GW with eNodeB TEIDs that sets up the S1-U connection at the SGW.
10. SGW-C sends Sx Modification request with updated FAR for new TEID information to SGW-U. SGW-U can now forward all the buffered data to UE through eNodeB.
11. SGW-U sends Sx Modification response to SGW-C.

DDN Failure Scenario

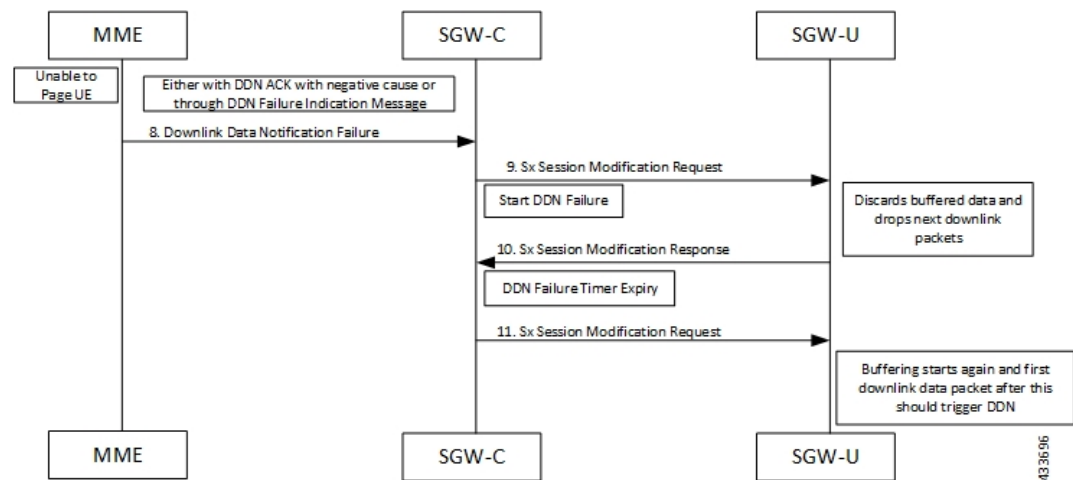

1. MME sends Release Access Bearer request to SGW-C to release downlink remote TEIDs of all the bearers for that UE.
 2. On arrival of Release Access Bearer request, SGW-C informs the same to SGW-U by updating FAR with Apply Action as BUFFER in Sx Modification Request for all the PDNs.
 3. SGW-U send Sx Modification response after applying Buffering in SGW-U for corresponding PDN.
 4. SGW-C sends Release Access Bearer response to MME.
 5. First Downlink data arriving in SGW-U triggers Sx Report Request (with Report Type as Downlink Data Report) towards SGW-C.
 6. On arrival of Sx Report Request message, the SGW-C initiates Downlink Data Notification request message towards MME.
 7. SGW-C sends Sx Report Response message towards SGW-U.
 8. If MME is not able to page UE then it can reject Downlink Data Notification Request with relevant cause.
- OR

No User Connect Timer Support

If MME accepts Downlink Data Notification Request. But later sends Downlink Data Notification Failure indication in order to indicate SGW-C that the UE did not respond to paging.

9. SGW-C received DDN failure and hence to stop sending next DDN immediately, SGW-C starts DDN Failure Timer. SGW-C sends Sx Modification Request with DROBU flag to discard buffered packets and Apply Action as DROP to drop subsequent packets.
10. SGW-U sends Sx Modification Response to SGW-C.
11. On DDN Failure Timer Expiry SGW-C initiates Sx Modification with Apply Action as BUFFER in order to start buffering again.

Further steps are continued from Step 3 in the [DDN Success Scenario, on page 692](#) call flow.

No User Connect Timer Support

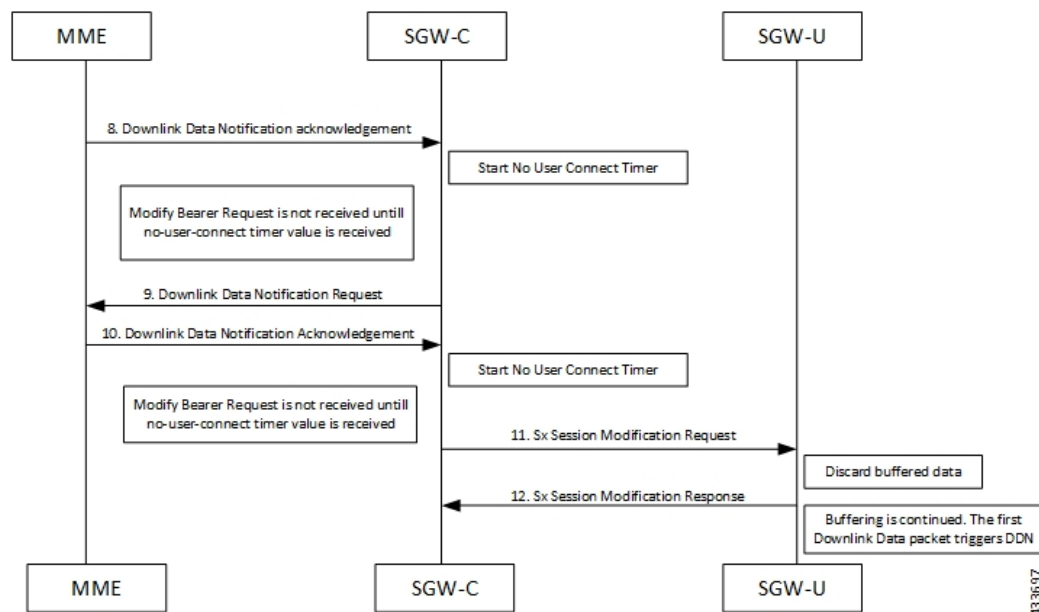

1. MME sends Release Access Bearer request to SGW-C to release downlink remote TEIDs of all the bearers for that UE.
2. On arrival of Release Access Bearer request, SGW-C informs the same to SGW-U by updating FAR with Apply Action as BUFFER in Sx Modification Request for all the PDNs.
3. SGW-U send Sx Modification response after applying Buffering in SGW-U for corresponding PDN.
4. SGW-C sends Release Access Bearer response to MME.
5. First Downlink data arriving in SGW-U triggers Sx Report Request (with Report Type as Downlink Data Report) towards SGW-C.
6. On arrival of Sx Report Request message, the SGW-C initiates Downlink Data Notification request message towards MME.
7. SGW-C sends Sx Report Response message towards SGW-U.

8. Downlink Data Notification Acknowledgment is received from MME. SGW-C starts no-user-connect timer.
9. If the Modify Bearer request with eNodeB TEID information is not received and no-user-connect timer expires, SGW-C sends Downlink Data Notification again.
10. Downlink Data Notification Acknowledgment is received from MME. SGW-C initiates the no-user-connect timer again.
11. SGW-C initiates Sx Session Modification request towards SGW-U with DROBU flag set in the message. On receiving this flag SGW-U drops the buffered data. New data will be buffered, and the subsequent first packet initiates a Sx Report message for initiating Downlink Data Notification message.
12. SGW-U sends Sx Modification Response.

DDN Delay Timer

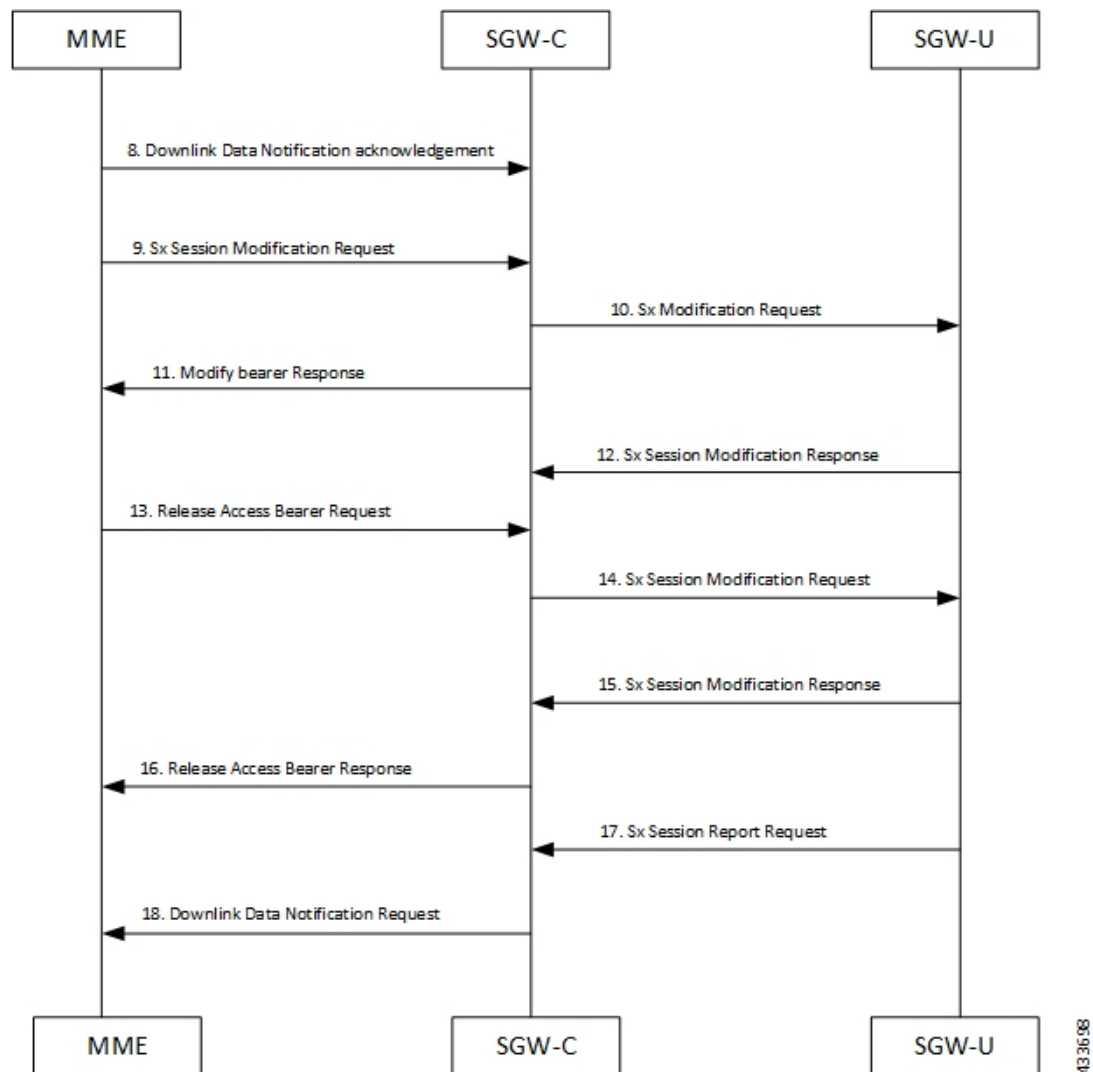

1. MME sends Release Access Bearer request to SGW-C to release downlink remote TEIDs of all the bearers for that UE.
2. On arrival of Release Access Bearer request, SGW-C informs the same to SGW-U by updating FAR with Apply Action as BUFFER in Sx Modification Request for all the PDNs.
3. SGW-U send Sx Modification response after applying Buffering in SGW-U for corresponding PDN.
4. SGW-C sends Release Access Bearer response to MME.
5. First Downlink data arriving in SGW-U triggers Sx Report Request (with Report Type as Downlink Data Report) towards SGW-C.
6. On arrival of Sx Report Request message, the SGW-C initiates Downlink Data Notification request message towards MME.
7. SGW-C sends Sx Report Response message towards SGW-U.
8. Downlink Data Notification Acknowledgment is received from MME with DDN Delay Timer value. This timer value will be saved for this peer , and now onwards every Downlink Data notification that we initiate should be after this delay for that peer.
9. On success paging, MME sends a Modify bearer request to the SGW with eNodeB TEIDs that sets up the S1-U connection at the SGW.
10. SGW-C sends Sx Modification Request with updated FAR for new TEID information to SGW-U. SGW-U can now forward all the buffered data to UE via eNodeB.
11. SGW-C sends Modify Bearer Response to MME.
12. SGW-U sends Sx Modification Response to SGW-C.
13. MME sends Release Access Bearer Request to SGW-C to release downlink remote TEIDs of all the bearers for that UE.
14. On arrival of Release Access Bearer Request, SGW-C inform the same to SGW-U via updating FAR with Apply Action as BUFFER in Sx Modification Request for all the PDNs.
15. SGW-U send Sx Modification Response after applying Buffering in SGW-U for corresponding PDN.
16. SGW-C sends Release Access Bearer Response to MME.
17. First Downlink data arriving in SGW-U triggers Sx Report Request (with Report Type as Downlink Data Report) towards SGW-C.
18. On arrival of Sx Report Request message, SGW-C starts DDN Delay Timer. On DDN Delay timer expiry SGW-C Initiates Downlink Data Notification message towards MME.

Sx Interface

Sx Session Level Reporting Procedure

Detection of first Downlink Data for Idle-Mode UE (by SAEGW-U):

When SAEGW-U receives the downlink packet but no S1-bearer for transmission and the buffering is performed by SAEGW-U, it reports the detection of first downlink data to SAEGW-C, for the purpose of paging the UE.

PCFP Session Report Request

The PCFP Session Report Request is sent over the Sxab interface by the User Plane function to report information related to a PCFP session to the Control Plane function.

Information elements	P	Condition / Comment	Appl.				IE Type
			Sxa	Sxb	Sxc	N4	
Report Type	M	This IE shall indicate the type of the report.	X	X	X	X	Report Type
Downlink Data Report	C	This IE shall be present if the Report Type indicates a Downlink Data Report.	X	-	-	X	Downlink Data Report

Downlink Data Report IE within PCFP Session Report Request

The Downlink Data Report grouped IE is encoded as shown in the following table.

Octet 1 and 2		Downlink Data Report IE Type = 83 (decimal)					
Octets 3 and 4		Length = n					
Information elements	P	Condition / Comment	Appl.				IE Type
			Sxa	Sxb	Sxc	N4	

PDR ID	M	This IE shall identify the PDR for which downlink data packets have been received at the UP function. More than one IE with this type may be included to represent multiple PDRs having received downlink data packets.	X	-	-	X	PDR ID
--------	---	--	---	---	---	---	--------

Notification to User Plane Function for DDN Failure

The Control Plane function notifies User Plane function for any failure so that buffered packets can be dropped and DDN related flags can be reset through DROBU flag in PFCP Sx Modification message.

PFCPSMReq-Flags	C	DROBU (Drop Buffered Packets): The CP function shall set this flag if the UP function is requested to drop the packets currently buffered for this PFCP session (see NOTE 1).
-----------------	---	---

Limitations

Following are the known limitations of this feature:

- Support for buffered data (data packet stream) that get deleted due to Flow Idle Timeout or other cases, is not present.

SAEGW Idle Buffering with DDN Delay and DDN Throttling Support Configuration

DDN Throttling for Release 10 Compliant MME

DDN throttling is enabled through Call Control Profile by providing the ARP value. For example, if the ARP value provided is 10, then all bearers with ARP value between 10-15 are treated as low priority bearers and are given throttling treatment. Throttling would not be enabled if ARP value is not provided through S-GW service configuration. Also, ARP IE in DDN message towards MME would not be included unless DDN throttling is configured using S-GW service. If MME is Release 10 compliant, the user need not configure the duration value as the DDN Acknowledgment would have the throttling IE. Otherwise, throttling can be enabled at S-GW by setting the duration value. If it's set to 0, S-GW would apply throttling recurringly. To enable throttling only for a given duration of time (in non Rel-10 compliant MME), user needs to set the value in hours and minutes. From the time of configuration, throttling would be applied at S-GW until the timer duration expires. For example, if user sets hours = 10, minutes = 30, S-GW would apply throttling for next 10 hours 30 minutes.

On re-configuration, all the parameters will be set with new values, but they will be applicable only from the next recalibration except from polling time and time factor.

Use the following configuration to configure DDN throttling for release 10 MME:

```
configure
  context context_name
    sgw-service service_name
      [ no ] ddn throttle arp-watermark arp_value
    end
```

NOTES:

- **arp-value:** Valid ARP value between 1 and 15. All the packets which have ARP greater than the configured values will be throttled as per the throttling factor.

DDN Throttling for non-Release 10 Compliant MME

Use the following configuration to configure DDN throttling for a non-release 10 MME:

```
configure
  context context_name
    sgw-service service_name
      ddn throttle arp-watermark arp_value [ rate-limit limit time-factor
seconds throttle-factor percent increment-factor percent [ poll-interval seconds
] throttle-time-sec seconds [ throttle-time-min minutes ] [
throttle-time-hour hour ] stab-time-sec seconds [ stab-time-min minutes ] [
stab-time-hour hour ]
      no ddn throttle
    end
```

NOTES:

- **rate-limit:** DDN permitted per second.
- **time-factor:** Time period in seconds over which SGW makes throttling decision (valid range 1-300 seconds).
- **arp-value:** Valid ARP value between 1 and 15. All the packets which have arp greater than the configured values will be throttled as per the throttling factor.
- **throttling-factor:** Percentage of DDN to be dropped upon detecting DDN surge (valid range between 1-100).
- **throttling-time-sec:** Time period in seconds over which DDN are throttled at SGW (valid range between 0-59 seconds).
- **throttling-time-min:** Time period in minutes over which DDN are throttled at SGW (valid range between 0-59 minutes).
- **throttling-time-hour:** Time period in hours over which DDN are throttled at SGW (valid range between 0-310 hours).
- **increment-factor:** Percentage value by which throttling factor is incremented dynamically, if existing throttling factor is insufficient to curb the DDN surge.
- **poll-interval:** Time in seconds (optional argument, default value = 1 second, poll interval < time-factor)
- **stab-time-sec/min/hours:** Stabilization time factor, time period over which if DDN rate returns to normal, then throttling need not be applied over entire throttling time period.

DDN throttling for non-Release-10 compliant MME makes use of existing Release-10 throttling implementation at SGW. By providing a configuration mechanism for SGW service, operator can still apply ddn throttling without needing any feedback from MME. Some salient points of this feature are described below:

1. The CLI configuration is applied per MME/S4-SGSN. Throttling parameters are tracked independently per MME/S4-SGSN.
2. On configuring this feature through CLI, demuxmgr polls each sessmgr for number of DDNs sent. By default, polling is done every second. This time interval can be changed by configuring the poll-interval time. Greater the poll interval time, lesser the number of internal messages within the chassis. However, it would take longer to detect a DDN surge.
3. By configuring time-factor, operator can specify the time interval for S-GW to apply throttling, if needed. It allows for some surge of DDNs if the net DDN rate is within specified limit over time-factor time interval. For example, time-factor= 10 seconds, ddn rate = 1000, poll interval = 2 seconds. Demux would poll each sessmgr every 2 seconds. Acceptable DDN rate limit is $1000 * 10 = 10000$ DDNs every 10 seconds. Say after 2 seconds, 4000 DDNs were sent, in that case S-GW wouldn't apply throttling till rate limit of 10000 DDNs is crossed within time period of 10 seconds. This allows for intermittent bursts of DDNs.
4. DDN rate limit is configured through CLI. For example, if DDN rate limit is 1000 and poll interval = 1 second, time-factor = 5 seconds, then acceptable rate limit is 5000 DDNs over 5 seconds. If the number of DDNs sent by S-GW is greater than 5000 after 5 seconds, demuxmgr would ask all sessmgrs to initiate throttling.
5. Percentage of DDNs to be throttled is configured through throttling-factor.

6. Operator can specify increment-factor to increment throttling factor if existing throttling factor is insufficient to curb the DDN surge. For example, if throttling-factor = 10%, ddn-rate = 1000, increment-factor=10%. Once throttling is applied, S-GW drops ~10% DDNs. However, if DDN rate is still greater than 1000, S-GW would increase throttling-factor to 20%. If this is still not sufficient, it would be incremented to 30%. After incrementing throttling factor, if number of DDNs dropped are greater than expected, throttling-factor would then be decrement by increment-factor. E.g. in this case, after increasing throttling factor to 30%, if DDNs sent is less than 1000 per second (taking time-factor and poll-interval into consideration), throttling factor would be decremented to 20. The cap for decrementing throttling-factor would be the configured value (10% in this case).
7. Operator can configure the time duration for which throttling is applicable at S-GW. This could be a large value in order of days (for example: 10 days or 240 hours). The operator has an option to stop throttling if DDN rate is well under control by configuring stabilization time factor. In such a case, DDNs won't be needlessly dropped. For example, throttling-time =10 days, stab-time = 8 hours. After S-GW starts DDN throttling, in a time span of 8 hours, DDNs sent + DDNs dropped < ddn-rate * 8 hours, throttling would be stopped.

Configuring Buffering Limit

Use the following configuration to configure the packet buffering limit:

```

configure
  active-charging service service_name
    buffering-limit { far-max-packets far_max_packets | flow-max-packets
flow_max_packets | subscriber-max-packets subscriber_max_packets }
    { default | no } buffering-limit { far-max-packets |
flow-max-packets | subscriber-max-packets }
  end

```

NOTES:

- **far-max-packets** *far_max_packets*—Specify the maximum number of packets to be buffered per FAR. *far_max_packets* must be an integer from 1 to 128.
Default value: 5 packets
- **flow-max-packets** *flow_max_packets*—Specify the maximum number of packets to be buffered per flow. *flow_max_packets* must be an integer from 1 to 255.
- **subscriber-max-packets** *subscriber_max_packets*—Specify the maximum number of packets to be buffered per subscriber. *subscriber_max_packets* must be an integer from 1 to 255.

Show Commands Input and/or Outputs

This section provides information regarding show commands and their outputs in support of the feature.

show subscribers user-plane-only-full all

The output of this command displays the following fields in support of this feature:

- buffered pkts
- buffered bytes

show user-plane-service statistics all

- buffer overflow drop pkts
- buffer overflow drop bytes

show user-plane-service statistics all

The following is a sample output of this command that displays statistics related to buffering:

```
[local]qnpc-si# show user-plane-service statistics all
...
Data Statistics Related To Buffering:
  Packets Buffered:                0      Bytes Buffered:                0
  Packets Discarded:               0      Bytes Discarded:               0
  Packets Dropped per FAR (<=9)    0      Packets Dropped per FAR (10-19) 0
  Packets Dropped per FAR (20-29)  0      Packets Dropped per FAR (30-39) 0
  Packets Dropped per FAR (40-49)  0      Packets Dropped per FAR (>=50)  0
...
```



CHAPTER 79

Secondary RAT Usage Report in CDR Records

- [Revision History, on page 703](#)
- [Feature Description, on page 703](#)
- [Configuring Secondary RAT Usage Report through GTPP, on page 707](#)
- [Monitoring and Troubleshooting, on page 710](#)

Revision History

Revision Details	Release
Support for "Secondary RAT Usage Report in CDR Records" feature has been added in this release as well.	21.20.31
Support for "Secondary RAT Usage Report in CDR Records" feature has been added in this release as well.	21.26
First introduced	21.23.14

Feature Description

Reporting issues pertaining to 5G **RANSecondaryRATUsageReport** occur due to lack of:

- Control in identifying whether the **RANSecondaryRATUsageReport** must be processed in CDRs or not. This allows the S-GW, P-GW, and SAEGW to either include these reports in the SGW-CDR or PGW- CDR or to simply ignore them.
- Number of available reports inside a CDR, if the control is active.
- Control in identifying whether Zero-volume reports must make it inside the CDR or not.

This results in billing loss of data. To overcome these reporting issues, you can trigger CLI controls using GTPP group configuration to:

- Allow the S-GW, P-GW, and SAEGW to either include the RANSecondary RAT Usage reports in the SGW-CDR or PGW-CDR or to simply ignore them.

- Identify the number of secondary RAT usage reports available inside the SGW-CDR or the PGW- CDR.



Note This limit must be in accordance with the system capability and ensure to consider the File-Format of the CDRs. If the configured limit exceeds, the system closes the SGW-CDR or PGW-CDR with the appropriate change-condition. For example, **max-change-condition** CDR is reused for further reports.

- Add or ignore Zero-volume reports inside the CDR.
- The CLI **gtp limit-secondary-rat-usage** or hardcoded limit will be removed and the CLI **gtp limit-secondary-rat-usage** is reused to control the number of records within the range 1-100.
- Provides logging when the CDR size reaches the maximum size. Through PGW-CDR counter, you can monitor the number of occurrences when the CDR exceeds its size limit.

Behavior Matrix

The following table explains the new behavior of P-GW and S-GW for this feature.

CLI	P-GW New Behavior	S-GW New Behavior
gtp attribute secondary-rat-usage By default this CLI command is enabled in gtp group.	P-GW sends secondary RAT usage records in CDR including zero volume records.	S-GW sends secondary RAT usage records in CDR including zero volume records.
[no] gtp attribute secondary-rat-usage	P-GW does not send secondary RAT usage records in CDR.	S-GW does not send secondary RAT usage records in CDR.
gtp suppress-secondary-rat-usage zero-volume By Default, this CLI command is disabled in gtp group.	P-GW does not include and send zero volume secondary RAT records in CDR. P-GW sends only secondary RAT records that is having non-zero volumes.	S-GW does not include and send zero volume secondary RAT records in CDR. S-GW sends only secondary RAT records that is having non-zero volumes.
[no] gtp suppress-secondary-rat-usage zero-volume	P-GW sends secondary RAT usage records including zero volume records in CDR.	S-GW sends secondary RAT usage records including zero volume records in CDR.

CLI	P-GW New Behavior	S-GW New Behavior
<p>gtp limit-secondary-rat-usage range_1-100. If not configured, the default value is 32. By default this CLI command is enabled in gtp group.</p> <p>Example: gtp limit-secondary-rat-usage 32</p> <p>Note This CLI is the modification of the existing CLI command gtp limit-secondary-rat-usage with range between 1– 100.</p>	<p>PGW generates CDR immediately when total received secondary RAT records exceeds 32 and reported cause value is <i>maximum change condition</i>.</p> <p>P-GW generates multiple CDRs if total received secondary RAT records are multiples of 32.</p> <p>Example: If P-GW receives 100 RAT records between two triggers, PGW generates 3 CDRs and keeps the remaining 4 RAT records for the next CDR trigger.</p>	<p>S-GW generates CDR immediately when total received secondary RAT records exceeds 32 and the reported cause value is <i>maximum change condition</i>.</p> <p>S-GW generates multiple CDRs if the total received secondary RAT records are multiples of 32.</p> <p>Example: If S-GW receives 100 RAT records between two triggers, S-GW generates 3 CDRs and keeps the remaining 4 RAT records for the next CDR trigger.</p>
<p>Example:gtp limit-secondary-rat-usage 40</p>	<p>P-GW generates CDR immediately when total received secondary RAT records exceeds 40 and cause value is <i>maximum change condition</i>.</p> <p>P-GW generates multiple CDRs if total received secondary RAT records are multiples of 40.</p> <p>Example: If P-GW receives 100 RAT records between two triggers, it will generate 2 CDRs and will keep remaining 20 RAT records for the next CDR trigger.</p>	<p>If the configured value is greater than 32 and sends 32 secondary RAT records in every CDR, Ignores gtp limit-secondary-rat-usage 40 CLI command.</p>
<p>Example:gtp limit-secondary-rat-usage 20</p>	<p>P-GW generates CDR immediately when total received secondary RAT records exceed 20 and cause value is <i>maximum change condition</i>.</p> <p>P-GW generates multiple CDRs if total received secondary RAT records are multiples of 20.</p> <p>Example: If P-GW receives 100 RAT records between two triggers, P-GW generates 2 CDRs and will store the remaining 20 RAT records for next CDR trigger.</p>	<p>S-GW generates CDR immediately when the total received secondary RAT records exceeds 20 and cause value is <i>maximum change condition</i>.</p> <p>S-GW generates multiple CDRs if total received secondary RAT records are in multiples of 20.</p> <p>Example: If S-GW receives 100 RAT records between two triggers, it will generate 5 CDRs.</p>

CLI	P-GW New Behavior	S-GW New Behavior
[no] gtp limit-secondary-rat-usage	<p>Generates CDR immediately when the total received secondary RAT records exceed 255 and cause value is <i>maximum change condition</i>.</p> <p>Generates multiple CDRs if the total received secondary RAT records are multiples of 255.</p> <p>Example: If 1000 RAT records between two triggers are received, then 3 CDRs are generated. The remaining 235 RAT records are stored for the next CDR trigger.</p>	<p>Ignores the [no] gtp limit-secondary-rat-usage CLI and sends 32 secondary RAT records in every CDR.</p> <p>Behavior is similar to the gtp limit-secondary-rat-usage 32 CLI implementation.</p> <p>Counter and debug logs are not required as it will never exceed the CDR size of 64k.</p>
	Service specific Unit Limit is sending in serviceConditionChange file	Record Closure

Relationship to Other Features

- Sessmgr Restart While Processing Secondary RAT Usage CDR Records in the *P-GW Administration Guide*.
- Secondary RAT Usage IE during GnGp handover, S-GW, and P-GW support of Secondary RAT Data Usage Report in Gz CDRs, see the *5G Non-Standalone* chapter in the *P-GW Administration Guide*.
- P-GW support of Secondary RAT Data Usage Report in Rf CDRs, see the *5G Non-Standalone* chapter in the *P-GW Administration Guide*.

Limitations

This feature has the following limitations:

- Only 16 secondary RAT records per bearer are recovered for S-GW during session recovery. S-GW allows checkpointing of a maximum number of 16 secondary RAT records per bearer.
- A maximum of 142 secondary RAT records across all bearers is recovered for P-GW during session recovery. P-GW allows checkpointing of a maximum number of 142 secondary RAT records across all bearers.
- Anything beyond these numbers gets lost during session recovery.

Configuring Secondary RAT Usage Report through GTPP

Use the following GTPP configurations to close Secondary RAT Usage CDR records before exceeding a buffer size.

Enabling or Disabling the Secondary RAT Usage Report

Use the following configuration to enable or disable secondary RAT Usage report.

```
configure
context context_name
  gtp group group_name
    gtp attribute secondary-rat-usage
  default gtp attribute secondary-rat-usage
  no gtp attribute secondary-rat-usage
end
```

NOTES:

- **gtp attribute secondary-rat-usage:** Sends an optional attribute Secondary RAT usage records.
- **default gtp attribute secondary-rat-usage:** Sends an optional attribute Secondary RAT usage records by default.
- **no gtp attribute secondary-rat-usage:** Does not send the optional attribute Secondary RAT usage records.

Controlling the Maximum Number of Entries

When the Secondary RAT usage record reaches the maximum configured value within a CDR, the CDR closure cause occurs and uses **maxChangeCond**. The **gtp limit-secondary-RAT-usage** CLI command controls the maximum number of Secondary RAT usage record entries in the P-GW and S-GW CDRs. If the limit is configured with a value more than 32, the partial CDRs get generated with a maximum of 32 for S-GW CDR.



Note The existing behaviour of S-GW has a limit of 32 Secondary RAT Usage records.

The following table explains the behavior of Secondary RAT records and CDR, and the maximum limit.

SI. Number	CDR Type	Configured limit-secondary-rat-usage	Effective Maximum Limit	No. of Secondary RAT records Sent by UE	Behavior of Secondary RAT Records and CDR
1	P-GW	Less than 32 Example: 20	20	35	Partial CDR is generated with 20 secondary RAT records.
					Remaining 15 secondary RAT records sent in the next trigger.
	S-GW	Less than 32 Example: 20	20	35	Partial CDR is generated with 20 Secondary RAT records.
					Remaining 15 Secondary RAT records sent in the next trigger.
2	P-GW	32	32	35	Partial CDR is generated with 32 Secondary RAT records.
					Remaining 3 secondary RAT records sent in the next trigger.
	S-GW	32	32	35	Partial CDR is generated with 32 secondary RAT records.
					Remaining 3 secondary RAT records sent in the next trigger.

SI. Number	CDR Type	Configured limit-secondary-rat-usage	Effective Maximum Limit	No. of Secondary RAT records Sent by UE	Behavior of Secondary RAT Records and CDR
3	P-GW	Greater than 32 Example: 100	100	100	Partial CDR is generated with 100 secondary RAT records.
	S-GW	Greater than 32 Example: 100	32	100	Three partial CDRs are generated with 32 secondary RAT records each. Remaining 4 secondary RAT records sent in the next trigger.
4	P-GW	Not configured	255	1000	Three partial CDRs are generated with 255 secondary RAT records each. Remaining reported Secondary RAT records become a part of CDR in the next trigger.
	S-GW	Not configured	32	1000	No partial CDR is generated. 32 Secondary RAT records become part of the CDR in the next trigger.

Use the following configuration to control the maximum number of entries.

```

configure
context context_name
  gtpv group group_name
    gtpv limit-secondary-rat-usage usage_limit
  default gtpv limit-secondary-rat-usage

```

```
no gtp limit-secondary-rat-usage
end
```

NOTES:

- **gtp limit-secondary-rat-usage *usage_limit***: Enter a maximum number of secondary RAT reports. *usage_limit* must be an integer in the range of 1-100. The recommended value for S-GW CDR is 32. For example, if the limit is set to 10, then the CDR is generated once the configured value is reached.
- **default gtp limit-secondary-rat-usage**: Specifies a default value of 32.
- **no gtp limit-secondary-rat-usage**: Disables the CDR generation with limited number of secondary RAT usage information.

Suppressing Zero-Volume Secondary RAT Usage Report

Use the following configuration to suppress zero-volume Secondary RAT Usage report.

```
configure
context context_name
  gtp group group_name
    gtp suppress-secondary-rat-usage zero-volume
  default gtp suppress-secondary-rat-usage zero-volume
  no gtp suppress-secondary-rat-usage zero-volume
end
```

NOTES:

- **gtp suppress-secondary-rat-usage zero-volume**: Suppresses either Secondary RAT records or zero volume Secondary RAT records.
- **default gtp suppress-secondary-rat-usage zero-volume**: Does not suppress the zero volume secondary RAT usage records.
- **no gtp suppress-secondary-rat-usage zero-volume**: Does not suppress the zero volume Secondary RAT usage records.

Monitoring and Troubleshooting

This section provides information on how to monitor and troubleshoot using show commands available in support of this feature.

Show Commands and Outputs

This section provides information regarding show commands and their outputs for this feature.

show config

The output of this CLI command displays the following parameters.

Field	Description
gtpp attribute secondary-rat-usage	Specify this option to include the Secondary RAT reports field in the CDR.
gtpp suppress-secondary-rat-usage zero-volume	Enables the exclusion of the zero volume Secondary RAT reports in the CDR.
gtpp limit-secondary-rat-usage	Enables limiting the number of Secondary RAT Usage reports in CDR with the configured value.

show config verbose

The output of this CLI command displays the following parameters.

Field	Description
gtpp attribute secondary-rat-usage	Displays the Secondary RAT usage records.
gtpp suppress-secondary-rat-usage zero-volume	Displays only Secondary RAT records that is having non-zero volumes from P-GW and S-GW.
gtpp limit-secondary-rat-usage	If total received Secondary RAT records are multiples of 10, displays multiple CDR generated by P-GW and S-GW. The reported cause value will be the maximum change condition.
no gtpp limit-secondary-rat-usage	Displays Secondary RAT records for unconfigured cause.

show gtpp group

The output of this CLI command displays the following parameters.

Field	Description
Secondary RAT records present	Specifies whether the Secondary RAT record is present or not. The available options are: <ul style="list-style-type: none"> • no • yes
Limit-secondary-rat-usage	Specifies a limit for Secondary RAT usage report.

show gtpp statistics group

The output of this CLI command displays the following parameter.

Field	Description
Total PGW-CDR exceed size limit	Displays the total number of CDRs that exceeded size limit in P-GW.

show gtp statistics group



CHAPTER 80

Secondary RAT Usage During GnGp Handover

- [Revision History, on page 713](#)
- [Feature Description, on page 713](#)
- [Configuring Secondary RAT Usage during GnGp Handover, on page 715](#)

Revision History



Note Revision history details are not provided for features introduced before release 21.24.

Revision Details	Release
First introduced	Pre 21.24

Feature Description

The feature supports the Secondary RAT Usage IE reported in change notification request during 4G to 3G handover (GnGp). The functionality mentioned in Step 13 of the following call flow is added as part of this feature. The usage is reported in next CDR generation.

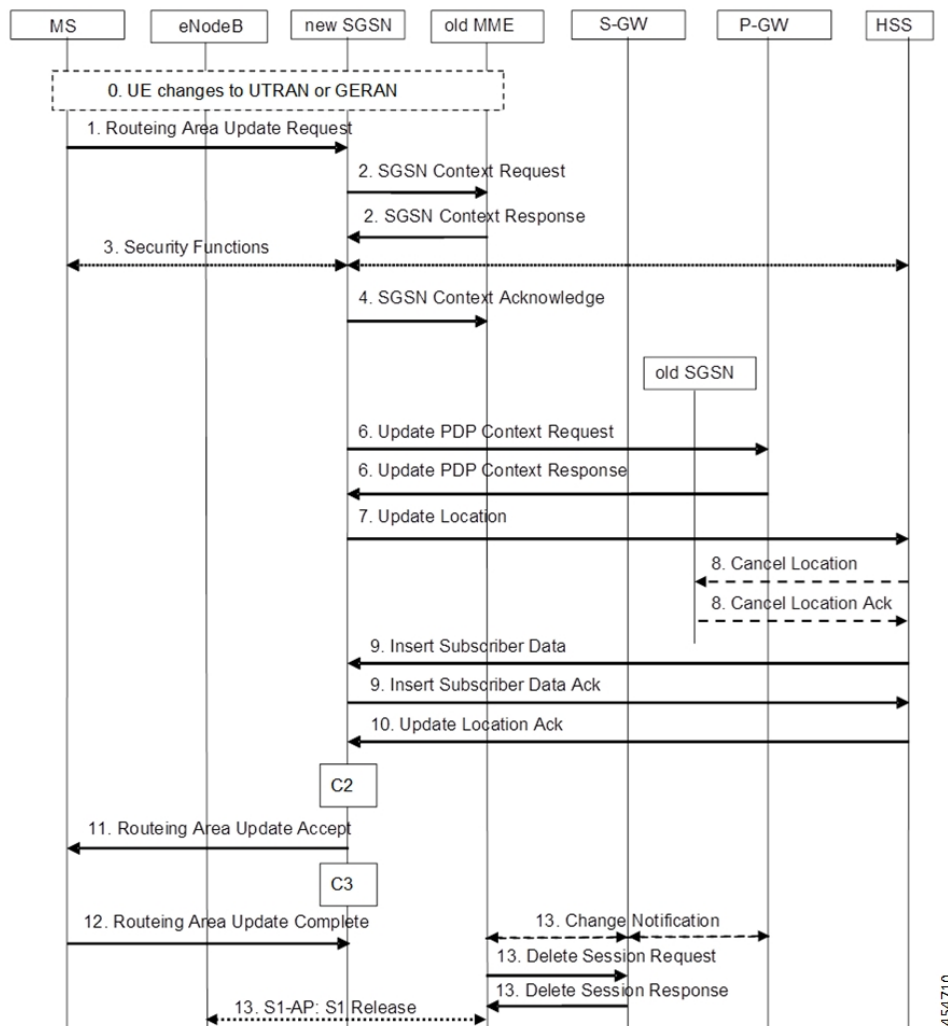

IMSI Not Known

If there's no context found for IMSI specified in Secondary RAT Usage IE of change notification request message, it returns the change notification response with cause value "IMSI/IMEI not known".

Limitation

The following are the known limitations of this feature:

- This feature supports only handling of the Secondary RAT Usage IE.
- As 3G releases dedicated bearer during 4G to 3G handover in CUPS, it ignores the Secondary RAT Usage for dedicated bearer reported after release of the same.

Configuring Secondary RAT Usage during GnGp Handover

This sections provides information about the CLI commands available in support of the feature.

Enabling Secondary RAT Data Usage Report

Use the following configuration to enable Secondary RAT Data Usage Report:

```
configure
  context context_name
    pgw-service service_name
      dcnr
    end
```



Note The GGSN service associated with P-GW service must have the DCNR enabled using this configuration.



CHAPTER 81

Self-overload Detection and Admission Control of Sx at UP

- [Revision History, on page 717](#)
- [Feature Description, on page 717](#)
- [Configuring Overload Control at User Plane, on page 718](#)
- [Monitoring and Troubleshooting, on page 720](#)

Revision History



Note Revision history details are not provided for features introduced before release 21.24.

Revision Details	Release
First introduced	Pre 21.24

Feature Description

Overload detection and control at User Plane (UP) is implemented using the eMPS functionality. During an overload scenario at Sx, the Session Establishment and Modification requests that are received at Sx (UP) are rejected for all non-eMPS subscribers.

Currently, overload control is supported for Sx Control Plane (CP). To support eMPS at UP, the CP adds the eMPS value to Message Priority IE in the PFCP header and sends the message over to UP.

The UP, on receipt of the Sx Session Establishment/Modification request, performs an overload check. If the detected system load is normal, the session establishment/modification is allowed, and the session is marked as a priority session based on the MP flag set in the PFCP header.

If the detected system load is overloaded, the Sx Session Establishment/Modification is rejected for all eMPS subscribers.

The system load level is determined by the following factors:

- System Utilization (CPU, Memory, and Licenses)

- Session Manager Utilization (CPU and Memory)
- VPP-CPU Utilization

Limitations

The following are the known limitations of the feature:

- Data throttling is not supported.
- Alarms are not supported.
- Bulk statistics are not supported.
- No support for handling APN-based emergency calls in a Pure-S scenario. Other emergency calls such as – IMSI-based and IMEI-valid based are handled.
- Only self-overload protection is supported in this release.
- User Plane ICSR not supported in this release.
- Impact on existing calls: If **userplane-overload-control-profile** is configured and associated to user plane service. Also, if the system moves to overload condition and the user plane service rejects SX Session Establishment and SX session modification messages, this leads to call cleanup/drop of relevant calls triggering SX session modification messages. This behavior continues until the system returns to the normal load condition.

Configuring Overload Control at User Plane

eMPS Profile Creation and Association to S-GW and P-GW Services of Control Plane



Important This configuration must be done before configuring an overload control profile at UP.

```

configure
  emps-profile profile_name
    earp earp_value
  end
configure
  context context_name
    sgw-service service_name
      associate emps-profile profile_name
    exit
    pgw-service service_name
      associate emps-profile profile_name
    end

```

Configuring the Overload Control Profile at UP

Use the following commands to configure overload control profile.

```
configure
  userplane-overload-control-profile profile_name
end
```

Configuring Overload Threshold Parameters

Use the following commands to configure overload threshold parameters.

```
configure
  userplane-overload-control-profile profile_name
    overload-threshold system lower-limit limit_value upper-limit limit_value
  sessmgr lower-limit limit_value upper-limit limit_value vpp-cpu lower-limit
  limit_value upper-limit limit_value
end
```

NOTES:

- **overload-threshold:** Configures Overload thresholds limits for system, sessmgr and vpp-cpu.
- **system:** Configures overload system threshold after which node moves to self-protection mode.
- **vpp-cpu:** Configures the overload vpp-cpu threshold after which node moves to self-protection mode.
- **sessmgr:** Configures the overload threshold for session manager after which node moves to self-protection mode.
- **upper-limit *limit_value*:** Configures overload vpp-cpu threshold L2 after which node moves to self-protection mode. Default limit value is 60%.
- **lower-limit *limit_value*:** Configures overload vpp-cpu threshold L1 after which node moves to self-protection mode. Default limit value is 50%.

Configuring System Weightage Parameters

Use the following commands to configure session manager weightage parameters.

```
configure
  userplane-overload-control-profile profile_name
    system-weightage system-cpu-utilization utilization_value
  system-memory-utilization utilization_value license-session-utilization
  utilization_value
end
```

NOTES:

- **system-weightage:** Configures system weightage for various overload control parameters. Total weightage of all the parameters should be 100. The default values are 40% weightage to system-cpu-utilization, 30% weightage to system-memory-utilization and 30% weightage to license-session-utilization.
- **system-cpu-utilization:** Configures system CPU utilization weightage in percentage. Default weightage in overload factor is 40%.

- **system-memory-utilization**: Configures system memory utilization weightage in percentage. Default weightage in overload factor is 30%.
- **license-session-utilization**: Configures license session utilization weightage for User Plane service in percentage. Default weightage in overload factor is 30%.

Configuring Session Manager Weightage Parameters

Use the following commands to configure session manager weightage parameters.

```
configure
  userplane-overload-control-profile profile_name
    sessmgr-weightage sessmgr-cpu-utilization utilization_value
  sessmgr-memory-utilization utilization_value
end
```

NOTES:

- **sessmgr-weightage**: Configures sessmgr weightage for various overload control parameters. Total weightage of all the parameters should be 100. The default values are 35% weightage to sessmgr-cpu-utilization and 65% weightage to sessmgr-memory-utilization.
- **sessmgr-cpu-utilization**: Configures session manager CPU utilization weightage in percentage. Default weightage in overload factor is 35%.
- **sessmgr-memory-utilization**: Configures session manager memory utilization weightage in percentage. Default weightage in overload factor is 65%.

Associating an Overload Control Profile with a User Plane Service

Use the following commands to associate the Overload Control profile to a use plane service.

```
configure
  context context_name
    user-plane-service service_name
    [ no ] associate userplane-overload-control-profile profile_name
```

NOTES:

- **associate**: This command associates the user plane overload control profile with a user plane service.

Monitoring and Troubleshooting

Show Commands Input and/or Outputs

This section provides information regarding show commands and their outputs in support of the feature.

show user-plane-service name *name*

The following fields are displayed in support of this feature:

- Service name
 - Service-Id
 - Context
 - Status
 - PGW Ingress GTPU Service
 - SGW Ingress GTPU Service
 - SGW Egress GTPU Service
 - Control Plane Tunnel GTPU Service
 - Sx Service
 - Control Plane Group
 - Userplane Overload Control Profile
 - Fast-Path service

show user-plane-service statistics name *user_plane_service_name*

The following fields are displayed in support of this feature:

- Overload Control Information
 - Current Overload Factor System: Average of all user plane service values
 - Current Overload Factor SessMgr
 - Current Overload Factor VPP-CPU
 - No of times Overload Threshold Reached
 - No of Session Establishment Req rejected during overload
 - No of Session Modif Req rejected during overload
 - No of eMPS Session Establishment Req allowed during overload
 - No of eMPS Session Modif Req allowed during overload

show userplane-overload-control-profile name *name*

The following fields are displayed in support of this feature:

- User Plane Overload Control Profiles
- User Plane Overload Control Profile Name
- System Weightage and Thresholds:
 - CPU Utilization Weightage
 - Memory Utilization Weightage

show userplane-overload-control-profile name name

- License Session Utilization Weightage
- System Threshold Lower Limit
- System Threshold Upper Limit
- Sessmgr Weightage and Thresholds:
 - CPU Utilization Weightage
 - Memory Utilization Weightage
 - Sessmgr Threshold Lower Limit
 - Sessmgr Threshold Upper Limit
- VPP Weightage and Thresholds:
 - VPP Utilization Weightage
 - vpp-cpu Threshold Lower Limit
 - vpp-cpu Threshold Upper Limit



CHAPTER 82

Smart Licensing

- [Revision History](#), on page 723
- [Overview](#), on page 723
- [Configuring Smart Licensing](#), on page 728
- [Monitoring and Troubleshooting Smart Licensing](#), on page 729

Revision History



Note Revision history details are not provided for features introduced before release 21.24.

Revision Details	Release
First introduced	Pre 21.24

Overview

Ultra Packet Core CUPS supports Smart Licensing. Smart Licensing is a cloud-based approach to licensing that simplifies the purchase, deployment, and management of Cisco software assets. Entitlements are purchased through your Cisco account via Cisco Commerce Workspace (CCW) and immediately deposited into your Virtual Account for usage. This eliminates the need to install license files on every device. Products that are smart-enabled, communicate directly to Cisco to report consumption. A single location is available to customers to manage Cisco software licenses—the Cisco Smart Software Manager (CSSM). License ownership and consumption are readily available to help make better purchase decision based on consumption or business need.

See <https://www.cisco.com/c/en/us/buy/smart-accounts/software-licensing.html> for more information about Cisco Smart Licensing.

Comparison Between Legacy Licensing and Smart Licensing

Cisco employs two types of license models - Legacy Licensing and Smart Software Licensing. **Legacy Licensing** consists of software activation by installing Product Activation Keys (PAK) on to the Cisco product. A Product Activation Key is a purchasable item, ordered in the same manner as other Cisco equipment and

used to obtain license files for feature set on Cisco Products. **Smart Software Licensing** is a cloud-based licensing of the end-to-end platform leveraging few tools that authorize and deliver license reporting. Smart Software Licensing functionality incorporated into StarOS completes the product registration, authorization resulting in reporting services available to the end customer.

Evaluation Period

A 90-day evaluation period is granted for all licenses in use. During this period, feature licenses can be used without limitation, and up to one counting license each can be used. The evaluation period ends when the system registers successfully with the CSSM or Cisco.com. Licensed functionality is blocked when this 90-day period expires.

CUPS performs license enforcement for on/off feature licenses. Each on/off feature license is tied to service licenses, which potentially use those on/off features. When an Out of Compliance (OOC) is detected for an on/off license, new calls for the corresponding services will be dropped, subject to the following conditions:

- Each on/off feature license is given a 90-day grace (evaluation) period. During this period, the system generates SNMP traps to inform of the unavailability of valid licenses. To resolve the OOC, corrective action is needed such as purchasing and registering licenses for this feature, or disabling the feature.
- If the feature is still OOC after the 90-day grace period, CUPS enforces the OOC state based on a predefined policy for each license. If enforcement is required, new calls for the services corresponding to the on/off licenses are dropped.

The following CLI commands can be used to display details about the enforcement of Smart Licenses in use:

```
show license enforcement policy
show license enforcement status [ allowed | blocked ] [ feature | service
]
```

Cisco Smart Software Manager

Cisco Smart Software Manager (CSSM) enables the management of software licenses and Smart Account from a single portal. The interface allows you to activate your product, manage entitlements, and renew and upgrade software. A functioning Smart Account is required to complete the registration process. To access the Cisco Smart Software Manager, see <https://software.cisco.com>.

Smart Accounts/Virtual Accounts

A Smart Account provides a single location for all Smart-enabled products and entitlements. It helps speed procurement, deployment, and maintenance of Cisco Software. When creating a Smart Account, you must have the authority to represent the requesting organization. After submitting, the request goes through a brief approval process.

A Virtual Account exists as a sub-account within the Smart Account. Virtual Accounts are a customer-defined structure based on organizational layout, business function, geography or any defined hierarchy. They are created and maintained by the Smart Account administrator.

See <https://software.cisco.com> to learn about, set up, or manage Smart Accounts.

Smart Licensing Mode

The Smart Licensing Mode is categorized as follows:

- **Reporting Licenses (Parent Licenses):** The Parent Licenses are reported to backend license server (CSSM) and accounted for usage of licenses. For each Parent Licenses, the entitlement tags are created and the same is used to identify the type service or feature.
- **Non-Reporting Licenses (Child Licenses):** The Child Licenses are not reported to backend license server (CSSM) and these licenses are enabled by default with the Parent Licenses. For Child Licenses, the entitlement tags are not created.

That is to say, Smart License enables all Parent and Child Licenses based on the Product Type that is configured. However, the reporting is done only for Parent Licenses.

The state of Smart Licensing Agent is persistent across reboot and crashes.

Request a Cisco Smart Account

A Cisco Smart Account is an account where all products enabled for Smart Licensing are deposited. A Cisco Smart Account allows you to manage and activate your licenses to devices, monitor license use, and track Cisco license purchases. Through transparent access, you have a real-time view into your Smart Licensing products. IT administrators can manage licenses and account users within your organization's Smart Account through the Smart Software Manager.

-
- Step 1** In a browser window, enter the following URL:
- ```
https://software.cisco.com
```
- Step 2** Log in using your credentials, and then click **Request a Smart Account** in the **Administration** area. The **Smart Account Request** window is displayed.
- Step 3** Under **Create Account**, select one of the following options:
- **Yes, I have authority to represent my company and want to create the Smart Account** – If you select this option, you agree to authorization to create and manage product and service entitlements, users, and roles on behalf of your organization.
  - **No, the person specified below will create the account** – If you select this option, you must enter the email address of the person who will create the Smart Account.
- Step 4** Under **Account Information**:
- a) Click **Edit** beside **Account Domain Identifier**.
  - b) In the **Edit Account Identifier** dialog box, enter the domain, and click **OK**. By default, the domain is based on the email address of the person creating the account and must belong to the company that will own this account.
  - c) Enter the **Account Name** (typically, the company name).
- Step 5** Click **Continue**.  
The Smart Account request will be in pending status until it has been approved by the Account Domain Identifier. After approval, you will receive an email confirmation with instructions for completing the setup process.
- 

## Software Tags and Entitlement Tags

Tags for the following software and entitlements have been created to identify, report, and enforce licenses.

## Software Tags

Software tags uniquely identify each licenseable software product or product suite on a device. The following software tags exist for CUPS.

| Product Type / Description         | Software Tag                                                                 |
|------------------------------------|------------------------------------------------------------------------------|
| CUPS_CP<br>4G CUPS - Control Plane | regid.2020-08.com.cisco.CUPS_CP,<br>1.0_7afd7a3c-38dd-4a04-aecc-26df25029649 |
| CUPS_UP<br>4G CUPS - User Plane    | regid.2020-08.com.cisco.CUPS_UP,<br>1.0_fd28551c-a541-4902-87af-bba2d6b33cf1 |

## Reporting (Parent) Entitlement Tags for CUPS\_CP

The following entitlement tags identify licenses in use for each product type.

| License Display Name/Description                   | Entitlement Tag                                                                               | License Type | Reporting Slab | Tag Name             |
|----------------------------------------------------|-----------------------------------------------------------------------------------------------|--------------|----------------|----------------------|
| 4G CUPS CP 1K<br>4G CUPS Control Plane 1K Sessions | regid.2020-08.com.cisco.<br>L_CUPS_CP_SAE_1K,<br>1.0_a84e70b6-d3f9-41c9<br>-8449-4b7bb7426b30 | Counting     | 1K             | L_CUPS_CP_<br>SAE_1K |

## Reporting (Parent) Entitlement Tags for CUPS\_UP

The following entitlement tags identify licenses in use for each product type.

| License Display Name/Description                     | Entitlement Tag                                                                               | License Type | Reporting Slab | Tag Name              |
|------------------------------------------------------|-----------------------------------------------------------------------------------------------|--------------|----------------|-----------------------|
| 4G CUPS UP 1K<br>4G CUPS User Plane 1K Sessions      | regid.2020-08.com.cisco.<br>L_CUPS_UP_SAE_1K,<br>1.0_41005ab7-1ad0-46ac<br>-905b-c3c5ed402981 | Counting     | 1K             | L_CUPS_UP_<br>_SAE_1K |
| 4G CUPS UP Instances<br>4G CUPS User Plane Instances | regid.2020-08.com.cisco.<br>F_CUPS_UP_INS,<br>1.0_897c46a0-04b5-4fdb<br>-bedd-9d5fb75bdb76    | On/Off       | 1/0            | F_CUPS_UP_INS         |

## Non-reporting (Child) License List

In this release, the following Child Licenses are enabled by default when the Parent Licenses are enabled.

| License Description | License Type |
|---------------------|--------------|
| PGW 1k Sessions     | Counting     |
| SGW 1k Sessions     | Counting     |
| GGSN 1k Sessions    | Counting     |

| License Description                                            | License Type |
|----------------------------------------------------------------|--------------|
| Per Subscriber Stateful Firewall 1k Sessions                   | Counting     |
| ENAT 1k Sessions                                               | Counting     |
| Enhanced Charging Bundle 1                                     | Counting     |
| Enhanced charging bundle 2                                     | On/Off       |
| Dynamic policy interface                                       | On/Off       |
| Enhanced LI service                                            | On/Off       |
| Lawful intercept                                               | On/Off       |
| Session recover                                                | On/Off       |
| Radius AAA server group                                        | On/Off       |
| IPv6                                                           | On/Off       |
| Intelligent Traffic Control                                    | On/Off       |
| DIAMETER Closed-Loop Charging Interface                        | On/Off       |
| Per-Subscriber Traffic Policing/Shaping                        | On/Off       |
| Dynamic Radius extensions (CoA and PoD)                        | On/Off       |
| Proxy MIP                                                      | On/Off       |
| FA                                                             | On/Off       |
| IPSec                                                          | On/Off       |
| Inter-Chassis Session Recovery                                 | On/Off       |
| ICSR/SR Performance Improvements                               | On/Off       |
| ICSR Enhanced Recovery for Data and Control Plane, 1K Sessions | On/Off       |
| MPLS                                                           | On/Off       |
| TACACS+                                                        | On/Off       |
| NAT/PAT With DPI                                               | On/Off       |
| Rate Limiting Function (Throttling)                            | On/Off       |
| Overcharging Protection for EPC-GW                             | On/Off       |
| Overcharging Protection Upgrade for EPC-GW                     | On/Off       |
| ADC Trigger Over Gx, 1K Sessions                               | On/Off       |
| Gx Based Virtual APN Selection, 1K Sessions                    | On/Off       |
| EPC-GW Support for Wi-Fi Integration, 1K Sessions              | On/Off       |
| EPC-GW Non-Standard QCI Support, 1K Sessions                   | On/Off       |
| Local Policy Decision Engine                                   | On/Off       |
| Header Enrichment                                              | On/Off       |

| License Description                                   | License Type |
|-------------------------------------------------------|--------------|
| HTTP Header Encryption                                | On/Off       |
| HTTP Header Enrichment and Encryption                 | On/Off       |
| Broadcast & Multicast Services                        | On/Off       |
| Integrated Content Filtering Provisioned Service      | On/Off       |
| Application Detection and Control 1k Sessions         | Counting     |
| 5G NSA Feature Set 100K Sess VPCSW Active 1k Sessions | Counting     |
| 5G NSA Enablement Fee, Network Wide                   | On/Off       |
| Multimedia Priority Service Feature Set, 1K Sessions  | On/Off       |
| EPC Gw VoLTE enhancements                             | On/Off       |
| DNS Snooping                                          | On/Off       |

## Configuring Smart Licensing

Before you begin, ensure you have:

- Created a Smart Licensing account on <https://software.cisco.com>.
- Registered your products on <https://software.cisco.com> using the Product Instance Registration tokens created as part of Smart Account/Virtual Account.
- Enabled a communication path between the StarOS system to the CSSM server or Cisco.com.

### Enable Smart Licensing

By default, Smart Licensing is disabled in CUPS. To enable Smart Licensing, enter the following Config mode commands:

```
configure
 license smart product { cups-cp | cups-up }
 license smart enable
end
```

**NOTE:** Before enabling Smart Licensing, Product Type must be configured to enable default licenses that are based on product type.

Enter the following command to verify the configuration:

```
show configuration | grep license
```

### Register the Device with Cisco

Using the Product Instance Registration token ID provided when you registered the products on <https://software.cisco.com>, register the system using the following Exec mode command:

```
license smart register idtoken token
```

The system now automatically reports entitlement usage count to the CSSM server and receives a compliance status. This also removes the system from "Evaluation Mode".

To show the compliance status, enter any of the following Exec mode commands:

```
show license status
show license summary
show license statistics
```

The registration for the system is renewed automatically every 180 days. If needed, use the following Exec mode command to renew the registration information manually:

```
license smart renew id
```

The license authorization for the system is renewed automatically every 30 days. If needed, use the following Exec mode command to renew the license authorization manually:

```
license smart renew auth
```

To unregister a device, enter the following Exec mode command:

```
license smart deregister
```

### Changing Smart Transport URL

Smart Agent uses Smart Transport to communicate to Cisco CSSM server. Smart Transport uses the configured URL to identify destination URL where CSSM is reachable. This will not initiate any communication with Cisco. If needed, enter the following Configuration mode commands:

```
configure
 license smart transport smart
 license smart url https_link
```

### Handling Out of Compliance

If there are not enough licenses in the virtual account for a given SKU, CSSM sends an Out Of Compliance (OOC) message to the device. The system stops allowing additional sessions until the OOC state is cleared. The OOC state is cleared when the device receives an authorized response.

## Monitoring and Troubleshooting Smart Licensing

Enter the following Exec mode command to verify the Smart Licensing configuration:

```
show configuration | grep license
```

The following Exec mode commands display information about Smart Licensing:

```
show license { all | enforcement | smart-tags | statistics | status |
summary | tech-support | udi | usage }
```

#### NOTES:

- **all** - Shows a superset of information that includes show status, show usage, show UDI, as well as the Smart Licensing agent version.
- **enforcement { policy | status [ allowed | blocked ] [ feature | service ] }** - Shows the enforcement policy applied or current enforcement status of Smart Licenses. Status information can be filtered to

show only the licenses which are currently allowed or blocked, or by type (feature license or service license).

- **smart-tags [ feature | service ]** - Shows the features and services that are currently supported and the corresponding Smart Entitlement Tag.
- **statistics [ verbose ]** - Shows individual feature license status.
- **status** - Shows overall Smart Licensing status information.
- **summary** - Shows summary of Smart Licensing status.
- **tech-support** - Shows information useful for debugging issues with Smart Licensing.
- **udi** - Shows details for all Unique Device Identifiers (UDI).
- **usage** - Shows the usage information for all entitlements that are currently in use.





# CHAPTER 83

## Software Management Operations

- [Revision History, on page 731](#)
- [Overview, on page 731](#)
- [Upgrading or Downgrading of CP and UP, on page 733](#)

### Revision History



**Note** Revision history details are not provided for features introduced before release 21.24.

| Revision Details                                                         | Release   |
|--------------------------------------------------------------------------|-----------|
| Support is extended for N-4 backward compatibility of software releases. | 21.26     |
| Support is extended for N-3 backward compatibility of software releases. | 21.25     |
| Support is extended for N-2 backward compatibility of software releases. | 21.24.1   |
| First introduced.                                                        | Pre 21.24 |

### Overview

CUPS supports backward compatibility of software releases on Control Plane (CP) and User Plane (UP). The feature allows seamless upgrade/downgrade of the software from/to one previous release (N-1)/two previous releases (N-2)/three previous releases (N-3)/four previous releases (N-4). The functionality includes support for the following:

- N-1/N-2/N-3 /N-4 compatibility of software releases on two CPs in ICSR mode—allows seamless upgrade of CPs from one version to another in CP 1:1 redundancy scenario.
- N-1/N-2/N-3 /N-4 compatibility of software releases on two UPs in ICSR mode—allows seamless upgrade of UPs from one version to another in UP 1:1 redundancy scenario.
- N-1/N-2/N-3/N-4 compatibility of software releases between CP and UP—allows seamless upgrade of the associated CP or UP from one version to another.

- N-1/N-2/N-3/N-4 compatibility of software releases between CP and UP with multi-Sx—allows seamless upgrade of the associated CP or UP from one version to another in multi-Sx scenario.



**Important** Contact your Cisco Account representative for procedural assistance prior to upgrading or downgrading your software versions.

### Version Exchange between CP and UP

Version/release information is exchanged when CP and UP pairs. The release information exchange also occurs when the CP pairs with a Standby CP or UP pairs with a Standby UP (in 1:1 redundancy scenario) through the heart beat message exchanged between Active and Standby.

When incompatible releases are paired, an Alarm (SNMP Trap) is raised. For details, see *SNMP Trap* section.

To indicate the peer version during the exchange of release information, the following new IE is included in the association request and heartbeat request messages.

| Information Elements | P               | Condition / Comment                                         | IE Length | IE ID |   |   |   |   |   |  |
|----------------------|-----------------|-------------------------------------------------------------|-----------|-------|---|---|---|---|---|--|
| Peer Version         | O               | Used to specify the peer GR/PFCP version and StarOS version | 4 bytes   | 245   |   |   |   |   |   |  |
|                      |                 | Bits                                                        |           |       |   |   |   |   |   |  |
|                      | Octets          | 8                                                           | 7         | 6     | 5 | 4 | 3 | 2 | 1 |  |
|                      | 1 to 2          | Peer Version IE Type = 245 (decimal)                        |           |       |   |   |   |   |   |  |
|                      | 3 to 4          | Length = n bytes                                            |           |       |   |   |   |   |   |  |
|                      | 5 to 8          | Peer GR/PFCP Version                                        |           |       |   |   |   |   |   |  |
|                      | 9 to 12         | StarOS GR Version                                           |           |       |   |   |   |   |   |  |
|                      | 13 to 13        | StarOS Version String Length                                |           |       |   |   |   |   |   |  |
|                      | Variable Length | StarOS Version String Value                                 |           |       |   |   |   |   |   |  |

## SNMP Traps

The following SNMP traps are raised when pairing is done with an incompatible release.

| SNMP Trap                      | Description                                                                                                   |
|--------------------------------|---------------------------------------------------------------------------------------------------------------|
| SRPPeerUnsupportedVersion      | The Active/Standby CP/UP in higher version raises the SNMP trap when the peer is in a version lower than N-4. |
| SRPPeerUnsupportedVersionClear | The Active/Standby CP/UP in higher version raises the SNMP trap to clear the SRPPeerUnsupportedVersion.       |
| SxPeerUnsupportedVersion       | The CP/UP in higher version raises the SNMP trap when the peer is in a version lower than N-4.                |

| SNMP Trap                     | Description                                                                            |
|-------------------------------|----------------------------------------------------------------------------------------|
| SxPeerUnsupportedVersionClear | The CP/UP in higher version raises an SNMP trap to clear the SxPeerUnsupportedVersion. |

## Limitations

The following are the known limitations of the feature:

- When the peer version is determined to be lower than the supported N-4 version, the association/pairing is allowed. However, functional aspect of the same isn't guaranteed.



**Caution** Don't attempt to upgrade from incompatible versions. Contact your Cisco Account representative for the upgrade path and steps.

SNMP traps are raised by the node on the latest version with respect to the StarOS version. For details, see the *SNMP Trap* section of this chapter.

- From release 21.24.1, RCM is checkpoint agnostic to enable support for future UP releases. Currently RCM does not support N-4 compatibility and only supports N-1 compatibility.

## Upgrading or Downgrading of CP and UP

The following Maintenance Operating Procedure (MOP) outlines the steps necessary to Upgrade or Downgrade a Control Plane and User plane from previous release (N-1)/(N-2)/(N-3)/(N-4) to or from the latest N release.



**Important** Contact your Cisco Account representative for procedural assistance prior to upgrading or downgrading your software versions.

The following are the Upgrade options:

- **Only CP Upgrade:** When requirement is to upgrade only the CP, and the UP must remain intact.
- **Only UP Upgrade:** When requirement is to upgrade only the UP, and the CP must remain intact.
- **Both CP and UP Upgrade:** When requirement is to upgrade both CP and UP. In this case, upgrade the CP first and then the UP or the other way around.

## Health Checks

Perform the following health checks after every operation of upgrade, downgrade, or reload of chassis.

1. Check the Service Redundancy Protocol (SRP) information on the Active chassis to avoid issues during an SRP switchover and decide if proactive analysis must be done before the SRP switchover. Use the following CLI commands:
  - `srp validate-configuration srp validate-switchover`

- **show srp info**

The following is a sample output.

```
Peer Configuration Validation: Complete
Last Peer Configuration Error: None
Last Peer Configuration Event: Wed Mar 18 15:34:02 2019 (1602 seconds ago)
Last Validate Switchover Status: None
Connection State: Connected
```

Check the following parameters:

- **Peer Configuration Validation: Complete**—If it shows "In Progress", you must wait and then execute the **show srp info** again after 15 seconds (approximately).
- **Last Peer Configuration Error: None**—If you see "Peer Checksum Validation Failure", then it indicates that there are configuration differences between Active and Standby chassis that must be fixed.
- **Last Validate Switchover Status: None**—The output must show as "None". And, output should be *Remote Chassis - Ready for Switchover (XX seconds ago)* when the **srp validate-configuration** and **srp validate-switchover** CLI commands are triggered.
- **Connection State: Connected**—The output must show as "Connected".

2. Check subscriber count on both Active and Standby chassis.

After sessions are up, execute **show subscribers summary | grep Total** CLI command in the Active chassis. The following is a sample output.

```
show subscribers summary | grep Total
Total Subscribers: 100
```

On Standby chassis, execute **show srp checkpoint statistics | grep allocated** CLI command. The following is a sample output.

```
show srp checkpoint statistics | grep allocated
Current pre-allocated calls: 100
```

3. Check the status of the license by executing **show license information** CLI command. It should be in "Good (Redundant)" and not in "Expired" state.
4. Check the Session Recovery Status by executing the **show session recovery status verbose** CLI command. The following is a sample output.

```
Session Recovery Status:
Overall Status : Ready For Recovery
Last Status Update : 7 seconds ago

 ----sessmgr--- ----aaamgr---- demux
cpu state active standby active standby active status
1/0 Active 8 1 8 1 17 Good
```

5. Verify all the SessMgrs are in Standby-Connected state on Standby chassis by executing **show srp checkpoint statistics | grep Sessmgrs** CLI command. The following is a sample output.

```
Number of Sessmgrs: 1
Sessmgrs in Active-Connected state: 0
Sessmgrs in Standby-Connected state: 8
Sessmgrs in Pending-Active state: 0
```

- Verify the status of all the cards to see if they are in Active or Standby state. The following is a sample output.

```
show card table
```

| Slot  | Card Type           | Oper State | SPOF | Attach |
|-------|---------------------|------------|------|--------|
| 1: VC | 5-Port Virtual Card | Active     | -    |        |

- Execute **show task resources | grep -v good** CLI command and its output must only display the total number of SessMgrs and sessions.
- Execute the **show crash list** CLI command to check if there were any new crashes.
- Execute the **show service all** CLI command to verify that the state is displayed as "Started" and not "Initialized".

## Build Upgrade

### Backup Configuration

- Back up the current configuration—save current configuration, that will be used in case of downgrade, which probably has all the features and configuration present until now.
- Collect the **show support details** on both Active and Standby chassis before making any changes or Upgrade.
- Perform Health Checks.

### Upgrade Procedure

- Perform chassis Health Checks on both the nodes.
- On the secondary chassis (ICSR), which is in Standby state, change boot priority with N build.
- Reload to latest 21.xx.xx build.
- Do the new configuration change on Standby chassis (For example, any new CLI, license, or configuration changes.).
- Do Health Check on the reloaded chassis. Check for any crashes or errors.

### Perform Switchover

- Before SRP switchover from Active to Standby on both chassis, check:
  - On Active chassis: **show subscriber summary | grep Total**
  - On Standby chassis: **show srp checkpoint statistics | grep allocated**



---

**Note** The count must be same for both.

---

- On Active and Standby chassis: **show sx peer**

For example:

```

||||| Sx Service
||||| ID
||||| |
Current Max Peer
vvvvv v Group Name Node ID Peer ID Timestamp v
Sessions Sessions State

CAAXD 22 CPGROUP21 209.165.200.225 50331649 2021-03-17:02:33:55 0
0 0 NONE

Total Peers: 1

```



---

**Note** Peer state must be Active and associated. Peer ID must match on both the chassis.

---

- d. On Standby chassis: **show srp checkpoint statistics | grep Sessmgrs**



---

**Note** "Number of Sessmgrs" must be equal to the "Sessmgrs in Standby- Connected state".

---

- e. On Active chassis:

1. **srp validate-configuration**: This CLI command is for initiating a configuration validation check from the ACTIVE chassis. If the validation doesn't have any error, output of this CLI command is blank.
2. **srp validate-switchover**: Validates both Active and Standby chassis are ready for a planned SRP switchover. If chassis is ready for switchover, then the output of this CLI command is blank.
3. **show srp info | grep "Last Validate Switchover Status"** : Output of this CLI command must be as follows.

```
Last Validate Switchover Status: Remote Chassis - Ready for Switchover
```

4. **show srp info debug**: Active and Standby chassis must have the same output.

2. On Active chassis: **srp initiate-switchover**

- a. Perform chassis Health Checks on both the nodes. Also check Step 1a and Step 1c under the *Performing Switchover* section. There can be a difference of 5%.
- b. Perform call testing since new sessions are serviced on the new Active chassis.
- c. Upgrade the old Active as mentioned in Step 2 through Step 5 under the *Upgrade Procedure* section.

## CP Upgrade

This section describes the procedure for CP-only upgrade.

1. Perform Health Check procedure on both CP nodes as mentioned in the [Health Checks, on page 733](#) section.

2. Perform Upgrade on Standby CP as mentioned in the [Build Upgrade, on page 735](#) section.



---

**Note** If the context names on CP and UP are different, then execute **debug pgw pfd-mgmt** CLI command on the upgraded CP before making it Active.

---

3. Perform Health Check on both chassis, and then do CP switchover to the upgraded chassis.
4. Verify that the new chassis is taking the new sessions, there are no new crashes, or session drop due to error scenarios. Do Health Check on both the CP and UP.
5. Upgrade the new Standby CP as mentioned in the [Build Upgrade, on page 735](#) section.

## UP Upgrade

This section describes the procedure for UP-only upgrade.

1. Perform Health Check procedure on both the UP nodes as mentioned in the [Health Checks, on page 733](#) section.
2. Perform Upgrade on Standby UP as mentioned in the [Build Upgrade, on page 735](#) section.
3. Do "sx-peer configuration" on the upgraded Standby chassis.
4. Perform Health Check on both the UP nodes, and then do UP switchover.
5. Upgrade the new Standby UP as mentioned in the [Build Upgrade, on page 735](#) section.

## CP and UP Upgrade

This section describes the procedure for upgrading the CP first and then upgrading the UP, or the other way round.

### Upgrading CP First

1. Perform Health Check procedure on both CP and UP, as mentioned in the [Health Checks, on page 733](#) section.
2. Perform Upgrade on Standby CP as mentioned in the [Build Upgrade, on page 735](#) section.



---

**Note** If the context names on CP and UP are different, then execute **debug pgw pfd-mgmt** CLI command on the upgraded CP before making it Active.

---

3. Perform Upgrade on Standby UP as mentioned in the [Build Upgrade, on page 735](#) section.
4. Upgrade both Standby CP and UP to N build.
5. Perform Health Check on both chassis, and then do CP switchover to the upgraded chassis.
6. Verify that the new chassis is taking the new sessions, there are no new crashes, or session drop due to error scenarios.

7. Perform Health Check on both the UP nodes, and then do UP switchover.
8. Perform Health Check on newly Active UP. Verify that there are no call drops, and data is flowing through the new chassis.
9. Upgrade new Standby CP and UP as mentioned in the [Build Upgrade, on page 735](#) section.

### Upgrading UP First

1. Perform Health Check and build transfer procedure on both CP and UP.
2. Perform Upgrade on Standby UP as mentioned in the [Build Upgrade, on page 735](#) section.
3. Do "sx-peer configuration" on the upgraded Standby chassis.
4. Perform Health Check on both the UP nodes, and then do UP switchover.
5. Perform Upgrade on new Standby UP as mentioned in the [Build Upgrade, on page 735](#) section.
6. Perform Upgrade on Standby CP as mentioned in the [Build Upgrade, on page 735](#) section.
7. Perform Health Check on both the CP nodes, and then do CP switchover.



---

**Note** If the context names on CP and UP are different, then execute **debug pgw pfd-mgmt** CLI command on the CP.

---

8. Upgrade new Standby CP chassis. Perform Health Check.
9. Perform Health Check on both the Active and Standby UP.
10. If everything is working as expected, then do the configuration changes on the Standby CP first. Then do the similar changes on the Active CP and execute **push config-to-up all** CLI command. New changes are pushed to the new Active UP.

## Downgrade Procedure

### Downgrade – Both CP and UP

If there are new configurations and/or configuration changes needed on CP as part of Upgrade, then follow the steps to upgrade the UP first.

1. Do Health Check on both CP and UP.
2. Change boot priority to the N-1/N-2/N-3/N-4 build on the Standby UP. Reload Standby UP.
3. Do "sx-peer configuration" on downgraded Standby UP.
4. Do Health Check on both the UP nodes and then do UP switchover.
5. Perform Step 1 to Step 3 on new Standby UP.
6. Change boot priority to N-1/N-2/N-3/N-4 build on the Standby CP. Reload the Standby CP.





---

**Note** If the context names on CP and UP are different, then execute the **debug pgw pfd-mgmt..** CLI command on the CP.

---

7. Load the configuration that has been saved in Step 1 mentioned in *Backup Configuration* section in [Build Upgrade, on page 735](#).
8. Do Health Check on both CP nodes and then do the CP switchover.
9. Perform Step 6 and Step 7 to downgrade old Active.
10. On Active CP, execute **push config-to-up all** CLI command so that changes in the configuration are pushed to the UP.

#### **Downgrade – CP Only**

Perform Step 6 through Step 10 mentioned in the *Downgrade – Both CP and UP* section.

#### **Downgrade – UP Only**

Perform Step 1 through Step 5 mentioned in the *Downgrade – Both CP and UP* section.



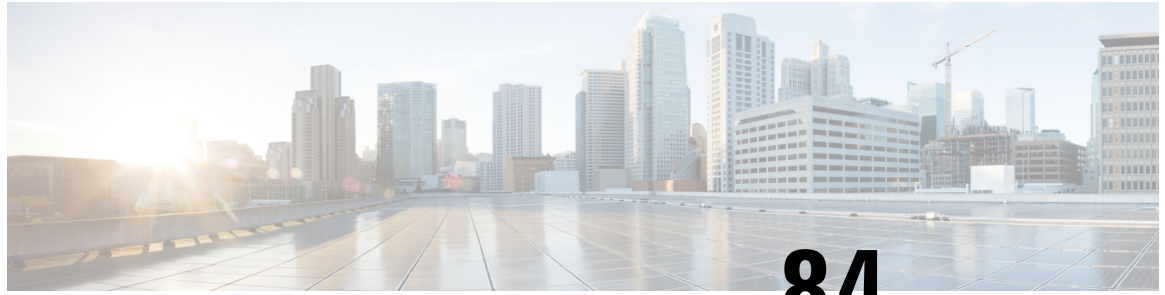

# CHAPTER 84

## Standard QCI Support

- [Revision History](#), on page 741
- [Feature Description](#), on page 741
- [Configure QCI](#), on page 742
- [Monitoring and Troubleshooting](#), on page 743

### Revision History



**Note** Revision history details are not provided for features introduced before release 21.24.

| Revision Details                                                                                                                                     | Release   |
|------------------------------------------------------------------------------------------------------------------------------------------------------|-----------|
| CUPS supports Standardized Mission Critical and Push-to-Talk (MC/PTT) QCI-67 application standard, which is used in mission critical communications. | 2024.03.0 |
| First introduced.                                                                                                                                    | Pre 21.24 |

### Feature Description



**Important** Standard QCI is not supported and qualified in the CUPS architecture.

The standardized QCI values—65, 66, 67, 69, and 70 support Mission Critical and Push-to-Talk (MC/PTT) applications. The standard QCIs are based on 3GPP TS 23.203 Release 12.

This feature supports the following functionality:

- Creates, deletes, and updates default and dedicated bearers.
- All applicable charging records include the standard QCI values.
- All features related to QCIs work with the standard QCI values.

- Creates, deletes, and updates Dynamic rules from PCRF with QCI 67.
- Creates and deletes Pre-defined rules with QCI 67
- Allows WiFi HO for bearer with QCI 67
- Supports S2B/S2A HO with MC QCIs
- Allows LTE to Wi-Fi Handover for Bearer with QCI
- Supports Bulkstats for APN and SAEGW
- MC-QCI values supports X-header insertion, DSCP marking, and EDR

## Limitations

The following are the known limitations of this feature:

- Does not support the overall eMPS functionality.
- If **require ecs credit-control session-mode per-subscriber** is configured, then URR is treated for entire subscriber session including secondary bearers which can lead to a problem in some applications. In CUPS, use the **credit-control-client override session-mode per-sub-session** command at the APN level to override the session mode configuration.

## Configure QCI

Use the **qci-qos-mapping** CLI command to configure the DSCP marking for QCI.

```

config
 qci-qos-mapping name
 qcinum { gbr } [{ downlink | uplink } [user-datagram dscp-marking
dscp-marking-value] [encaps-header { copy-inner | copy-outer | dscp-marking
dscp-marking-value }]]
 end

```

### NOTES:

- **qcinum**: Specify standard QoS Class Identifier between 1-9, 65,66,67,69,70,80,82,83 - integer 1..83.
- **gbr**: Specifies that this QCI type is Guaranteed Bit Rate (GBR).
- **downlink**: Configures parameters for downlink traffic.
- **uplink**: Configures parameters for uplink traffic.
- **encaps-header { copy-inner | copy-outer | dscp-marking *dscp-marking-value* }**: Specifies that the DSCP marking must be set on the encapsulation header for IP-in-IP, GRE, or GTP encapsulation.
  - **copy-inner** : Specifies that the DSCP marking is to be acquired from the UDP headers within the encapsulation.
  - **copy-outer** used to copy the DSCP value coming in the data packet from S1u interface to the data packet sent on the S5 interface and vice-versa.

- **dscp-marking** *dscp-marking-value* : Specifies that the DSCP marking is to be defined by this keyword.

*dscp-marking-value* is expressed as a hexadecimal number from 0x00 through 0x3F.

- **user-datagram dscp-marking** *dscp-marking-value*: Specifies that the IP DSCP marking is to be defined by this keyword.

*dscp-marking-value* is expressed as a hexadecimal number from 0x00 through 0x3F.

## Monitoring and Troubleshooting

This section provides information regarding monitoring and troubleshooting the feature.

### Show Command(s) and/or Outputs

This section provides information regarding show commands and/or their outputs in support of this feature.

#### show subscribers saegw-only imsi <imsi>

The output of this command includes QCI field under Bearer QoS and PCRF Authorized Bearer QoS as shown in the following example:

```
Bearer QoS :
 QCI : 67
 ARP : 0x054
 PCI : 1 (Disabled)
 PL : 5
 PVI : 0 (Enabled)
 MBR Uplink (bps) : 0
 GBR Uplink (bps) : 0
 MBR Downlink (bps) : 0
 GBR Downlink (bps) : 0

PCRF Authorized Bearer QoS:
 QCI: 67
 ARP: 0x054
 PCI: 1 (Disabled)
 PL : 5
 PVI: 0 (Enabled)
 MBR uplink (bps): n/a
 GBR uplink (bps): n/a
 Uplink APN AMBR (bps): 200000
 MBR downlink (bps): n/a
 GBR downlink (bps): n/a
 Downlink APN AMBR (bps): 300000
```

#### show apn statistics

The output of this command includes the following fields:

QCI 67:

- Bearer Active
- Bearer setup
- Bearer Released
- Bearer Rejected

**show active-charging sessions full all**

- Uplink Bytes forwarded
- Downlink Bytes forwarded
- Uplink pkts forwarded
- Downlink pkts forwarded
- Uplink Bytes dropped
- Downlink Bytes dropped
- Uplink pkts dropped
- Downlink pkts dropped
- Uplink Bytes dropped(MBR Excd)
- Downlink Bytes dropped(MBR Excd)
- Uplink pkts dropped(MBR Excd)
- Downlink pkts dropped(MBR Excd)

```

QCI 67:
 Bearer Active: 0 Bearer setup:
 Bearer Released: 0 Bearer Rejected:

 Uplink Bytes forwarded: 0 Downlink Bytes forwarded:
 Uplink pkts forwarded: 0 Downlink pkts forwarded:
 Uplink Bytes dropped: 0 Downlink Bytes dropped:
 Uplink pkts dropped: 0 Downlink pkts dropped:
 Uplink Bytes dropped(MBR Excd): 0 Downlink Bytes dropped(MBR Excd):
 Uplink pkts dropped(MBR Excd): 0 Downlink pkts dropped(MBR Excd):

```

**show active-charging sessions full all**

The output of this command includes the following fields:

```

Dynamic Charging Rule Definition(s) Configured:
Name Prior Content-Id Chrg-Type Rule Parameters

mcptt_audio_rule9 129 13009 Both Gate Status: Allow All
 QoS Class Identifier: 67
 ARP Priority Level: 2
 Reporting Level: Rating Grp
 Metering Method: Durn + Vol
 Uplink MBR: 49000
 Downlink MBR: 49000
 Uplink GBR: 49000
 Downlink GBR: 49000

```

## show qci-qos-mapping table name *name*

The output of this command displays QCI 67 is configured in the **qci-qos-mapping table**.

```
[local]qvpn-si# show qci-qos-mapping table
all name
[local]qvpn-si# show qci-qos-mapping table name qci-qos1
QCI-QOS Table Name: qci-qos1
Qci: 67
uplink: user-datagram dscp-marking 0x2e encaps-header dscp-marking 0x2e
downlink: user-datagram dscp-marking 0x2e encaps-header dscp-marking 0x2e
pre-rel8-qos-mapping: n/a qci type: gbr
```

## Bulk Statistics

Run the following CLI to check the counters available for APN and SAEGW schema.

### show bulkstats variables saegw | grep qci67

The following list of bulkstats variables are added in **saegw** schema.

- sgw-totepsbearact-qci67
- sgw-totepsbearset-qci67
- sgw-totepsbearrel-qci67
- sgw-totepsbearmod-qci67
- sgw-totepsbearrel-dedrsn-pgw-qci67
- sgw-totepsbearrel-dedrsn-slerr-qci67
- sgw-totepsbearrel-dedrsn-s5err-qci67
- sgw-totepsbearrel-dedrsn-s4err-qci67

#### Example:

```
[local]qvpn-si# show bulkstats variables saegw | grep qci67
189 saegw %sgw-totepsbearact-qci67% Int32 0 Gauge
204 saegw %sgw-totepsbearset-qci67% Int32 0 Counter
221 saegw %sgw-totepsbearrel-qci67% Int32 0 Counter
236 saegw %sgw-totepsbearmod-qci67% Int32 0 Counter
252 saegw %sgw-totepsbearrel-dedrsn-pgw-qci67% Int32 0 Counter
269 saegw %sgw-totepsbearrel-dedrsn-slerr-qci67% Int32 0 Counter
285 saegw %sgw-totepsbearrel-dedrsn-s5err-qci67% Int32 0 Counter
301 saegw %sgw-totepsbearrel-dedrsn-s4err-qci67% Int32 0 Counter
```

Similarly, you can use the **show bulkstats variables apn | grep qci67** command to view list of bulkstats variables in **apn** schema.

```
show bulkstats variables saegw | grep qci67
```





## CHAPTER 85

# Static IP Assignment from RADIUS

---

- [Feature Description, on page 747](#)
- [How it Works, on page 747](#)

## Feature Description

In this feature, static IP address for a subscriber is assigned from RADIUS server during the initial authentication procedure. This feature leverages the static IP address (UE-requested) functionality available in CUPS.

## How it Works

After the RADIUS server assigns static IP address to the session, the User Plane selection of static session is fixed as per chunk allocation to User Plane from the User Plane group that is associated to an APN.

If same static IP address range is used across multiple APN, then it's recommended to use same User Plane group in those APN.

For more information on static IP pool management, refer the IP Pool Management chapter in the *Ultra Packet Core CUPS User Plane Administration Guide* or *Ultra Packet Core CUPS Control Plane Administration Guide*.

## Limitations

The following are the known limitations of the feature:

- Static IP Address Pool assignment from RADIUS isn't supported as part of this feature.
- SAEGW-C doesn't support IPv4v6 PDN type call with static address received from RADIUS, even if one of the IP addresses (either IPv4 or IPv6, or both) is static address.
- SAEGW-C doesn't support allow-static type pool configuration.
- Multi-PDN call with static IP address allocation isn't supported.





## CHAPTER 86

# Support for Duplicate New Call

- [Revision History](#), on page 749
- [Feature Description](#), on page 749

## Revision History



**Note** Revision history details are not provided for features introduced before release 21.24.

| Revision Details | Release   |
|------------------|-----------|
| First introduced | Pre 21.24 |

## Feature Description



**Important** The Support for Duplicate New Call (Duplicate Call Accept) is an existing feature that is supported in the non-CUPS architecture. With this release, the feature is qualified in the CUPS architecture.

The feature enables new call connections when the UE is not able to gracefully disconnect from the Enterprise PDN before attempting to reconnect through other access method. In other words, the Control Plane validates the allocated IP address with the IP address that is used by other subscriber in Control Plane, so that the P-GW Control Plane can release the stale session locally and from respective User Plane.

As part of this feature, the following CLI command is supported in CUPS:

```
newcall { duplicate-subscriber-requested-address |
duplicate-subscriber-requested-v6-address } { accept | reject }
```

## Limitations

The IPv4v6 static allocation does not work in the CUPS architecture and so, the same limitation applies to this feature as well.





## CHAPTER 87

# Suspend and Resume Notification for Pure-S Calls

- [Revision History, on page 751](#)
- [Feature Description, on page 751](#)
- [How It Works, on page 751](#)

## Revision History



**Note** Revision history details are not provided for features introduced before release 21.24.

| Revision Details | Release   |
|------------------|-----------|
| First introduced | Pre 21.24 |

## Feature Description

Suspend and Resume Notifications for Pure-S calls are now supported in the CUPS architecture. The User Plane (UP) and Control Plane (CP) communicate through the Sx Establishment/Modification request when a Suspend/Resume notification is received.

Ongoing streams are maintained on the UP. When a Suspend/Resume notification is received, the CP changes the FAR action on UP through the Sx Modification request message. In response, the UP sets the appropriate FAR action.

On receiving a Modify Bearer request after a suspend notification, if an eNodeB TEID exists in the MBReq, the mode is set to Forward in the FAR. If the eNodeB TEID does not exist, then the mode is set to BUFFER.

## How It Works

For a Suspend notification, downlink data is suspended by setting downlink FAR action to DROP. For a Resume notification, downlink data is buffered by setting downlink FAR action to BUFFER.

## Call Flows

### Suspend Notification

On receipt of a Suspend notification in Pure-S call, the SGW-C updates the Download FAR action by sending Sx Session Modification request to SGW-U with FAR action set as DROP.

The following call flow, at a high level, illustrates the Suspend notification for Pure-S calls

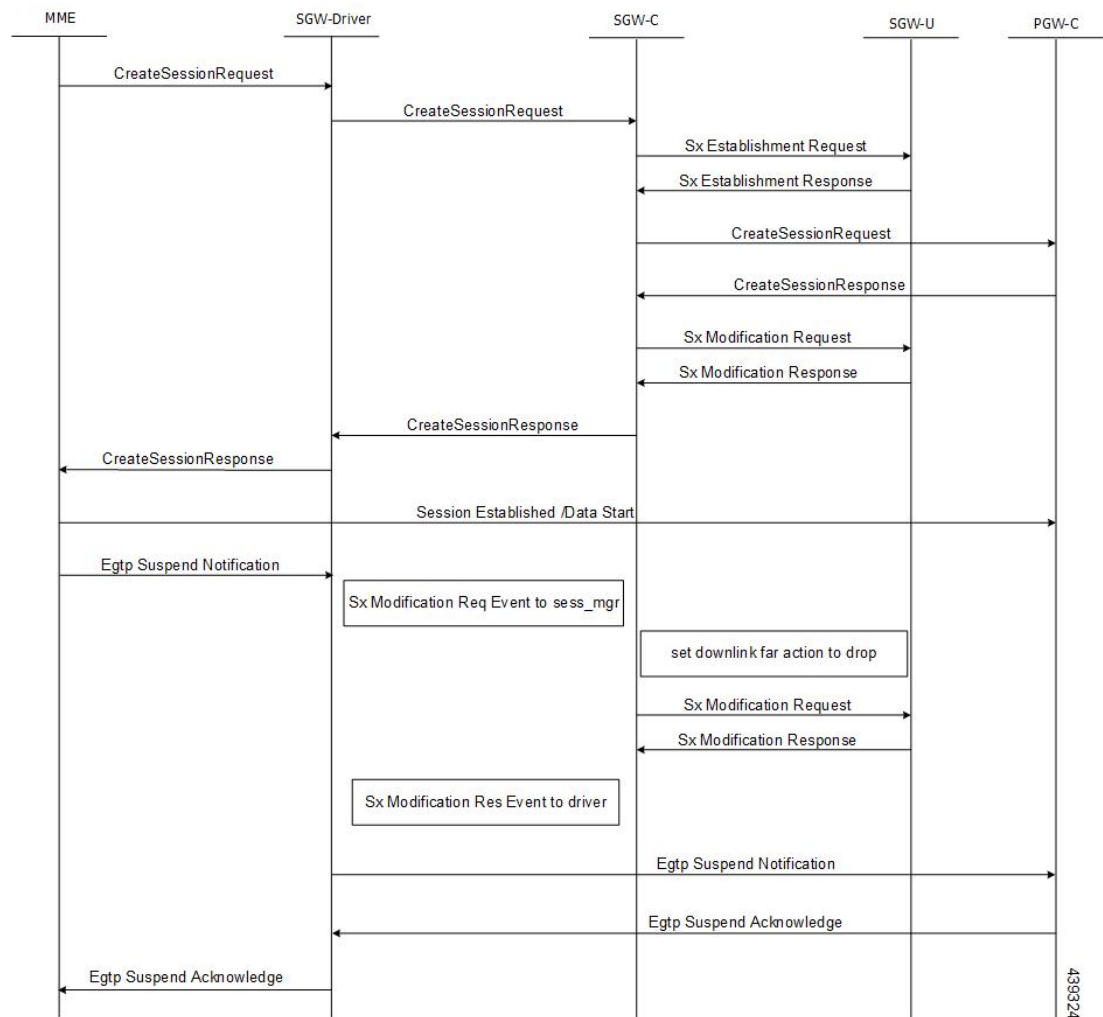

### Resume Notification

On receipt of Resume notification in Pure-S call, the SGW-C updates the Download FAR action by sending Sx Session Modification request to SGW-U with FAR action set as BUFFER.

The following call flow, at a high level, illustrates the Resume notification for Pure-S calls.

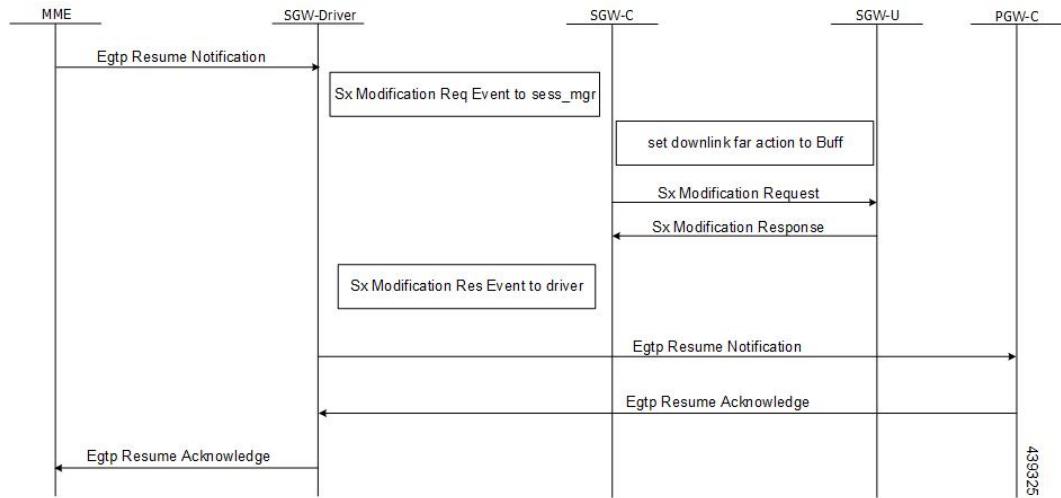







## CHAPTER 88

# TACACS+ Over IPsec

- [Revision History, on page 755](#)
- [Feature Description, on page 755](#)
- [How it Works, on page 757](#)
- [Configuring TACACS+ over IPsec, on page 760](#)
- [Monitoring and Troubleshooting, on page 763](#)

## Revision History

| Revision Details | Release |
|------------------|---------|
| First introduced | 21.24   |

## Feature Description

The Terminal Access Controller Access Control Server Plus (TACACS+) is a security protocol that is used for authenticating user access permissions on StarOS. To secure the authentication data that are sent over TACACS+ client and servers, CUPS VNFs support TACACS+ over IPsec for encrypting the authentication data.

## Architecture

The following diagram illustrates a secured TACACS+ architecture.

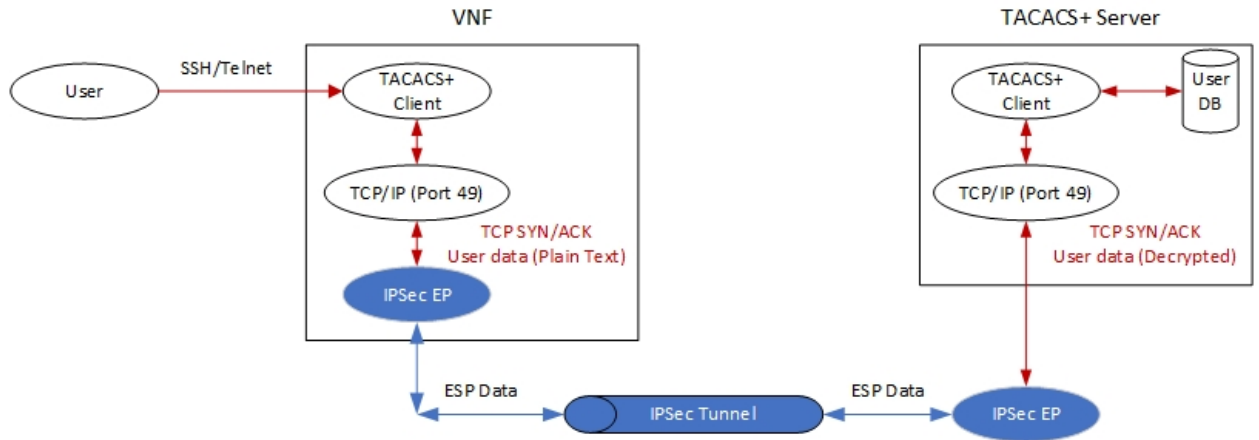

## Deployment Architecture

There are multiple ways you can use TACACS+ client/server in a secured way. You can either have single or multiple TACACS+ servers. A single VNF can host single or multiple clients. The TACACS+ over IPsec solution can handle multiple clients on a single VNF.

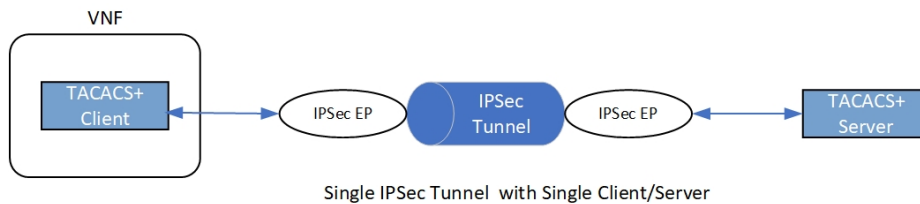
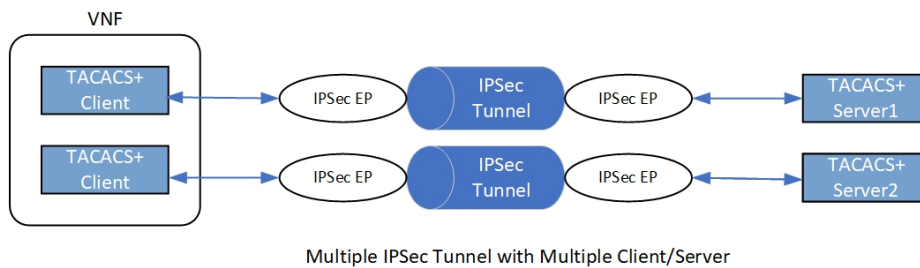
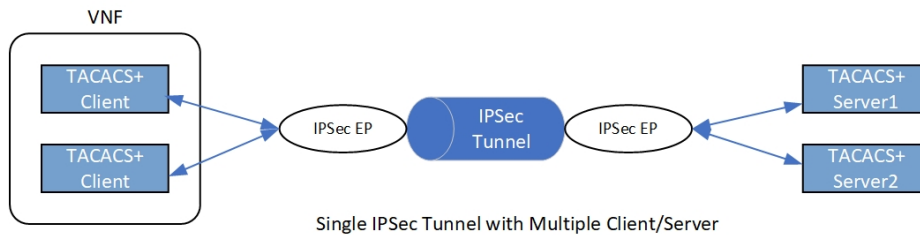

## How it Works

Depending on the deployment requirement, multiple applications that must be secured has independent ACL rules configured as part of a single crypto-map or separate crypto-map. In both the cases, multiple TUN interfaces are created which are attached to each application requiring encryption.

## Encryption of TACACS+ Client Data

The following diagram illustrates the tunnel establishment and packet encryption.

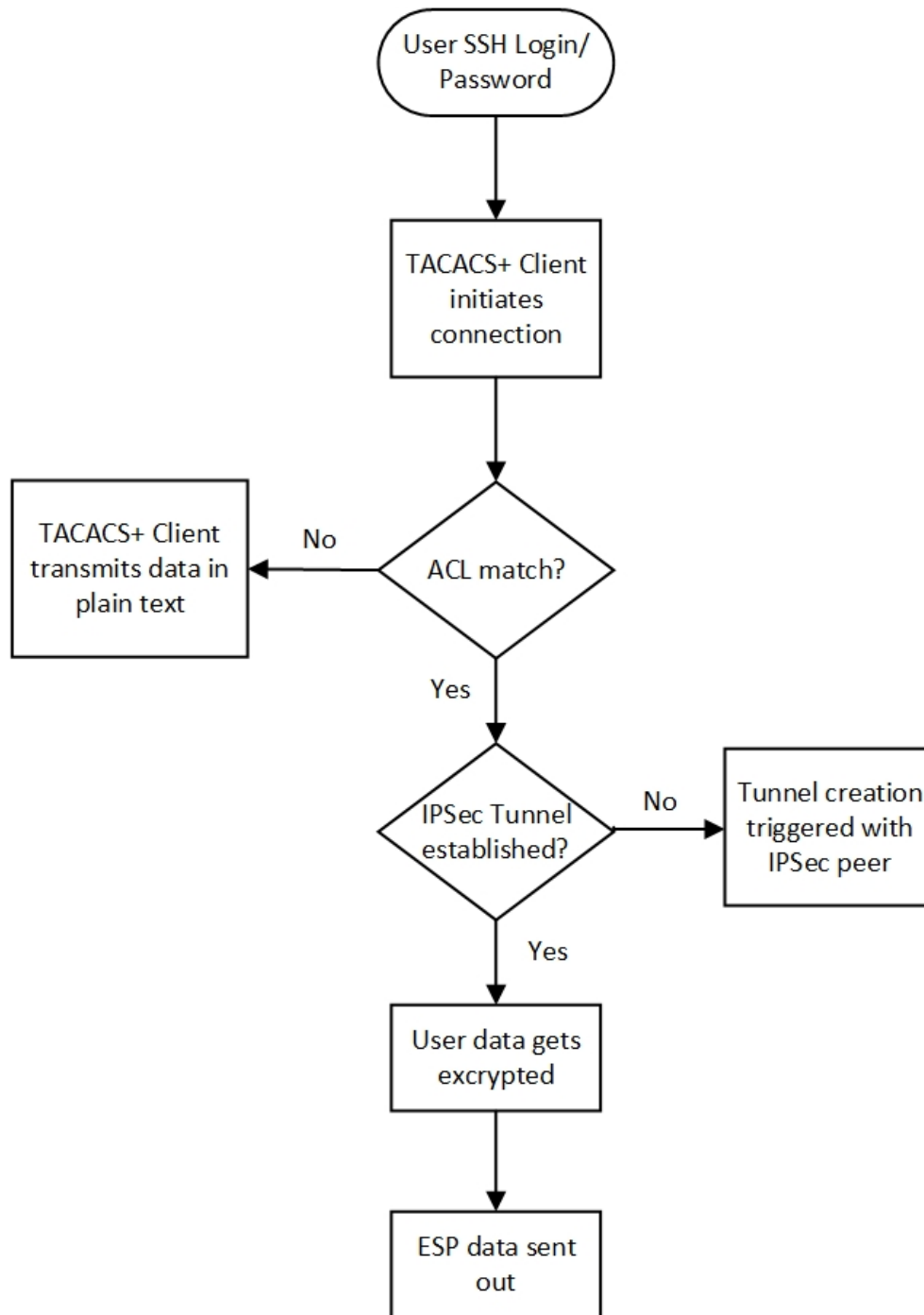

459086

## Decryption of TACACS+ Server Data

The following diagram illustrates the packet decryption.

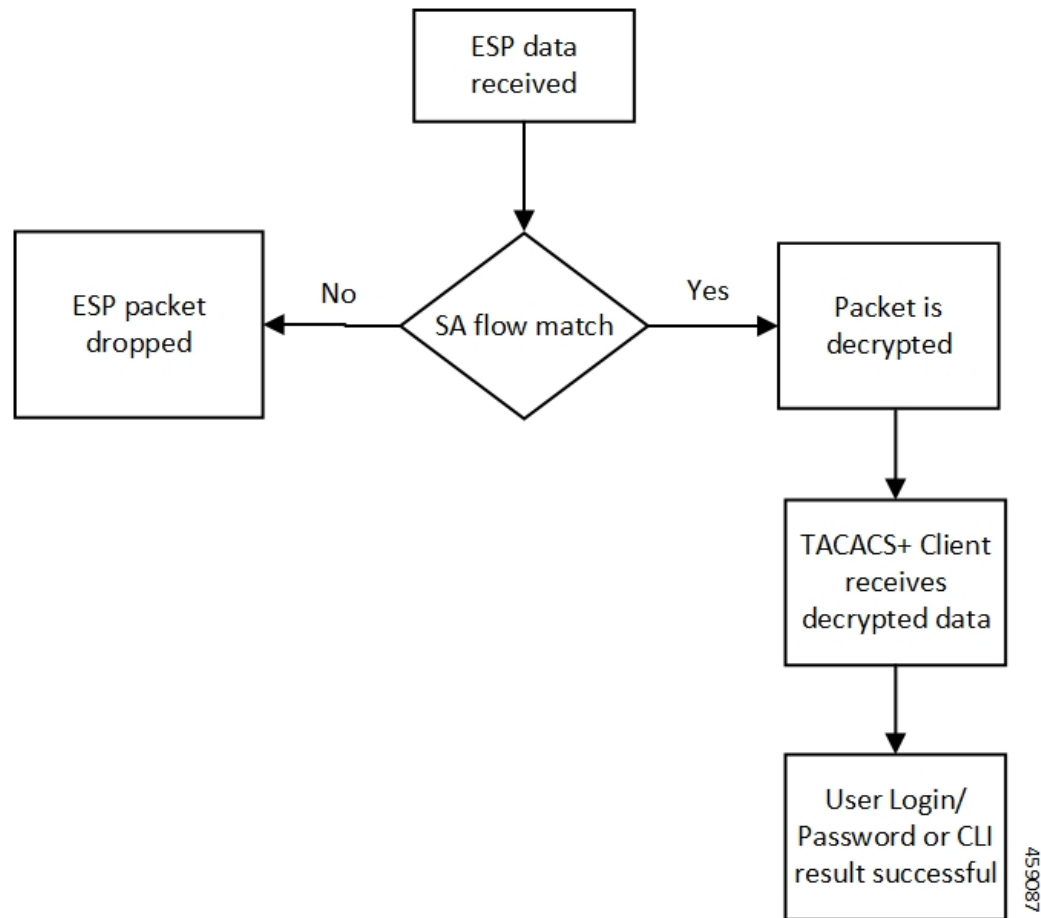

The following steps describe the packet flow to achieve TACACS+ data security through IPSec.

1. TACACS+/application initiates TCP connection with the TACACS+ server in the form of first TCP-SYN packet.
2. SYN packet is routed to TUN interface where it's directly read by the IpsecMgr in local context.
3. IpsecMgr sends the TCP-SYN packet to the first instance of NPUSIM for ACL match.
  - a. If ACL entry matches with the TCP-SYN packet, it sends the packet back to the IpsecMgr/local.
  - b. If the packet doesn't match the ACL entry, NPUSIM sends the packet to the local management interface bypassing the need to encrypt the packet.
4. IpsecMgr/local context receives the packet from NPUSIM after ACL match. It triggers the formation of IPSec tunnel with its peer by exchanging the IKE-INIT/IKE-AUTH packets using local raw socket created in local context.
5. The first TCP-SYN packet is dropped in the IpsecMgr/local after triggering the IPSec tunnel creation.
6. TACACS+/application sends another TCP-SYN packet and steps 2-3b are repeated.
7. When IpsecMgr receives the second TCP-SYN packet after ACL match from NPUSIM and the tunnel is already established, it encrypts the TCP-SYN packet and sends out through ESP raw socket created in the local context by the IpsecMgr/local.

8. IpsecMgr also listens for any ESP packets coming from ESP raw sockets in the local context via management ports.
9. On receiving any ESP packets, IpsecMgr/local sends ESP packet to NPUSIM for any SA flow processing.
10. If the SA flow matches in the NPUSIM, the ESP packet is sent to the IpsecMgr/local which does the decryption of the packet.
11. This packet could be TCP-SYN-ACK which could be the response of the second TCP-SYN packet sent from TACACS+ client to the TACACS+ server.
12. The decrypted packet is sent back to the same TUN interface from where it's sent back to the TACACS+/application.
13. The 2-way communication will be established, by the TACACS+/application which sends out the TCP-ACK packet. The above steps will be repeated to achieve the data security for all subsequent packets.

## Recovery

IPsec tunnels are established between TACACS+ client on Active and the TACACS+ server application. There's no IPsec tunnel established between Standby and TACACS+ server. In usual scenario, IPsec endpoints exchange informational (heartbeat) messages to check the health of the IPsec tunnels. If an Active VNF goes down, IPsec endpoint at the TACACS+ server detects dead peer detection (DPD) of the IPsec endpoint on the Active VNF where DPD timeout is also configurable. DPD triggers the clearance of the tunnels on the TACACS+ server side. Once the Standby VNF comes back as Active and TACACS+ application starts to exchange data with the TACACS+ server application, a new IPsec tunnel is established between new Active VNF and the TACACS+ server.

## Limitation

Following are the known limitations of the feature:

- TACACS+ using IPv6 is not supported with IPsec that uses IPv6 tunnel endpoints. However, without IPsec, TACACS+ using IPv6 is supported. Also, TACACS+ using IPv4 is supported with and without IPsec using IPv4 tunnel endpoints.
- The crypto maps in the local context must be pre-configured to be part of Day-0/Day-1 configuration. That is, crypto maps in local context, if any, must be configured before crypto maps are configured in any other context.

## Configuring TACACS+ over IPsec

This section describes how to configure the TACACS+ over IPsec feature.

Configuring the feature involves the following steps:

1. Configuring TACACS+ Configuration Mode.
2. Provisioning TACACS+ with IPsec.
3. Provisioning TACACS+ with IPsec in Tunnel Mode.

#### 4. Provisioning TACACS+ with IPsec in Transport Mode

## Configuring TACACS+ Configuration Mode

Configuration to provision TACACS+ on StarOS/VNF remains the same as was done in non-CUPS architecture. However, for tunnel establishment in “IPsec Tunnel Mode”, it’s mandatory to provision the **src-ip**. You must reserve one extra Source IP address (*src\_ip*) for TACACS+ communication and secure its communication.

For tunnel establishment in “IPsec Transport Mode”, there’s no requirement to provision an extra **src-ip**. The management interface IP address is picked as the **src-ip**.

The following is a sample configuration:

```
configure
 context context_name
 tacacs mode
 server priority priority_number ip-address server_ip_address password
 text_password src_ip
 accounting command
 authorization prompt
 #exit
 aaa tacacs+
end
```

## Provisioning TACACS+ with IPsec

The following configuration ensures that all IKE/ESP packets are handled in the user-space IpsecMgr/local and not by the IpsecMgr of non-local context and underlying data-plane like VPP, IFTask, or NPU.

```
configure
 require crypto ikev1-acl software context context
 require crypto ikev2-acl software context context
end
```

## Provisioning TACACS+ with IPsec in Tunnel Mode

The following example configuration creates crypto map in the local context in Tunnel mode wherein **209.165.201.1** and **209.165.200.225** is assumed as the TACACS+ server and client IP address respectively.



---

**Note** Currently, Tunnel mode is supported only in IKEv2.

---

```
configure
 context local
 ip access-list foo
 permit ip 209.165.200.225 1 0.0.0.0 209.165.201.1 0.0.0.0
 #exit
 ipsec transform-set B-foo
 group 14
 #exit
 ikev2-ikesa transform-set ikesa-foo
 group 14
```

```

#exit
crypto map foo ikev2-ipv4
 match address foo
 authentication local pre-shared-key encrypted key EncryptedKey1
 authentication remote pre-shared-key encrypted key EncryptedKey2
 ikev2-ikesa max-retransmission 3
 ikev2-ikesa retransmission-timeout 2000
 ikev2-ikesa transform-set list ikesa-foo
 ikev2-ikesa rekey
 payload foo-sa0 match ipv4
 ipsec transform-set list B-foo
 rekey keepalive
#exit
peer 209.165.200.226
ikev2-ikesa policy error-notification
#exit
interface local1
 ip address 209.165.200.227 255.255.255.224
 ipv6 address 2001:420:2c7f:f620::83/64 secondary
 crypto-map foo
#exit

```

## Provisioning TACACS+ with IPSec in Transport Mode

The following example configuration creates crypto map in the local context in Transport mode wherein **209.165.200.229** is assumed as the TACACS+ server IP address.



---

**Note** Currently, Transport mode is supported only in IKEv1.

---

```

configure
context local
 ip access-list foo
 permit tcp 209.165.200.228 0.0.0.0 209.165.200.229 0.0.0.0
 #exit
 ip routing shared-subnet
 ikev1 keepalive dpd interval 3600 timeout 10 num-retry 3
 crypto ipsec transform-set A-foo esp hmac sha1-96 cipher aes-cbc-128
 mode transport
 #exit
 ikev1 policy 1
 #exit
 crypto map foo ipsec-ikev1
 match address foo
 set peer 209.165.200.229
 set ikev1 encrypted preshared-key EncryptedKey1
 set pfs group2
 set transform-set A-foo
 #exit
 interface local1
 ip address 209.165.200.228 255.255.255.224
 ipv6 address 2001:420:2c7f:f620::84/64 secondary
 crypto-map foo
 #exit

```



# Monitoring and Troubleshooting

## Show Commands and Outputs

The following show CLI commands are available in support of this feature.

- **show crypto map**
- **show crypto ikev2-ikesa security-associations *summary***
- **show crypto ikev1 security-associations *summary***
- **show crypto statistics**
- **show crypto ipsec security-associations *summary***





## CHAPTER 89

# Tariff Time Support

- [Revision History](#), on page 765
- [Feature Description](#), on page 765

## Revision History



**Note** Revision history details are not provided for features introduced before release 21.24.

| Revision Details | Release   |
|------------------|-----------|
| First introduced | Pre 21.24 |

## Feature Description

The Tarrif switch time functionality is applied when a subscriber switches form one tarrif plan to another.

The Tariff-Time-Change AVP is used to determine the tariff switch time, and the Monitoring-Time IE is used to support the Tarrif Time support functionality.

After a tariff timer expiry, the Gateway accumulates the usage separately in a charging bucket and continues to consume from the original quota value. At the time of next reporting, (Quota exhausted or another control events) the Gateway will report both usages (before and after tarrif time change) for the same Charging Bucket.

The first reporting of this charging-bucket will have the Reporting-Reason: Tariff-Time-Change, and the second bucket will contain the last reporting reason, and the quota usage after the tariff-timer expiry.

The data traffic usage can be split into resource usage before a tariff switch and resources used after a tariff switch. The Tariff-Change-Usage AVP is used within the Used-Service-Units AVP to distinguish reported usage before and after the tariff time change.

### Limitations

Following are the known limitations of this feature:

- Only one tariff time per RG/Service ID combination is supported.

- Allocation of different quota before and after tariff time change is not supported. This functionality is not in compliance with the 3GPP standards.



## CHAPTER 90

# TEID Collision Handling during MOCN

- [Revision History, on page 767](#)
- [Feature Description, on page 767](#)
- [How it Works, on page 767](#)
- [Configuring TEID Collision with ULI Change, on page 770](#)
- [Monitoring and Troubleshooting, on page 771](#)

## Revision History

| Revision Details  | Release  |
|-------------------|----------|
| First introduced. | 21.28.m7 |

## Feature Description

Tunnel Endpoint Identifier (TEID) collisions support Multiple Operator Core Network (MOCN) scenario on CUPS. During TEID collision, P-GW or GGSN allocates a TEID to a home subscriber. In case of a stale session, in an S-GW or SGSN, the same TEID that is allocated by P-GW or GGSN, is allocated to a roaming subscriber.

To eliminate this scenario, CUPS supports TEID Collision with User Location Information (ULI) change to reject a request by configuring P-GW and GGSN when TEID collision occurs. This feature allows comparison only with Mobile Country Code (MCC) instead of comparison with MCC and Mobile Network Code (MNC). This feature supports the MOCN scenario on P-GW, SAEGW, and GGSN.

## How it Works

The S-GW sends BRCmd, DBCmd, and MBR messages to P-GW. SGSN sends the Update PDP Context message to P-GW. Due to the same TEID allocation to both the home subscriber and the roaming subscriber, and P-GW having no information on duplicate TEID allocation, P-GW accepts the request. The duplicate use of same TEID leads to the billing for the home subscriber for the data that is used by the roaming subscriber.

For 4G calls, you can configure the TEID Collision with ULI Change in P-GW. For 3G calls, you can configure this feature in GGSN. This feature works in the following way for P-GW and GGSN:

- For a home user equipment (UE) in P-GW, a request is rejected if the mobile country code and mobile network code (mcc\_mnc) information in ULI differs from the ULI information available in the session for the UE on P-GW. The request is for one of the following messages:
  - Bearer Resource Command
  - Modify Bearer Request
  - Delete Bearer Command
- For a home UE in GGSN, a request is rejected if the mobile country code and mobile network code information in ULI differs from the ULI information available in the session for the UE on GGSN. The request is for the following message:
  - Update PDP context

## Call Flows

This section describes the key call flows for P-GW and GGSN.

### TEID Collision with ULI Change on GGSN

The following call flow shows the handling of TEID Collision with ULI Change on GGSN:

**Figure 45: GTPC-Based TEID Collision Detection as per ULI Change**

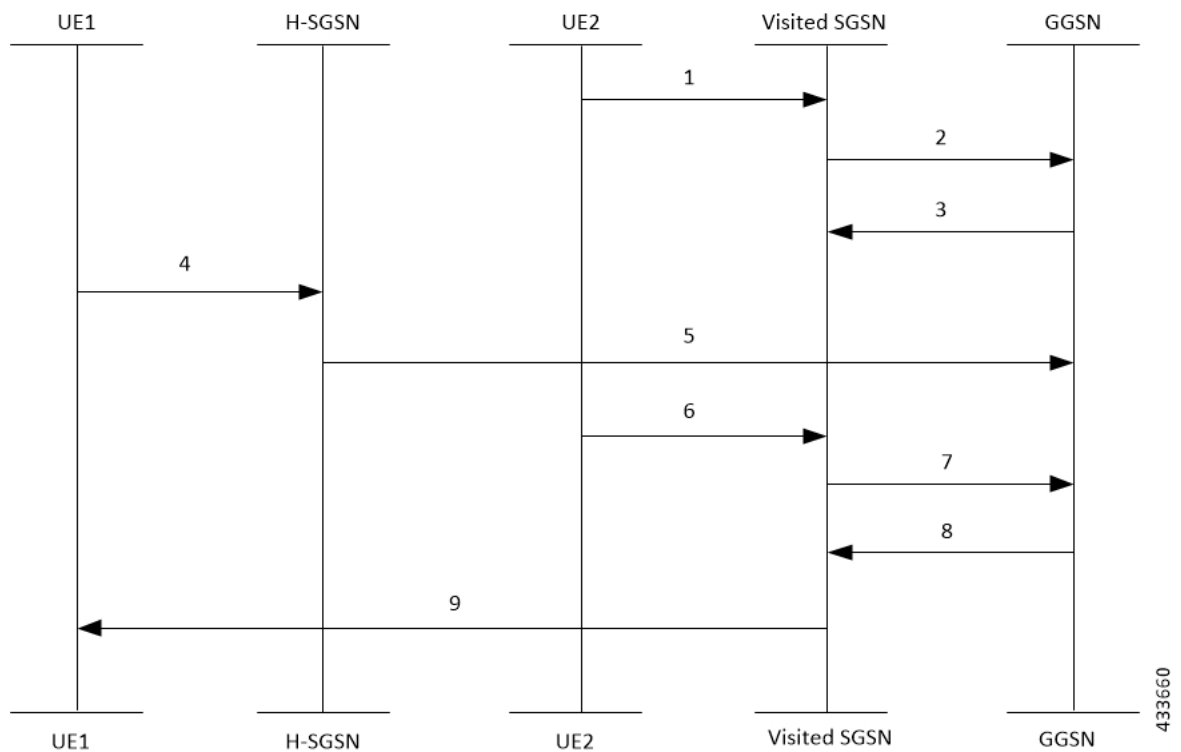

The call flow steps are listed below:

1. When a call is received from roaming subscriber, UE2 attempts to connect to GGSN through visited SGSN.
2. Roaming UE is allocated a TEID-x by the GGSN.
3. After the UE2 disconnects from the network, the session closes on GGSN. However, this session still continues on the visited SGSN.
4. The home UE Attach happens on GGSN through home SGSN.
5. GGSN allocates the same TEID-x that was earlier assigned on GGSN.
6. Roaming UE returns to the GGSN. As the session on visited SGSN still exists, same TEID-x is used from visited SGSN.
7. If the TEID Collision with ULI Change feature is enabled at GGSN and the UE1 is in the home PLMN (as in Step 4), all the control requests (GTPv1-C) are processed at GGSN to check for a TEID-based collision as per the ULI change.
8. GGSN checks for MCC only of the ULI against the PLMN-List of the GGSN-Service. If there is no match, GGSN rejects the request. For example, for a home UE in GGSN, if the MCC in ULI information differs from PLMN list of the message, the request will be rejected.
9. If there is a match, the request is sent for further processing.

## TEID Collision with ULI Change for P-GW

The following call flow shows the handling of TEID Collision with ULI Change on P-GW:

**Figure 46: EGTPC-Based TEID Collision Detection as per ULI Change**

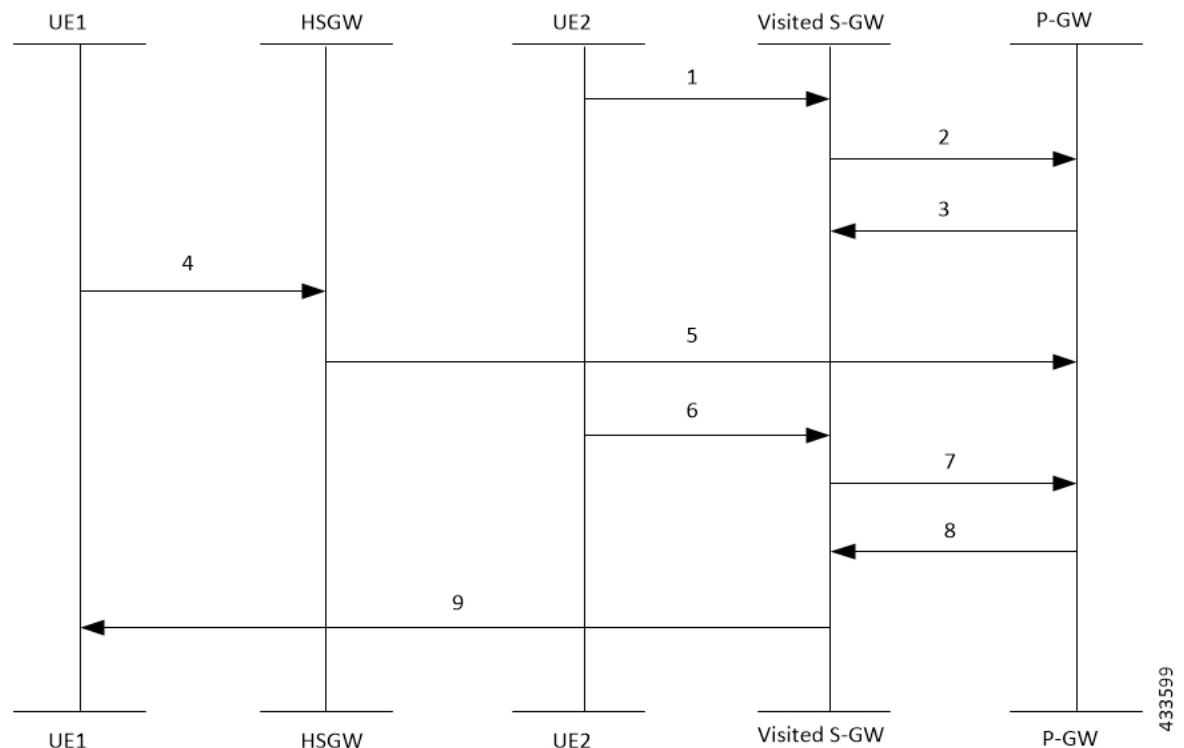

The call flow steps are listed below:

1. When a call is received from roaming subscriber, UE2 attempts to connect to P-GW through visited S-GW.
2. Roaming UE is allocated a TEID-x by the P-GW.
3. After the UE2 disconnects from the network, the session closes on P-GW. However, this session still continues on the visited S-GW.
4. The home UE Attach happens on P-GW through home S-GW.
5. P-GW allocates the same TEID-x that was earlier assigned on P-GW.
6. Roaming UE returns to the P-GW. As the session on visited S-GW still exists, same TEID-x is used from visited S-GW.
7. If the TEID Collision with ULI Change feature is enabled at P-GW and the UE1 is in the home PLMN (as in Step 4), all the control requests (GTPv2-C) are processed at P-GW to check for a TEID-based collision as per the ULI change.
8. P-GW checks only MCC of the ULI against the PLMN-LIST of the PGW-Service. If there is no match, P-GW rejects the request.
9. If there is a match, the request is sent for further processing.

## Configuring TEID Collision with ULI Change

This section provides information on the configuration of CLI command to reject a request in a TEID collision scenario on P-GW and GGSN.

### Configuring TEID Collision with ULI Change on GGSN

Use the following configuration to configure GGSN to reject a request when TEID collision occurs.

```
configure
 context context_name
 ggsn-service service_name
 [default | no] gtpc update-pdp-resp reject uli-mismatch mcc-only
 end
```

#### NOTES:

- **default**: Resets the command to its default setting—Disabled.
- **no**: Disables the GTPC parameters.
- **update-pdp-resp reject**: Updates the PDP Response Reject options.
- **uli-mismatch**: Rejects the Update PDP Request message if ULI is not part of the home PLMN session.
- **mcc-only**: Sends Update PDP Response with NON\_EXISTENT (CC 192) cause code if MCC that is received in Update PDP Request does not match to the home PLMN.



## Configuring TEID Collision with ULI Change on P-GW

Use the following configuration to configure P-GW to reject a request when TEID collision occurs.

```
configure
 context context_name
 pgw-service service_name
 [default | no] egtp bearer-req reject uli-mismatch mcc-only
 end
```

### NOTES:

- **default**: Resets the command to its default setting—Disabled.
- **no**: Disables the GTPC parameters.
- **bearer-req**: Performs configuration related to handling a Bearer Request.
- **reject**: Shows the Bearer Request Reject options.
- **uli-mismatch**: Sends Bearer Response with CONTEXT\_NOT\_FOUND (CC 64) cause code if the ULI that is received in Bearer Request does not match the ULI of the existing session.
- **mcc-only**: Sends Bearer Response with CONTEXT\_NOT\_FOUND (CC 64) cause code if the ULI with MCC that is received in Bearer Request does not match the MCC of the existing session.

## Monitoring and Troubleshooting

### Show Commands and Outputs

This section provides information about show commands and the fields that are introduced in support of TEID Collision with ULI Change.

#### show egtpc statistics

The output of this command displays the following fields for TEID Collision with ULI Change:

- Modify Bearer Request
  - Total TX
  - Initial TX
  - Retrans TX
  - Total RX
  - Initial RX
  - Retrans RX
  - Discarded
  - No Rsp RX

- Modify Bearer Response
  - Total TX
  - Initial TX
  - Accepted
  - Denied
  - Retrans TX
  - Total RX
  - Initial RX
  - Accepted
  - Denied
  - Discarded
- Bearer Resource Command
  - Total TX
  - Initial TX
  - Retrans TX
  - Total RX
  - Initial RX
  - Retrans RX
  - Discarded
  - No Rsp RX
- Bearer Resource Failure Indication
  - Total TX
  - Initial TX
  - Retrans TX
  - Total RX
  - Initial RX
  - Discarded
- Delete Bearer Command
  - Total TX
  - Initial TX
  - Retrans TX

- Total RX
- Initial RX
- Discarded
- Modify Bearer Request Without MME S11u TEID:
  - Local teid Mismatch:
    - Remote teid Mismatch
    - GnGp Call MBReq rejected FTEID absent
    - Tun Remote TEID Updated
    - Teid Collision with uli mismatch for BRcmd
    - Teid Collision with uli mismatch for DBCmd

## show gtpc statistics

The output of this command displays the following fields for TEID Collision with ULI Change:

- Update PDP Context RX
- Update PDP Context TX

## show ggsn-service name ggsn-service | more

The output of this command displays the following fields for TEID Collision ULI Change:

```
GTPC Update PDP Response with Non Existent cause if IMSI mismatch : Enabled
GTPC Update PDP Response with Non Existent cause if ULI mismatch : Enabled
GTPC Update PDP Response with Non Existent cause if MCC mismatch : Enabled
```

## show pgw-service name

The output of this command displays the following fields for TEID Collision ULI Change with only MCC mismatch:

```
EGTP Bearer Request with Context Not Found cause if MCC mismatch : Enabled
EGTP Bearer Request with Context Not Found cause if MCC mismatch : Disabled
```

show pgw-service name



# CHAPTER 91

## URL Blockedlisting

- [Revision History, on page 775](#)
- [Feature Description, on page 775](#)
- [How it Works, on page 775](#)
- [Configuring URL Blockedlisting, on page 777](#)
- [Monitoring and Troubleshooting, on page 778](#)

### Revision History



**Note** Revision history details are not provided for features introduced before release 21.24.

| Revision Details | Release   |
|------------------|-----------|
| First introduced | Pre 21.24 |

### Feature Description

The URL blockedlisting feature regulates the subscribers access to view or download content from websites whose URL or URI has been blockedlisted. It uses a database that records a list of URLs that indicates if the detected URL is categorized to be blocked or not.

### How it Works

To enable the URL blockedlisting feature on User Plane (UP), URL blockedlisting database should be present with a name “optblk.bin” under flash, or SFTP or under its sub-directory. This database directory path needs to be configured on user-plane, after user-plane services are brought up.

HTTP Analyzer must be enabled for URL blockedlisting. The HTTP analyzer extracts URL information from the incoming HTTP request data packet. Extracted URL content is compared with the URL Blockedlisting database. Once the incoming HTTP data packet’s URL matches with the database URL entry, that URL is treated as blockedlisted URL and one of the following actions takes place on that HTTP packet.

- Termination of flow
- Packet is discarded

The URL blockedlisting configurations must be configured on Control Plane (CP), Rulebase configuration under Active Charging Service. Additionally, two URL blockedlisting methods – Exact and Generic, are supported at Active Charging Service-level configuration, on CP. These CLI configurations are pushed to UP through PFD mechanism, during Sx association procedure, to the CP.



---

**Important** Blockedlisting database(s) are provided by – IWF (Internet Watch Foundation) and NCMEC (National Center for Missing and Exploited Children). The ASR5500, CUPS UP always receives the blockedlisting DB in Optimized Format (optimized blockedlisting DB format).

---

### URL Blockedlisting Database Upgrade

URL database upgrade is supported in 2 ways:

- Timer-based upgrade or Auto upgrade
- CLI-based upgrade or Manual upgrade

#### Timer-based or Auto-upgrade

After the database is loaded on the chassis for the first time, a timer, for a duration of 5 minutes, is started. This process is started to auto upgrade the database.

If at the expiry of the timer, a valid database with higher version is available at the directory path, then database upgrade procedure is initiated, and a newer version of the database is loaded on the UP chassis.

To upgrade a URL blockedlisting database, a higher version of valid URL Blockedlisting database with name “optblk\_f.bin” should be present at same directory as that of current database “optblk.bin”.

After the database is upgraded successfully, the earlier “optblk.bin” file gets renamed as “optblk\_0.bin” and “optblk\_f.bin” file gets renamed as “optblk.bin”. Here, “optblk\_0.bin” file is treated as a backup file of older database.

If one more upgrade is performed, then “optblk\_0.bin” file will be renamed as “optblk\_1.bin” file and current “optblk.bin” will get renamed as “optblk\_0.bin”, and so on.

The number of backup files to be stored in the database can be configured using the **max-versions** CLI on UP.

#### CLI-based or Manual Upgrade

In this upgrade method, the CLI command - **upgrade url-blacklisting database**, upgrades the current database to a newer version.

## Limitations

In this release, session recovery and user-plane redundancy support is not fully qualified.

# Configuring URL Blockedlisting

## Loading URL Blockedlisting Database on UP

Use the following configuration to load URL blockedlisting database on UP.

In releases prior to StarOS 21.26:

```
configure
 url-blacklisting database directory path database_directory_path
 url-blacklisting database max-versions max_version_value
end
```

From StarOS 21.26 and later releases:

```
configure
 url-blockedlisting database directory path database_directory_path
 url-blockedlisting database max-versions max_version_value
end
```

### NOTES:

- **database directory path:** Configures the database directory path.  
The *database\_directory\_path* is a string of size 1 to 255.
- **max-versions:** Configures the maximum database upgrade versions.  
The *max\_version\_value* is an integer from 0 to 3.

## Configuration to Enable URL Blockedlisting

Use the following configuration to enable URL blockedlisting feature on Control Plane.

In releases prior to CUPS 21.26:

```
configure
 require active-charging service_name
 url-blacklisting match-method [exact | generic]
 rulebase rulebase_name
 url-blacklisting action [discard | terminate-flow]
end
```

From CUPS 21.26 and later releases:

```
configure
 require active-charging service_name
 url-blockedlisting match-method [exact | generic]
 rulebase rulebase_name
 url-blockedlisting action [discard | terminate-flow]
end
```

### NOTES:

- **match-method [ exact | generic ]:** Specifies the match method used for URL blockedlisting.

**exact:** URL Blockedlisting perform an exact-match of URL.

**generic:** URL Blockedlisting perform generic-match of URL.

- **url-blockedlisting action [ discard | terminate-flow ]**

**discard:** Discards the HTTP packet received.

**terminate-flow:** Terminates the flow of the HTTP packet received.

## URL Blockedlisting Database Upgrade

Use the following command to upgrade the URL Blockedlisting Database.

In releases prior to CUPS 21.26:

```
upgrade url-blacklisting database
```

From CUPS 21.26 and later releases:

```
upgrade url-blockedlisting database
```



---

**Note** This CLI is used for manual upgrade of URL Blockedlisting database. File `optblk_f.bin` must be present in order to upgrade URL Blockedlisting database.

---

## Monitoring and Troubleshooting

This section provides information regarding the CLI command available in support of monitoring and troubleshooting the feature.

### Show Command(s) and/or Outputs

This section provides information regarding show commands and/or their outputs in support of this feature.

#### show user-plane-service url-blacklisting database

The following fields are displayed in support of this feature:

- URL Blacklisting Static Rating Databases:
  - Last Upgrade Status
  - Path
    - Database Status
    - Number of URLs in DB
    - Type
    - Version
    - Creation Time



- Hostname
- Comment
- Last Access Time
- Last Modification Time
- Last Status Change Time

### **show user-plane-service url-blacklisting database url *database\_directory\_path***

The following fields are displayed in support of this feature:

- URL Blacklisting Static Rating Databases:
  - Last Upgrade Status
  - Path
    - Database Status
    - Number of URLs in DB
    - Type
    - Version
    - Creation Time
    - Hostname
    - Comment
    - Last Access Time
    - Last Modification Time
    - Last Status Change Time

### **show user-plane-service url-blacklisting database facility sessmgr all**

The following fields are displayed in support of this feature:

- URL-Blacklisting SessMgr Instance Based Database Configuration
  - SessMgr Instance
  - BL DB Load Status
  - BL DB Version
  - Number of URLs
  - Checksum

## show user-plane-service inline-services info

The following fields are displayed in support of this feature:

- URL-Blacklisting: Enabled
  - URL-Blacklisting Match-method: Generic

## show user-plane-service rulebase name *rulebase\_name*

The following fields are displayed in support of this feature:

- URL-Blacklisting Action
- URL-Blacklisting Content ID

## show user-plane-service inline-services url-blockedlisting statistics

The following are displayed in support of this feature:

- Cumulative URL-Blockedlisting Statistics
  - Blockedlisting URL hits
  - Blockedlisting URL misses
  - Total rulebases matched

## show user-plane-service inline-services url-blacklisting statistics rulebase name *rulebase\_name*

The following fields are displayed in support of this feature:

- Rulebase Name
  - URL-Blacklisting Statistics
    - Blacklisted URL hits
    - Blacklisted URL misses
- Total rulebases matched

## Bulk Statistics

The following bulk statistics are added to the System schema in support of URL Blacklisting feature:

- **url-blacklisting-hits**: Indicated the total number of URLs blacklisted.
- **url-blacklisting-misses**: Indicated the total number blacklisted URLs missed.

## SNMP Traps

The following SNMP trap are added in support of this feature:

- **BLDBError**: Specifies the blacklisting OPTBLDB file error displayed with an error code.
- **BLDBErrorClear**: Specifies the blacklisting OPTBLDB file error removed.
- **BLDBUpgradeError**: Specifies the blacklisting OPTBLDB file error displayed with an error code.
- **BLDBUpgradeErrorClear**: Specifies the Blacklisting OPTBLDB file error removed.





## CHAPTER 92

# User Plane Selection

- [APN and APN Profile-Based User Plane Selection, on page 783](#)
- [Dynamic User Plane Selection, on page 788](#)
- [Multiple UP Group Support, on page 803](#)
- [Priority between UP Groups, on page 807](#)
- [User Plane Selection based on TAC Range, on page 817](#)

## APN and APN Profile-Based User Plane Selection

### Revision History



**Note** Revision history details are not provided for features introduced before release 21.24.

| Revision Details  | Release   |
|-------------------|-----------|
| First introduced. | Pre 21.24 |

### Feature Description

In the CUPS architecture, SAEGW-C selects a user plane by using an algorithm that selects the least connected user plane. It also selects the user plane from a flat list of user planes.

This feature enables the operator to select a user plane from a specific UP group associated with an APN or APN Profile.

In S-GW, UP groups are associated with an Access Point Name (APN) profile. An APN profile groups a set of APN-specific parameters that are applicable to one or more APNs. A single APN profile can be associated with multiple operator policies.

## How It Works

Cisco CUPS solution supports static UP selection. This is based on static selection of active and available SAEGW-U. The static UP selection uses the UP Group concept. UP group is a group of UP SAEGW-U. Each APN is then associated with one UP group. APN is served by the UP groups associated with it. UPs are selected using an algorithm that selects the least connected UP available in that particular group.

### UP Group

A UP can be part of only one UP group. In a UP Group, all UPs must be of the same capacity and capability. Different type of UPs must be part of different UP groups.

CUPS supports the following types of UP groups:

- **Specific UP Group**—It is a set of explicitly configured UPs. The specific group gives the flexibility to group certain specific types of UPs together. This helps in reserving specific set of UPs for a specific purpose. There can be multiple specific groups that can be configured.
- **Default UP Group**—This is a default group that groups all UPs that are registered and are not explicitly configured as part of any specific UP group. The default group has advantage of registering UPs in a zero touch manner without configuring a UP on the CP explicitly. This type of group is suited for collocated CUPS cases where all UPs with the same capacity and capability are in the same data center. The default group optimizes the UP configuration on CP.

An APN can be associated with UP group. If no group is associated with an APN, then default UP group is used to serve that APN. Similarly, for selecting UP for Pure-S calls, UP group can be associated to an APN profile. If there is no APN Profile/Operator-Policy defined or no group is associated with APN Profile, then SAEGW-C uses the "default" UP group for selection.

An operator can reserve certain UPs for certain applications. For example, IMS, Internet, and IOT can have different UP groups.

With this feature:

- SAEGW-C always has one user plane group with the name "default".
- SAEGW-C supports a maximum number of 100 user planes.
- The user planes can be organized in different groups.
- Currently, 100 user-plane-groups can be configured, and a single group can have a maximum number of 100 user planes.
- One user plane can be part of only one user plane group.
- Multiple user planes can be configured in specific user-plane-groups and default group.
- The user planes associated with SAEGW-C but not defined in any user plane group are added in the default group.
- An operator can associate a User Plane Group to APN and APN Profile.
- If there is no User Plane group associated to an APN for Pure-P and Collapsed calls, SAEGW-C uses the default group to select user plane for that session.
- If there is no user plane group associated to APN Profile or no APN Profile is defined, then SAEGW-C uses the "default" user plane group for Pure-S calls.

- For multi-PDN call with same APN, the same user plane is selected. For multi-PDN call with different APN, a different user plane from a different user plane group is selected.
- User Plane group associated with APN is also used while sending IP Pool chunks to User Plane. IP Pool associated with APN is broken down to chunks and are available for distribution to all UPs from group associated with APN.
- For user-plane-groups that are not associated with any APN, SAEGW-C does not send any IP pool chunks to UPs belonging to these groups. This is also applicable to the default group.
- Sessions with static IP address (IPv4 or IPv6) are supported. The user plane selection of static session is fixed as per chunk allocation to user plane from user plane group associated to an APN.
- If the same static IP address range is used across multiple APNs, it is recommended to use the same user plane group in those APNs.

## Architecture

The following figure depicts a high-level architecture of this feature.

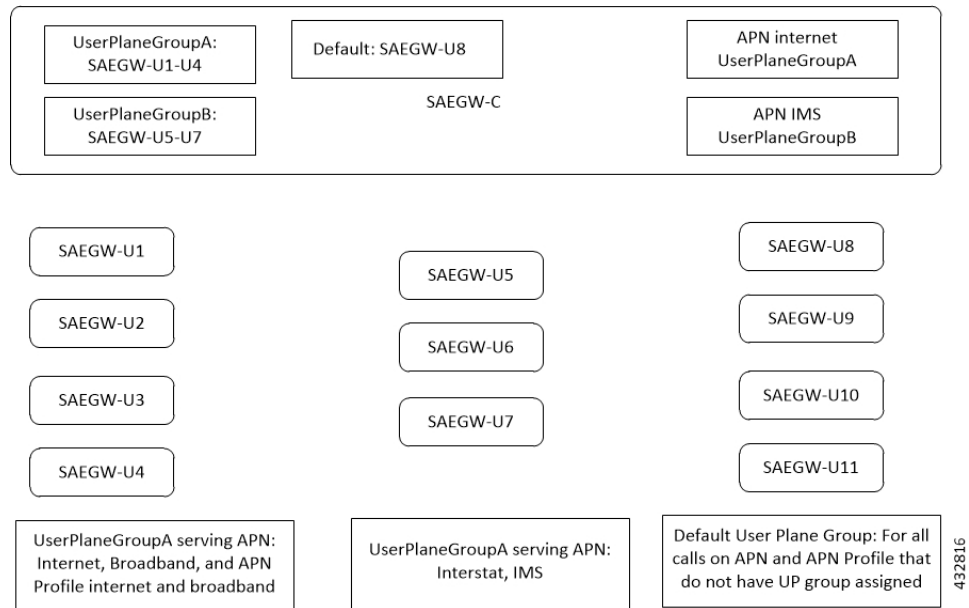

## Session Recovery and ICSR

Sx-Demux Recovery, ICSR and Sessmgr and VPNmgr recovery is supported

## Limitations

In CUPS architecture, this feature has the following known limitations:

- SAEGW-C does not support IPv4v6 PDN type call with static address received from UE, even if one of the IP address (either IPv4 or IPv6, or both) is static address.
- SAEGW-C does not support “allow-static” type pool configuration.
- Multi-PDN call with static IP address allocation is not supported.

## Licensing

This feature is license-controlled. Contact your Cisco Account representative for license related details.

## Configuring APN-Based UP Grouping

This section provides information about configurations available in support of this feature.

Prerequisites:

- Same IP context should be present at Control-Plane as well as in User-Plane.
- IP context name which is specified in APN configuration should be same at Control-Plane and User-Plane.

## Configuring User Plane Group in Control Plane

New user-plane-group is defined at the global configuration mode which lists User Plane endpoints

1. User Plane Group name “default” is created by default. Operator can add and remove peer-node-id in default group. Operator cannot delete user-plane-group “default”
2. If Sx Association Setup Request is received for any User plane node-id which is not part of any defined User Plane Group, it will be part of Default User Plane Group.

## Configuring User Plane Group

Use the following CLI commands to configure User Plane endpoint group in Control Plane.

```
configure
 [no] user-plane-group group_name
end
```

Notes:

- Removal of user-plane-group will trigger Sx-Association release from Control Plane of individual peer id from that group.

## Configuring Peer Node ID and User Plane Node IP Address

Use the following configuration commands to configure time-based PCC rule.

```
configure
 user-plane-group group_name
 [no] peer-node-id { ipv4-address | ipv6-address }
 end
```

Notes:

- Removal of peer-node-id will trigger Sx-Association Release from Control Plane for that peer id.

## Verifying the User Plane Group

Use the following CLI command for verification.

```
show user-plane-group { all | name group_name }
```



## Associating User Plane Group with APN

It is desired that calls to a particular APN be connected to a certain group of user-planes based on some predefined selection criteria. Operator can associate User Plane Group to APN Configuration.

User Plane group configured to APN is also used while sending IP Pool chunks to User Plane. If there is IP Pool associated with APN, only then the chunks from that pool will be sent to all User Planes in this group.

User Plane Group configuration in APN is used to select User Plane for P-GW Pure-P and Collapsed Call.

If there is no specific group is configured in APN then “default” group will be used.

## Configuring User Plane Group in APN

Use the following CLI commands to configure User Plane group in APN.

```
configure
context context_name
 apn apn_name
 [no] user-plane-group group_name
 end
```

NOTE: In this EFT release, removal or change of user-plane-group from APN is not supported.

## Verifying the User Plane Group in APN

Use the following CLI command for verification.

```
show apn name apn_name }
```

## Associating User Plane Group with APN Profile

To select User Plane for S-GW Pure-S calls, SAEGW-C uses user-plane-group associated with APN Profile under Operator Policy. When APN profile do not have any user-plane-group associated or no APN profile was used, then SAEGW-C will select User Plane from default user-plane-group.

## Configuring User Plane Group in APN Profile

Use the following CLI commands to configure User Plane group in APN.

```
configure
apn-profile profile_name
 [no] user-plane-group group_name
end
```

## Method of Procedure (MOP) to Remove or Change User Plane Group from APN

When explicit user-plane-group is configured, or implicit default group is used, the SAEGW-C sends IP Pool chunks from the pool that is configured (or global pool when there is no explicit pool configuration in APN) to the user planes in the group.

If you want to change or remove user-plane-group associated to a APN, then it is recommended to follow this MOP because, currently, there is no support of run time config change of user-plane-group in APN after User Plane is associated with SAEGW-C.

Before changing user-plane-group in APN it is recommended to use the following CLI command to first gracefully clear all existing calls belonging to user-plane-group associated with APN.

```
clear subscribers saegw-only user-plane-group group_name no-select-up
```

Executing this CLI command releases all sessions from User Plane belonging to the mentioned user-plane-group gracefully, and marks that User Plane as "Not Available for Session Selection". This User Plane continues to be in Associated state, but it will not be available for Session selection.



**Note** When the **clear subscribers** command is executed on UP, CP will not be informed and CP will consider the sessions as running.

After clearing the session, execute either of the following CLI command on User Plane to remove its association from Control Plane, and make required changes after UP association is released.

```
no user-plane-service service_name
```

Or:

```
no peer-node-id { ipv4-address ipv4_address | ipv6-address ipv6_address }
```

## Monitoring and Troubleshooting APN-Based UP Grouping

This feature supports the following CLI commands:

- **show sx peers**
  - Group Name Column in the output of this command displays the name of the user-plane-group under which the peer is configured at Control Plane.
  - Peer, which is not part of any group, will be added under "default" user-plane-group
  - For a user-plane-group that is not associated with any "apn", SAEGW-C will not send any IP pools to user planes from this group. Hence, in the output of this command, for the Group Name that is not associated with "apn", the IP Pool status will be "N – Not Applicable". Also, for user planes in this group, when **show sx peers** is executed on UP, it displays Peer ID as "0".
- **show ip user-plane**
- **show ip pool-chunks up-id up\_id user-plane-group name up\_group\_name**

## Dynamic User Plane Selection

### Revision History



**Note** Revision history details are not provided for features introduced before release 21.24.

| Revision Details  | Release   |
|-------------------|-----------|
| First introduced. | Pre 21.24 |

## Feature Description

In a Multi-access Edge Computing (MEC) architecture, selecting an edge User Plane (UP) provides low latency and maximum bandwidth efficiency. The location information of the user equipment (UE) is used to select an UP.

For selecting an edge UP, the following levels of granularity are considered:

- E-UTRAN Cell Global Identifier (ECGI) or Cell Global Identification (CGI) offers the lowest level of granularity.
- Tracking Area Identifier (TAI) or Routing Area Identity (RAI) or Service Area Identifier (SAI) offers the next level of granularity.
- TAI-SAI-RAI-ECGI offers fixed priority of TAI, SAI, RAI and ECGI in which the ULI type is matched when more than one ULI type is received.

## Architecture

To select a UP based on the location parameter of the upcoming session, a DNS Name Authority Pointer (NAPTR) query including TAI/RAI/SAI or ECGI/CGI is sent to the DNS server. The DNS (NAPTR) response contains a list of UP IPs. To select an UP from this list, a Load Control Information (LCI) and session count is applied to shortlist.

This feature enables virtual APN selection along with dynamic UP selection. As a result, APN is selected based on the specified criteria. The selection criteria for the virtual APN is also based on location, for example, the Radio Admission Control (RAC) range.

Dynamic UP selection is based on the **configure fqdn postfix** CLI command and the type of selected APN. If the type is ECGI or CGI, then a DNS Straightforward NAPTR (S-NAPTR) query is sent based on the cell ID. If the type is configured as tracking or routing area, then TAI or RAI or SAI is used for DNS (S-NAPTR) query.

To get the list of associated Sx peers, UP group from the selected APN is used. The UP IPs in DNS (S-NAPTR) response is matched with the list of Sx peers in the group. The peer that is either least loaded or have the least sessions is selected from this list.

If ULI contains unsupported location data, dynamic UP selection is based on the RAI IE that comes outside ULI.

## How it Works

This section describes the sequence of operation.

1. For P-GW, GGSN, or SAEGW, Fully Qualified Domain Names (FQDN) in UP, which contains **fqdn-postfix** and FQDN type (ECGI/CGI or TAI/RAI/SAI) are configured at APN level.
2. During an S6b interface protocol-based authorization, the **fqdn-postfix** value in the authorization response is used (applicable for P-GW, GGSN, or SAEGW service only).
3. The DNS (S-NAPTR) query is sent to the DNS server.



---

**Note** DNS (S-NAPTR) is generated based on the type (E-CGI | RAI-TAI-SAI | TAI-SAI-RAI-ECGI) configured in user plane FQDN at APN level for GGSN.

---

4. The response that is received from the DNS server is matched for service **x-3gpp-upf:x-sxb** for P-GW/GGSN/SAEGW (Collapsed) and **x-3gpp-upf:x-sxa** for S-GW.
5. The matching DNS (S-NAPTR) response is processed recursively for UP IPs.
  - If enabled, the processed IPs are shortlisted for LCI-based UP selection.
  - If not enabled, the processed IPs are shortlisted for session count based UP selection (with or without LCI).
6. If none of the UP IPs present in the response match with the associated Sx peers, then it leads to a session creation failure.
7. For S-GW dynamic UP selection, the DNS client context must be the same as **sgw-service** context.
8. If there is a successful DNS response for S-GW dynamic UP selection, UPs are selected from the DNS dynamic list of UP addresses. If there is DNS failure (DNS response is empty without any UP address or DNS time-out), the UP selection falls back to the statically configured APN profile based user-plane-groups functionality.



- 
- Note**
- Pure S-GW multi-PDNs work with independent DNS-based UP selection.
  - S-GW relocation use cases work with independent DNS-based UP selection during a handover. If user-plane-group is configured under APN-profile, dynamic UP selection takes preference.
  - After the DNS (NAPTR) query is sent, there is a delay of few seconds (equivalent to tx + rx ) to receive the response.
  - If the DNS server is not reachable, session establishment might be delayed upto a maximum of 30 seconds before it uses the legacy method to select an UP.
- 

The following sections describe various scenarios that are associated with the Dynamic UP Selection feature.

#### **P-GW Dynamic UP Selection Having Virtual APN with Associated IP Pool**

This section describes the sequence of operation for P-GW to dynamically select an UP having a virtual APN with an associated IP pool.

1. As part of create session handling, PGW-C selects a virtual APN based on the TAC range.
2. The DNS (S-NAPTR) query is sent to the DNS server based on the configuration of the selected APN.
3. The response that is received from the DNS server is matched for service. The records with matching service fields are considered for selection.
4. The UP IPs that are part of a configured IP pool and present in the response are matched with the associated Sx peers that are based on the UP group of the selected APN.
5. From the matching list, P-GW selects the UP that is least loaded.

### **P-GW Dynamic UP Selection Having Virtual APN without Associated IP Pool**

This section describes the sequence of operation for P-GW to dynamically select an UP having a virtual APN without an associated IP pool.

1. As part of create session handling, PGW-C selects a virtual APN based on the TAC range.
2. The DNS (S-NAPTR) query is sent to the DNS server based on the configuration of the selected APN.
3. The response that is received from the DNS server is matched for service. The records with matching service fields are considered for selection.
4. The UP IPs that are part of any public IP pool and present in the response are matched with the associated Sx peers that are based on the UP group of the selected APN.
5. From the matching list, P-GW selects the UP that is least loaded.

### **S-GW Dynamic UP Selection for Successful DNS Response**

This section describes the sequence of operation for S-GW to dynamically select an UP after receiving a successful response from the DNS server.

1. After an UE in a tracking area (or Cell ID) sends an attach request to S-GW with Dynamic ECGI, RAI-TAI-SAI | TAI-SAI-RAI-ECGI based UP selection feature enabled and the DNS (S-NAPTR) query is sent to the DNS server.
2. S-GW receives the query response from the DNS server, which contains the list of UP IPs.
3. From the list of UP IPs, S-GW selects the UP that is least loaded.

### **S-GW Dynamic UP Selection for DNS Response Time-out**

This section describe the sequence of operation for S-GW to dynamically select an UP after the DNS server time-out or the server sends a negative response.

1. The S-GW sends the DNS (S-NAPTR) query to the DNS server.
2. If there is a DNS server timeout or the server sends a negative response after the DNS (S-NAPTR) query is sent to the DNS server, then S-GW selects an UP from the APN-profile UP group that are configured with static IPs.
3. From the list of UP IPs, S-GW selects the UP that is least loaded.

## **Call flows**

This section includes the following call flows.

**DNS Query Generation and Response Handling Call Flow**

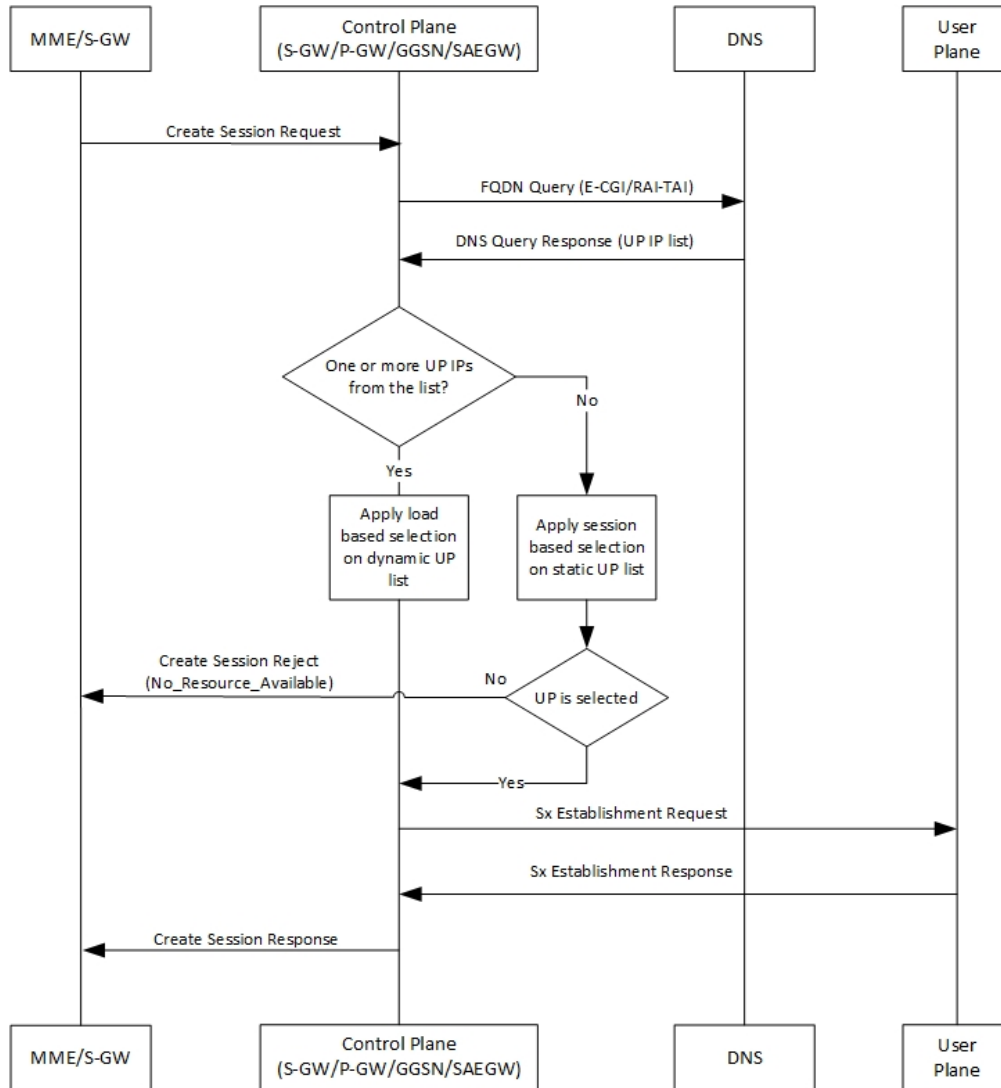

443590

**Table 52: DNS Query Generation and Response Handling Call Flow Description**

| Step | Description                                                                                                                                                                                                                                            |
|------|--------------------------------------------------------------------------------------------------------------------------------------------------------------------------------------------------------------------------------------------------------|
| 1    | MME or S-GW sends a Create Session Request message to the Control Plane (S-GW, P-GW, GGSN, or SAEGW).                                                                                                                                                  |
| 2    | Control Plane (CP) sends an FQDN query (E-CGI or TAI-RAI -SAI or TAI-SAI-RAI-ECGI) to the DNS server.                                                                                                                                                  |
| 3    | CP receives the response to the FQDN query with a list of UP IPs.                                                                                                                                                                                      |
| 4    | <ul style="list-style-type: none"> <li>If there are one or more UP IPs in the received list, CP applies LCI to the dynamic IP list to select an UP IP.</li> <li>Or else, CP applies session count to the static IP list to select an UP IP.</li> </ul> |

| Step | Description                                                                                                                                                                                                             |
|------|-------------------------------------------------------------------------------------------------------------------------------------------------------------------------------------------------------------------------|
| 5    | <ul style="list-style-type: none"> <li>If an UP is selected, CP sends an Sx Establishment Request message is sent to U to step 6).</li> <li>Or else, a Create Session Reject message is sent to MME or S-GW.</li> </ul> |
| 6    | UP responds and sends an Sx Establishment Response message to CP.                                                                                                                                                       |
| 7    | CP sends a Create Session Response message to MME or S-GW.                                                                                                                                                              |

**DNS Query Timeout for Primary DNS Call Flow**

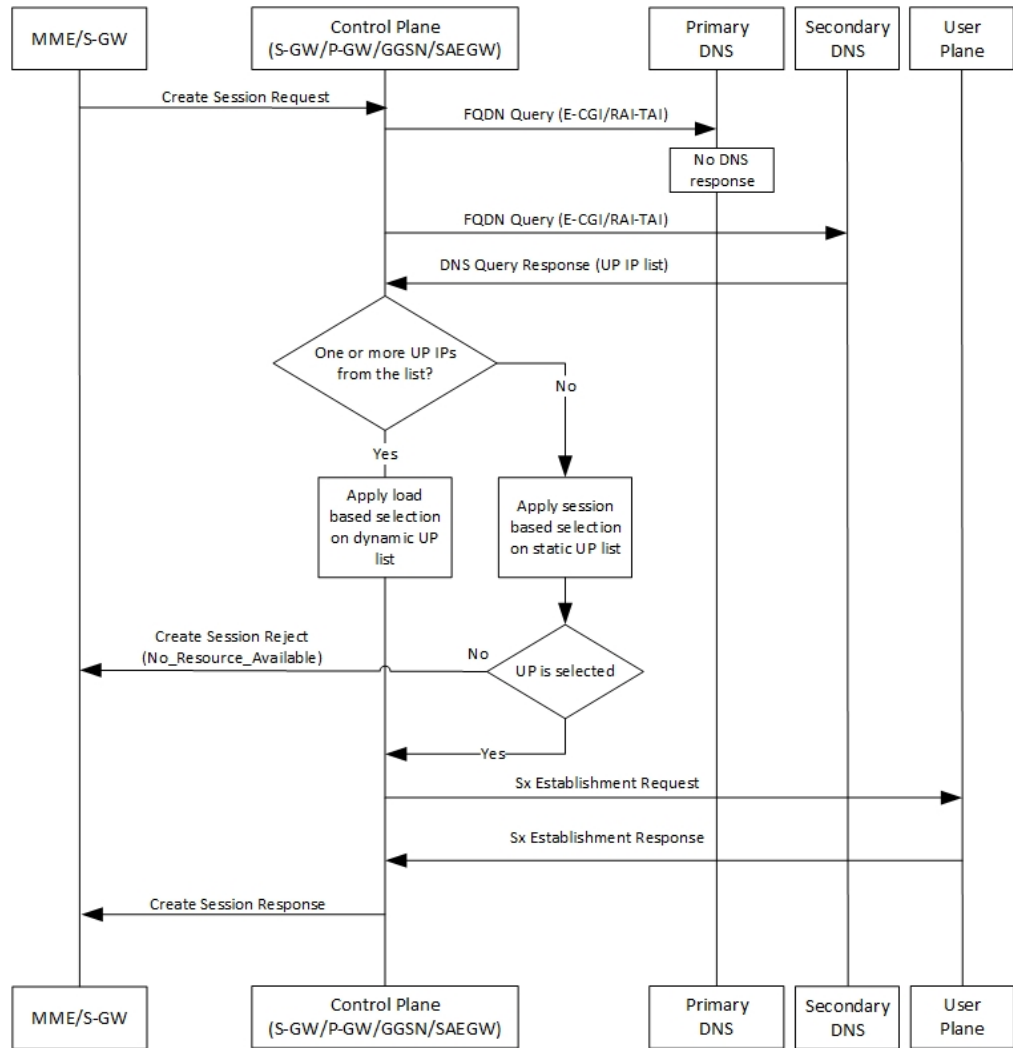

443591

Table 53: DNS Query Timeout for Primary DNS Call Flow Description

| Step | Description                                                                                                                                                                                                                                                |
|------|------------------------------------------------------------------------------------------------------------------------------------------------------------------------------------------------------------------------------------------------------------|
| 1    | MME or S-GW sends a Create Session Request message to the Control Plane (S-GW, P-GW, or SAEGW).                                                                                                                                                            |
| 2    | Control Plane (CP) sends an FQDN query (E-CGI or TAI-RAI-SAI or TAI-SAI-RAI-ECGI) to primary DNS server.                                                                                                                                                   |
| 3    | When there is no response to the query from the primary DNS server due to a time-out, CP re-sends the FQDN query to the secondary DNS server.                                                                                                              |
| 4    | CP receives the response to the FQDN query from the secondary DNS server with a list of UP IP addresses.                                                                                                                                                   |
| 5    | <ul style="list-style-type: none"> <li>• If there are one or more UP IPs in the received list, CP applies LCI to the dynamic IP list to select an UP IP.</li> <li>• Or else, CP applies session count to the static IP list to select an UP IP.</li> </ul> |
| 6    | <ul style="list-style-type: none"> <li>• If an UP is selected, CP sends an Sx Establishment Request message to UP (skip step 7).</li> <li>• Or else, a Create Session Reject message is sent to MME or S-GW.</li> </ul>                                    |
| 7    | UP responds and sends an Sx Establishment Response message to CP.                                                                                                                                                                                          |
| 8    | CP sends a Create Session Response message to MME or S-GW.                                                                                                                                                                                                 |



**DNS Query Timeout for Primary and Secondary DNS Call Flow**

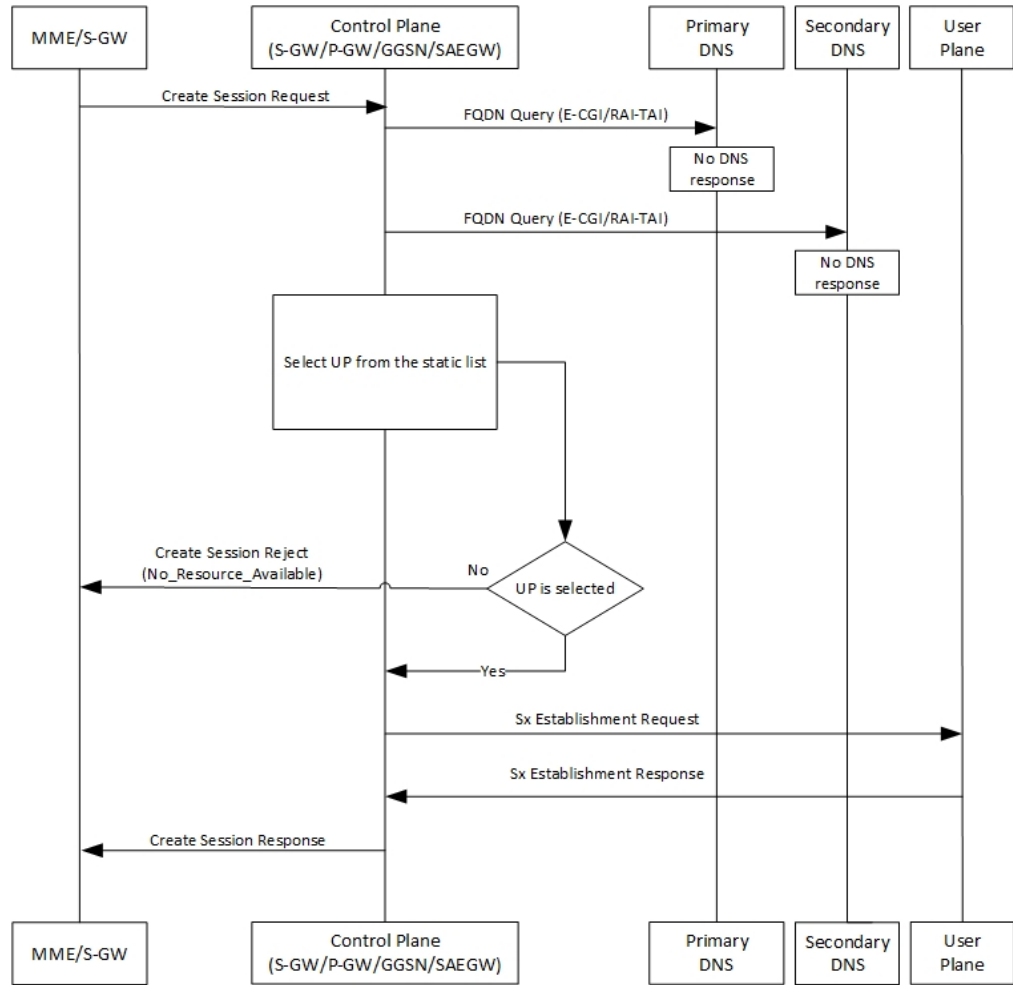

443592

**Table 54: DNS Query Timeout for Primary and Secondary DNS Call Flow Description**

| Step | Description                                                                                                                                                                                                                |
|------|----------------------------------------------------------------------------------------------------------------------------------------------------------------------------------------------------------------------------|
| 1    | MME or S-GW sends a Create Session Request message to the Control Plane (S-GW, GGSN, or SAEGW).                                                                                                                            |
| 2    | Control Plane (CP) sends an FQDN query (E-CGI or TAI-RAI-SAI or TAI-SAI-RAI) to the primary DNS server.                                                                                                                    |
| 3    | When there is no response to the query from the primary DNS server due to a time-out, CP sends the FQDN query to the secondary DNS server.                                                                                 |
| 4    | When there is no response to the query from the secondary DNS server also, CP selects an IP from the list of static IPs.                                                                                                   |
| 5    | <ul style="list-style-type: none"> <li>If an UP is selected, CP sends an Sx Establishment Request message to the User Plane (step 6).</li> <li>Or else, a Create Session Reject message is sent to MME or S-GW.</li> </ul> |

| Step | Description                                                       |
|------|-------------------------------------------------------------------|
| 6    | UP responds and sends an Sx Establishment Response message to CP. |
| 7    | CP sends a Create Session Response message to MME or S-GW.        |

## Limitations

The Dynamic UP Selection feature has the following limitations:

- It is applicable to P-GW, S-GW, and SAEGW only.
- For SR and ICSR, no specific parameters are stored. If **smgr** is reset, the configured values are pushed again from **sessctrl**.
- Any changes to the DNS Server is not considered.
- The number of IPs handled for UP are limited to six. These IPs are a combination of IPv4 and IPv6 addresses.

## Configuring the Dynamic User Plane Selection Feature

This section describes how to configure the Dynamic User Plane Selection feature.

### Configuring FQDN for P-GW or GGSN

To configure FQDN for P-GW or GGSN (Pure-P and Collapsed calls), use the following configuration:

```
configure
 context context_name
 apn apn_name
 user-plane-fqdn
 user-plane-fqdn fqdn_postfix_string type [E-CGI | RAI-TAI -SAI |
TAI-SAI-RAI-ECGI]
 end
```

#### NOTES:

- **user-plane-fqdn**—Enable locally configured FQDN-postfix for dynamic UP selection (DNS-based).
- **E-CGI**—Configure FQDN query type as E-CGI for UP selection.
- **RAI-TAI-SAI**—Configure FQDN query type as RAI-TAI-SAI for UP selection.
- **TAI-SAI-RAI-ECGI**—Configure FQDN query type as TAI-SAI-RAI-ECGI for UP selection.

### Configuring FQDN for S-GW

To configure FQDN for S-GW (Pure-S calls), use the following configuration:

```
configure
 context context_name
 sgw-service sgw-service_name
 user-plane-fqdn
 user-plane-fqdn fqdn_postfix_string type [E-CGI | RAI-TAI -SAI |
```

```
TAI-SAI-RAI-ECGI]
end
```

**NOTES:**

- **user-plane-fqdn**—Enable locally configured FQDN-postfix for dynamic UP selection (DNS based).
- **E-CGI**—Configure FQDN query type as E-CGI for UP selection.
- **RAI-TAI-SAI**—Configure FQDN query type as RAI-TAI-SAI for UP selection.
- **TAI-SAI-RAI-ECGI**—Configure FQDN query type as TAI-SAI-RAI-ECGI for UP selection.

## Boxer Configurations

This section describes the following boxer configurations and restrictions:

1. DNS client must be configured and associated with P-GW and GGSN service.
2. UP FQDN must be configured in APN.
3. IP addresses of the primary and secondary DNS servers must be configured in the ISP context.
4. UP FQDN must be configured in S-GW service for S-GW dynamic UP selection.

## DNS Server Configurations

This section describes the following guidelines and restrictions to configure an external DNS server:

1. DNS must be configured for NAPTR to record for ECFI/CGI/TAI/RAI/SAI, as applicable.
2. NAPTR record must have service field as "**x-3gpp-upf:x-sxb**" for P-GW/SAEGW (Collapsed) and GGSN service, and "**x-3gpp-upf:x-sxa**" for S-GW.
3. NAPTR record must have flags as **a** to indicate that the replacement string is FQDN for A or AAAA records.

The following CLI commands represent a sample DNS server configuration:

```
$ORIGIN 3gppnetwork.org.
$TTL 60 ; Put the Default
TTL in seconds here (Its 1 day currently)
3gppnetwork.org. IN SOA nsbng.3gppnetwork.org. root.3gppnetwork.org.
273 ; serial
7200 ; refresh (2 hours)
3600 ; retry (1 hour)
86400 ; expire (1 day)
43200 ; minimum (12 hours)
)
NS nsbng.3gppnetwork.org.
ns AAAA 3001::41
```

```

;CUPS NAPTR Records Start From Here

;TAI NAPTR Records
tac-lb89.tac-hb67.tac.epc.mnc365.mcc214.3gppnetwork.org. IN NAPTR 1 1 "a"
"x-3gpp-upf:x-sxb" ""
 uplane-address1-v4.3gppnetwork.org.
tac-lb89.tac-hb67.tac.epc.mnc365.mcc214.3gppnetwork.org. IN NAPTR 1 1 "a"
"x-3gpp-upf:x-sxb" ""
 uplane-address1-v6.3gppnetwork.org.
tac-lb89.tac-hb67.tac.epc.mnc365.mcc214.3gppnetwork.org. IN NAPTR 1 1 "a"
"x-3gpp-upf:x-sxa" ""
 uplane-address1-v4.3gppnetwork.org.
tac-lb89.tac-hb67.tac.epc.mnc365.mcc214.3gppnetwork.org. IN NAPTR 1 1 "a"
"x-3gpp-upf:x-sxa" ""
 uplane-address1-v6.3gppnetwork.org.

;RAI NAPTR Records
rac34.lac-lb34.lac-hb12.mnc365.mcc214.3gppnetwork.org. IN NAPTR 1 1 "a" "x-3gpp-upf:x-sxb"
""
 uplane-address1-v4.3gppnetwork.org
.
rac34.lac-lb34.lac-hb12.mnc365.mcc214.3gppnetwork.org. IN NAPTR 1 2 "a" "x-3gpp-upf:x-sxb"
""
 uplane-address1-v6.3gppnetwork.org.

;SAI NAPTR Records
sac1234.lac-lb34.lac-hb12.mnc365.mcc214.3gppnetwork.org. IN NAPTR 1 1 'a'
'x-3gpp-upf:x-sxb' ''
 uplane-address1-v4.3gppnetwork.org.
sac1234.lac-lb34.lac-hb12.mnc365.mcc214.3gppnetwork.org. IN NAPTR 1 2 'a'
'x-3gpp-upf:x-sxb' ''
 uplane-address1-v6.3gppnetwork.org.

;ECGI NAPTR Records
eci-b167.eci-b245.eci-b323.eci-b401.eci.epc.mnc365.mcc214.3gppnetwork.org. IN NAPTR 1 1
"a" "x-3gpp-upf:x-sxb" ""
 uplane-address1-v4.3gppnetwork.org.
eci-b167.eci-b245.eci-b323.eci-b401.eci.epc.mnc365.mcc214.3gppnetwork.org. IN NAPTR 1 1
"a" "x-3gpp-upf:x-sxb" ""
 uplane-address1-v6.3gppnetwork.org.

;CGI NAPTR Records
ci-lb34.ci-hb12.ci.lac-lb34.lac-hb12.lac.ggsn.mnc365.mcc214.3gppnetwork.org. IN NAPTR
1 1
"a" "x-3gpp-upf:x-sxb" ""
 uplane-address1-v4.3gppnetwork.org.
ci-lb34.ci-hb12.ci.lac-lb34.lac-hb12.lac.ggsn.mnc365.mcc214.3gppnetwork.org. IN NAPTR
1 1
"a" "x-3gpp-upf:x-sxb" ""s
 uplane-address1-v6.3gppnetwork.org.

;A Records
uplane-address1-v4 100 IN
A 209.165.200.225

```

```

;uplane-address1-v4 100 IN A
 209.165.200.225

uplane-address1-v4 100 IN
 A 209.165.200.225

;uplane-address2-v4 100 IN
 A 209.165.200.225

;AAAA Records

uplane-address1-v6 100 IN
 AAAA 1::1:111

uplane-address1-v6 100 IN
 AAAA 1111::1:111

;uplane-address2-v6 100 IN
 AAAA 1111::1:111

```

## S6b Configuration (Optional)

This section describes guidelines to configure an external S6b to support custom attribute **aaa-uplane-fqdn** and **fqdn\_post\_fix\_string**.

```

AA-Answer
 apn-config
 uplane-fqdn

```

## Interface

The following sections describe the format of the DNS query and response.

### DNS (S-NAPTR) Query Format

This section describes the format of the DNS (S-NAPTR) query message.



**Important** SAI-based FQDN is proprietary formatted and not as specified in 3GPP TS 23.003 19.4.2 Fully Qualified Domain Names.

| Network Node | Query format                                                                                                                                                                                                                                                                                                                                    |
|--------------|-------------------------------------------------------------------------------------------------------------------------------------------------------------------------------------------------------------------------------------------------------------------------------------------------------------------------------------------------|
| SGW-C        | <p><b>ECGI-based</b></p> <p>eci b1&lt;ECI byte-1&gt;.eci b2&lt;ECI-byte-2&gt;. Eci b3&lt;ECI byte-3&gt;<br/> .eci b4&lt;ECI-byte-4&gt;.eci.epc.mnc &lt;MNC.mcc&lt;MCC&gt;.3gppnetwork.org</p> <p><b>TAI-based</b></p> <p>tac lb&lt;TAC low byte&gt;.tac hb&lt;TAC-high-byte&gt;<br/> .tac.epc.mnc&lt;MNC&gt;.mcc&lt;MCC&gt;.3gppnetwork.org</p> |

| Network Node        | Query format                                                                                                                                                                                                                                                                                                                                                                                                                                                                                                                                                    |
|---------------------|-----------------------------------------------------------------------------------------------------------------------------------------------------------------------------------------------------------------------------------------------------------------------------------------------------------------------------------------------------------------------------------------------------------------------------------------------------------------------------------------------------------------------------------------------------------------|
| PGW-C               | <p><b>ECGI-based</b></p> <p>eci-b1&lt;TAC-byte-1&gt;.eci-b2 &lt;ECI-byte-2.Eci-b3&lt;TAC-byte-3&gt;<br/> .eci-b4&lt;ECI-byte-4&gt;.eci.epc.mnc&lt;MNC&gt;<br/> .mcc&lt;MCC&gt;.3gppnetwork.org</p> <p><b>TAI-based</b></p> <p>tac-lb&lt;TAC-low-byte&gt;.tac-hb&lt;TAC-high-byte&gt;<br/> .tac.epc.mnc&lt;MNC&gt;.mcc&lt;MCC&gt;.3gppnetwork.org</p>                                                                                                                                                                                                            |
| GGSN-C              | <p><b>CGI-based</b></p> <p>ci-lb&lt;CI-low-byte&gt;.ci-hb&lt;CI-high-byte&gt;<br/> .eci.lac-lb&lt;LAC-low-byte&gt;.lac-hb&lt;LAC-high-byte&gt;<br/> .lac.ggsn.mnc&lt;MNC&gt;.mcc&lt;MCC&gt;. 3gppnetwork.org</p> <p><b>RAI-based</b></p> <p>rac&lt;RAC&gt;.lac-lb&lt;LAC-low-byte&gt;<br/> .lac-hb&lt;LAC-high-byte&gt;.lac.ggsn.mnc&lt;MNC&gt;<br/> .mcc&lt;MCC&gt;.3gppnetwork.org</p> <p><b>SAI-based</b></p> <p>sac&lt;SAC&gt;.lac-lb&lt;LAC-low-byte&gt;.<br/> lac-hb&lt;LAC-high-byte&gt;.lac.ggsn<br/> mnc&lt;MNC&gt;.mcc&lt;MCC&gt;.3gppnetwork.org</p> |
| SAEGW-C (Collapsed) | <p><b>ECGI-based</b></p> <p>eci-b1&lt;TAC-byte-1&gt;.eci-b2&lt;ECI-byte-2&gt;<br/> . Eci-b3&lt;TAC-byte-3&gt;.eci-b4&lt;ECI-byte-4&gt;<br/> .eci.epc.mnc&lt;MNC&gt;.mcc&lt;MCC&gt;.3gppnetwork.org</p> <p><b>TAI-based</b></p> <p>tac-lb&lt;TAC-low-byte&gt;<br/> .tac-hb&lt;TAC-high-byte&gt;.tac.epc.mnc<br/> &lt;MNC&gt;.mcc&lt;MCC&gt;.3gppnetwork.org</p> <p><b>SAI-based</b></p> <p>sac&lt;SAC&gt;.lac lb&lt;LAC low byte&gt;<br/> .lac hb&lt;LAC-high-byte&gt;.lac.epc.<br/> mnc&lt;MNC&gt;.mcc&lt;MCC&gt;.3gppnetwork.org</p>                           |

### DNS (S-NAPTR) Response Format

This section describes a sample format of the DNS (S-NAPTR) response message.

```

Query ID : 22290
Type : Response
Question : NAPTR ?
 ci-lb34.ci-hb12.ci.lac-lb34.lac-hb12.lac.ggsn.mnc365.mcc214.3gppnetwork.org.
Answer :
 Name :
 ci-lb34.ci-hb12.ci.lac-lb34.lac-hb12.lac.ggsn.mnc365.mcc214.3gppnetwork.org.
 TTL : 60
 Type : NAPTR
 Order : 1
Preference : 1
 Flags : a
 Service : x-3gpp-upf:x-sxb
 Regexp :
Replacement : uplane-address2.3gppnetwork.org.
 Name :
 ci-lb34.ci-hb12.ci.lac-lb34.lac-hb12.lac.ggsn.mnc365.mcc214.3gppnetwork.org.
 TTL : 60
 Type : NAPTR
 Order : 1
 Preference : 1
 Flags : a
 Service : x-3gpp-upf:x-sxb
 Regexp :
Replacement : uplane-address1.3gppnetwork.org.
Query ID : 44640
Type : Query
Question : A?
 uplane-address2.3gppnetwork.org.
Query ID : 55480
Type : Query
Question : A?
 uplane-address1.3gppnetwork.org.
Query ID : 55480
Type : Response
Question : A?
 uplane-address1.3gppnetwork.org.
Answer :
Name : uplane-address1.3gppnetwork.org.
 TTL : 100

```

```

Type : A
Address : 20.20.20.108
Query ID : 44640
Type : Response
Question : A?
 uplane-address2.3gppnetwork.org.
Answer :
Name : uplane-address2.3gppnetwork.org.
TTL : 100
Type : A
Address : 209.165.200.225

```

## Show Commands

This section describes the supported commands for the Dynamic UP Selection feature.

### **show apn name *apn\_name***

This command displays DNS related information for Pure-P and collapsed calls.

The output of this command can be used to check the following values:

- FQDN of APN
- Type of FQDN

### **show sgw-service name *sgw\_service\_name***

This command displays DNS related information for Pure-S calls.

The output of this command can be used to check the following values:

- FQDN of APN
- Type of FQDN

### **show saegw-service statistics**

Use the **show saegw-service statistics** CLI command to collect the statistics information.

The following is a sample partial output of the **show saegw-service statistics all** and **show saegw-service statistics name *SAEGW21*** CLI commands:

```

Dynamic Uplane Selection Statistics:
 Attempted : x
 Successful : x
 Failure : x
 Peer not Found : x
 Negative DNS response : x
 DNS timed out : x
 Unsolicited UP Selection Response: x
 DNS Query Response post DNS timeout: x

```

The following is a sample partial output of the **show saegw-service statistics all function *sgw*** CLI command:



```

Dynamic Uplane Selection Statistics:
 Attempted: 7
 Successful 4
 Failure: 3
 Mismatch DNS response: 1
 Negative DNS response: 1
 DNS timed out: 1
 Unsolicited UP Selection Response: 1
 DNS Query Response post DNS timeout: 1

```

## Bulk Statistics

### SAEGW Schema

Use this schema to collect the following bulk statistics pertaining to the Dynamic User Plane Selection feature:

- saegw-dyn-up-attempt
- saegw-dyn-up-attempt
- saegw-dyn-up-success
- saegw-dyn-up-success
- saegw-dyn-up-failure
- saegw-dyn-up-failure
- saegw-dyn-up-peer-not-found
- saegw-dyn-up-peer-not-found
- saegw-dyn-up-dns-timeout
- saegw-dyn-up-dns-timeout
- saegw-dyn-up-neg-resp
- saegw-dyn-up-neg-resp

## Multiple UP Group Support

### Revision History

*Table 55: Revision History*

| Revision Details  | Release |
|-------------------|---------|
| First introduced. | 21.25   |

## Feature Description

Remote CUPS allows a progressive configuration rollout on an operator network. You can deploy and activate a pilot or canary version N+1 on a given CP or UPs pool, while the version N configuration is still active on the other CP or UP pool until the operator decides to roll out this N+1 configuration to all the CP or UP pools after the monitoring period.

Use cases for this feature are as follows:

- ECS or ADC configuration update rollout: The ability to test the configuration using one CP or UP pilot, while the other CP or UP uses the old configuration.
- New APN configuration update: Ability to test new APN configuration using a set of CP or UP pilot, while another component uses the old configuration.
- Add or remove the IP pool configuration update.

## Relationships

TAC RAC profile support feature is related to the Multiple UP Group Support feature, which is used to select a test virtual APN.

## Architecture

The following diagram depicts the progressive configuration rollout architecture.

**Figure 47: Progressive Configuration Rollout**

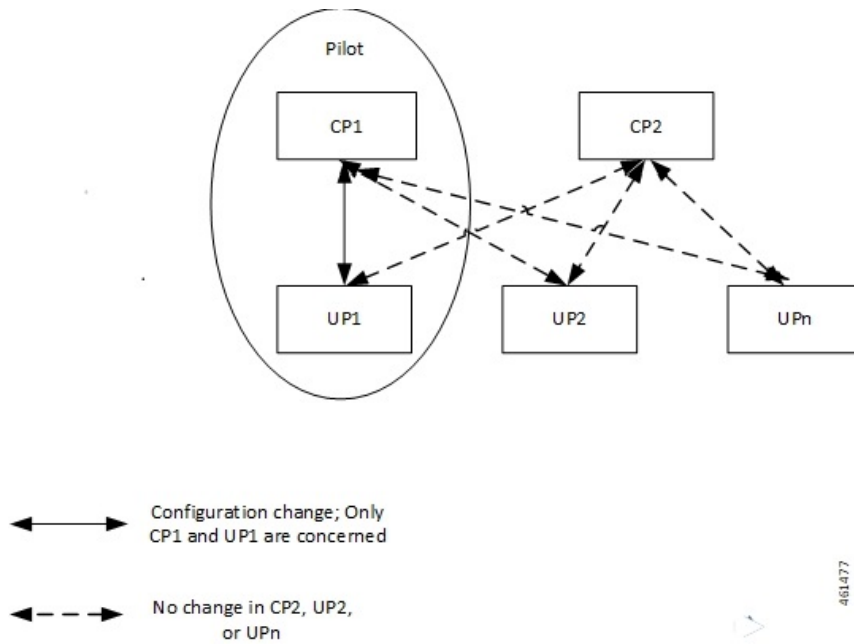

## Components

The following diagram depicts the proposed deployment components.

Figure 48: Proposed Deployment

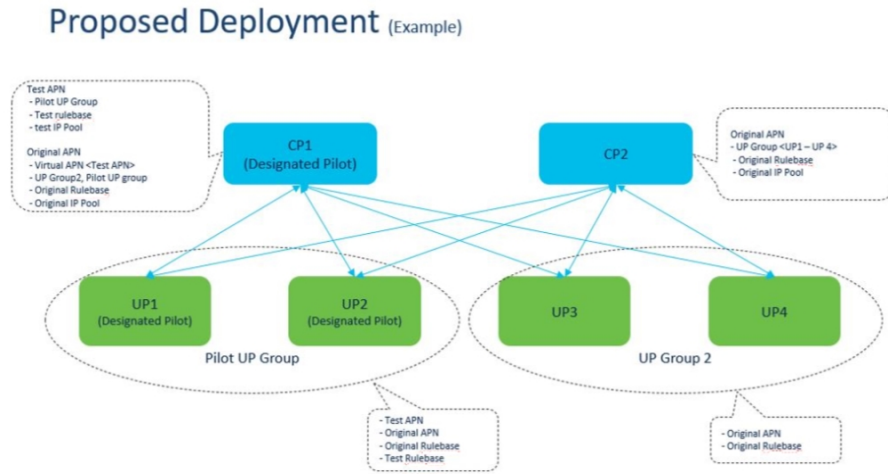

## How It Works

Pilot CP routes the incoming test pilot calls to the pilot UP group.

Pilot CP also routes usual business calls to any UP as per its original deployment. Therefore, this feature supports multiple UP groups under an APN. The first UP group includes the pilot UPs, and the second UP group includes all the other nonpilot UPs. A single UP cannot exist in two UP groups simultaneously. There is a strict 1:1 mapping between UP and the UP group.

## Limitations and Restrictions

The Multiple UP Group Support feature has the following limitations and restrictions:

- You can apply the pilot configuration only at the UP-group level.
- Configure CP and UP independently.
- ECS configuration changes that occur at lower levels like ruledef, Charging Action, and so on, cannot be isolated from the pilot UP. Rule base level differentiation is required.
- Pilot CP and UPs must be designated at deployment. Post deployment designation requires the existing sessions to be cleared.
- If any user group is not attached to any of the APNs, then the corresponding UP nodes must be de-registered and removed from the CP configuration.
- Static-IP-Pools are not supported.

## Configure the Multiple UP Group Support Feature

This section describes how to configure the Multiple UP Group Support feature.

Configuring the Multiple UP Group Support feature involves the following steps:

| Serial Number | Configuration                                                                 | For Pilot Configuration                                                                                                                                                                                                                                                                                                                                       |
|---------------|-------------------------------------------------------------------------------|---------------------------------------------------------------------------------------------------------------------------------------------------------------------------------------------------------------------------------------------------------------------------------------------------------------------------------------------------------------|
| 1             | ECS or ADC configuration<br>(For example, ruledef, rulebase, charging action) | On Pilot CP: Configuration differentiation must be performed at the rulebase level. Changes in configuration entities like ruledef, charging action, and so on, needs duplication.<br><br>On Pilot UP: Corresponding configuration changes must be performed on one or more pilot UPs directly.                                                               |
| 2             | APN configuration                                                             | <ul style="list-style-type: none"> <li>• Create a new APN with desired configuration changes.</li> <li>• Configure the test APN as a virtual APN in the existing APN with required redirecting rules. Alternatively, use MME to redirect calls to the test APN.</li> </ul>                                                                                    |
| 3             | UP group configuration                                                        | <ul style="list-style-type: none"> <li>• Select pilot CP and UPs at the time of deployment.</li> <li>• Enable multiple UP-groups that must be configured for an APN.</li> </ul>                                                                                                                                                                               |
| 4             | IP pool configuration                                                         | <p>New IP pool:</p> <ul style="list-style-type: none"> <li>• Create a new IP Pool and associate it with the test APN.</li> </ul> <p>Update existing IP pool:</p> <ul style="list-style-type: none"> <li>• Perform the configuration changes to the IP pool directly.</li> </ul> <p><b>Note:</b> Change cannot be localized to one or more pilot UPs only.</p> |

### Configuring UP Management Policy

To configure the UP management policy, use the following configuration:

```
configure
 up-mgmt-policy policy_name
 user-plane-group group_name
end
```

#### NOTES:

- **up-mgmt-policy** *policy\_name*—Specify the UP management policy as a string of size 1 to 31 characters.
- **user-plane-group** *group\_name*—Specify the name of the user plane group.

### Selecting UP for Pure-P and Collapsed Calls

To configure UP selection on Pure-P and Collapsed call types, use the following configuration:

```
configure
 context context_name
 apn apn_name
 up-mgmt-policy policy_name
 end
```

### Selecting UP for Pure-S Calls

To configure UP selection on a Pure-S call type, use the following configuration:

```
configure
 context context_name
 apn-profile profile_name
 up-mgmt-policy policy_name
 end
```

#### NOTES:

- **up-mgmt-policy** *policy\_name* must be a string of size 1 to 31 characters.
- You can configure either the APN profile level UP-group or UP management policy.
- For an APN profile, you can configure only a single UP management policy.
- Assign a pool name for the IP address allocation.

## Priority between UP Groups

### Revision History

| Revision Details  | Release |
|-------------------|---------|
| First introduced. | 21.27.2 |

### Feature Description

In CUPS, support is enabled for overlapping IP pools between different UPs which are associated with the same CP. All UP groups that are associated with the same CP get the same IP Pool range. Disjointed IP pools are configured on different CPs that enables assignment of the same IP to UEs at different location. The Virtual Routing and Forwarding (VRF) used on the pools is used to differentiate the traffic for the two UEs.

### How It Works

User Planes are clustered in a UP group based on common characteristics, that is, geographical location. The CP associates these UP groups with specific IP pool such that UPs from same geographical location can never have the same IP Pool range, and UPs from different geographical location can get the same IP Pool range.

This behavior is achieved by introducing a new policy that is called as IP Pool Management Policy. IP Pool Management Policy is applied on APN.

For UP selection, the DNS-based UP selection algorithm is used on UP groups of IP Pool Management Policy. DNS query response list out the eligible UP IP addresses based on TAC/RAC value that is sent in DNS query request. Least load algorithm is then used on eligible UP IP addresses to finally select the UP.

For supporting the overlapping of mobile IP pools, the following requirements are met:

- Support of UP group-specific IP pool
- IP pool chunk allocation to UP if pools are configured specific to any UP group
- DNS-based UP selection algorithm on multiple UP groups

The following is a list of considerations for DNS-based UP selection feature:

- If the UP groups are not configured with specific IP pool/group name, it takes chunks from the public pools when APN is configured with IP Pool Management Policy.
- UP selection occurs among those returned UP IP addresses based on the Least Session UP selection algorithm and UP availability status, even if other UPs in that group are less loaded.
- In DNS query response, the list of UPs received for up to a maximum number of six UP IP addresses can belong to different UP groups when configured in the IP pool management policy and among these, the UP with the least session is selected.
- After the UP selection is complete, if the Sx Establishment is rejected from UP, there are no more reattempts for the same.
- If the IP pool or group name is shared among multiple UP groups, then the IP chunk allocation occurs on a first come first serve basis during UP registration. There is a possibility of unequal distribution of IP pool chunks.
- Configuration of UP Group and IP Pool Management Policy at the same time in APN is not allowed.
- After the UP is selected and if that UP does not have sufficient IP addresses, the call gets rejected as not enough resources being available.
- There is no change that is required at RCM during configuration.
- Configuring disjoint IP Pools across CP instances is required.

### Dynamic APN IP Pool Update

Dynamic APN IP Pool Update takes place when you need to assign or release IP Pool chunks on the UP without breaking the UP association. You should run the below CLI command after any IP Pool related configuration change. This CLI was earlier supported for UP group and IP Pools on APN level. This is now extended for UP group and IP Pools on IP Pool Management Policy level.

```
update ip-pool apn all
```

For more details, see the *Dynamic APN and IP Pool Support* chapter.

## Support of UP Group Specific IP Pool

Configuration of multiple UP groups and UP group-specific IP pools for an APN is possible through IP Pool Management Policy. For any modification on APN with respect to IP Pool, given that UP is already associated,

you must run the Dynamic IP Pool procedure that is explained in the *Dynamic APN and IP Pool Support* chapter of this guide. It will reassign the IP Pool chunks to UP groups.

## IP Pool Chunk Allocation to UP

When the UP associates, UP registration request is sent toward the VPN and the request message has the list of IP pools from which chunk is allocated to UP. That list of IP Pool is constructed now as per the behavior that is depicted in the following diagram.

**Figure 49: Chunk Allocation for UP Groups Associated in APN Through IP Pool Management Policy**

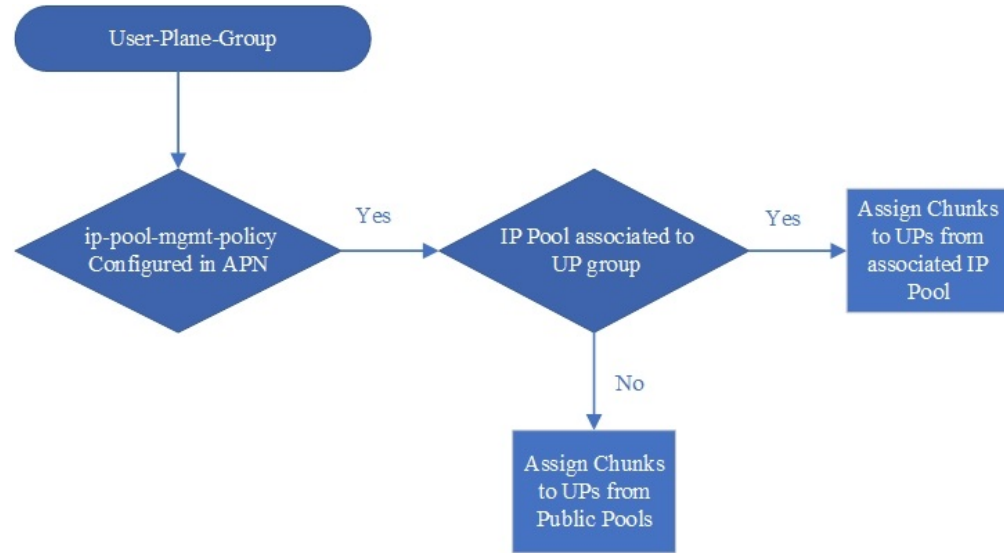

466087

The following table is an example of expected behavior considering G4/G6 as Global/Public IPv4/IPv6 pools, and U4/U6 is the UP group-level IPv4/IPv6 pools.

| UP Group level IPv4 Pools (U-4) | UP Group level IPv6 Pools (U-6) | Expected Behavior |
|---------------------------------|---------------------------------|-------------------|
| F                               | F                               | G4+G6             |
| F                               | T                               | U6+G4             |
| T                               | F                               | U4+G6             |
| T                               | T                               | U4+U6             |

The following diagram indicates APN-level IP pool configuration with UP Group-level IP pool.

Figure 50: APN-Level IP Pool Configuration with UP Group-Level IP Pool

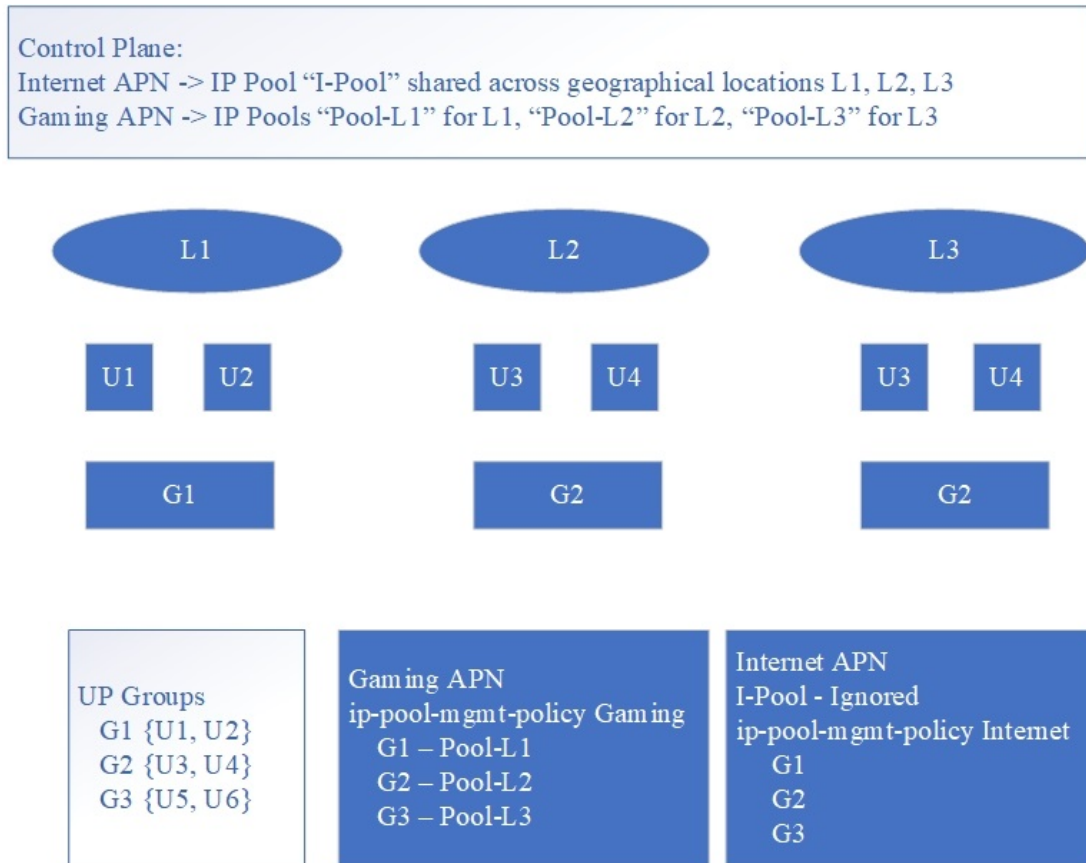

The associated IP pools are updated in the **user-plane-group** configured in **ip-pool-mgmt-policy** without reassociating the UPs. This is possible due to enabling the support of dynamic IP pool update feature for IP pool management policy. UP gets the IP pool chunks based on status of the APN configuration.

Also, during the call establishment, the current ip-pool name that is configured in APN is used with the corresponding ip-pool name for the selected UP group name.

You can update the associated IP pools on "user-plane-group" configured in the "ip-pool-mgmt-policy" without reassociating the UPs. This is possible by extending the support of Dynamic IP Pool Update feature (see *Dynamic APN and IP Pool Support* chapter) for IP Pool Management Policy. UP gets the IP pool chunks based on current snapshot of the APN configuration.

Also, during the call establishment, the ip-pool name that is configured in APN is used with corresponding ip-pool name for the selected UP-group-name.

## DNS-Based UP Selection Algorithm on Multiple UP Groups

DNS is queried with location (TAC/RAC) information. Based on the list of UPs (UP IP addresses) received from DNS, UP selection algorithm filters the UPs from the configured UP group, and then runs the UP-selection algorithm (LCI/OCI or session count) on the resulting set of UPs. This functionality is extended for "ip-pool-mgmt-policy". Filtering is now applied to all UP groups that are part of "ip-pool-mgmt-policy".

The following diagram provides the general flow of events and data for DNS-based UP selection.



Figure 51: Flow of Events and Data for DNS-Based UP Selection

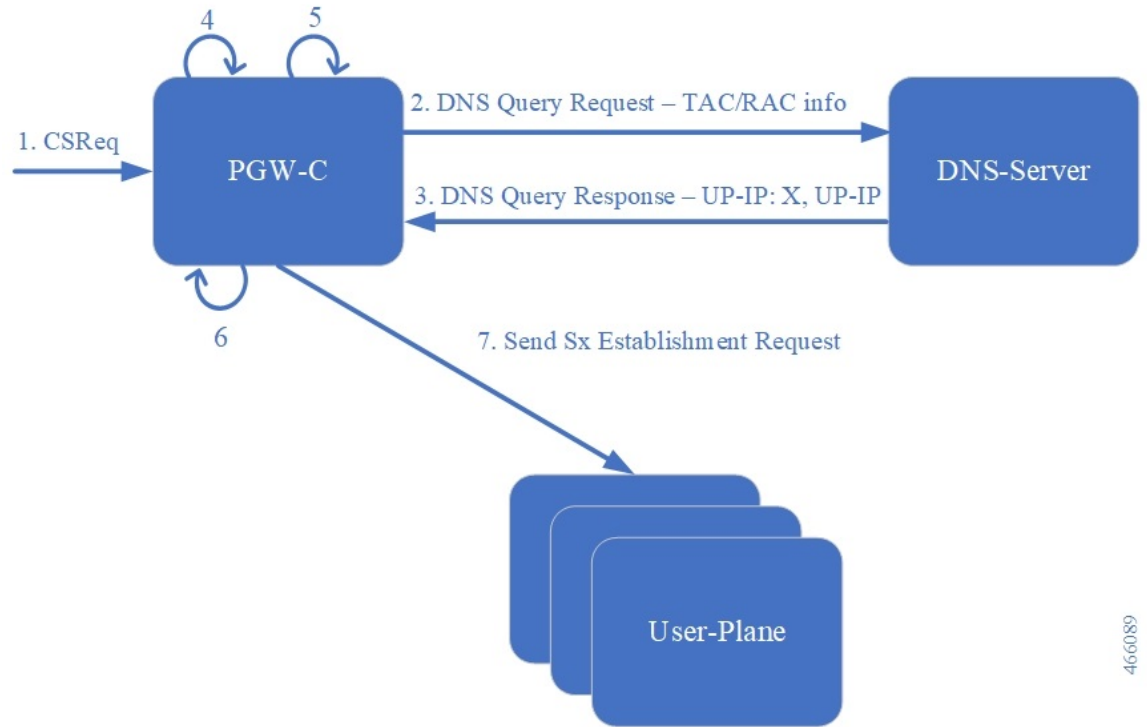

466089

Table 56: General Flow of Events and Data for DNS-Based UP Selection

| Steps | Description                                                                                      |
|-------|--------------------------------------------------------------------------------------------------|
| 1.    | CS Request message is sent to PGW-C.                                                             |
| 2.    | DNS Query Request with TAC/RAC information is sent by PGW-C to DNS server.                       |
| 3.    | DNS Query Response is sent by the DNS server back to the PGW-C.                                  |
| 4.    | The PGW-C finds intersection set of UPs from DNS response and UP group or "ip-pool-mgmt-policy". |
| 5.    | The PGW-C selects UP and UP group from the resulting set.                                        |
| 6.    | The PGW-C selects IP address based on UP group and pool name.                                    |
| 7.    | The PGW-C sends Sx Establishment Request to the User Plane.                                      |

## Limitations

The following are the known limitations of this feature:

- The UP override feature is not supported in the IP Pool Management Policy.

- The maximum number of UPs allowed per TAC/RAC location that are processed by DNS-based UP selection process is six.
- DNS-based UP selection can lead to non-uniform distribution of calls among UP and IP pool exhaustion. This occurs due to TTL as the DNS server is unaware of any session counts in the UP.
- There is no default IP pool management policy like the default UP group.
- Static calls are not supported with IP pool management policy.
- An IP pool management policy can either have disjoint UP groups or if two IP pool management policies share a common UP group, then the other UP Groups of the two policies must be the same. Otherwise, it can lead to uneven load balancing and IP pool exhaustion.
- A maximum number of 20 IP pool management policies are allowed inside each IP pool management policy, for which there are 20 UP groups.
- The maximum number of UP groups that are allowed in CP system wide is 100.
- The maximum number of UPs allowed in a UP group is 100.
- The maximum number of UPs allowed in a CP is 100.

## Configuring IP Pool Management Policy and UP Group with Specific IP Pool

To configure the IP Pool Management Policy, use the following configuration:

```
configure
 context context_name
 apn apn_name
 ip-pool-mgmt-policy policy_name
 end
```

### NOTE:

- **ip-pool-mgmt-policy** *policy\_name*: Specify the IP Pool Management Policy name and must be a string of size 1 to 32 characters.

To configure the UP group with specific IP pool, use the following configuration:

```
configure
 ip-pool-mgmt-policy policy_name
 user-plane-group group_name { ip-address-pool-name ipv4_pool_name |
 ipv6-address-pool-name ipv6_pool_name } [secondary]
 end
```

### NOTES:

- **ip-pool-mgmt-policy** *policy\_name*—Specify the IP Pool Management Policy name as a string of size 1 to 31 characters.
- **user-plane-group** *group\_name*—Specify the UP Group name as a string of size 1 to 31 characters.
- **ip-address-pool-name** *ipv4\_pool\_name*—Specify the IPv4 address pool name as a string of size 1 to 31 characters.

- **ipv6-address-pool-name** *ipv6\_pool\_name*—Specify the IPv6 address pool name as a string of size 1 to 31 characters.

## MOP for Adding and Deleting UP and UP Group

### MOP for Removing UP

1. On the CP, execute the command to block new sessions being placed on that UP and, optionally, clear subscribers with `up-ip-address`. For details, see the *User Plane Node Bring Down Procedure* chapter.



---

**Note** When the **clear subscribers** command is executed on UP, CP will not be informed and will consider the sessions as running.

---

2. Verify that all subscribers are gracefully released or are forced torn down on UP. Also verify that all the sessions have been torn down.
3. On the UP, execute the command to disassociate from CP. It will disassociate the UP from CP and CP will not choose this UP for further sessions.
4. On the CP, execute the command to remove the UP from the UP Group (this will also deregister the BFD monitoring of the UP).
5. Disable the BFD configurations for monitoring at UP and at CP using **no monitor-group** commands.

### MOP for Removing UP Group

1. Use the "MOP for Removing UP" to remove UP from UP group.
2. Delete UP Group from the configurations. Check if UP Group is associated on APN scope or IP Pool Management Policy.
  - APN level
    - Disassociate the UP Group from APN
  - IP Pool Management Policy
    - Disassociate the UP Group from IP Pool Management Policies

### MOP for Adding UP Group

1. Add UP IP address and new UP Group to the configuration.
2. UP Group can either be added on APN scope or the IP Pool Management Policy.
  - APN level
    - Associate UP Group and IP pools on APN
  - IP Pool Management Policy
    - Associate UP Group and IP pools in IP Pool Management Policy

**MOP for Removal and Modification of IP Pool Management Policy on APN**

Modification is done by performing Delete followed by Add.

1. Use the "MOP for Removing UP" to remove UP from UP group
2. Delete the UP Group from the configurations.
  - Disassociate the UP Group from IP Pool Management Policies
3. Can change or remove the IP Pool Management Policy on APN

**Add Operations on UP Group**

Following are the ways of associating IP Pools to a UP Group.

**Adding Both IPv4 and IPv6 Pools to a UP Group**

Use the following configuration to add both the IPv4 and IPv6 pool to a UP Group.

```
configure
 ip-pool-mgmt-policy policy_name
 user-plane-group group_name ip-address-pool-name ipv4_pool_name
 ipv6-address-pool-name ipv6_pool_name
end
```

**Adding Only IPv4 Pool to a UP Group**

Use the following configuration to add only the IPv4 pool to a UP Group.

```
configure
 ip-pool-mgmt-policy policy_name
 user-plane-group group_name ip-address-pool-name ipv4_pool_name
end
```



---

**Note** If APN is IPv4v6 type, then it implies IPv6 prefix and the public pool is used in this situation.

---

**Adding Only IPv6 Pool to a UP Group**

Use the following configuration to add only the IPv6 pool to a UP Group.

```
configure
 ip-pool-mgmt-policy policy_name
 user-plane-group group_name ipv6-address-pool-name ipv6_pool_name
end
```



---

**Note** If APN is IPv4v6 type, then it implies IPv4 address and the public pool is used in this situation.

---

**Delete Operations on a UP Group**

Following are the ways of disassociating IP Pools from a UP Group.

### Removing UP Group

Use the following configuration to remove the UP Group itself.

```
configure
 ip-pool-mgmt-policy policy_name
 no user-plane-group group_name
end
```

### Removing Both IPv4 and IPv6 Pools from UP Group

For deleting both IPv4 and IPv6 pools from the UP Group, reconfigure UP group without any IP Pool.

**Example Configuration:**

```
configure
 ip-pool-mgmt-policy xyz
 user-plane-group G1 ip-address-pool-name v4-pool
 ipv6-address-pool-name v6-pool
end
```

Reconfigure the UP Group by using the following CLI commands:

```
configure
 ip-pool-mgmt-policy xyz
 user-plane-group G1
end
```



---

**Note** If APN is IPv4v6 type, then the public pool will be used for IPv4 and IPv6 address.

---

### Removing Only IPv4 or IPv6 Pools from UP Group

For deleting either IPv4 or IPv6 pools, reconfigure the UP Group accordingly.

**Example Configuration:**

```
configure
 ip-pool-mgmt-policy xyz
 user-plane-group G1 ip-address-pool-name v4-pool
 ipv6-address-pool-name v6-pool
end
```

Reconfigure the UP Group by using the following CLI commands:

```
configure
 ip-pool-mgmt-policy xyz
 user-plane-group G1 ipv6-address-pool-name v6-pool
end
```



---

**Note** If APN is IPv4v6 type, and only IPv6 pool is associated to UP Group, then public pools are used for IPv4 address. And if IPv4 pool is associated to UP Group, then public pools are used for IPv6 address.

---

## Sample Configuration

### Control Plane - 1

```

config
 context egress
 ip pool PRIVATE-1 192.168.0.0/16 private chunk-size 1024 vrf-name vf-name-1
 ip pool PRIVATE-2 192.168.0.0/16 private chunk-size 1024 vrf-name vf-name-2
 ip pool PRIVATE-3 192.168.0.0/16 private chunk-size 1024 vrf-name vf-name-3
 exit
#exit
user-plane-group UP-Grp-1
 peer-node-id ipv4-address 192.168.0.1
exit
user-plane-group UP-Grp-2
 peer-node-id ipv4-address 192.168.0.2
exit
user-plane-group UP-Grp-3
 peer-node-id ipv4-address 192.168.0.3
exit
ip-pool-mgmt-policy xyz
 user-plane-group UP-Grp-1 ip-pool name PRIVATE-1
 user-plane-group UP-Grp-2 ip-pool name PRIVATE-2
 user-plane-group UP-Grp-3 ip-pool name PRIVATE-3
end

config
 context ingress
 apn intershat
 ip context-name egress
 ip-pool-mgmt-policy xyz
 exit
 #exit
end

UP-Grp-1 ==> Region 1 (192.168.0.0/16)
UP-Grp-2 ==> Region 2 (192.168.0.0/16)
UP-Grp-3 ==> Region 3 (192.168.0.0/16)

```

### Control Plane - 2

```

config
 context egress
 ip pool PRIVATE-1 172.16.0.0/12 private chunk-size 1024 vrf-name vf-name-1
 ip pool PRIVATE-2 172.16.0.0/12 private chunk-size 1024 vrf-name vf-name-2
 ip pool PRIVATE-3 172.16.0.0/12 private chunk-size 1024 vrf-name vf-name-3
 exit
#exit
user-plane-group UP-Grp-1
 peer-node-id ipv4-address 192.168.0.1
exit
user-plane-group UP-Grp-2
 peer-node-id ipv4-address 192.168.0.2
exit
user-plane-group UP-Grp-3
 peer-node-id ipv4-address 192.168.0.3
exit
ip-pool-mgmt-policy xyz
 user-plane-group UP-Grp-1 ip-pool name PRIVATE-1
 user-plane-group UP-Grp-2 ip-pool name PRIVATE-2
 user-plane-group UP-Grp-3 ip-pool name PRIVATE-3
end

```

```

config
 context ingress
 apn intershat
 ip context-name egress
 ip-pool-mgmt-policy xyz
 exit
 #exit
end

UP-Grp-1 ==> Region 1 (172.16.0.0/12)
UP-Grp-2 ==> Region 2 (172.16.0.0/12)
UP-Grp-3 ==> Region 3 (172.16.0.0/12)

```

## Verifying IP Pool Management Policy Configuration

Use the following CLI command to check IP Pool Management Policy:

```
show ip-pool-mgmt-policy all
```

Use the following CLI command to check IP Pool Management Policies for any specific UP Group:

```
show ip-pool-mgmt-policy user-plane-group-name group_name
```

Use the following CLI command to check for used and free IP chunks for a pool name:

```
show ip pool-chunks pool-name
```

## User Plane Selection based on TAC Range

### Revision History



**Note** Revision history details are not provided for features introduced before release 21.24.

| Revision Details                                                       | Release   |
|------------------------------------------------------------------------|-----------|
| With this release, support is added for TAC/RAC profile configuration. | 21.25     |
| First introduced                                                       | Pre 21.24 |

### Feature Description

With this feature, User Plane group can be selected based on Access Point Name (APN). The ability to configure Tracking Area Code (TAC) range, in rule combinations in virtual APN selection, helps in giving more flexible network design for location-based User Plane selection for edge computing and other services.

With 21.25 and later releases, support is added to configure TAC and Routing Area Code (RAC) profile in the Control Plane node. Using this feature, it is now possible to select APN based on discrete values of TAC/RAC profile instead of range.

## How It Works

In non-CUPS architecture, Virtual APN selection is based on the following parameters:

- Subscriber IP
- Access-gw-address
- Bearer-access
- cc-behavior
- cc-profile
- domain
- mcc
- msisdn-range
- pdp-type
- rat-type
- roaming-mode
- serv-gw-plmnid

In CUPS architecture, Virtual APN selection is based on Tracking Area Code range with other options, such as cc-profile or mcc/mnc.

To support this feature:

- A new CLI keyword is introduced to accommodate new parameter.
- During call processing, incoming tracking area code is compared with the configured tracking area code range to determine the Virtual APN.

The Tracking Area Code based Virtual APN selection:

- Supports at least 30 tracking-area-code-range configured for Virtual APN.
- Supports overlapping ranges (subset or superset). Duplicate of tracking-area-code-range is not allowed for different priority.
- Selects a Virtual APN based on CLI configuration and User Plane is selected based on Virtual APN for a new call based on the tracking-area-code for that UE.
- Supports a combination of tracking-area-code-range and cc-profile in same priority.

Virtual APN functionality includes storing all the Virtual APN selection rules per real/Gn APN. Every rule has multiple criteria. Rule is identified by preference number. The list of APNs are stored and within APN a rule is identified using preference number.

New parameter has been introduced to pass Tracking Area Code, received in CSReq (TAI).

## Limitations

Following are the known limitations and restriction of this feature.



- New configuration with multiple selection criteria in Virtual APN selection does not work with older builds/releases. User should have separate copies of the configuration for older builds/releases.
- Modify operation on the Virtual APN rule is not supported. User should delete the existing rule and add new rule to achieve modify operation.
- If same option is provided multiple times in the same rule, then the value of later option is considered for selection.
- Total number of Virtual APN rules added across all APNs is limited to 2048. This limitation exists in non-CUPS architecture.
- Upto 1000 TAC/RAC profiles can be configured. Memory usage is based on the number of profiles configured.
- The maximum number of TAC/RAC discrete values supported in a profile are 100. Memory usage is fixed per profile.
- TAC/RAC range or discrete values can overlap between profiles to support maintenance activities like split existing profile or others.
- This is Day-0 and Day-1 configuration.
- Multiple profiles can be associated with an APN.
- There are no changes in existing IP pool functionality.
- There is no specific impact on ICSR or Multi-Sx configurations.
- There is no Service Area Code (SAC) support.
- Pure-S calls aren't supported.
- UP selection requirements are handled in multi-UP group support features.

## Configuring User Plane Selection based on TAC Range

This section provides information about CLI commands available in support of this feature.

### Configuring Tracking Area Code Range

Use the following CLI commands to configure APN for Tracking Area Code range in Control Plane node.

```

configure
 context context_name
 apn apn_name
 virtual-apn preference preference apn apn_name tracking-area-code-range
 tac_range
 end

```

NOTES:

- **tracking-area-code-range** *tac\_range*: Configures APN for Tracking Area Code range. The *tac\_range* is an integer value ranging from 0 to 65535.

## Verifying the Tracking Area Code Range Configuration

Use the following CLI commands to verify if the feature is enabled and the range that is configured for Tracking Area Code.

- **show configuration apn** *apn\_name*
- **show apn name** *apn\_name*

## Configuring Tracking Area Code Profile

From 21.25 and later releases, Tracking Area Code profile can be configured in the Control Plane node. Using this feature, it is now possible to select APN based on discrete values of TAC instead of only range.

The following CLI commands are used to configure Tracking Area Code profile with discrete values and range.

```
configure
 context context_name
 tac-profile tac_profile_name
 tac range X to Y
 tac value
```

NOTES:

- **tac-profile** *tac\_profile*: Configures APN for Tracking Area Code profile. The *tac\_profile* is any range or discrete integer value ranging from 0 to 65535.
- The number of discrete TAC values supported per CLI command is 16.

### Associating TAC Profile with APN

Use the following configuration to associate TAC profile with APN:

```
configure
 context context_name
 apn apn_name
 virtual-apn preference preference apn apn_name tac-profile tac_profile
 end
```

## Verifying the Tracking Area Code Profile Configuration

Use the following CLI commands to verify if the feature is enabled and the range that is configured for Tracking Area Code profile.

- **show configuration apn** *apn\_name*
- **show apn name** *apn\_name*
- **show rule definition** *tac\_profile*

## Configuring Routing Area Code Profile

From 21.25 and later releases, Routing Area Code profile can be configured in the Control Plane node. Using this feature, it is now possible to select APN based on discrete values of RAC profile instead of range.

The following CLI commands are used to configure Routing Area Code profile with discrete values.

```
configure
 context context_name
 rac-profile rac_profile_name
 rac range X to Y
 rac value
```

NOTES:

- **routing-area-code-profile** *rac\_profile*: Configures APN for Routing Area Code profile. The *rac\_profile* is any range or discrete integer value ranging from 0 to 255.
- The number of RAC profile values supported is upto 16.

### Associating RAC Profile with APN

Use the following configuration to associate TAC profile with APN:

```
configure
 context context_name
 apn apn_name
 virtual-apn preference preference apn apn_name
 routing-area-code-profile rac_profile
 end
```

## Verifying the Routing Area Code Profile Configuration

Use the following CLI commands to verify if the feature is enabled and the range that is configured for Routing Area Code profile.

- **show configuration apn** *apn\_name*
- **show apn name** *apn\_name*
- **show rule definition** *rac\_profile*





## CHAPTER 93

# User Plane Node Bring Down Procedure

- [Revision History, on page 823](#)
- [Feature Description, on page 823](#)
- [Preconditions, on page 824](#)
- [How it Works, on page 824](#)
- [Limitations and Considerations, on page 825](#)
- [Configuring UP Node Bring Down Procedure, on page 826](#)
- [Monitoring and Troubleshooting, on page 826](#)

## Revision History



**Note** Revision history details are not provided for features introduced before release 21.24.

| Revision Details | Release   |
|------------------|-----------|
| First introduced | Pre 21.24 |

## Feature Description

The User Plane Node Bring-Down Procedure is a Maintenance Operating Procedure (MoP) that outlines the steps to bring down a specific User Plane (UP) node for maintenance operations. The purpose of this procedure is to disable specific UP node on Control Plane (CP) node while node selection takes place for new incoming sessions.

This feature provides the following functionality:

- Configuration to mark a specific UP unavailable for any new session.
- Option to delete idle subscribers.

## Preconditions

Following are the preconditions to bring down the UP node for maintenance operation:

- The UP and CP nodes must be associated with each other and that the calls land on a specific UP.
- You want to disable the specific UP node for maintenance, from being selected for new incoming calls, and clear existing idle users on that UP node.
- To avoid any call loss, there's a provision of another UP node in the same CP group. If there's only one UP in the group and we disable it for maintenance, the CP rejects the new incoming sessions with disconnect reason as "user-plane-info-not-available".

## How it Works

### Call Flow

#### UP Selection when a UP is Marked Busy Out

The following call flow describes about the UP selection for Pure-P and Collapse call when some UP are marked "busy-out" through the CLI command. Similarly, the UP selection for Pure-S call also takes place.

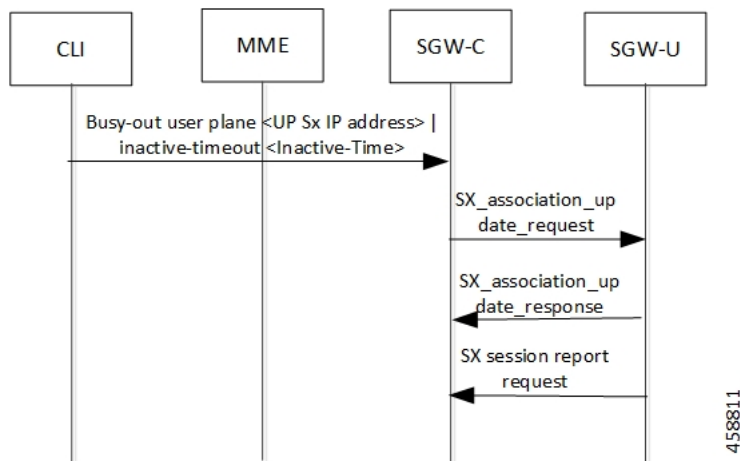

| Steps | Description                                                                                                                                                                       |
|-------|-----------------------------------------------------------------------------------------------------------------------------------------------------------------------------------|
| 1.    | User configures the busy-out configuration from the CP to "busy-out" a specific UP. The inactive time value is optional in the configuration.                                     |
| 2.    | The association state of UP is seen as "B". An association update request message is sent to User Plane with "busy-out" inactive time value if inactive time value is configured. |

## UP Clear Idle Subscribers based on Busy Out Inactivity Timeout

The following call flow describes how inactive sessions (Pure-S call) are cleared on UP when inactive-time is configured in “busy-out” CLI. Other call types also work similarly.

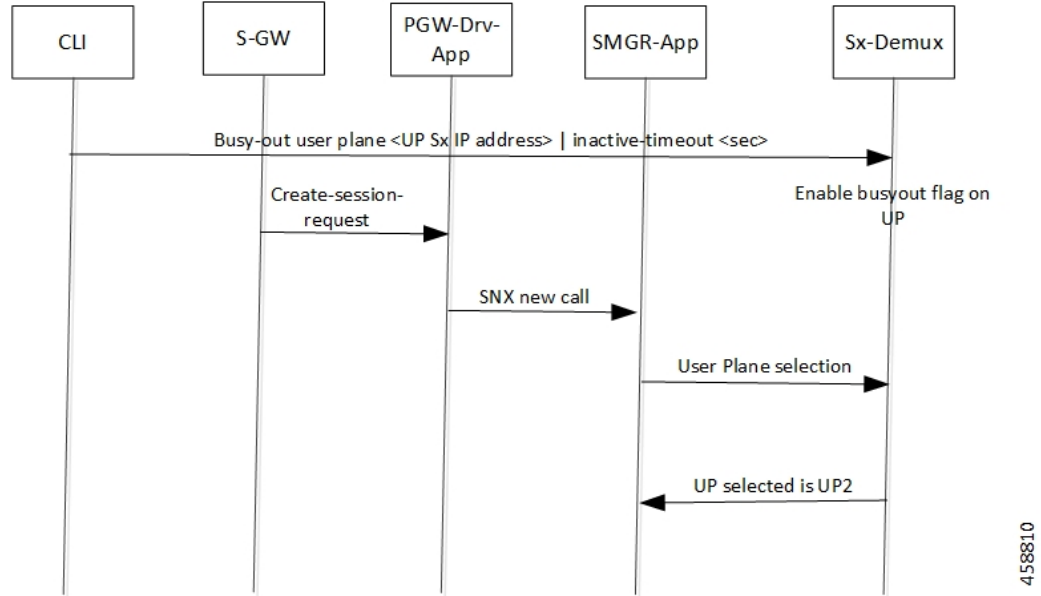

In continuation to the previous call flow, this call flow describes about the clearing of the idle subscriber based on the busy-out inactivity- timeout:

| Step | Description                                                                                                                                                                                               |
|------|-----------------------------------------------------------------------------------------------------------------------------------------------------------------------------------------------------------|
| 1.   | The calls are cleared if they remain idle for the period equivalent to the inactivity time value. The UP can be pulled back to the associated state by configuring the “no” form of the same CLI command. |

## Limitations and Considerations

Following are the known limitations of this feature:

- The multi PDN calls for same UE can fall to different UPs.
- The “busy-out” configuration is done on all Active and Standby CPs.
- Currently, the new IP Pool isn’t added for the specified UP or the belonging UP group so that some of the IP chunks doesn’t get assigned to this UP, leading to loss in capacity.
- All CPs must have the same configuration for “busy-out”. Else, UP uses the latest configuration value triggered from any one of the CPs. Similarly, when you do the “no busy-out” on any of the CPs, UP comes out of “busy-out”.
- To block the UP completely, “busy-out” both its IPv4 and IPv6 addresses using two separate CLIs.
- Currently, there’s a spike in CPU usage when idle timeout triggers for a huge number of calls. The CPU usage eventually goes down when all the calls get cleared out.

# Configuring UP Node Bring Down Procedure

The MoP is applicable only when CPs and UPs are on the same software version where the support of the following “busy-out” CLI is available.

```
configure
 busy-out user-plane { ipv4-address ipv4_address | ipv6-address ipv6_address
} [inactive-timeout inactive_time]
end
```

You must enable the configuration on CP to make a UP unavailable for new sessions and clear the idle sessions which exceeds the time configured in “inactive-timeout”. The *ipv4\_address/ipv6\_address* is the IPv4 or IPv6 address of the UP. “Inactive-Time” is configured in seconds.

If you don’t configure the inactive timeout, then the behavior for the idle session remains unchanged.

## NOTES:

- Existing **clear subscribers saegw-only uplane-address ip\_address no-select-up** CLI command is not extended or reused for “busy-out” logic as it is exec-level CLI which is not fit in the scenario of session-recovery. There is also no other way to roll back the up-selection logic without reassociating the UP using this CLI.



---

**Note** When the **clear subscribers** command is executed on UP, CP will not be informed and will consider the sessions as running.

---

- After “busy-out” CLI command is executed, the UP is removed from UP selection. Existing calls continue to function as usual. No extra operation is performed to the assigned IP pool chunk.
- If you want to bring the same UP after upgrade to handle new calls, you must undo the configuration by executing the **no busy-out user-plane { ipv4-address ipv4\_address | ipv6-address ipv6\_address }** CLI command.
- After “inactive-timeout” is configured for UP in “busy-out” CLI, calls get cleared and some of the assigned pool chunks to this UP gets reclaimed if the other UPs sharing the same IP Pool reach threshold of approximately 70% of the chunks allocated.

## Monitoring and Troubleshooting

Following are the CLI commands available in support of this feature.

### Show Commands and Outputs

#### show sx peers

The output of this CLI command has been enhanced to include the following new association state:



- Busy-Out: Indicates that the given UP is undergoing “busy-out” operations and is not available for new calls.

## show sx peers wide

The output of this CLI command has been enhanced to include the following new fields:

- Last Busy-Out Time: Indicates the time at which UP last stayed in “busy-out” state.
- Last Busy-Out Clear Time: Indicates the time when “busy-out” state in UP was last cleared

Following is a sample output of **show sx peers** CLI command.

```

+---Node Type: (C) - CPLANE (U) - UPLANE
|
|+---Peer Mode: (A) - Active (S) - Standby
|
||+--Association (i) - Idle (I) - Initiated
||| State: (A) - Associated (R) - Releasing
||| (X) - Released (B) - Busy Out
|||
|||+Configuration (C) - Configured (N) - Not Configured (X) - Not Applicable
|||State:
|||
||||+IP Pool: (E) - Enable (D) - Disable (N) - Not Applicable
||||
||||
|||| Sx Service
| No of
|||| ID
| Restart
|||| |
| | Current Max Peer
vvvvv v Group Name State LCI OCI Peer ID Timestamp
| | Sessions Sessions

UABCE 20 default 0 0 209.165.200.225 NONE X X 33554433
2021-04-14:01:25:32
Total Peers: 1

```

```
[local]qvpcc-si# show sx peers wide
```

```

+---Node Type: (C) - CPLANE (U) - UPLANE
|
|+---Peer Mode: (A) - Active (S) - Standby
|
||+--Association (i) - Idle (I) - Initiated
||| State: (A) - Associated (R) - Releasing
||| (X) - Released (B) - Busy Out
|||
|||+Configuration (C) - Configured (N) - Not Configured (X) - Not Applicable
|||State:
|||
||||+IP Pool: (E) - Enable (D) - Disable (N) - Not Applicable
||||
||||+Push Config Status: (C) - Push Complete (P) - Push in Progress (X) - Not Applicable
||||| (E) - Push Error
|||||
|||||+Monitor State: (U) - UP (D) - DOWN (N) - Not Applicable

```

show sx peers wide

```

|||||||
||||||| ID
Restart
||||||| |
| Current Max Peer Config Auto-Config Config Push Recovery
| Last Busy-Out Last Busy-Out Last Busy-Out Config Push
vvvvvvv v Group Name Node ID Peer ID Timestamp
v Sessions Session State Failures Success Start Time End Time
LCI OCI Time Clear Time

UAACECN 20 UP-Grp-1 209.165.200.225 33554435
2021-05-10:12:41:03 0 1 1 NONE 0 0 2021-05-10:12:41:21
2021-05-10:12:41:22 X X 2021-05-10:12:42:50 2021-05-10:12:43:09

Total Peers: 1

```



# CHAPTER 94

## Virtual APN in CUPS

- [Revision History, on page 829](#)
- [Feature Description, on page 829](#)
- [How It Works, on page 830](#)
- [Configuring Virtual APN in CUPS, on page 832](#)

### Revision History



**Note** Revision history details are not provided for features introduced before release 21.24.

| Revision Details                                                | Release   |
|-----------------------------------------------------------------|-----------|
| Support is added for virtual APN selection based on preference. | 21.24.1   |
| First introduced.                                               | Pre 21.24 |

### Feature Description

Access Point Name (APN) is a logical name referring to an external packet data network and/or to a specific service that the subscriber wishes to connect to.

Virtual APNs allow differentiated services within a single APN.

The Virtual APN feature allows a carrier to use a single APN to configure differentiated services. The APN that is supplied by the MME is evaluated by the P-GW along with multiple configurable parameters. Then, the P-GW selects an APN configuration that is based on the supplied APN and those configurable parameters.

APN configuration controls all aspects of a session at the P-GW. Different policies imply different APNs. However, after basic APN selection, internal reselection can occur based on the following parameters:

- Service name
- Subscriber type
- MCC-MNC of IMSI

- Domain name part of username (user@domain)
- S-GW Address

A call received on a particular APN can be redirected to another APN through a Virtual APN, based on a given criteria.

An APN received in the Create Session Request is called Gn APN, and the APN selected as part of a Virtual APN selection is called Gi APN.

Currently, the GGSN, P-GW, SAEGW non-CUPS products support Virtual APN selection that is based on the following modes:

- Local Configuration based
- Gx based
- RADIUS based
- Location based (for GGSN calls)

The P-GW/SAEGW deployed in CUPS mode also supports similar functionality to use the feature in network deployments.

## How It Works

The Virtual APN feature is supported as a forward compatible to CUPS architecture-based P-GW/SAEGW nodes. Since the feature is being supported incrementally, following methods can be used to select Virtual APN for CUPS-based gateway nodes:

- Local Configuration based
- Gx based
- Location based (for GGSN calls)

## Call Flow

The following call flow describes about the various steps for the VAPN Selection.

Figure 52: VAPN Selection

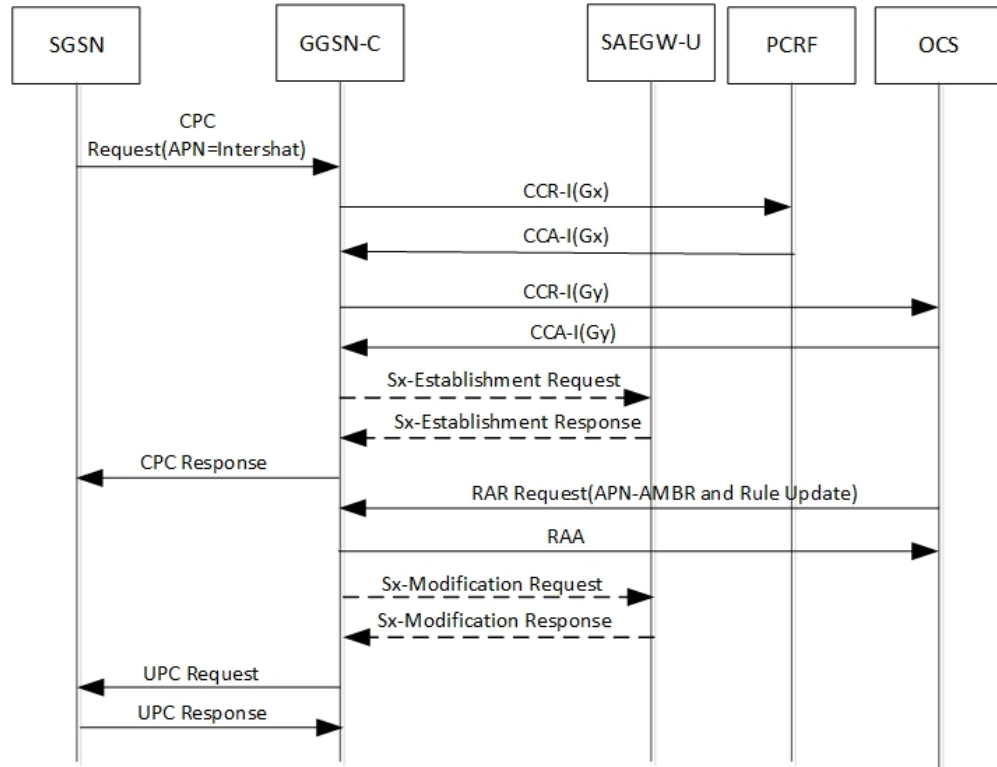

459306

Following steps are performed in the event of the new calls:

Table 57: VAPN Selection call Flow

| Steps | Description                                                                                                                                                           |
|-------|-----------------------------------------------------------------------------------------------------------------------------------------------------------------------|
| 1.    | Extract roaming-mode, bearer-access, serv-gw-plmnd, pdp-type, along with all other required criteria from new create session request (or Create PDP Context Request). |
| 2.    | Extract the service name which is handling this call.                                                                                                                 |
| 3.    | Extract peer address which is sending the call.                                                                                                                       |
| 4.    | Pass all the parameters to the virtual APN selection code/algorithm.                                                                                                  |
| 5.    | It's expected that either select some virtual APN or continue with GnAPN.                                                                                             |

## Limitations

Following are the known limitations and restrictions of this feature:

- If the same option is provided multiple times in the same rule, then later option value is considered for selection.
- New configuration with multiple options for virtual APN selection cannot be applied to older StarOS builds without this feature support. Therefore, you must keep separate copy of the older configuration (without multiple options selected) for older builds.
- Modify operation on the virtual APN rule is not supported. User must delete the existing rule and add new rule to achieve modify operation.
- A maximum of 2048 virtual APN rules can be added across all APNs.

## Configuring Virtual APN in CUPS



**Important** The CLI commands available for non-CUPS Virtual APN feature is applicable in CUPS environment.

Following are sample configuration for:

### 1. Control Plane node:

```

configure
 context context_name
 apn apn_name
 pdp-type ip_address
 bearer-control-mode mixed
 selection-mode sent-by-ms
 ims-auth-service service_name
 exit
 ip access-group acl_group_name in
 ip access-group acl_group_name out
 authentication pap preference chap preference allow-noauth
 ip context-name context_name
 virtual-apn preference preference apn apn_name
 bearer-access-service service_name
 cc-profile cc_profile_index
 [pdp-type { ipv4 | ipv6 | ipv4v6 }]
 [roaming-mode { home | roaming | visiting }]
 [serv-gw-plmnid mccmcc_number mnc mnc_number]
 end
 end

```



**Note** **bearer-access-service** *service\_name*: Specifies the Bearer Access Service (GGSN/P-GW/Other) name. This service name is unique across the context. *service\_name* must be an alphanumeric string of 1 through 63 characters.

**cc-profile** *cc\_profile\_index*: Specifies the charging characteristics (CC)-profile index. *cc\_profile\_index* must be an integer from 1 to 15.

[ **pdp-type** { **ipv4** | **ipv6** | **ipv4v6** } ]: Configures pdp-type rule. The available options include:

- **ipv4**: Configures VAPN Rule for IPv4.
- **ipv4v6**: Configures VAPN Rule for ipv4v6.
- **ipv6**: Configures VAPN Rule for IPv6.

[ **roaming-mode** { **home** | **roaming** | **visiting** } ]: Supports separate PDP context or PDN connection processing for roaming, visiting, and home subscribers.

**serv-gw-plmnid**: Specifies the Serving Gateway PLMN ID.

```
configure
context context_name
 apn apn_name
 pdp-type ipv4 ipv6
 bearer-control-mode mixed
 selection-mode sent-by-ms
 ims-auth-service service_name
 exit
 ip access-group acl_group_name in
 ip access-group acl_group_name out
 authentication pap preference chap preference allow-noauth
 ip context-name context_name
end
```

- For Gx-based Virtual APN selection:

```
configure
context context_name
 ims-auth-service service_name
 policy-control
 diameter encode-supported-features virtual-apn
end
```

- For Location-based Virtual APN Selection for GGSN Calls:

```
configure
context context_name
 apn apn_name
 virtual-apn preference priority apn vapn_name
 routing-area-code-range from start_value to end_value
end
```

## 2. User Plane node:

```
configure
context context_name
 apn apn_name
 ip context-name context_name
 end

configure
context context_name
 apn apn_name
 ip context-name context_name
 end
```





# CHAPTER 95

## VoLTE Support in CUPS

- [Revision History](#), on page 835
- [Feature Description](#), on page 835
- [How It Works](#), on page 836
- [Limitations](#), on page 838

### Revision History



**Note** Revision history details are not provided for features introduced before release 21.24.

| Revision Details | Release   |
|------------------|-----------|
| First introduced | Pre 21.24 |

### Feature Description

VoLTE is now supported for P-GW (Pure-P) and SAE-GW (Collapsed) calls in the UPC CUPS Architecture.

With this release, the following functionalities are supported in this feature:

- SRVCC/CSFB support for VoLTE
- Support Suspend notification procedure
- Support Resume Notification procedure
- P-CSCF address selection.
- P-CSCF restoration.
- AF-Charging-ID support.
- Intelligent Graceful Shutdown support.
- PDN Reactivation support for IMS PDN

- Non-Standard QCI support

**Relationship**

This feature is related to *Priority Recovery Support for VoLTE Calls*.

## How It Works

The functioning of VoLTE in CUPS is implemented at a minimal level in this release.

- Suspend Notification for Pure-P and Collapsed calls
- Resume Notification for Pure-P and Collapsed calls

## Call Flows VoLTE Support

The following section illustrates call flows that are in support of the VoLTE feature.

### Handling Suspend Notifications

The following call flow illustrates Suspend Notifications for Pure-P and Collapsed calls.

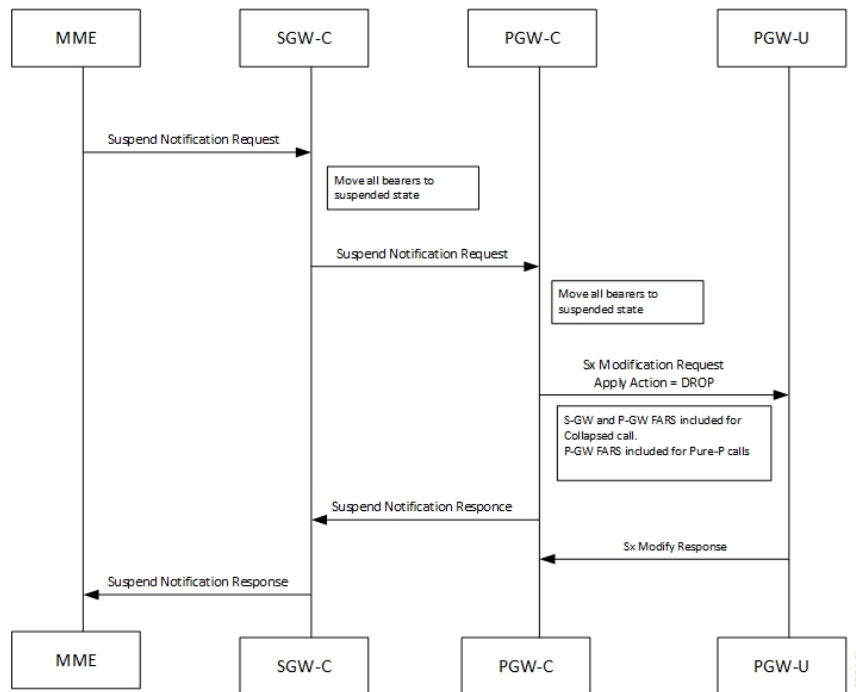

On receiving a Suspend Notification message, the PGW-C requests the PGW-U to discard packets received for the suspended PDN connection by setting the DROP flag in the Apply Action IE of the FARs of the corresponding PFCP session.

As part of the suspend notification, the following actions are sent for uplink and downlink data:

- S-GW uplink FARS - Forward Action

- S-GW downlink FARS - Drop Action
- P-GW uplink FARS - Drop Action
- P-GW downlink FARS - Drop Action

The following conditions are also implemented:

- If SGW receives ULI/RAT/TZ Reporting MBR in Suspended state, all bearers are moved in to active state and forwards MBR to PGW.
- If PGW receives ULI/RAT/TZ Reporting MBR in Suspended state, all bearers are moved in to active state.
- On Receiving suspend notification Session idle timeout is stopped. If PGW receives Empty MBR in Suspended state, all bearers are moved in to active state.

## Handling Resume Notifications

The following call flow illustrates Resume Notifications for Pure-P and Collapsed calls.

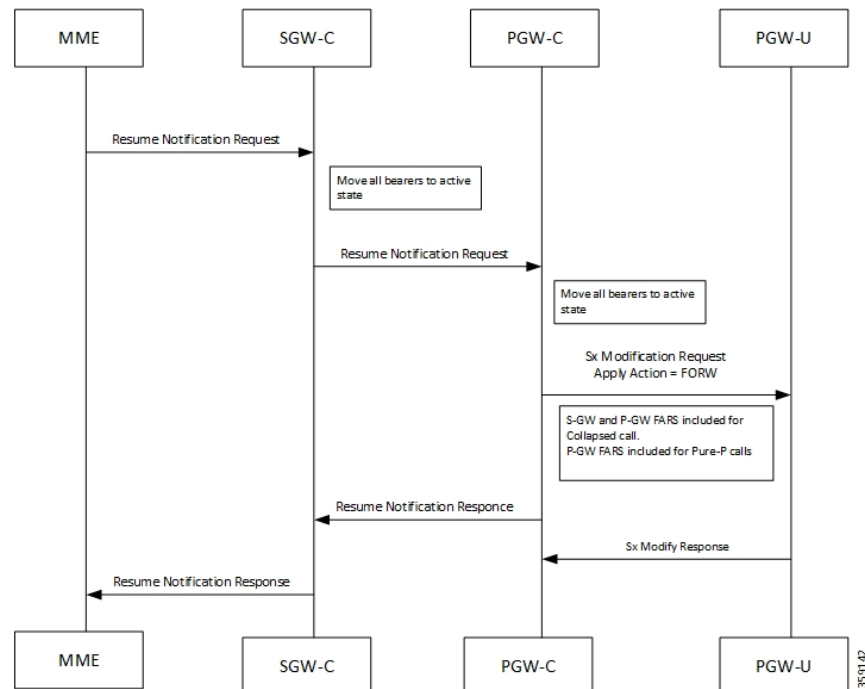

On receiving the request to resume the PDN connection, the PGW-C re-allows the PGW-U to forward the packets for the PDN connection by:

- setting the FORW flag in the Apply Action IE of the FARs of the corresponding PFCP session or
- setting the gate fields in the Gate Status IE of QERs to the value OPEN.

As part of the resume notification, the following actions are sent for uplink and downlink data:

- P-GW uplink FARS - Forward Action
- P-GW downlink FARS – Forward Action

- S-GW uplink FARS - Forward Action
- S-GW downlink FARS – Forward Action



---

**Note** On receiving Resume notifications, Session Idle timeout is restarted.

---

## Limitations

The VoLTE support in CUPS has the following limitations:

- VoLTE Call Identification support.
- Session Recovery enhancement for VoLTE.
- VoLTE statistics
- Multimedia Priority Service support.



## CHAPTER 96

# Volume Reporting over Gx

- [Revision History](#), on page 839
- [Feature Description](#), on page 839
- [How it Works](#), on page 840
- [Configuring VoGx Monitoring Key Range](#), on page 842
- [Monitoring and Troubleshooting VoGx](#), on page 842

## Revision History



**Note** Revision history details are not provided for features introduced before release 21.24.

| Revision Details                                           | Release   |
|------------------------------------------------------------|-----------|
| Trigger-based usage reporting for 3G is supported in CUPS. | 21.25     |
| First introduced                                           | Pre 21.24 |

## Feature Description

The Volume Reporting over Gx (VoGx) feature provides PCRF the capability to make real-time decisions based on the data usage by subscribers.

This feature is implemented using the existing non-CUPS architecture, for Control Plane. This implementation is done by mapping the existing VoGx framework and the CUPS data structures such as FAR, PDR, URR and so on.



**Important** Volume Reporting over Gx is applicable only for volume quota.

## How it Works

The following steps explain how Volume Reporting over Gx works:

1. PCEF, after receiving the message from PCRF, parses the usage monitoring-related AVPs and sends the information to IMSA.
2. IMSA updates the information to ECS.
3. After the ECS is updated with the usage monitoring information from PCRF, the PCEF (ECS) starts tracking the data usage.
4. For session-level monitoring, the ECS maintains the amount of data usage.
5. For PCC rule monitoring, usage is monitored with the monitoring key as the unique identifier. Each node maintains the usage information per monitoring key. When the data traffic is passed, the usage is checked and reported against the usage threshold values.



---

**Note** In releases earlier than 21.22, the monitoring key value was in the range of 0-134217727.  
In 21.22 and later releases, the monitoring key value is in the range of 1-4000000000.

---

6. The PCEF continues to track data usage after the threshold is reached and before a new threshold is provided by the PCRF. If a new usage threshold is not provided by the PCRF in the acknowledgment of an IP-CAN Session modification where its usage was reported, then usage monitoring does not continue in the PCEF for that IP CAN session.

For additional information about this feature, refer the *SAEGW Administration Guide*.

### Supported Standards

The Volume Reporting over Gx feature is based on the following standard: 3GPP TS 29.212 V9.5.0 (2010-06): 3rd Generation Partnership Project; Technical Specification Group Core Network and Terminals; Policy and Charging Control over Gx reference point (Release 9).

## Control Plane Handling for VoGx

### URR Creation during Session Setup

- Sx Session establishment request is used as per the GxSPI framework.
- The Control Plane function sends the list of URRs in the Sx Session Establishment request, along with their references in corresponding PDRs.

### URR Processing in Detach Request

- The URR information will be sent by PGW-U as part of Sx Session Delete Response.
- PGW-C maps these URRs to the corresponding Monitoring-key Buckets and sends the CCR-T containing Usage Report.

### Sx Session Report Request

PGW-U sends the Usage Report for Volume Threshold. PGW-C maps the URRs to corresponding Monitoring-key Buckets and generate the Gx CCR-U accordingly.

### Handling of RAR With Usage Monitoring Related AVPs

When the Usage Monitoring information with the monitoring key associated with Gx alias rule comes in an RAR without any rule associated, the Create URR IE with usage monitoring information (volume or time) is sent towards UP.

## User Plane Handling for VoGx

### Volume Threshold Breach

When data packets match a particular PDR and the PDR has associated URRs that have the measurement method set as Volume, the uplink and downlink usage counters are incremented depending on the PDR source interface type. Once a volume threshold is breached for a particular URR, an Sx Session Report Request message is generated and sent with Usage Report Trigger set as Volume Threshold. All the usage counters of the URRs that are reported is cleared once the message is generated and sent to Control Plane. However, the existing threshold limit will be applicable for further transactions.

## Limitations

The VoGx feature has the following limitations.

- Reporting of usage to PCRF during following event triggers are not supported in CUPS:
  - Trigger
    - PGW\_TRACE\_CONTROL (24)
    - QOS\_CHANGE\_EXCEEDING\_AUTHORIZATION (11)
    - APN\_AMBR\_MODIFICATION\_FAILURE (29)
    - CHARGING\_CORRELATION\_EXCHANGE (28)
    - OUT\_OF\_CREDIT (15)
    - REALLOCATION\_OF\_CREDIT (16)
    - UE\_IP\_ADDRESS\_ALLOCATE (18)
    - UE\_IP\_ADDRESS\_RELEASE (19)
    - APPLICATION\_START (39)
    - APPLICATION\_STOP (40)
    - REVALIDATION\_TIMEOUT (17)
- Trigger-based usage reporting is not supported for 3G in CUPS.

## Configuring VoGx Monitoring Key Range

From Release 21.22 onwards, it is mandatory to define the **monitoring-key urr-id-prefix** entries for all the monitoring keys configured locally in the PCEF as part static and predefined rules.

Use the following configurations to enable the monitoring key range.

```
configure
 active-charging service service_name
 mon-key-urr-list list_name
 monitoring-key value urr-id-prefix urr_id
 end
```

### NOTES:

- **mon-key-urr-list** *list\_name*: Specifies the name of monitoring key list. *list\_name* must be a string of size 1-63.
- **monitoring-key** *value*: *value* must be an integer in the range of 1-4000000000.
- **urr-id-prefix** *urr\_id*: *urr\_id* must be an integer in the range of 1-8388607.
- Multiple monitoring key and URR ID combinations under the list name can be configured. The recommended limit is 2500 entries.
- This CLI command can be configured in both Control Plane and User Plane. After configuring the CLI command in Control Plane, it is mandatory to push the configuration to User Plane using PFD push mechanism. For RCM, it is mandatory to configure **require rcm-configmgr** on User Plane before configuring the CLIs. Both Control Plane and User Plane must be configured through CLI in RCM configuration.
- You should configure only unique monitoring key and URR-ID combinations. These URR-IDs configured through **mon-key-urr-list** should not coincide with the URR-IDs configured through **urr-list**. If such a configuration is attempted, the CLI throws an error.
- If there is a run-time addition of this CLI at Control Plane, it is necessary to push the CLIs using PFD push mechanism so that configurations can be updated at both ends. These configurations will apply next call onwards or at the time of next URR creation.

## Monitoring and Troubleshooting VoGx

This section provides information about the CLI commands available for monitoring and troubleshooting VoGx in CUPS.

### Show Commands and/or Outputs

#### **show active-charging subsystem all debug-only**

The output of this CLI command has been enhanced to include the following fields in support of VoGx feature in CUPS.

- Total Mon-Key Urr Entries in list



- Total Mon-Key lookup success
- Total Mon-Key lookup failure

**show user-plane-service monitoring-key-urr-id-list all**

Use this CLI command to view all the monitoring keys that were pushed from Control Plane to User Plane.





## CHAPTER 97

# VPP Support

---

Vector Packet Processing (VPPMOB) is a mobility-centric solution based on fd.io's VPP, an open source solution. It leverages [fd.io](#) development, particularly in the areas of IP forwarding, routing, and protocols.

- [Revision History](#), on page 845
- [Charging Support](#), on page 846
- [Delay-Charging Via Rule Base](#), on page 846
- [Flow Idle-time Out](#), on page 847
- [HTTP Support](#), on page 847
- [IP Readdressing](#), on page 847
- [DNS Readdress Server List](#), on page 847
- [LTE Handover](#), on page 849
- [Next Hop](#), on page 849
- [PDN Update](#), on page 849
- [Policing](#), on page 850
- [Pure-S Support](#), on page 851
- [Response-based Charging via Service Schema](#), on page 851
- [Response-based TRM via Service Schema](#), on page 851
- [ToS Marking](#), on page 851
- [Volume-based Offload](#), on page 852
- [Supported Functionality](#), on page 852
- [Limitations](#), on page 853
- [Enabling Fast Path in User Plane Service](#), on page 853
- [Enabling VPP on SI Platform](#), on page 853
- [Monitoring and Troubleshooting VPP Fast Path](#), on page 854
- [Support for VPP Configuration Parameters Override](#), on page 854

## Revision History



---

**Note** Revision history details are not provided for features introduced before release 21.24.

---

| Revision Details                                                                                   | Release   |
|----------------------------------------------------------------------------------------------------|-----------|
| With this release, support has been added for VPP ctrl for per flow Fast Path information in CUPS. | 21.27.x   |
| With this release, support has been added for DNS Readdress Server List.                           | 21.25.4   |
| First introduced                                                                                   | Pre 21.24 |

## Charging Support

Usage Reports are notified to the billing server on call deletion or volume/time threshold breach.

When a stream is created on the User Plane, flows – that involve Charging, are associated with charging-specific operations that are set during the stream-creation. The charging counters for all flows – both offloaded and non-offloaded, are maintained on the Fast Path.

During an overflow in the volume threshold, the Fast Path sends a notification with bucket counters (PUSH mode) and in the case of time threshold hit, Applications reads charging counters from Fast Path (PULL mode). The User Plane aggregates these counters with its respective URRs and triggers usage reports over the Sx interface.



---

**Important** In this release, the URR support is there for both Volume and Time Threshold. Multiple SDF and one bearer level URRs are supported.

---

## Delay-Charging Via Rule Base

The flavors of delay-charging supported are as follows:

- Charge-to-application all-packets – All control packets (Handshake, midsession, and tear-down) on flow are charged to the application packet matched charging-action.
- Charge-to-application initial-packets – Handshake packets on flow are charged to the application packet matched charging-action.
- Charge-to-application tear-down-packets – Tear-down packets on flow are charged to the application packet matched charging-action.
- Charge-separate-from-application – All control packets are rule-matched and charged to the highest priority rule.

In all the preceding scenarios only the charging is delayed, but the rule-matching occurs on the packet contents.



---

**Important** • Charge-separate-from-application mid session packets are not supported. For offloaded flow, they continue to match the last matched rule.

---

When you enable the delay-charging feature, the TCP handshake packet hits the rule when it arrives. The TCP handshake packet hits the IP or TCP rule that is based on the configuration. The **show active-charging** CLI command still sees the TCP handshake packet hitting the default rule. This rule is not considered for charging until the first L7 packet arrives. Once the first L7 packet hits the L7 rule, while sending the quota request, the L7 packet and the TCP handshake packet get included in the same L7 RG.

## Flow Idle-time Out

Configurable idle-time out is supported for the maximum duration of 24 hours. In earlier releases, support was available only for specific set of values.

## HTTP Support

Analysis of HTTP traffic and policy matching of such HTTP-based rules is supported in this release. Offloading for HTTP flows is supported only for WebSocket, CONNECT method, or if content is present in request/response.

## IP Readdressing

IP readdressing for IPv4 and IPv6 is supported in this release.

IP readdressing is configurable using the charging-rule or post-processing rule associated with the charging-action.

Streams are created on Fast Path for flows that match these rules along with the IP Readdressing operation set. All these flows - both offloaded and non-offloaded – will have IPv4/IPv6 address set in the Fast path.

## DNS Readdress Server List

Whenever you use an unauthorized DNS server, the request is modified to readdress the DNS IPs to use the authorized servers. **Ruledef** determines if a packet belongs to a DNS query and if the DNS query belongs to a set of authorized DNS servers or not. If the DNS query does not belong to the authorized DNS servers, the flow action is to pick up DNS servers from the **readdress-server-list**.

A **readdress-server-list** is configured under the active charging server. When the flow matches a **ruledef**, the flow action can be configured to use the servers from the **readdress-server-list**.

Configure the **readdress-server-list** under **active-charging service** as follows:

```
configure
 active-charging service service_name
 readdress-server-list name_of_list
 server ipv4_address [port]
 server ipv6_address [port]
```



---

**Note** A maximum of 10 servers can be configured in a **readdress-server-list** and a maximum of 10 **readdress-server-lists** can be configured under active-charging service. Both IPv4 and IPv6 addresses can be configured in the same **readdress-server-list**.

---

Select the **readdress-server-list** from the list using one of the following two ways:

- **Round-robin**—Server selection occurs in a round-robin manner for every new flow. Inactive servers in the list are not considered during the selection.
- **Hierarchy**—The servers that are tagged in this approach are primary, secondary, tertiary, and so on, depending on the order they are defined in the **readdress-server-list**. All flows are readdressed to the primary server as long as it is available. If the Primary server goes down, then flows are readdressed to the secondary server and the same logic recurs. Once, the primary server is active then flows switch back to the primary server for readdressing.

The following CLI command defines the approach for a server selection.

```
charging-action action_name
 flow action readdress-server-list name_of_list [hierarchy | round-robin
]
```

The **round-robin** option is considered as the default option, when no option is provided in the CLI command that is mentioned in the preceding code.

Configure the following CLI command under active-charging service.

```
configure
 active-charging service service_name
 readdress-server-list name_of_list
 server ipv4_address [port]
 server ipv6_address [port]
 consecutive-failures integer_value
 response-timeout integer_value
 reactivation-time integer_value

 charging-action action_name
 flow action readdress server-list name_of_list
 exit
```



---

**Note** Consider the following values to configure the CLI command mentioned in the preceding code.

- **consecutive-failures**—Integer value must range between 1–10. The default value is 5.
  - **response-timeout**—Integer value must range between 1–10000 milliseconds. The default value is 1000.
  - **reactivation-time**—Integer value must range between 1–1800 seconds. The default value is 300.
-

### Readdress Server States

The readdress server states are described as follows:

- Active state—Once configured, all servers are marked as Active.
- Inactive state—If no response is received from the readdressed server, then the server is marked as Inactive.
- Active-Pending state—Once the server is in Active-Pending state, it is available to accept the requests for readdressing. In this state, if a request is readdressed to this server and response is returned from it, then the server-state is changed to Active. Otherwise, it is moved back to Inactive state.

## LTE Handover

The following types of handovers are supported:

- S-GW Relocation for X2 based handovers (OI set to 1).
- S-GW Relocation for S1 based handovers (OI set to 0).
- eNodeB F-TEIDu Update.

For S-GW relocation, the following combinations are supported:

- P-GW anchored call.
- P-GW anchored call to Collapsed call.
- Collapsed call to P-GW anchored call.

## Next Hop

Next hop address for IPv4 and IPv6 is supported in this release.

The Next-Hop address is configurable using the charging-rule or post-processing rule associated with the charging-action.

Streams are created on Fast Path for flows that match these rules along with the Next Hop operation set. All these flows - both offloaded and non-offloaded – will have Next Hop address set in the Fast path.

## PDN Update

PDN Update procedures are supported with VPP in this release.

All flows are onloaded to SM-U whenever Rule Addition/Modify/Removal is received through any Gx procedures. All the packets on these onloaded flows are then sent to SM-U. The flows are also onloaded when transport level marking and charging parameters changes for the flow. These flows are again offloaded on the packet for which rule-match changes, or Transaction Rule Matching (TRM) engages again.

# Policing

The policer configuration uses inputs from the session manager, these inputs are received either from PCRF as AMBR or from flow-level QoS information. The values received from the PCRF is always accepted for session level AMBR policing. But, the flow-level policing is prioritized, if available, and sequentially the AMBR policing is applied. In other words, the policer engine applies the hierarchical policing - first the flow-level/rule bandwidth limiting and then the session level bandwidth limiting.



---

**Note** AMBR modifications during session run-time through RAR or CCA-U is applicable.

---

The input values received from the session manager are pushed into a policer configuration and a policer token bucket. For each direction - uplink or downlink, a new record is created for Policer configuration and Policer token bucket.

The Policer configuration is the reference for the policer engine, and the policer token bucket is used for calculation and restoration of values.

Currently, Policing is supported for AMBR received from PCRF and Rule-level QoS information for dynamic rules. For static and predefined rules, bandwidth limiting is achieved by the bandwidth policy configuration. Extended bit rates configured in bandwidth-policy configuration in Active Charging Service Configuration mode on Control Plane is provided to the User Plane as part of the configuration push mechanism, and same is applied for policing by User Plane. The following is an example configuration of bandwidth policy:

```
configure
 active-charging service ACS
 bandwidth-policy BWP

 flow limit-for-bandwidth id 1 group-id 1

 flow limit-for-bandwidth id 2 group-id 2
 group-id 1 direction uplink peak-data-rate 256000 peak-burst-size 32000
 violate-action discard
 group-id 1 direction downlink peak-data-rate 256000 peak-burst-size 32000
 violate-action discard
 group-id 2 direction uplink peak-data-rate 128000 peak-burst-size 16000
 violate-action discard
 group-id 2 direction downlink peak-data-rate 56000 peak-burst-size 7000
 violate-action discard
 exit
```

## Limitations

In this release, Policing has the following limitations:

- Modification of **bandwidth-policy** is not supported.
- Interaction with other features such as - ITC bandwidth limiting, token replenishment (both APN level and ACL level) is not supported.
- Currently, policer-based statistics are not supported.





---

**Note** As policer statistics are not yet supported, the operator can verify bandwidth limiting using network performance monitoring tools.

---

## Pure-S Support

Pure-S default bearer VPP integration is now supported in the CUPS Architecture. Earlier, Pure-S calls on CUPS were supported using IFTASK. Now, Pure-S call data path also uses VPP.

As part of VPP integration for Pure-S calls, calls on SAEGW-UP will install one bearer stream (3 Tuple – GTPU Service IP address, TEID, VRF id) per direction and also one TEP row per direction is created.

### Supported Functionality:

Supported functionality for Pure-S includes:

- Most procedures for Collision between MME and Network Initiated scenarios (MBR/CBR/UBR/DBR).
- DBCmd and BRCmd commands.
- SAEGW-UP supports movement of IP transport from IPv4 to IPv6, or IPv6 to IPv4 during IDLE to ACTIVE transition, and handover procedures on S1-u interface. Transport selected on S1-u at the time of attach is also supported. For example, eNode handover from IPv4 eNodeB to IPv6 eNodeB.

## Response-based Charging via Service Schema

HTTP Request is charged to the HTTP Response matched charging-action.

## Response-based TRM via Service Schema

The Transaction Rule Matching (TRM) on uplink stream is engaged only after the HTTP response is received.

## ToS Marking

### Feature Description

ToS Marking for IPv4 and IPv6 is supported in this release.

The inner IP ToS marking address is configurable using the charging-rule or post-processing rule associated with the charging-action. The outer IP ToS marking is performed using the QCI-DSCP marking table configured on the control plane.

Streams are created on Fast Path for flows that match these rules along with the operations set. All these flows - both offloaded and non-offloaded – will have IPv4/IPv6 ToS marking set in the Fast path.

## Volume-based Offload

In case of HTTP protocol, the content in request/response (if present) gets offloaded to fastpath for each transaction in a flow. The last packet of the content switches back the stream to passive state and the packet reaches the Session Manager.

## Supported Functionality

The following call flavors are supported in this release:

- Pure-P IPv4/IPv6 calls.
- Collapsed IPv4/IPv6 calls.
- Default bearer.
- Pure-S functionality.
- Dedicated bearer.
- Handovers.

The following functionalities are supported in this release:

- ToS marking of the payload packets (Charging action) and outer GTP-U packets (QCI/QoS mapping table).
- Next hop feature (IPv4/IPv6).
- IP Readdressing feature (IPv4/IPv6).
- Post processing rules with action as discard.
- Post Processing rules with action as Next hop forwarding (IPv4/IPv6).
- Post Processing rules with action as ToS marking (UL, and DL).
- Post Processing rules with action as Readdressing (IPv4/IPv6).
- URR functionality (Gz only) - One SDF, and one bearer level URR.
- Only Gz charging is supported.
- Fragmentation and reassembly is supported in VPP.
- HTTP traffic policy match is supported. HTTP offload support is only for CONNECT and WebSocket requests.
- This release has been validated to support up to 5000 flows across all applications per subscriber. Although this limit is not imposed by the software, it is the recommended operating limit. Exceeding this limit may lead to application failures and so, it is recommended that the following CLI be configured in the Rulebase Configuration mode: **flow limit-across-applications 5000**.

## Limitations

The following functionalities are not supported in this release:

- Gy and Rf are supported independently, however, they both cannot be enabled at the same time for the same subscriber.
- Fast Path CLI can be disabled if it was previously enabled. However, User Plane must be reloaded.
- **VPP crashlog support:** Generation of crash records and mini-core files are supported. Generation of full core files for VPP is not supported.

## Enabling Fast Path in User Plane Service

Use the following CLI commands to enable Fast Path (VPP) in User Plane service.

```
configure
context context_name
 user-plane-service service_name
 associate fast-path service
 end
```

NOTES:

- **fast-path:** Specifies the Fast Path related parameters.
- **service:** Specifies the Fast Path related configurations.

## Enabling VPP on SI Platform

To launch VPP:

1. Log on to host machine, and create an ISO image that contains the file: *staros\_param.cfg*
2. Create a file that has the line: `FORWARDER_TYPE=vpp`
3. Create an ISO file containing the *staros\_param.cfg* file:

```
genisoimage -l -o ssi_vpp.iso -r vppiso/
```

If `genisoimage` is not installed, execute:

```
sudo apt-get install genisoimage
```

4. Stop the VM if it is running:

```
virsh destroy <vm_name>
```

5. If a disk is already attached to the VM that does not have VPP identified as the forwarder, then detach the disk.

Run the **dumpxml** command on the VM to see if there is a disk attached.

To detach the disk, execute:

```
virsh detach-disk <vm_name> hdc -config
```

6. Attach the ISO file that contains the *staros\_param.cfg* file:

```
virsh attach-disk <vm_name> <Path_of_ISO_FILE> hdc -type cdrom -config
```

## Monitoring and Troubleshooting VPP Fast Path

To determine if the flows are offloaded, check for Fast Path statistics in the output of the following CLI commands:

- **show subscribers user-plane-only full all**
- **show user-plane-service all**
- **show user-plane-service statistics analyzer name ip**
- **show user-plane-service statistics analyzer name ipv6**
- **show user-plane-service statistics analyzer name tcp**
- **show user-plane-service statistics analyzer name udp**
- **show user-plane-service statistics analyzer name http**

To determine the per flow Fast Path information, check for Fast Path Info fields in the output of the following CLI command:

- **show subscribers user-plane-only callid *call\_id* flows full**

## Support for VPP Configuration Parameters Override

To configure the VPP Configuration parameters, see the *VPC-SI Administration Guide*. These parameters can be overridden. Ensure that you contact your Cisco account representative to assist in identifying the override values.



## CHAPTER 98

# VRF Support for CUPS

- [Revision History](#), on page 855
- [Feature Description](#), on page 855
- [Configuring VRF](#), on page 857
- [Monitoring and Troubleshooting](#), on page 859

## Revision History



**Note** Revision history details are not provided for features introduced before release 21.24.

| Revision Details | Release   |
|------------------|-----------|
| First introduced | Pre 21.24 |

## Feature Description

The VRF Support for CUPS feature enables association of IP pools with virtual routing and forwarding (VRF). These IP pools are chunked like any pools. The chunks from this pool are allocated to the User Planes (UPs) that are configured to use these pools. As in the existing deployment, VRF-associated pools in CUPS can only be of type—STATIC or PRIVATE.

The chunks from the PRIVATE VRF pool are allocated when the UP comes for registration similar to the normal private pools. The chunks from the STATIC VRF pool are allocated only when calls come up for that chunk, similar to normal static pools.



**Note** VRF limit per UP is 205.

### Overlapping Pools in Same UP

Overlapping pools share and use an IP range. Overlapping pools can either be of type STATIC or PRIVATE. No public pools can be configured as overlapping pools. Each overlapping pool is part of different VRF

(routing domain) and pool-group. Since an APN can use only one pool-group, overlapping pools are part of different APN as well.

Without this functionality, overlapping pools can be configured at CP but chunks from two overlapping pools can't be sent to same UP. That is, the UP can't handle chunks from two different overlapping pools. So, same number of UPs and overlapping pools are required for sharing same IP range.

With this functionality, UP can handle chunks from two different overlapping pools. So, a single UP can handle any number of overlapping pools sharing the same IP range.



---

**Note** Only VRF-based overlapping pools are supported in CUPS. Other flavors of overlapping pools, like NH-based, VLAN-based, and so on, aren't supported in CUPS.

---

The functionality of overlapping pools in same UP includes:

- When a chunk from particular pool is installed on an UP, its corresponding vrf-name is sent along with the chunk.
- The UPs are made VRF-aware of chunks and therefore, UPs install chunks on the corresponding VRFs and the chunk database is populated under the VRFs.
- During call allocation, release, recovery, or any communication towards VPNMgr, the corresponding SessMgr at UP includes vrf-id. This enables VPNMgr to pick the correct chunk for that IP under the provided vrf-id for processing.

## VPNMgr Crash Outage Improvement for IP Pool under VRF

In case of Demux card migration or if VPNMgr goes down, new calls are rejected until VPNMgr rebuilds its database. For enterprise solutions where there are lots of VRFs, the new call impact may be higher than expected.

The Delayed VRF Programming, a CLI-controlled feature, is introduced to reduce the new call impact by delaying the programming of IP pool VRFs during VPNMgr recovery (restart and switchover) scenarios.

### Configuring Delayed VRF Programming

Use the following CLI commands to enable faster recovery of VPNMgr with VRF with IP pool configured on it in CP and UP.

```
configure
 context context_name
 ip vrf vrf_name
 ip delay-vrf-programming-during-recovery
 end
```

#### NOTES:

- By default, the keyword/feature is disabled.
- The CLI keyword is applicable to both CP and UP VRF configurations.
- Enabling the feature on non-IP pool VRFs isn't recommended.

- It's assumed that the IP pool VRF won't have any other control protocols (such as SRP) enabled, which requires TCP connections/kernel interactions.
- During the delayed interval:
  - Any functionality which requires kernel interaction for recovering VRF will not work. No subscriber data outage is expected.
  - Any configuration change related to Route/BGP/BFD/Interface/VRF fails and configuration must be reapplied.

### Change in CLI Syntax

As part of this feature, the syntax of **show ip vrf** *vrf\_name\_string* CLI command is changed for all platforms, including non-CUPS.

Following is the new syntax: **show ip vrf name** *vrf\_name\_string*

Also, all existing optional keyword after **show ip vrf** *vrf\_name\_string* is changed to **show ip vrf name** *vrf\_name\_string*. However, there's no change in output of the CLI commands.

## Configuring VRF

Follow these steps to implement VRF support for CUPS.

### At Control Plane:

1. Associate the IP pool with VRF.
2. Create an APN to use this pool.
3. Associate UP with UP Group to ensure that the UP uses only the specific APN.

If there are overlapping pools, ensure that you create separate APNs for each one of the pools. Also, ensure that different UPs use each of these APNs.

The following is a sample of the CP configuration:

```
context EPC2
 apn mpls1.com
 pdp-type ipv4 ipv6
 bearer-control-mode mixed
 selection-mode subscribed sent-by-ms chosen-by-sgsn
 ims-auth-service iasGx
 ip access-group css in
 ip access-group css out
 ip context-name isp
 ip address pool name PRIVATE
 ipv6 address prefix-pool PRIVATEV6
 ipv6 access-group css6 in
 ipv6 access-group css6 out
 cc-profile any prepaid-prohibited
 active-charging rulebase cisco
 user-plane-group mpls1
 exit
 apn mpls2.com
 pdp-type ipv4 ipv6
 bearer-control-mode mixed
```

```

 selection-mode subscribed sent-by-ms chosen-by-sgsn
 ims-auth-service iasGx
 ip access-group css in
 ip access-group css out
 ip context-name isp
 ip address pool name PRIVATE_1
 ipv6 address prefix-pool PRIVATEV6_1
 ipv6 access-group css6 in
 ipv6 access-group css6 out
 cc-profile any prepaid-prohibited
 active-charging rulebase cisco
 user-plane-group mpls2
 exit

config
 context isp
 ip vrf mpls-vrf-1
 ip vrf mpls-vrf-2
 #exit

 #exit
 cups enable
 ip pool PRIVATE 209.165.200.225 255.255.255.224 private 0 chunk-size 64 vrf mpls-vrf-1
 ip pool PRIVATE_1 209.165.200.225 255.255.255.224 private 0 chunk-size 64 vrf mpls-vrf-2

 ip pool STATIC 209.165.200.226 255.255.255.224 static vrf mpls-vrf-1
 ipv6 pool PRIVATEV6 prefix 8001::aaaa/54 private 0 chunk-size 64 vrf mpls-vrf-1
 ipv6 pool PRIVATEV6_1 prefix 8001::aaaa/54 private 0 chunk-size 64 vrf mpls-vrf-2
 ipv6 pool v6pool2 prefix 2a02:2121:2c4::/46 static 0 vrf mpls-vrf-1
 exit

 user-plane-group mpls1
 peer-node-id ipv4-address 209.165.200.226
 #exit
 user-plane-group mpls2
 peer-node-id ipv4-address 209.165.200.228
 #exit

```

### At User Plane:

It's recommended to configure VRF in UP before chunk is pushed from CP. Else, it leads to the failure of complete IP pool transaction (including chunks that don't belong to the VRF), and retry attempt by CP after some time.

The following is a sample of the UP configurations:

### User-Plane 1:

```

Config
 context EPC2
 sx-service sx
 instance-type userplane
 bind ipv4-address 209.165.200.226 ipv6-address bbbb:aaaa::4
 exit
 user-plane-service up
 associate gtpu-service pgw-gtpu pgw-ingress
 associate gtpu-service sgw-ingress-gtpu sgw-ingress
 associate gtpu-service sgw-engress-gtpu sgw-egress
 associate gtpu-service saegw-sxu cp-tunnel
 associate sx-service sx
 associate fast-path service
 associate control-plane-group g1
 exit

 context isp

```



```

ip vrf mpls-vrf-1
#exit
ip vrf mpls-vrf-2
#exit
apn mpls1.com
 pdp-type ipv4 ipv6
 bearer-control-mode mixed
 selection-mode sent-by-ms
 ip context-name isp
exit
exit
control-plane-group g1
 peer-node-id ipv4-address 209.165.200.227
#exit
user-plane-group default

```

### User-Plane 2:

```

Config
context EPC2
 sx-service sx
 instance-type userplane
 bind ipv4-address 209.165.200.228 ipv6-address bbbb:aaaa::5
 exit
 user-plane-service up
 associate gtpu-service pgw-gtpu pgw-ingress
 associate gtpu-service sgw-ingress-gtpu sgw-ingress
 associate gtpu-service sgw-engress-gtpu sgw-egress
 associate gtpu-service saegw-sxu cp-tunnel
 associate sx-service sx
 associate fast-path service
 associate control-plane-group g1
 exit
exit

context isp
 ip vrf mpls-vrf-1
 #exit
 ip vrf mpls-vrf-2
 #exit
 apn mpls2.com
 pdp-type ipv4 ipv6
 bearer-control-mode mixed
 selection-mode sent-by-ms
 ip context-name isp
 exit
exit

control-plane-group g1
 peer-node-id ipv4-address 209.165.200.228
#exit
user-plane-group default

```

## Monitoring and Troubleshooting

This section provides information regarding the CLI command available in support of monitoring and troubleshooting the feature.

## Show Command(s) and/or Outputs

This section provides information regarding show commands and/or their outputs in support of this feature.

### show ip chunks

The output of this CLI command displays all the chunks in that context.

With Overlapping Pools in Same UP functionality, VRF option is introduced in the CLI, **show ip chunks vrf** *vrf\_name*, that displays only the chunks under that VRF.

- chunk-id
- chunk-size
- vrf-name
- start-addr
- end-addr
- used-addr
- Peer Address

### show ipv6 chunks

The output of this CLI command displays all the chunks in that context.

With Overlapping Pools in Same UP functionality, VRF option is introduced in the CLI, **show ipv6 chunks vrf** *vrf\_name*, that displays only the chunks under that VRF.

- chunk-id
- chunk-size
- vrf-name
- start-prefix
- end-prefix
- used-prefixes
- Peer Address



## CHAPTER 99

# X-Header Insertion and Encryption

- [Revision History, on page 861](#)
- [Feature Description, on page 861](#)
- [How It Works, on page 861](#)
- [Configuring X-Header Insertion and Encryption, on page 862](#)
- [Monitoring and Troubleshooting the X-Header Insertion and Encryption feature, on page 865](#)

## Revision History

| Revision Details                                                                                                                                        | Release  |
|---------------------------------------------------------------------------------------------------------------------------------------------------------|----------|
| Added CLI support to enable spoofing detection in x-header fields using the <b>delete-existing</b> keyword option in the <b>xheader-format</b> command. | 21.28.m0 |
| First introduced.                                                                                                                                       | 21.25    |

## Feature Description

The X-Header Insertion and X-Header Encryption features is collectively known as Header Enrichment. This feature enables in appending headers to HTTP or WSP GET and POST request packets, and HTTP Response packets for use by end applications, such as mobile advertisement insertion (MSISDN, IMSI, IP address, user-customizable, and so on).

## How It Works

### X-Header Insertion

This section provides an overview of the X-Header insertion feature.

Extension header (X-Header) fields are fields that are not defined in RFCs or standards but can be added to protocol headers for specific purposes. The X-Header mechanism allows additional entity-header fields to be defined without changing the protocol, but these fields cannot be assumed to be recognizable by the recipient. The unrecognized header fields must be ignored by the recipient and must be forwarded by transparent proxies.

The X-Header insertion feature enables inserting x-headers in HTTP or WSP GET and POST request packets and HTTP response packets. Operators wanting to insert X-headers in HTTP or WSP request and HTTP response packets, can configure rules for it. The charging-action associated with the rules contain the list of X-headers to be inserted in the packets.

## X-Header Encryption

This section provides an overview of the X-Header Encryption feature.

X-Header encryption enhances the X-header insertion feature to increase the number of fields that can be inserted, and also enables encrypting the fields before inserting them.

If X-Header insertion has already happened for an IP flow (because of any X-Header format), and if the current charging-action has the first-request-only flag set, X-Header insertion won't happen for that format. If the first-request-only flag is not set in a charging-action, then for that X-Header format, insertion continues happening in other suitable packets of that IP flow.

Changes to X-Header format configuration will not trigger reencryption for existing calls. The changed configuration will however, be applicable for new calls. The changed configuration will also apply at the next reencryption time to those existing calls for which reencryption timeout is specified. If encryption is enabled for a parameter while data is flowing, since its encrypted value won't be available, insertion of that parameter stops.



---

**Note** This feature does not support recovery of flows.

---

## Configuring X-Header Insertion and Encryption

This section describes how to configure the X-Header Insertion and Encryption features, collectively known as Header Enrichment.

### X-Header Insertion

*Table 58: Procedure*

| Step | Description                                                                                                                       |
|------|-----------------------------------------------------------------------------------------------------------------------------------|
| 1    | Creating/configuring a ruledef to identify the HTTP/WSP packets in which the X-Headers must be inserted.                          |
| 2    | Creating/configuring a rulebase and configuring the charging-action, which inserts the X-Header fields into the HTTP/WSP packets. |
| 3    | Creating/configuring the X-Header format.                                                                                         |
| 4    | Configuring insertion of the X-Header fields based on the message type in the charging action.                                    |

## X-Header Encryption

**Table 59: Procedure**

| Step | Description                                                                                                                                                           |
|------|-----------------------------------------------------------------------------------------------------------------------------------------------------------------------|
| 1    | X-Header insertion, encryption, and the encryption certificate are configured in the CLI.                                                                             |
| 2    | When the call gets connected, and after each regeneration time, the encryption certificate is used to encrypt the strings.                                            |
| 3    | When a packet hits a ruledef that has x-header format configured in its charging-action, X-Header insertion into that packet is done using the given X-Header-format. |
| 4    | If X-Header-insertion is to be done for fields which are marked as encrypt, the previously encrypted value is populated for that field accordingly.                   |

## Configuring X-Header Insertion

This section describes how to configure the X-Header Insertion feature.

To configure the X-Header Insertion feature:

**Table 60: Procedure**

|               |                                                                                                                            |
|---------------|----------------------------------------------------------------------------------------------------------------------------|
| <b>Step 1</b> | Create or Configure a ruledef to identify the HTTP packets in which the X-headers must be inserted.                        |
| <b>Step 2</b> | Create or Configure a rulebase and configure the charging-action, which inserts the X-header fields into the HTTP packets. |
| <b>Step 3</b> | Create the X-header format as described in <i>Creating the X-Header Format</i> .                                           |
| <b>Step 4</b> | Configure the X-Header format as described in <i>Configuring the X-Header Format</i> .                                     |

### Creating the X-Header Format

To create an x-header format, use the following configuration:

```
configure
 active-charging service ecs_service_name
 xheader-format xheader_format_name
 end
```

### Configuring the X-Header Format

To configure an x-header format, use the following configuration:

```
configure
 active-charging service ecs_service_name
 xheader-format xheader_format_name
 insert xheader_field_name string-constant xheader_field_value | variable
 { bearer { 3gpp { apn | charging-characteristics | charging-id | imei |
```

```

imsi | qos | rat-type | s-mcc-mnc | sgsn-address } | acr | customer-id |
 ggsn-address | mdn | msisdn-no-cc | radius-string |
radius-calling-station-id | session-id | sn-rulebase |
subscriber-ip-address | username } [encrypt] [delete-existing] | http
 { host | url } }
end

```

## Configuring X-Header Encryption

This section describes how to configure the X-Header Encryption feature.

**Table 61: Procedure**

|               |                                                                                                                                                                         |
|---------------|-------------------------------------------------------------------------------------------------------------------------------------------------------------------------|
| <b>Step 1</b> | Configure X-Header Insertion as described in <i>Configuring X-Header Insertion</i> .                                                                                    |
| <b>Step 2</b> | Create or Configure a rulebase, and configure the encryption certificate to use and the reencryption parameter as described in <i>Configuring X-Header Encryption</i> . |
| <b>Step 3</b> | Configure the encryption certificate to use as described in <i>Configuring Encryption Certificate</i> .                                                                 |

### Configuring X-Header Encryption

To configure X-Header Encryption, use the following configuration example:

**configure**

```

active-charging service ecs_service_name
 rulebase rulebase_name
 xheader-encryption certificate-name certificate_name
 xheader-encryption re-encryption period re-encryption_period
end

```

**NOTES:**

- This configuration enables X-Header Encryption for all subscribers using the specified rulebase.
- If the certificate is removed, ECS continues using the copy that it has. The copy is set free once the certificate name is removed from the rulebase.
- Changes to x-header format configuration won't trigger re-encryption for existing calls. The changed configuration will however, be applicable for new calls. The changed configuration will also apply at the next reencryption time to those existing calls for which reencryption timeout is specified. If encryption is enabled for a parameter while data is flowing, since its encrypted value won't be available, insertion of that parameter stops.

### Configuring Encryption Certificate

To configure the encryption certificate, use the following configuration:

**configure**

```

certificate name certificate_name pem { { data pem_certificate_data private-key
pem [encrypted] data pem_pvt_key } | { url url private-key pem { [

```

```
encrypted] data pem_pvt_key | url url } }
end
```

## Verifying the X-Header Insertion and Encryption Configuration

Enter the following command in the Exec Mode to verify your configuration:

```
xheader-format xheader_format_name
```

# Monitoring and Troubleshooting the X-Header Insertion and Encryption feature

This section provides information on the show commands and/or their outputs available to support this feature.

### **show active-charging charging-action statistics name**

The output of this command displays statistics for X-Header information.

- XHeader Information:
  - XHeader Bytes Injected
  - XHeader Pkts Injected
  - IP Frags consumed by XHeader
  - XHeader Bytes Removed
  - XHeader Pkts Removed

### **show active-charging rulebase statistics name**

The output of this command displays the Header Enrichment statistics.

- HTTP header buffering limit reached







## APPENDIX **A**

# IP Pool Planning Guidelines

---

- [IP Distribution in CUPS Architecture, on page 867](#)
- [UP Group Concept, on page 867](#)
- [When to Add New Pool, on page 868](#)
- [IP Pool Fine-tuning Parameters, on page 870](#)
- [Dynamic IP Pool Planning Guidelines, on page 871](#)
- [Static IP Pool Guidelines, on page 873](#)
- [Implications of Taking Very Big Chunk Size, on page 873](#)

## IP Distribution in CUPS Architecture

If IP Pool is configured in UP, it becomes tightly coupled to the UP. If the IP pool is unused to a large percentage, it becomes a waste of resources. UPs, which are short of IP resources could benefit from the unused resources, if they are available to them. Similarly, if one UP becomes unreachable, the IP range allocated to it can't be reused. To overcome this limitation, IP chunking mechanism is introduced.

In CUPS architecture, IP pools are configured in the CP, and CP is responsible for the IP Pool management. Any IP pool configured on the CP is divided into chunks of configured size. During the UP-registration process, the CP identifies all the APNs which are being served by that particular UP and the associated IP pool configurations in each APN. The CP allocates the chunks from these IP pools to the UP. CP monitors the chunk usage at per pool level for each UP every **chunk-threshold-timer** second, and if the chunks threshold is reached, it allocates new chunks to the UP. Similarly, if certain IP chunks in the UP aren't utilized, and if CP doesn't have enough free chunks in reserve for that pool, CP withdraws those IP chunk resources from the respective UPs.

In CUPS architecture, IP pools aren't considered as resource/criteria for UP selection. To avoid uneven load distribution across UPs, the operator must ensure that sufficient IP chunks are available for all APNs and UPs in an UP Group.

## UP Group Concept

When the UP associates with CP, chunks from IP pool associated with APN are distributed to the UP. UP in turn is associated with single UP Group, which is tied to APN. So, the chunks from IP pool that are configured as part of APN are distributed to the UPs belonging to the UP group associated with that APN. Therefore, the size of UP group must be kept in consideration while planning the pool size and chunk size.



---

**Note** UP can only be part of single UP Group. You must avoid adding an UP to two UP groups, because it can cause undefined behavior.

---

## Default UP Group

When an APN doesn't have UP Group configured explicitly, they are considered part of default UP group. A default UP Group is used mostly for consumer traffic where the APNs are too large catering to large number of subscribers and operating on large IP pool.

## Specific UP Group

To direct traffic of specific APN to selective set of UPs, specific UP Group is used. For example, consider a case of enterprise subscribers where APN and IP pool are small (order of size 256). In this case, it's better not to chunk the pool and dedicate the entire APN to the UP group consisting of only one UP. Similarly, consider very large deployments consisting of large APNs and 20+ UPs. Even in this case, there's no large APN that it requires all 20 UPs to serve it. To better utilize chunking mechanism of IP pools, divide these UPs and APNs into some specific UP groups.

For example, consider a case where you have 20 UPs and require the UPs to serve 100k subscribers each. Consider that there are 25 APNs each having a pool of size 16 K with chunk size of 1k, and six APNs of size 64k, and chunk size of 1k. In this case, to utilize IP pools better, you can create two UP Groups, UP group-1 with four UPs to cater 25 small APNs and UP group-2 consisting of 16 UPs and six large APNs.

## When to Add New Pool

When the amount of free chunks left for an APN are less than the number of UPs in the UP Group, and if the selected UP has all chunks fully utilized (that is, no free chunks left), then it leads to uneven load distribution. Also, UP selection algorithms are overridden and IP is given from the UP, which has a chunk available.

This scenario is illustrated in the following figure:

Figure 53: When to Add New Pool

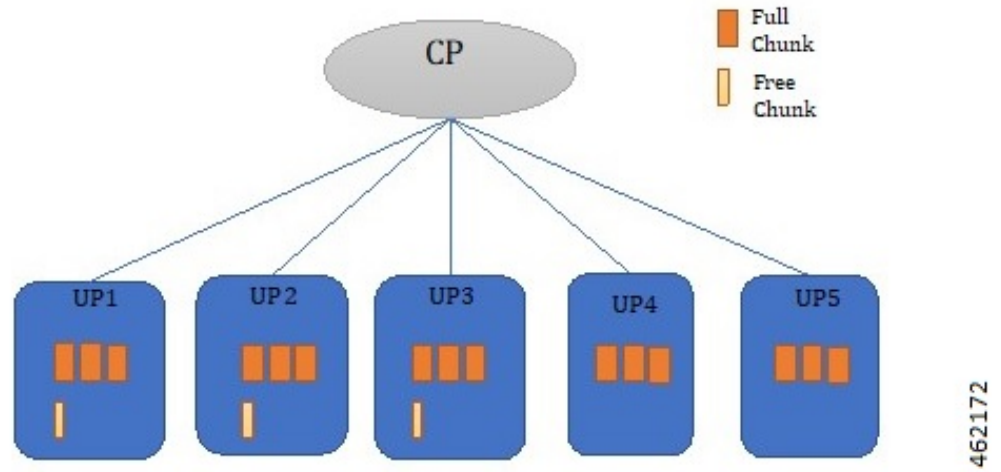

Add more pools in that APN to avoid uneven load distribution, and chunking should be done to make chunks as even as possible.

Figure 54: Scenario After the New Pool is Added

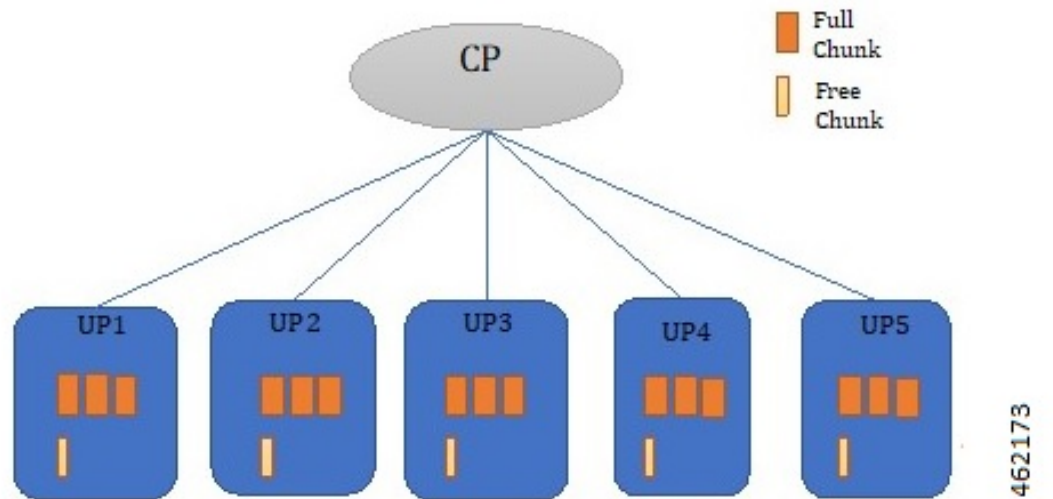

**Note** We recommend you to plan the dimensioning in advance for future use, and add more chunks to avoid uneven load distribution.

# IP Pool Fine-tuning Parameters

## Threshold Timer

CP pushes or removes chunk to/from all UPs periodically. The periodicity is configured with the help of **chunk-threshold-timer**. If the UP has used more than 70% of address allocated from a pool, then a new chunk is pushed to the UP. Similarly, If the UP is underutilizing IP pool resources, then CP pulls back unused chunk from the UP. Removal of chunk is also dependent on other factors described in the section [Chunk Withdrawal](#).

## Chunk Withdrawal

CP withdraws chunk from UPs which are underutilizing that pool when CP has free chunks less than **min-chunks-threshold-per-pool** at periodic interval. If the UP is using less than 40 % of allocated IP address from the pool, and if the UP has more than two free chunks available, then a chunk is withdrawn from it.

## Initial Chunk Pushed

Initial chunk pushed to each UP can be controlled using **cups max-user-plane** keyword, and it works at context level. Initial chunks are pushed depending on the following factors:

- Total free chunks in pool (command **show ip pool** displays this value)
- Total chunks in pool (value configured in **cups max-user-planes** CLI). By default, the value is set to 10 for max-user-planes.
- Three chunks

### Example 1:

The CUPS **max-user-plane** CLI command is used to decide how many initial chunks are pushed to the UP when it registers. The number of initial chunks pushed depends on the following factors:

- If chunks < **max-user-plane** value, then one chunk is pushed.
- If chunks are more, then it's minimum of (chunks/**max-user-plane**, 3).

Default value of max-user-plane is 10.

Consider that you have eight chunk pools, and want to use four UPs in deployment. You may be interested to give all chunks directly to all UPs. You can do the same by setting **max-user-plane** as 4. Similarly, if you want to have eight UPs in deployment, you can configure the value as 8, and only one chunk is pushed to an UP.

Moreover, it provides some extra chunks which can serve as buffer to cater to sudden surge of subscribers. This surge of subscribers might exceed the normal threshold chunk replenishment rate. Consider that there's one pool with 32 chunks and four UPs of 2k size, and incoming subscribers rate is 2k per minute. If you want to have extra buffer chunk, that is, guard chunk to avoid load imbalance due to incoming subscribers being higher than chunk replenishment rate in small window, then you can use **max-user-plane** CLI. If you don't want to use this CLI, then you can set it to 1000, and always one chunk is pushed.

## Chunk Size

Chunk size should be planned considering both CEPS and evenness of chunk with respect to number of UPs in UP Group. Configuring too large chunks can lead to unevenness among UPs with respect to IP addresses. But, if the chunk is too small, then chunk replenishment rate might be lower than incoming subscribers. Low chunk replenishment rate leads to UP override or load imbalance.

# Dynamic IP Pool Planning Guidelines

## Chunking Guidelines

Chunking should be planned in consideration with the UP-Group scale. There are associated implications of a too large or too small sized chunk, so maintaining a good balance is important.

- Smaller chunk size reduces the imbalance between the chunk distribution among the UPs. But, very small chunk sizes lead to faster chunk exhaustion at the UP, and negatively impacts the CEPS rate.
- Very large chunk size may result in uneven distribution of chunks among the UPs. This issue may lead to UP override or load imbalance on certain UPs where no IPs are available, while IP address is still available with another UP.

The following shows a sample configuration where better IP pool resource planning is recommended:

- **IPv6 pool:** Poolv6\_example\_1 pool\_group\_example1 x:x:x:x::/48 chunk\_size = 8192
- **IPv6 pool:** Poolv6\_example\_1 pool\_group\_example1 x:x:x:x::/48 chunk\_size = 8192
- **UPs associated with APN:** UP1, UP2, UP3, UP4, and UP5
- **Threshold timer:** 60 secs
- **Incoming Subscriber rate per UP:** 6k subscribers per minute

(Considering that only one IP pool group is attached to the APN, which this UP group is serving)

Now, both IP pools have 65536 IP addresses.

**Case of chunk size being too large** Consider that addresses are divided into eight chunks to be distributed among five UPs. This means that not all UPs can get the comparable number of IP resources, and some UPs exhaust their IP resources sooner than the others.

Once IP resources reach exhaustion, UP override or load imbalance happens on such UPs. In this example, it can start happening after the usage of around 40960 addresses per pool or around 81920 addresses at IP pool group level.

- Pool1: (**UP1** = 8192 + 8192, **UP2** = 8192 + 8192, **UP3** = 8192 + 8192, **UP4**=8192, **UP5**=8192)
- Pool2: (**UP1** = 8192 + 8192, **UP2** = 8192 + 8192, **UP3** = 8192 + 8192, **UP4**=8192, **UP5**=8192)

**Case of chunk size being too small:** Consider same pools as described in the previous section are designed with chunk size of 512 with 128 chunks. In that case,

- Pool1: (**UP1** = 26 \*512, **UP2** =26\*512, **UP3** = 26\*512, **UP4**=25\*512, **UP5**=25\*512)
- Pool2: (**UP1** = 26 \*512, **UP2** =26\*512, **UP3** = 26\*512, **UP4**=25\*512, **UP5**=25\*512)

Although in this case, UP override or load imbalance due to chunk imbalance happens after 128000 (50 chunks\*512 size\*5 UPs) addresses is used, each UP has only 1k address per minute from each UP. Since the threshold timer is 60 sec, but incoming subscriber rate is 6k, each UP sees load imbalance for 5k subscribers.

**Case of Correct design:** Better design is to divide the IP pool into chunk size, for example, 4096 IP addresses. This design provides the CP with 16 chunks to distribute to five UPs.

Pool1: (UP1 = 4096 + 4096 + 4096 + 4096, UP2 = 4096 + 4096 + 4096, UP3 = 4096 + 4096 + 4096, UP4= 4096 + 4096 + 4096, UP5= 4096 + 4096 + 4096)

In this case, UP override or load imbalance due to chunk imbalance happens after 122880 (six chunks \*4096 size\*5 UPs) addresses is used, and each UP has only 8k addresses per minute from each UP. Since threshold timer is 60 sec and incoming subscriber rate is 6k, UPs can cater to all subscribers.

As evident in this case, chunk size of 4096 results in better IP resource distribution among the UPs than having 8096 chunk size. As the IP resources reach exhaustion, the UP override or load imbalance happens on such UPs. In this example, it starts happening after the usage of around 61440 addresses per pool. Also, because there are two IP pools in the pool group at the same time, chunk replenishment is 4k from pool1 + 4k from pool2, which is greater than the required rate of 6k.

## UP Grouping Guidelines

You must separate the consumer and enterprise customers in different UP groups since the IP pool size and routing requirements for each of them are different. Default UP group is used for the consumer customers. It's recommended to create specific User Groups for the enterprise customers and associate with enterprise APNs. Though the chunking mechanism provides the efficient IP address management for larger pools, it should be avoided in case of smaller pool sizes (for example, IP pool size less than 4k). It's recommended to dedicate the smaller IP pools to a particular UP. You can achieve this by having single UP in specific UP group and associating it to the APN.

Consider a case where you have five UPs and want to serve 40 small enterprise APNs of 256 addresses, and eight large consumer APNs of 64k addresses each. In this case, make two UP-groups, UPGroup1 consisting of one UP and 40 small enterprise APNs, and UPGroup2 consisting of four UPs and eight large consumer APNs.

## UP Addition Guidelines

Before adding a new UP in a UP group, operator should ensure that there are free chunks available for all APNs at CP, which can be allocated during UP registration. This ensures that there are no uneven load distribution, as this UP still gets selected for call distribution even if one APN doesn't have any IP address available for this UP.

## Miscellaneous Guidelines

- Use Pool Usage threshold alarms to get warning about the replenishment of IP pool resources. Take appropriate action, that is, adding a new pool in pool group.
- For IPv4v6 sessions in case of dynamic v4v6 address allocation, both IPv4 and IPv6 addresses that need to be assigned to UE belong to the same UP. IP pool planning must ensure that enough v4 and v6 IP addresses are available at per UP level on which v4v6 calls are expected.

Consider one IPv4 pool with name “poolv4” x.x.x.x/17 of 32k address and IPv6 pool with name “poolv6” x:x:x:x:/48 of 64k address. Consider that there are two APNs, APN1 which wants to make v4v6 call and operates on both “poolv4” and “poolv6”:

**ip pool poolv4 209.165.200.224/17** – 32k address used by APN1

**ipv6 pool poolv6 prefix 2003::/48** - 64k address used by APN2

If APN2 ends up using more than 32k IPv6 address, then there might not be sufficient IPv6 addresses left for v4v6 for APN1 due to poor planning of APNs. Segregate poolv6 of 64k address into poolv6\_1 of 32k address used by APN1 and poolv6\_2 of 32k address used by APN2. If needed, APN2 should add more IPv6 pools if it requires more IP addresses rather than starving APN1 of its fair share.

## Static IP Pool Guidelines

Static IP pool is used in following scenarios:

- UE sends IP Address in Initial Attach.
- AAA/S6b returned IP Address.
- DHCP returned IP Address.

In the case of static IP pool, address is already decided by UE, and the benefit of UP selection goes away. Only the UP that has the chunk, which contains the selected IP address, can serve that call. For static IP pool, chunks are given to UP when UE requests first IP from an unused chunk. These chunks are given to UPs in a UP group in round robin fashion. Static chunks once allocated are never taken back from UP except in the case of Sx restart. The following are the guidelines with respect to static pools:

- For static IP pool, make one call as part of MOP procedure to dedicate that chunk to a particular UP. This helps in avoiding latency on first call, as the chunk is pushed on first call only.
- For static IP pool, use non-default UP group with limited number of UPs serving all the APNs with static IP pool.
- For static IP pool, use uniform chunk size across all pools. Pools should be of uniform size to avoid load imbalance on UPs, as UP selection can't be used with static IP pool as explained before.
- For the static IPv4v6 PDNs to be successful, both IPv4 and IPv6 addresses need to be on the same UP. Only way to ensure this is to have a single UP in the UP group.
- For the multi-PDNs on same APN with one PDN static and other PDN dynamic to be successful, both addresses must be on the same UP. Since for dynamic pool, address is selected by UP selection algorithm, and for static address, UP is decided by the IP selected, the only way to avoid load imbalance is to have single UP in the UP group.

## Implications of Taking Very Big Chunk Size

### Pool System Limits

Currently CP DI-Large model supports the scaling numbers for parameters as listed in the table given below. These limits remain constant irrespective of the chunk size value that is used and represent the maximum

allowed limit for any given parameter. The limits of the parameter which have reached their maximum value restricted the subsequent parameter's upper limit value.



**Note** Small and medium model comparatively has lower limits.

| Parameters             | Limits                                           |
|------------------------|--------------------------------------------------|
| IPv4 pools per context | 2000                                             |
| IPv6 pools per context | 256                                              |
| IP pools per chassis   | 5000 (including both v4 and v6)                  |
| Dynamic pool addresses | 16 Million per context<br>32 Million per chassis |
| Static pool addresses  | 32 Million per context<br>96 Million per chassis |
| Number of VRFs         | 300 per context<br>2048 per chassis              |
| Max IP Pool size       | 512k                                             |
| Max IPv6 Pool size     | 1 Million                                        |

#### Implications of chunk size on UP group:

The pool is the basic unit for chunk allocation and all UPs are allocated chunks from relevant pools. Maximum UPs which can get chunks with chunk size value of 65536 are  $\text{One Million}/65536 = 16$ . Due to which only 16 UPs are supported in each UP group for the chunk size value being 65536.

#### Implications of chunk size on APN:

For a single UP group used in an APN configuration, the limits are the same as the UP group limit values.

For multiple UP groups used in an APN configuration, refer to the *Multiple UP Groups with Group Specific IP Pool* chapter. The maximum UP groups of 16 UPs that are supported are 16 Million addresses per context or One Million address pool allowing a total of 16 UP groups of 16 UP APN.

Due to the exhaustion of all pool configuration in the v6 pool, the rest of the APN operating in the same VPN context uses the same IPv6 pool. The 16 UP groups of 16 UPs are based on the assumption that there are no IPv4 addresses as otherwise the limit is lower than expected. The system supports around 32 Million dynamic addresses, while only two SGI contexts are allowed.