

Cisco MGX 8800 Series Switch Command Reference

Release 1.1.20

Corporate Headquarters

Cisco Systems, Inc.
170 West Tasman Drive
San Jose, CA 95134-1706
USA

<http://www.cisco.com>

Tel: 408 526-4000
800 553-NETS (6387)

Fax: 408 526-4100

Customer Order Number: DOC-786346=
Text Part Number: 78-6346-04

THE SPECIFICATIONS AND INFORMATION REGARDING THE PRODUCTS IN THIS MANUAL ARE SUBJECT TO CHANGE WITHOUT NOTICE. ALL STATEMENTS, INFORMATION, AND RECOMMENDATIONS IN THIS MANUAL ARE BELIEVED TO BE ACCURATE BUT ARE PRESENTED WITHOUT WARRANTY OF ANY KIND, EXPRESS OR IMPLIED. USERS MUST TAKE FULL RESPONSIBILITY FOR THEIR APPLICATION OF ANY PRODUCTS.

THE SOFTWARE LICENSE AND LIMITED WARRANTY FOR THE ACCOMPANYING PRODUCT ARE SET FORTH IN THE INFORMATION PACKET THAT SHIPPED WITH THE PRODUCT AND ARE INCORPORATED HEREIN BY THIS REFERENCE. IF YOU ARE UNABLE TO LOCATE THE SOFTWARE LICENSE OR LIMITED WARRANTY, CONTACT YOUR CISCO REPRESENTATIVE FOR A COPY.

The Cisco implementation of TCP header compression is an adaptation of a program developed by the University of California, Berkeley (UCB) as part of UCB's public domain version of the UNIX operating system. All rights reserved. Copyright © 1981, Regents of the University of California.

NOTWITHSTANDING ANY OTHER WARRANTY HEREIN, ALL DOCUMENT FILES AND SOFTWARE OF THESE SUPPLIERS ARE PROVIDED "AS IS" WITH ALL FAULTS. CISCO AND THE ABOVE-NAMED SUPPLIERS DISCLAIM ALL WARRANTIES, EXPRESSED OR IMPLIED, INCLUDING, WITHOUT LIMITATION, THOSE OF MERCHANTABILITY, FITNESS FOR A PARTICULAR PURPOSE AND NONINFRINGEMENT OR ARISING FROM A COURSE OF DEALING, USAGE, OR TRADE PRACTICE.

IN NO EVENT SHALL CISCO OR ITS SUPPLIERS BE LIABLE FOR ANY INDIRECT, SPECIAL, CONSEQUENTIAL, OR INCIDENTAL DAMAGES, INCLUDING, WITHOUT LIMITATION, LOST PROFITS OR LOSS OR DAMAGE TO DATA ARISING OUT OF THE USE OR INABILITY TO USE THIS MANUAL, EVEN IF CISCO OR ITS SUPPLIERS HAVE BEEN ADVISED OF THE POSSIBILITY OF SUCH DAMAGES.

Access Registrar, AccessPath, Any to Any, AtmDirector, Browse with Me, CCDA, CCDE, CDDP, CCIE, CCNA, CCNP, CCSI, CD-PAC, the Cisco logo, Cisco Certified Internetwork Expert logo, *CiscoLink*, the Cisco Management Connection logo, the Cisco NetWorks logo, the Cisco Powered Network logo, Cisco Systems Capital, the Cisco Systems Capital logo, Cisco Systems Networking Academy, the Cisco Systems Networking Academy logo, the Cisco Technologies logo, ConnectWay, Fast Step, FireRunner, Follow Me Browsing, FormShare, GigaStack, IGX, Intelligence in the Optical Core, Internet Quotient, IP/VC, Kernel Proxy, MGX, MultiPath Data, MultiPath Voice, Natural Network Viewer, NetSonar, Network Registrar, the Networkers logo, *Packet*, PIX, Point and Click Internetworking, Policy Builder, Precept, ScriptShare, Secure Script, ServiceWay, Shop with Me, SlideCast, SMARTnet, SVX, *The Cell*, TrafficDirector, TransPath, ViewRunner, Virtual Loop Carrier System, Virtual Service Node, Virtual Voice Line, VisionWay, VlanDirector, Voice LAN, WaRP, Wavelength Router, Wavelength Router Protocol, WebViewer, Workgroup Director, and Workgroup Stack are trademarks; Changing the Way We Work, Live, Play, and Learn, Empowering the Internet Generation, The Internet Economy, and The New Internet Economy are service marks; and ASIST, BPX, Catalyst, Cisco, Cisco IOS, the Cisco IOS logo, Cisco Systems, the Cisco Systems logo, the Cisco Systems Cisco Press logo, Enterprise/Solver, EtherChannel, EtherSwitch, FastHub, FastLink, FastPAD, FastSwitch, GeoTel, IOS, IP/TV, IPX, LightStream, LightSwitch, MICA, NetRanger, Post-Routing, Pre-Routing, Registrar, StrataView Plus, Stratm, TeleRouter, and VCO are registered trademarks of Cisco Systems, Inc. or its affiliates in the U.S. and certain other countries. All other trademarks mentioned in this document are the property of their respective owners. The use of the word partner does not imply a partnership relationship between Cisco and any of its resellers. (9912R)

Cisco MGX 8800 Series Switch Command Reference, Release 1.1.20

Copyright © 2000, Cisco Systems, Inc.

All rights reserved. Printed in USA.

Feedback on the Cisco MGX 8800 Series Switch Command Reference

Release 1.1.20

78-6346-04

Thank you for taking the time to fill out this response card. Your input is important to us and helps us to provide you with better documentation.

If you have comments about this document, please complete this self-addressed response card and mail it to us.

We also encourage you to make copies of this blank response card to complete and send to us whenever you have comments about this document. You can mail copies of this card to:

Cisco Systems, Inc.
Attn: Central
Documentation Services
170 West Tasman Drive
San Jose, CA 95134-9883

You can also send us your comments by e-mail to bug-doc@cisco.com, or fax your comments to us at (408) 527-8089.

You can also submit comments electronically on the World Wide Web. Click **Feedback** in the toolbar and select **Documentation**. After you complete the form, click **Submit** to send it to Cisco. We appreciate your comments.



Documentation Response Card

Feedback on the Cisco MGX 8800 Series Command Reference, Release 1.1.20
Part Number 78-6346-04 FCS, 12/09/99

Please respond to the following statements by checking a number from 1 to 5:

- 5 Strongly agree
- 4 Somewhat agree
- 3 Neutral
- 2 Somewhat disagree
- 1 Strongly disagree

Overall, I am satisfied with this document.

Strongly agree 5 4 3 2 1 Strongly disagree

This document is accurate and free of errors.

Strongly agree 5 4 3 2 1 Strongly disagree

I can find the information I need in this document.

Strongly agree 5 4 3 2 1 Strongly disagree

This document is complete and offers enough relevant information for me to do my job.

Strongly agree 5 4 3 2 1 Strongly disagree

This document is written at the correct level of complexity for the subject matter.

Strongly agree 5 4 3 2 1 Strongly disagree

This document is useful to me in doing my job.

Strongly agree 5 4 3 2 1 Strongly disagree

Would you like us to contact you? Yes No

Additional Feedback

Mailing Information

Date

Company Name

Contact Name

Mailing Address

City State/Province

Zip/Postal Code Country

Phone () Extension

Fax () E-mail



NO POSTAGE
NECESSARY
IF MAILED
IN THE
UNITED STATES

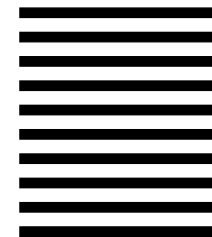

BUSINESS REPLY MAIL
FIRST-CLASS MAIL PERMIT NO. 4631 SAN JOSE CA

POSTAGE WILL BE PAID BY ADDRESSEE

ATTN CENTRAL DOCUMENTATION SERVICES
CISCO SYSTEMS INC
170 WEST TASMAN DRIVE
SAN JOSE CA 95134-9883



About This Manual xv

Objectives	xv
Audience	xv
Cisco WAN Switching Product Name Change	xvi
Organization	xvi
Related Documentation	xvi
Conventions	xvii

MGX 8800 Series Command Line Interface 1-1

?	1-10
abort	1-12
acqdsx3bert	1-14
addapsln	1-15
addaimgrp	1-17
addcdrsoprtn	1-18
addchan	1-21
addchanloop	1-29
addcon	1-31
addendpt	1-42
addimagrp	1-43
addlink	1-44
addlmiloop	1-45
addln	1-47
addlnloop	1-49
addlns2aimgrp	1-51
addport	1-52
addred	1-57
addrscoprtn	1-58
addserialif	1-60
addtrapmgr	1-61
addtrk	1-62
adduser	1-63
agetrapmgr	1-65
aimhelp	1-66
arpAdd	1-69

arpDelete 1-70
arpFlush 1-71
arpShow 1-72
bootChange 1-73
bye 1-75
cc 1-76
cd 1-77
clairmgrpnt 1-78
clairmlncnt 1-79
clrallcnf 1-80
clralm 1-81
clralmct 1-83
clralmctns 1-85
clralms 1-86
clratmlncnt 1-87
clratmlncnts 1-88
clrbertcntrs 1-89
clrcderrs 1-90
clrchanct 1-91
clrchanctns 1-93
clrconct 1-94
clrconctns 1-95
clrerr 1-96
clrifct 1-97
clrifctns 1-98
clrimagrnt 1-99
clrialncnt 1-100
clrlmistats 1-101
clrlog 1-102
clrmsgct 1-103
clrportct 1-104
clrportctns 1-105
clrsarct 1-106
clrsarctns 1-108

clrscrn	1-109
clrslftst	1-110
clsrmcnf	1-111
clsrmcnf	1-112
cmdhistory	1-113
cnfaimgrp	1-114
cnfapsln	1-115
cnfatmln	1-118
cnfbctype	1-119
cnfbert	1-120
cnfcbclk	1-121
cnfcdprtntype	1-124
cnfcdpscprt	1-125
cnfchan	1-127
cnfchaneir	1-130
cnfchancacoff	1-131
cnfchanegressq	1-132
cnfchanfst	1-134
cnfchaningressq	1-137
cnfchanmap	1-139
cnfchanpol	1-141
cnfchanq	1-144
cnfchansrvrate	1-146
cnfclksrc	1-147
cnfcon	1-150
cnfdate	1-154
cnfdsx3bert	1-155
cnfegrservtype	1-157
cnfextclk	1-158
cnfenetgw	1-159
cnffst	1-160
cnfif	1-161
cnfifastrk	1-163
cnfifip	1-164

cnfilmi 1-166
cnfimagr 1-169
cnfln 1-170
cnflnsubrate 1-181
cnfname 1-183
cnfoamlpbk 1-184
cnfpasswd 1-185
cnfplpp 1-186
cnfport 1-188
cnfportcllm 1-191
cnfportq 1-192
cnfportrscprtn 1-193
cnfprfparam 1-195
cnfrscprtn 1-196
cnfserialif 1-198
cnfslftst 1-199
cnfsnmp 1-200
cnfsrcmclksrc 1-201
cnfstatsmgr 1-202
cnfswfunc 1-203
cnftime 1-204
cnftmzn 1-205
cnftmzngmt 1-206
cnftrafficgen 1-207
cnftrapip 1-209
cnftrk 1-210
cnfupcabr 1-213
cnfupccbr 1-217
cnfupcubr 1-220
cnfupcvbr 1-223
cnfvismip 1-228
commit 1-229
copy 1-231
cp 1-232

cth 1-233
copychans 1-234
copyports 1-236
cvsi 1-237
dcct 1-238
dcondb 1-239
del 1-240
delaimgrp 1-241
delapsln 1-242
delbert 1-243
delcdrsoprtn 1-244
delchan 1-245
delchanloop 1-246
delchans 1-248
delcon 1-249
deldsx3bert 1-250
delifip 1-251
dellink 1-252
dellmiloop 1-253
delln 1-255
dellnloop 1-256
dellnsfmaimgrp 1-257
delport 1-258
delports 1-259
delred 1-260
delrsoprtn 1-261
delslotlink 1-262
deltrapmgr 1-263
deltree 1-264
deluser 1-265
dir 1-266
dlmi 1-267
dncon 1-268
dnif 1-269

dnilmi 1-270
downloadflash 1-271
dnport 1-273
dspaimgrp 1-274
dspaimgrcnt 1-276
dspaimgrps 1-277
dspaimlncnt 1-278
dspalm 1-279
dspalmcnf 1-283
dspalmcnt 1-288
dspalms 1-293
dspapscfg 1-295
dspapsln 1-297
dspatmlncnf 1-299
dspatmlncnt 1-300
dspbctype 1-301
dspbert 1-302
dspcbclk 1-303
dspcd 1-304
dspcderrs 1-308
dspcdprtntype 1-309
dspcdrscprtn 1-310
dspcds 1-312
dspchan 1-314
dspchanent 1-320
dspchanmap 1-323
dspchans 1-324
dspchstats 1-326
dspclkinfo 1-328
dspclksrc 1-329
dspcon 1-330
dspconent 1-334
dspcons 1-335
dspcurclk 1-336

dspdsx3bert 1-337
dspegrq 1-338
dspegrqs 1-339
dspegrservtype 1-340
dspenetgw 1-341
dsperr 1-342
dspfeature 1-345
dspfst 1-347
dspfw 1-348
dspfwrevs 1-349
dsphotstandby 1-350
dspif 1-352
dspifcnt 1-353
dspifip 1-354
dspifrsc 1-355
dspifs 1-356
dspilmi 1-357
dspilmicnt 1-359
dspilmis 1-360
dspimagrp 1-361
dspimagrpcent 1-363
dspimagrps 1-364
dspimainfo 1-365
dspimalncnt 1-366
dsplink 1-367
dsplmiloop 1-368
dsplmistats 1-370
dspln 1-371
dsplnrsc 1-374
dsplns 1-375
dsploads 1-378
dsplog 1-379
dsplogs 1-381
dspmaptbl 1-382

dspmsgcnt 1-384
dspname 1-386
dspnwip 1-387
dsपोamlpbk 1-388
dsponoff 1-390
dspparifs 1-391
dspplpp 1-392
dspport 1-393
dspportcnt 1-398
dspportq 1-402
dspportqs 1-404
dspportrscrptn 1-405
dspports 1-406
dspportstats 1-409
dspprf 1-411
dspprfhist 1-418
dspred 1-420
dsprsscrptn 1-421
dsprsscrptns 1-422
dspsarchans 1-423
dspsarcnt 1-425
dspsarcnts 1-429
dspserialif 1-432
dspservrate 1-433
dspshelfalm 1-434
dspslftst 1-436
dspslftsttbl 1-437
dspslotlink 1-438
dspsmcnf 1-439
dspsnmp 1-441
dspsrmclksrc 1-442
dspstatparms 1-443
dspswfunc 1-444
dspsysparm 1-445

dsptotals 1-446
dsptraffigen 1-447
dspttrapip 1-448
dspttrapmgr 1-449
dsprkcnf 1-450
dsprkload 1-451
dsprks 1-452
dspunit391 1-453
dspupgrade 1-454
dspusers 1-455
dspver 1-456
dspvismip 1-457
dth 1-458
dvti 1-459
exit 1-460
formatdisk 1-461
help 1-462
history 1-478
ifShow 1-479
install 1-481
logout 1-484
ls 1-485
memShow 1-486
mkdir 1-487
modbert 1-488
moddsx3bert 1-489
mv 1-491
myid 1-492
newrev 1-493
pagemode 1-495
passwd 1-496
ping 1-497
printrev 1-498
pwd 1-499

remove 1-500
rename 1-501
resetcd 1-502
resetsys 1-503
restoreallcnf 1-504
rnmnd 1-505
routeShow 1-506
routestatShow 1-507
rstupgrade 1-508
runslftstno 1-510
saveallcnf 1-512
sesntimeout 1-513
shutdisk 1-514
softswitch 1-515
startdsx3bert 1-516
switchapsln 1-517
switchback 1-518
switchcc 1-519
syncdisk 1-520
timeout 1-521
tstcon 1-522
tstconseg 1-524
tstdelay 1-526
uncnfifastrk 1-528
upcon 1-529
upif 1-530
upport 1-532
users 1-533
version 1-534
who 1-536
whoami 1-537
xaddcon 1-538
xclrchanct 1-540
xclrportent 1-542

xcnfalm	1-543
xcnfalment	1-545
xcnfbert	1-547
xcnfdsx3bert	1-551
xcnfif	1-554
xcnfifip	1-557
xcnfilmi	1-559
xcnfln	1-562
xcnfport	1-566
xcnfportq	1-569
xcnfred	1-572
xcnfrschrtn	1-574
xcnfsrmlink	1-577
xcnftrapmgr	1-579
xdelcon	1-580
xdnport	1-581
xdspchan	1-582
xdspchancnt	1-587
xdspchans	1-593
xdspcon	1-596
xdspcons	1-598
xdspdsx3bert	1-599
xdspilmi	1-600
xdspln	1-602
xdsplns	1-605
xdsport	1-607
xdsportcnt	1-610
xdsportq	1-614
xdsportqs	1-615
xdsports	1-616
xdspred	1-618
xdspshelf	1-619
xdspsrmlink	1-620
xdsptrapmgr	1-622

xdspusers 1-623

xupport 1-625

Configuration Sequences 2-1

SRM Configurations 2-2

Setting up SRM Line(s) and Link(s) 2-2

Setting 1:N Redundancy 2-2

CESM Configurations 2-3

Setting up CESM Connectivity 2-3

Debugging CESM 2-4

Checking CESM Connectivity 2-4

Running CESM Tests 2-5

Setting Up Local Loopback Testing on a CESM 2-5

Setting Up BERT Session on a CESM 2-5

FRSM Configurations 2-6

Setting Up FRSM Connectivity 2-6

Running FRSM Tests 2-7

Setting Up Local Loopback Testing on a Low-Speed FRSM 2-7

Setting Up Local Loopback Testing on a High-Speed FRSM 2-7

Setting Up T3 BERT Testing on an FRSM 2T3E3 2-8

AUSM Configurations 2-9

Setting Up AUSM Connectivity 2-9

Debugging AUSM 2-10

Checking AUSM Line Connections 2-10

Checking AUSM IMA Group 2-10

Running AUSM Tests 2-11

AUSM Connections 2-11

IMA 2-11

Loopbacks 2-11



About This Manual

Welcome to the command line interface documentation for the Cisco MGX 8800 series wide area edge switch, Release 1.1.20.

This chapter discusses:

- Objectives
- Audience
- Cisco WAN Switching Product Name Change
- Organization
- Related Documentation
- Conventions

Cisco documentation and additional literature are available in a CD-ROM package, which ships with your product. The Documentation CD-ROM, a member of the Cisco Connection Family, is updated monthly. Therefore, it might be more current than printed documentation. To order additional copies of the Documentation CD-ROM, contact your local sales representative or call customer service. The CD-ROM package is available as a single package or as an annual subscription. You can also access Cisco documentation on the World Wide Web at <http://www.cisco.com>, <http://www-china.cisco.com>, or <http://www-europe.cisco.com>.

If you are reading Cisco product documentation on the World Wide Web, you can submit comments electronically. Click **Feedback** in the toolbar, select **Documentation**, and click **Enter the feedback form**. After you complete the form, click **Submit** to send it to Cisco. We appreciate your comments.

Objectives

This publication provides instructions for using the MGX 8800 series commands in the command line interface.

Audience

The Cisco command line interface lets you control the network from a level somewhat below that provided by Cisco WAN Manager (formerly Cisco StrataView Plus). This document helps network designers and operators to set up, manage, and troubleshoot networks.

Cisco WAN Switching Product Name Change

The Cisco WAN Switching products have new names. The BPX switch is now called the Cisco BPX[®] 8620 wide-area switch. The AXIS shelf is now called the Cisco MGX[™] 8220 edge concentrator. Any switch in the IGX switch family (IGX 8, IGX 16 and IGX 32 wide-area switches) is now called the Cisco IGX[™] 8400 series wide area switch. The IGX 8 switch is now called the Cisco IGX[™] 8410 wide area switch. The IGX 16 switch is now called the Cisco IGX[™] 8420 wide-area switch, and the IGX 32 switch is now called the Cisco IGX[™] 8430 wide-area switch. Cisco StrataView Plus is now called the Cisco WAN Manager or CWM.

Organization

The body of this publication is:

- Chapter 1, “MGX 8800 Series Command Line Interface” provides a list of commands for the common equipment cards and the service modules for the Cisco MGX 8800 series wide area edge switch.
- Chapter 2, “Configuration Sequences” provides a list of basic configurations for specific module types.

Related Documentation

The following Cisco publications contain additional information related to the operation of the Cisco WAN switching network:

- Release 9.3 of the Cisco WAN Manager network management system documentation set including:
 - *Cisco WAN Manager Installation and Configuration*; providing a general description and configuration and installation instructions for the Cisco WAN Manager network management system.
 - *Cisco WAN Manager Operations*; providing procedures for using the Cisco WAN Manager network management system.
- The Cisco WAN Switch documentation set including:
 - *Cisco MGX 8850 Installation and Configuration*; providing a general description and configuration and installation instructions for the Cisco MGX 8850 wide area edge switch.
 - *Cisco BPX 8600 Series Installation and Configuration*; providing a general description and configuration and installation instructions for the Cisco BPX 8600 series broadband switches.
 - *Cisco BPX 8600 Series Reference*; providing a general description and technical details of the Cisco BPX 8600 series broadband switches.
 - *Cisco IGX 8400 Series Installation and Configuration*; providing a general description and configuration and installation instructions for the multi-band Cisco IGX 8400 series nodes.
 - *Cisco IGX 8400 Series Reference*; providing a general description and technical details of the multi-band Cisco IGX 8400 series switches.
 - *Cisco WAN Switch Command Reference*; providing detailed information on the command line interfaces used in operating a Cisco WAN switching network.
 - *Cisco WAN Switch Super User Command Reference*; providing detailed information on the superuser command line interface used in operating a Cisco WAN switching network.

Conventions

This publication uses the following conventions to convey instructions and information.

Command descriptions use these conventions:

- Commands and keywords are in **boldface**.
- Arguments for which you supply values are in *italics*.
- Elements in square brackets ([]) are optional.
- Alternative but required keywords are grouped in braces ({ }) and are separated by vertical bars (|).

Examples use these conventions:

- Terminal sessions and information the system displays are in `screen` font.
- Information you enter is in **boldface screen** font.
- Nonprinting characters, such as passwords, are in angle brackets (< >).
- Default responses to system prompts are in square brackets ([]).

Note Means *reader take note*. Notes contain helpful suggestions or references to materials not contained in this manual.



Caution Means *reader be careful*. In this situation, you might do something that could result in equipment damage or loss of data.



Warning This warning symbol means danger. You are in a situation that could cause bodily injury. Before you work on any equipment, you must be aware of the hazards involved with electrical circuitry and familiar with standard practices for preventing accidents. (To see translated versions of this warning, refer to the *Regulatory Compliance and Safety Information* that accompanied your equipment.)

MGX 8800 Series Command Line Interface

The preferred tools for configuring, monitoring, and controlling an MGX 8800 series switch are the CiscoView and Cisco WAN Manager (CWM) applications for equipment management and connection management, respectively. (The Cisco WAN Manager application is the former Cisco StrataView Plus application with the equipment management removed.) The command line interface (CLI) also provides access to an MGX 8800 series switch and is highly applicable during initial installation, troubleshooting, and any situation where low-level control is useful.

The MGX 8800 series commands in the tables that follow are divided by major functional group. Each table shows the complete name of the command and the cards for which the command is valid. For further reference, check the *Installation and Configuration* document for your specific switch type. The *Installation and Configuration* document provides conceptual information about how the Cisco MGX 8800 series switches can best implement network services in your network configuration. Examples of usage for the more common commands appear in the configuration chapters of this manual.

The command line prompt shows the name of the switch, the number of the switch (which is always “1”), the slot number and type for the current card, and whether the card is in the active (“a”) or standby state (“s”). The following is an example of the command line prompt:

```
excel.1.6.AUSM.a >
```

In this case, the current card is an active AUSM in slot 6, and the name of the node is “excel.”

The command notation and argument parameters follow standard programming convention: a space separates the command and each parameter; variables have an italicized typeface; required arguments appear within “<” marks; optional parameters appear within square brackets (“[]”); and a vertical bar (|) represents the logical OR function.

Note You must type all command arguments then press **Return** or **Enter** rather than enter one parameter at a time.

When you enter a command with no parameters, a usage message appears. This message shows syntax and ranges for the applicable command parameters.

The list of commands for the common equipment cards PXM and SRM appear in Table 1-1. These commands are available when you log into the PXM. The Portable AutoRoute (PAR) commands appear in Table 1-1. Applicable service module commands become available when you switch to a card by executing the **cc** command. The list of service module commands appear in Table 1-3. Many commands apply to both the common equipment cards and the service modules.

Table 1-1 PXM Commands

Command	Description
PXM Shelf Group	
addtrapmgr	Add Trap Manager
agetrapmgr	Age Trap Manager
clrcderrs	Clear Card Errors in BRAM
clrmsgcnt	Clear Control Message Counter
cnfclksrc	Configure Network Clock Source
cnfstatsmgr	Configure Statistics Manager
cnftrapmgr	Configure/Add/Delete Trap Managers
deltrapmgr	Delete Trap Manager
dspcd	Display Card
dspcderrs	Display Card Errors in BRAM
dspcds	Display Cards
dspclksrc	Display Clock Sources
dspfwrevs	Display Firmware Revisions
dspmsgcnt	Display Control Message Counter
dspparents	Display SAR Counters
dspsmcnf	Display Service Module Configuration
dspstatparms	Display Statistics Alarms
dspttrapmgr	Display Trap Manager
dspttrapmgrs	Display Trap Managers
resetcd	Reset Card
switchcc	Switch Core Cards
version	Version (displays version data for a card)
xcnftrapmgr	Configure Trap Manager
xdspttrapmgr	Display Trap Manager
PXM User Group	
adduser	Add User
cc	Change Card
clrscrn	Clear Terminal Screen
clrlog	Clear Event/Message Log
cnfpwd	Configure Password
deluser	Delete User
dspllog	Display Event/Message Log
dspusers	Display Users
Help	Help (list of commands per card)
users	Users

Table 1-1 PXM Commands (continued)

Command	Description
PXM Node Group	
cnfname	Configure Shelf Name
cnfdate	Configure Date
cnftime	Configure Time
cnftmzn	Configure Time Zone
cnftmzngmt	Configure Time Zone to GMT
cnfifip	Configure Interface IP Address
delifip	Delete Interface IP Address
dspifip	Display LAN interface IP
PXM Redundancy Group	
addred	Add Redundancy
delred	Delete Redundancy
dspfeature	Display Feature
dspred	Display Redundancy
softswitch	Soft Switch
switchback	Switch Back
PXM Broadband Interface Group	
addrscrptn	Add Resource Partition
clratmlnct	Clear an ATM Line's Counters
clratmlnctns	Clear All ATM Line Counters
clrifcnt	Clear Counters for a Broadband Interface
clrifcnts	Clear All Counters for a Broadband Interface
cnfatmln	Configure ATM Line
cnfcdrsrptn	Configure Card Resource Partition
cnfif	Configure a Broadband Interface
cnfrscrptn	Configure Resource Partition
cnfsvlcn	Configure SVC LCNs
cnfsvcrange	Configure SVC Range
dnif	Disable the Broadband Interface
dspatmlnctf	Display ATM Line Configuration
dspcdrsrprt	Display Card Resource Partition
dspcdrsctype	Display Card Resource Type
dspif	Display Interface
dspifent	Display Interface Count
dspifrsc	Display Interface Resource
dspifs	Display Interfaces
dsplnrsc	Display Line Resource
dsprscrptns	Display All Resource Partitions

Table 1-1 PXM Commands (continued)

Command	Description
dpsvcrange	Display SVC Range
upif	Add a broadband interface on the PXM
PXM Alarm Group	
clralm	Clear Line Alarms
clralment	Clear Alarm Counters/Statistics
dspalm	Display Alarms for a Line
dspalms	Display All Alarms on Card
dspalmcnf	Display Alarm Threshold Configuration
dspalment	Display Alarm Counters/Statistics (line)
dspshelfalm	Display Shelf Alarms
PXM Line Group	
addapsln	Add APS on a Line
addln	Add Line
delln	Delete Line
dspln	Display Line Configuration
dsplns	Display All Lines on Card
dpsrmlns	Display All Lines on Card
PXM Channel Group	
clrsarcnt	Clear SAR Counters
dpsarcnt	Display SAR Counters
dpservrate	Display Service Rate
SRM-3T3 Group	
addlink	Add an SRM-3T3 T3 link to a T1slot and line
clrsrmenf	Clear SRM-3T3 configuration
cnfsrcmclksrc	Configure SRM-3T3 clock source
dellink	Delete an SRM-3T3 T3 link to a T1slot and line
delslotlnk	Delete a link from a T1 slot
dsplink	Display an SRM-3T3 T3 link to a T1slot and line
dpslotlnk	Display a link in a T1 slot
dpsrsmclksrc	Display SRM-3T3 clock source
PXM Self-Test Group	
clrslftst	Clear Self-Test
dpslftsttble	Display Self-Test Table
PXM BERT Group	
cnfbert	Configure BERT session parameters
xcnfbert	
delbert	Stop the current BERT session
dspberr	Display results of BERT session
modbert	Inject bit errors into the current BERT session

Table 1-2 Portable AutoRoute (PAR) Commands

Command	Description
addtrk	Add Trunk
clrerr	Clear Error Log
cnfclksrc	Configure Clock Source
cnfcmparm	Configure Connection Manager Parameters
cnfifastrk	Configure Interface as Trunk
cnfname	Configure Node Name
cnfnwip	Configure Network IP Address
cnfswfunc	Configure Software Function
cnfsysparm	Configure System Parameters
cnftrk	Configure Trunk
deltrk	Delete Trunk
dspcmparm	Display Connection Manager Parameters
dspcon	Display a Connection
dspcons	Display Connections
dsperr	Display Error Log
dspload	Display Load
dspmnp	Display Mandatory Update Parameters
dspname	Display Nodename
dspnw	Display Network
dspnwcons	Display Network Connections
dspnwip	Display Network IP Address
dspswfunc	Display Software Functions
dspsysparm	Display System Parameters
dsptrknf	Display Trunk Configuration
dsptrkcons	Display Trunk Connections
dsptrkload	Display Trunk Load
dsptrkmcons	Display Trunk Management Connections
dsptrks	Display Trunks
uncnfifastrk	Unconfigure Interface Trunk

Table 1-3 Service Module (SM) Commands

Command	Description	FRSM	AUSM	CESM	VISM	CESM-T3E3
SM Shelf Group						
clrcderrs	Clear Card Errors in BRAM	X	X			
clrmsgcnt	Clear Control Message Counter	X	X	X		
clrsmcnf	Clear Service Module Configuration	X	X	X	X	
cnfcdrsprtn	Configure Card Resource Partition	X	X		X	
cnfclksrc	Configure Network Clock Source		X			
cnffst	Configure ForeSight	X	X			
cnfsvcrange	Configure SVC Range	X	X			
dspcd	Display Card	X	X	X	X	X
dspcderrs	Display Card Errors in BRAM	X	X			
dspcdrsprtn	Display Card Resource Partition	X	X			
dspclksrc	Display Clock Sources		X			
dspmsgcnt	Display Control Message Counter	X	X	X	X	X
dspsmcnf	Display Service Module Configuration					X
dspstatparms	Display Statistics Parameters	X				
dsptotals	Display Totals	X				X
resetcd	Reset Card					
version	Version (displays card version data)	X	X	X		X
SM User Group						
cc	Change Card	X	X	X		X
clrscrn	Clear Terminal Screen	X	X	X		X
dspmaptbl	Display Map Table	X	X			X
Help	Help (list of commands per card)	X	X	X	X	X
Alarm Group						
clralm	Clear Line Alarms	X	X	X	X	X
clralmct	Clear Alarm Counters/Statistics	X	X	X	X	X
clralms	Clear All Alarms on the Card	X	X	X	X	X
dspalm	Display Alarms for a Line	X	X	X	X	X
dspalmcnf	Display Alarm Threshold Configuration	X	X	X	X	X
dspalmct	Display Alarm Counters/Statistics (line)	X	X	X	X	X
dspalms	Display All Alarms on Card	X	X	X	X	X
SM Line Group						
addln	Add Line	X	X	X	X	X
addlnloop	Add Line Loop		X	X	X	X
cnfds3ln	Configure DS3 Line	X				
cnfln	Configure Line	X	X	X	X	X
cnfplpp	Configure PLPP Parameters		X			

Table 1-3 Service Module (SM) Commands (continued)

Command	Description	FRSM	AUSM	CESM	VISM	CESM-T3E3
delln	Delete Line	X	X	X	X	X
dellnloop	Delete Line Loop		X	X	X	X
dspds3ln	Display a DS3 Line					
dspds3lns	Display DS3 Lines					
dspln	Display Line Configuration	X	X	X	X	X
dsplns	Display All Lines on Card	X	X	X	X	X
Port Group						
addport	Add Port	X				X
clrportcnt	Clear Port Counters	X	X			
clrportcnts	Clear All Port Counters	X	X			
cnfegrq	Configure Egress Queue	X				
cnfilmi	Configure ILMI		X			
cnfport	Configure FR Port(s)	X	X			
cnfportcllm	Configure Port CLLM Parameters	X				X
cnfportq	Configure AUSM port queue		X			
copyports	Copy Port Configuration	X	X			
delpport	Delete FRSM or AUSM Port	X				
delpports	Delete Port Configurations	X	X			X
dnport	Down Port		X			X
dspegrq	Display Egress Queue					
dspegrqs	Display Egress Queues					
dspilmi	Display ILMI		X			
dspilmicnt	Display ILMI Counters		X			
dspport	Display Port Configuration	X	X			
dspportcnt	Display FR Port Counters	X	X			
dspportq	Display Port Queue		X			
dspportqs	Display Port Queues		X			
dspports	Display All Ports	X	X			
dspportstats	Display Port Statistics	X				
upport	Up Port		X			
SM Channel Group						
addchan	Add Channel	X		X	X	X
addchanloop	Add a Channel Loopback	X	X	X		
clrchanct	Clear Channel Counter for FRSM or AUSM Channels	X	X	X		X
clrsarcnts	Clear SAR Counters	X	X	X		
cnfchancaoff	Configure Channel Admission Control Off	X				
clrchanctns	Clear Channel Counter for all FR Channels	X	X	X		

Table 1-3 Service Module (SM) Commands (continued)

Command	Description	FRSM	AUSM	CESM	VISM	CESM-T3E3
cnfchanegressq	Configure Channel Egress Queue	X				
cnfchanfst	Configure Channel ForeSight	X	X			
cnfchaningressq	Configure Channel Ingress Queue					X
cnfchanmap	Configure Channel Map	X	X	X		
cnfchanpol	Configure Channel Policing	X				
cnfchanq	Configure Channel Queue		X			X
copychans	Copy Channel Configurations	X	X			X
delchan	Delete Channel(s)	X		X	X	X
delchanloop	Delete a Channel Loopback	X	X	X		
delchans	Delete Channels	X	X			X
dspchan	Display Channel Configuration	X		X	X	X
dspchancnt	Display Channel Counters	X	X	X		X
dspchans	Display All Channels	X		X	X	
dspchstats	Display Channel Statistics	X				
dspсарnt	Display SAR Counters	X	X	X	X	
SM Connection Group						
addcon	Add Connection		X		X	
cnfupcabr	Configure UPC for ABR		X			
cnfupcabr	Configure UPC for CBR		X			
cnfupcubr	Configure UPC for UBR		X			
cnfupcvbr	Configure UPC for VBR		X			
delcon	Delete Connection		X		X	
dspcon	Display a Connection		X		X	
dspcons	Display Connections		X		X	
dsploads	Display Loads		X			
tstcon	Test Connection	X	X	X		X
tstconseg	Test Connection Segment		X			
SM Self-Test Group						
clrslftst	Clear Self-Test	X	X	X		X
dspslftsttble	Display Self-Test Table	X	X	X		X
SM BERT Group						
acqdsx3bert	Acquire BERT	X		X		
clrbertcntrs	Remove BERT counters	X		X		
cnfdsx3bert	Configure BERT parameters	X		X		
xcnfdsx3bert						
deldsx3bert	Stop BERT test session	X		X		
dspdsx3bert	Display BERT results	X		X		
xdspdsx3bert						

Table 1-3 Service Module (SM) Commands (continued)

Command	Description	FRSM	AUSM	CESM	VISM	CESM-T3E3
moddsx3bert	Inject bit errors into BERT session	X		X		
startdsx3bert	Begin the BERT session	X		X		
IMA Group						
addimagrp	Set up a new IMA Group		X			
addlns2imagrp	Add lines to IMA Group		X			
clrimagrpcnt	Delete IMA Group counters		X			
clrimalncnt	Delete line counters of IMA Group		X			
clrimatst	Stop IMA Group test		X			
cnfimaalmparm	Configure IMA Group alarm parameters for IMA Group		X			
cnfimagrp	Configure IMA Group		X			
cnfimatst	Configure testing for IMA Group		X			
delimagrp	Remove IMA Group		X			
delnsfmimagrp	Remove lines from IMA Group		X			
dspimaalmparm	Display IMA alarm parameters		X			
dspimagrp	Display IMA Group configuration		X			
dspimagrpcnt	Display current IMA Group counters		X			
dspimagrps	Display all IMA Groups		X			
dspimaln	Display IMA Group line		X			
dspimalncnt	Display lines counters of IMA Group		X			
dspimatst	Display IMA Group test parameters		X			

?

?

Use the ? command to view all commands associated with the current card, and to view a list of commands associated with a truncated command entry.

Full Name

Help

Card(s) on Which This Command Executes

PXM, FRSM, AUSM, CESH

Syntax

? [*command*]

Syntax Description

command Full or partial name of the command.

Related Commands

help

Attributes

Log: No State: Any Privilege: Any User

Examples

This section contains the following examples:

- View all commands associated with a partial command entry string
- View all commands associated with the current card

Example 1-1 View all commands associated with a partial command entry string

```
raviraj.1.7.PXM.a > ? con
```

```
Available commands
```

```
-----
```

```
addcon  
clrconcnt  
clrconcnts  
cnfcon  
dcondb  
delcon  
dspcon  
dspconcnt  
dspcons  
shellConn  
tstcon  
tstconseg
```

```
raviraj.1.7.PXM.a >
```

Example 1-2 View all commands associated with the current card

System response for the ? command is identical to that when executing the **help** command. See the examples in the **help** section beginning on page 1-462.

abort

Use the **abort** command to stop the upgrade process and return to the previous firmware version.

- Using **abort** after a **newrev** returns the PXM to the original firmware image.
- Using **abort** after **install** resets the PXM(s) to their original states.

See Figure 1-1 to see the relationship of the **abort** command compared with other firmware commands.

Figure 1-1 Firmware-related Commands

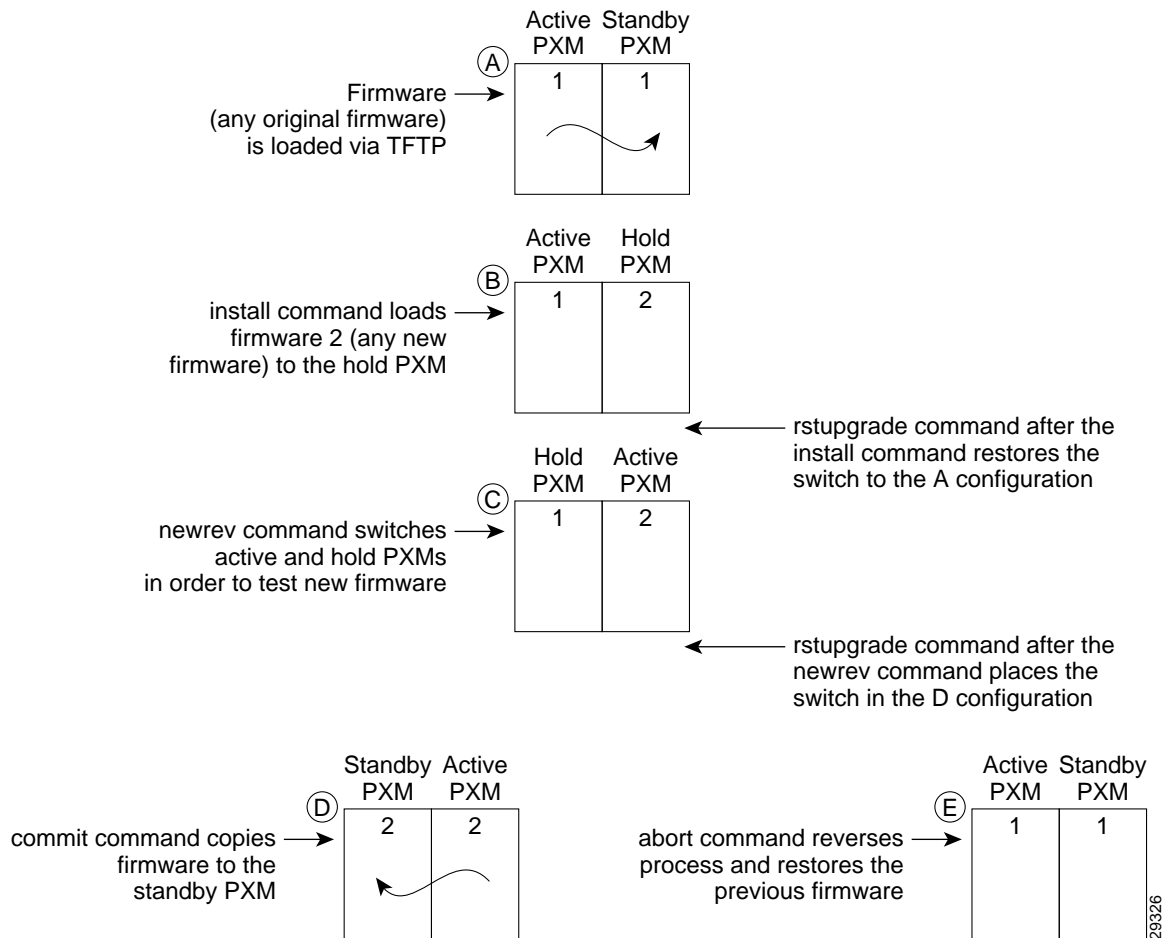

Full Name

Abort

Card(s) on Which This Command Executes

PXM

Syntax

abort <version>

Syntax Description

version Original firmware version.

A system response does not occur unless an error is detected.

Related Commands

dspupgrade, rstupgrade, newrev, dspfwrevs, printrev, commit, copy, install

Attributes

Log: No State: Active Privilege: Any User

Example 1-3 Abort loading firmware 1.1.10

```
NODENAME.1.7.PXM.a > abort 1.1.10
this may take a while ...
abort command completed ok
This card will be reset, the other will become active.
```

Example 1-4 Errors loading firmware (multiple cases)

```
NODENAME.1.8.PXM.a > abort 1.1.11
cannot be in 'upgrade idle', must be in 'upgrade newrev' or 'upgrade
install'
ERR: command "abort" failed

NODENAME.1.7.PXM.a > abort 1.1.11
1.1.11 is not the old version 1.1.10aa
ERR: command "abort" failed
```

acqdsx3bert

Use the **acqdsx3bert** command to find out if a BERT session already exists on the selected MGX 8800 series switch bay.

Full Name

Acquire DS3 BERT

Card(s) on Which This Command Executes

FRSM 2CT3, CESMT3

Syntax

acqdsx3bert

Related Commands

cnfdsx3bert, dspdsx3bert, moddsx3bert, startdsx3bert, xcnfdsx3bert, xdspdsx3bert

Attributes

Log: No State: Active Privilege: Any User

Example 1-5 Acquire the current BERT session

```
NODENAME1.1.21.CESMT3.a > acqdsx3bert
dspdsx3BertCntrs :
BCRunning : 00
BCStorage : 0
BECRunning : 00
BECStorage : 0

DSX3 BERT in Sync

NODENAME1.1.21.CESMT3.a >
```

addapsln

Use the **addapsln** command to set Automatic Protection Switching (APS) on a specified line for the current PXM.

APS is a SONET switching mechanism that routes traffic from working lines to protect them in case of a line card failure or fiber cut.

To set APS parameters, use the **cnfapsln** command following the **addapsln** command.

Full Name

Add APS to a Line

Card(s) on Which This Command Executes

PXM

Syntax

addapsln <workline> <workslot> <protectline> <protectslot> <archmode>

Syntax Description

<i>workline</i>	Slot number of the PXM. Enter the value 7 or 8.
<i>workslot</i>	OC-3 or OC-12 line number on which to set APS. <ul style="list-style-type: none"> • OC-3 range = 1–4 • OC-12 = enter the value 1
<i>protectline</i>	Protection line number. <ul style="list-style-type: none"> • OC-3 range = 1–4 • OC-12 = enter the value 1
<i>protectslot</i>	Protection slot number: Enter the value 7 or 8.
<i>archmode</i>	Value to set APS architect mode to be used on the working/protection line pairs. <ul style="list-style-type: none"> • 1 = 1+1 one backcard • 2 = 1+1 two backcards • 3 = 1:1 one backcard • 4 = 1+1 Annex B

Related Commands

cnfapsln, delapsln, dspapsln, switchapsln

Attributes

Log: Yes State: Active Privilege: SuperUser

Example 1-6 Add APS Protection line 1 on slot 8 to APS Working line1 on slot 7. Set the APS architect mode on the working/protection line pair to 1+1.

```
spirit4.1.8.PXM.a > addapsln 1 7 1 8 2  
spirit4.1.8.PXM.a >
```

addaimgrp

Use the **addaimgrp** command to set an AIMUX group on the current AUSM.

Full Name

Add IMA Group

Card(s) on Which This Command Executes

AUSM

Syntax

addaimgrp <group_num> <port_type> <list_of_links> minNumLinks

Syntax Description

<i>group_num</i>	AIMUX group number, in the range 1–8.
<i>port_type</i>	Value to set UNI or NNI port type. <ul style="list-style-type: none"> • 1 = UNI • 2 = NNI
<i>list_of_links</i>	List of physical lines, in the range 1-8, to be included in “aimux_grp.” Type a period (“dot”) between each line in the string to delineate each member of the AIMUX group.
<i>minNumLinks</i>	Minimum number of links for the group formation, in the range 1–8.

Related Commands

delaimgrp, cnfaimgrps, dspaimgrp, dspaimgrps

Attributes

Log: Yes State: Active Privilege: 1–2

Note There should not be any ATM UNI ports established with the same “port_n” since ATM ports and AIMUX groups both share the same set of port numbers.

Example 1-7 Add IMA group 2 as UNI with lines 3, 4, and 5

```
spirit4.1.18.PXM.a > addaimgrp 2 3.4.5
spirit4.1.18.PXM.a >
```

A system response does not occur unless an error is detected.

addcdrsoprtn

Use the **addcdrsoprtn** command to set card-level resource partitions.

Note This command applies only if the card partition type is *controllerBased*.

The resource you can partition at the card level is the number of connections available to a network controller such as PAR.

With card-level partitioning:

- The number of connections available at each port is the same.
- You can specify the number of connections available to each controller or let them compete for connections at each port.

Table 1-4 describes the effects of each of three usages of **addcdrsoprtn**.

Table 1-4 Degrees of Card-Level Resource Partitioning

Command	Description
addcdrsoprtn off	Card-level partitioning is inactive. You must partition resources at the port level. (See also cnfportsoprtn .)
addcdrsoprtn on	Default. Card-level partitioning is on, but no allocation for a specific controller is specified. The maximum number of connections on a port is available to each controller. Each controller therefore competes for the connections.
addcdrsoprtn on <x> <y> <z>	Same as addcdrsoprtn , except <i>x</i> , <i>y</i> , and <i>z</i> represent the number of connections per port available to the PAR, PNNI, and Tag controllers, respectively. Note that PNNI is always 0 in MGX 8800 Release 1.

In addition to the definitions in Table 1-4, note the following characteristics of this command:

- If you specify that card-level partitioning is off (**addcdrsoprtn off**), port-level partitioning is mandatory (**cnfportsoprtn**).
- If you do not execute **addcdrsoprtn**, the default state of **addcdrsoprtn on** is in effect.
- If you specify card-level partitioning (**addcdrsoprtn on x y z**), port-level partitioning (**cnfportsoprtn**) is an option you can use to further modify the partitioning on a port.

Full Name

Add Card Resource Partition

Card(s) on Which This Command Executes

PXM, FRSM, CESM, VISM

Syntax: PXM**addcdrsoprtn** <ctrlr_num> <num_lcns>**Syntax Description**

<i>ctrlr_num</i>	Value to set controller type. <ul style="list-style-type: none">• 1 = PAR• 2 = PNNI• 3 = TAG
<i>num_lcns</i>	Number of available GLCNs, in the range 0 - 32767.

Syntax: FRSM**addcdrsoprtn** <controller> <numOfLcnAvail>**Syntax Description**

<i>controller</i>	Value to set controller type. <ul style="list-style-type: none">• 1 = PAR/PVC• 2 = PNNI/SPVC• 3 = TAG
<i>numOfLcnAvail</i>	Maximum number of LCNs, in the range appropriate for the card. <ul style="list-style-type: none">• 2CT3 range = 1–4000• 2T3 range = 1–2000• 2E3 range = 1–2000• HS2 range = 1–2000

Syntax: CESM**addcdrsoprtn** <controller> <numOfLcnAvail>**Syntax Description**

<i>controller</i>	Value to set controller type. <ul style="list-style-type: none">• 1 = PAR/PVC• 2 = PNNI/SPVC• 3 = TAG
<i>numOfLcnAvail</i>	Maximum number of LCNs, in the range 0–248.

Related Commands

cnfcdrsoprtn, dspcdrsoprtn, delcdrsoprtn, cnfcdrsctype

Example 1-8 On the current PXM, change the card-level partitioning to give 10000 GLCNs to PAR and 10000 GLCNs to Tag. Note that the value for PNNI currently is 0.

```
spirit4.1.8.PXM.a > addcdrsoprtn 10000 0 10000  
spirit4.1.8.PXM.a >
```

addchan

Use the **addchan** command to configure channels on the current PXM, FRSM, AUSM, or CESM. The syntax for using **addchan** on an AUSM differs from that used on all other cards. See page 1-Syntax: AUSM, page 1-25 for guidelines.

Full Name

Add Channel

Card(s) on Which This Command Executes

PXM, FRSM (8T1/E1, HS1/B, VHS), AUSM, CESM

Related Commands

delchan, **dspchan**, **dspchans**

Attributes

Log: No

State: Any

Privilege: Any

Syntax: PXM

addchan <LCN> <if_num> <conn_type> <vpi> <vci> <serv_type> <y_vpi> <y_vci> <y_nsap>
<chan_master>

Syntax Description

<i>LCN</i>	Logical connection number, in the range 16–4111.
<i>if_num</i>	Number of the logical interface port that receives connection traffic, in the range 1–32.
<i>conn_type</i>	Value to set VPC or VCC connection type. <ul style="list-style-type: none">• 1 = VPC (Virtual Path Connection)• 2 = VCC (Virtual Channel Connection)
<i>vpi</i>	VPI (Virtual Path Identifier) value, in the range 0–4095.
<i>vci</i>	VCI (Virtual Channel Identifier) value, in the range 0–65535.
<i>serv_type</i>	Value to set service type. <ul style="list-style-type: none">• 1 = CBR (Constant Bit Rate)• 2 = VBR (Variable Bit Rate)• 3 = ABR (Available Bit Rate)• 4 = UBR (Unspecified Bit Rate)• 5 = VBR-RT (Variable Bit Rate-Real Time Class)
<i>y_vpi</i>	Remote VPI value, in the range 0–4095.
<i>y_vci</i>	Remote VCI value, in the range 0–65535.
<i>y_nsap</i>	Remote Network Service Access Point (NSAP) value, in the format node.slot.port. An NSAP is the point at which OSI Network Service is made available to a transport layer (Layer 4) entity.
<i>chan_master</i>	Value to set status of local endpoint as master or slave. <ul style="list-style-type: none">• 1 = master• 2 = slave

Syntax: FRSM-8T1/E1

addchan <chan> <port> <dpci> <cir> <chan_type> [CAC] <mastership> <locnsap> <rmtvpi>
<rmtvci> <rmtnsap>

Syntax Description

<i>chan</i>	Channel number, in the range 16–1015.
<i>port</i>	Port number for T1 or E1. <ul style="list-style-type: none"> • T1 range = 1–192 • E1 range = 1–248
<i>dlci</i>	DLCI (data-link connection identifier) value, in the range 0–1023.
<i>cir</i>	CIR (committed information rate) value for T1 bps or E1 bps. <ul style="list-style-type: none"> • T1 range = 0–1536000 • E1 range = 0–204800
<i>chan_type</i>	Value to set channel type. <ul style="list-style-type: none"> • 1 = NIW • 2 = SIW-transparent • 3 = SIW-translation • 4 = FUNI • 5 = frame forwarding
<i>CAC</i>	Value to enable or disable CAC (Connection Admission Control). <ul style="list-style-type: none"> • 1 = enable • 2 = disable (default)
<i>mastership</i>	Value to set status of current end as the master or slave. <ul style="list-style-type: none"> • 1 = master • 2 = slave
<i>locnsap</i>	20-byte string, which is the hexadecimal form of the ASCII character string that identifies the remote node name, slot, and port in NSAP format.
<i>rmtvpi</i>	Remote VPI value, in the range 1–65535.
<i>rmtvci</i>	Remote VCI value, in the range 1–65535.
<i>rmtnsap</i>	20-byte string, which is the hexadecimal form of the ASCII character string that identifies the remote node name, slot, and port in NSAP format.

Syntax: FRSM-HS1/B

addchan <chan_num> <port_num> <dlci_num> <cir> <chan_type> [CAC] <mastership>
<locnsap> <rmtvpi> <rmtvci> <rmtnsap>

Syntax Description

<i>chan_num</i>	Channel number, in the range 16–1015.
<i>port_num</i>	Port number, in the range appropriate for the interface. <ul style="list-style-type: none"> • X.21 range = 1–4 • HSSI range = 1–2
<i>dlci_num</i>	Data-Link Connection Identifier (DLCI) value, in the range 0–1023.
<i>cir</i>	CIR (Committed Information Rate) value, in the range appropriate for the interface. <ul style="list-style-type: none"> • X.21 range = 0–10000000 bps • HSSI range = 0–20000000 bps
<i>chan_type</i>	Value to set channel type. <ul style="list-style-type: none"> • 1 = NIW • 2 = SIW-transparent • 3 = SIW-translation • 4 = FUNI • 5 = frame forwarding
<i>CAC</i>	Value to enable or disable CAC (Connection Admission Control). <ul style="list-style-type: none"> • 1 = enable • 2 = disable (default)
<i>mastership</i>	Value to set current end as master or slave. <ul style="list-style-type: none"> • 1 = master • 2 = slave
<i>locnsap</i>	20-byte string, which is the hexadecimal form of the ASCII character string that identifies the remote node name, slot, and port in NSAP format.
<i>rmtvpi</i>	Remote VPI value, in the range 1–65535.
<i>rmtvci</i>	Remote VCI value, in the range 1–65535.
<i>rmtnsap</i>	20-byte string, which is the hexadecimal form of the ASCII character string that identifies the remote node name, slot, and port in NSAP format.

Syntax: FRSM-VHS

addchan <chan> <port> <dlci> <cir> <chan_type> <serv_type> [CAC_enable] <mastership> <locnsap> <rmtvpi> <rmtvci> <rmtnsap>

Syntax Description

<i>chan</i>	Channel number, in the range 16–4015.
<i>port</i>	Port number, in the range 1–256.
<i>dlci</i>	Data-Link Connection Identifier (DLCI) value, in the range 0–1023.
<i>cir</i>	CIR (Committed Information Rate) value for T1 bps or E1 bps. <ul style="list-style-type: none"> • T1 range = 0–1536000 • E1 range = 0–2048000
<i>chan_type</i>	Value to set channel type. <ul style="list-style-type: none"> • 1 = NIW • 2 = SIW-transparent • 3 = SIW-translation • 4 = FUNI • 5 = frame forwarding
<i>serv_type</i>	Value to set service type. <ul style="list-style-type: none"> • 1 = CBR (Constant Bit Rate) • 2 = VBR (Variable Bit Rate) • 3 = ABR (Available Bit Rate) • 4 = UBR (Unspecified Bit Rate)
<i>CAC_enable</i>	Value to enable or disable CAC (Connection Admission Control). <ul style="list-style-type: none"> • 1 = enable • 2 = disable (default)
<i>mastership</i>	Value to set current end as master or slave. <ul style="list-style-type: none"> • 1 = master • 2 = slave
<i>locnsap</i>	20-byte string, which is the hexadecimal form of the ASCII character string that identifies the remote node name, slot, and port in NSAP format.
<i>rmtvpi</i>	Remote VPI value, in the range 1–65535.
<i>rmtvci</i>	Remote VCI value, in the range 1–65535.
<i>rmtnsap</i>	20-byte string, which is the hexadecimal form of the ASCII character string that identifies the remote node name, slot, and port in NSAP format.

Syntax: AUSM

addchan <channel number> <connection type> <port number> <vpi> <vci> <service type>
<mastership> <locnsap> <rmtvpi> <rmtvci> <rmtnsap>

Syntax Description

<i>channel number</i>	Channel number, in the range 16–1015.
<i>connection type</i>	Value to set connection type as either VPC (Virtual Path Connection) or VCC (Virtual Path Connection). <ul style="list-style-type: none">• 1 = VPC• 2 = VCC
<i>port number</i>	Port number, in the range 1–8.
<i>vpi</i>	Virtual Path Indicator (VPI) value, in the range 0–255.
<i>vci</i>	Virtual Channel Indicator (VCI) value, in the range 0–65535.
<i>service type</i>	Value to set service type. <ul style="list-style-type: none">• 1 = CBR (Constant Bit Rate)• 2 = VBR (Variable Bit Rate)• 3 = ABR (Available Bit Rate)• 4 = UBR (Unspecified Bit Rate)
<i>mastership</i>	Value to set status of current end as master or slave. <ul style="list-style-type: none">• 1 = master• 2 = slave
<i>locnsap</i>	20-byte string, which is the hexadecimal form of the ASCII character string that identifies the remote node name, slot, and port in NSAP format.
<i>rmtypi</i>	Remote VPI value, in the range 1–65535.
<i>rmtvci</i>	Remote VCI value, in the range 1–65535. This setting should be identical to that for the logical port number of the remote end point.
<i>rmtnsap</i>	20-byte string, which is the hexadecimal form of the ASCII character string that identifies the remote node name, slot, and port in NSAP format.

Example 1-9 Add a VCC connection to channel 16 on port 1 with vpi=1, vci=1, ABR service type, and an egress queue number of 1

```
spirit4.1.18.AUSM.a > addchan 16 2 1 1 1 3 1
spirit4.1.18.AUSM.a >
```

Syntax: CESM-8T1E1

addchan <chan_num> <port_num> <sig_type> <partial_fill> <cond_data> <cond_signalling>
 [mastership | locnsap | rmtvpi | rmtvci | rmtnsap]

Syntax Description

<i>chan</i>	Channel number, in the range 32–279.
<i>port</i>	Port number for T1 or E1. <ul style="list-style-type: none"> • T1 range = 1–192 • E1 range = 1–248
<i>sig_type</i>	Value to set type of signaling to be used. All channels on a line should have the same value. <ul style="list-style-type: none"> • 1 = basic • 2 = E1 CAS • 3 = DS1 superframe CAS • 4 = DS1 extended superframe CAS
<i>partial_fill</i>	Number of bytes to partially fill a cell for different lines. <ul style="list-style-type: none"> • 0 = a fully filled cell (default) • 20–47 = cells for structured E1 • 25–47 = for structured T1 • 33–47 = for unstructured T1 or E1
<i>cond_data</i>	Value to set data-conditioning for either UDT or SDT. <ul style="list-style-type: none"> • UDT = 255 • SDT range = 0–255
<i>cond_sig</i>	Condition signal, in the range 0–15.
<i>mastership</i>	Value to set status of current end as master or slave. <ul style="list-style-type: none"> • 1 = master • 2 = slave (default)
<i>locnsap</i>	20-byte string, which is the hexadecimal form of the ASCII character string that identifies the remote node name, slot, and port in NSAP format.
<i>rmtvpi</i>	Remote VPI value, in the range 1–65535.
<i>rmtvci</i>	Remote VCI value, in the range 1–65535. This setting should be identical to that for the logical port number of the remote end point.
<i>rmtnsap</i>	20-byte string, which is the hexadecimal form of the ASCII character string that identifies the remote node name, slot, and port in NSAP format.

Syntax: CESM-T3E3

addchan <chan_num> <port_num> <cond_sig> <mastership> <locnsap> <rmtvpi> <rmtvci> <rmtnsap>

Syntax Description

<i>chan</i>	Channel number. Enter the value 32.
<i>port</i>	Port number. Enter the value 1.
<i>cond_sig</i>	Condition signal number, in the range 0–15.
<i>mastership</i>	Value to set status of the current end as master or slave. <ul style="list-style-type: none">• 1 = master• 2 = slave
<i>locnsap</i>	20-byte string, which is the hexadecimal form of the ASCII character string that identifies the remote node name, slot, and port in NSAP format.
<i>rmtvpi</i>	Remote VPI value, in the range 1–65535.
<i>rmtvci</i>	Remote VCI value, in the range 1–65535. This setting should be identical to that for the logical port number of the remote end point.
<i>rmtnsap</i>	20-byte string, which is the hexadecimal form of the ASCII character string that identifies the remote node name, slot, and port in NSAP format.

Attributes

Log: Yes State: Active Privilege: 1–2

addchanloop

Use the **addchanloop** command to configure a channel loopback to the current FRSM or AUSM card. This command causes the channel to loop at the Segmentation and Reassembly (SAR) stage.

Full Name

Add a Channel Loopback

Card(s) on Which This Command Executes

FRSM, AUSM

Syntax: FRSM

addchanloop <*chan_num*>

Syntax Description

chan_num Channel number to be used for the loopback on the current card.

- FRSM
 - 8T1/E1 range = 16–1015
 - HS1/B range = 16–1015
 - T3/E3/HS2 range = 16–2015
 - 2CT3 range = 16–4015

Syntax for AUSM-8T1E1

addchanloop <*port.VPI.VCI* | *ChanNum*>

Syntax Description

port.VPI.VCI Port range = 1–n, as appropriate for the physical installation.

VPI range = 1–4095.

VCI range = 1–65535.

ChanNum Channel number, in the range 16–1015.

Related Commands

delchanloop, **tstcon**, **tstdelay**

Attributes

Log: Yes

State: Active

Privilege: 1–4

Example 1-10 Adding channel loopback onto channel number 21

```
s1.1.12.AUSMB8.a > addchanloop 21
```

Example 1-11 Adding channel loopback onto port 2, VPI 1, VCI 1

```
s1.1.12.AUSMB8.a > addchanloop 2.1.1
```

addcon

Use the **addcon** command to configure connectivity to the current card. The **addcon** command is preferable to **addchan** for adding a connection because **addcon** does not require the NSAP addresses.

Command execution includes a specification of the endpoint as either the master or the slave. Execute **addcon** first at the slave end, then the master end. Note the syntax for the master end includes a parameter *SlaveConID*. Rather than a single number, *SlaveConID* is the node name, slot number, port number, and connection identifier (if applicable) of the slave end.

Note To set up a three-segment connection across a network, specify the PXM as slot 0.

Full Name

Add Connection

Card(s) on Which This Command Executes

PXM, FRSM, CESM, AUSM

Related Commands

delcon, **dspcons**, **dspon**

Attributes

Log: Yes

State: Active

Privilege: Any

Syntax: PXM

addcon <port_no> <conn_type> <local_VPI> <local_VCI> <service> [CAC] [mastership]
[remoteConnId]

Syntax Description

<i>port_no</i>	Port number, in the range 1–32.
<i>conn_type</i>	Value to set connection type. <ul style="list-style-type: none">• 1 = VPC• 2 = VCC
<i>local_VPI</i>	Local virtual path identifier, in the range 0–4095.
<i>local_VCI</i>	Local virtual channel identifier, in the range 0–65535.
<i>service</i>	Value to set type of service. <ul style="list-style-type: none">• 1 = CBR• 2 = VBR• 3 = ABR• 4 = UBR
<i>CAC</i>	Enable or disable connection admission control. <ul style="list-style-type: none">• 1 = enable• 2 = disable (default)
<i>mastership</i>	Value to set master or slave. <ul style="list-style-type: none">• 1 = master You must also set <i>remoteConnId</i> for the master.• 2 = slave (default)
<i>remoteConnId</i>	Remote connection identifier, in the format <i>NodeName.SlotNo.PortNo.VPI.VCI</i> .

Syntax: FRSM-8T1/8E1

addcon <port number> <DLCI> <CIR> <channel type> [*Adm_cntrl*] <controller_type>
<mastership> <RemoteEndConID>

Syntax Description

<i>port number</i>	Port number for T1 or E1 <ul style="list-style-type: none">• T1 range = 1–192• E1 range = 1–248
<i>DLCI</i>	DLCI (Data-Link Connection Identifier) value in the range 0–1023.
<i>CIR</i>	CIR (Committed Information Rate) value for T1 bps or E1 bps. <ul style="list-style-type: none">• T1 range = 0–1536000• E1 range = 0–2048000

<i>channel type</i>	Value to set type of connection to be used on the channel. <ul style="list-style-type: none">• 1 = NIW (network interworking)• 2 = SIW-transparent (service interworking without any SDU translation)• 3 = SIW-translation (service interworking with SDU translation)• 4 = FUNI (Frame Relay UNI)• 5 = frame forwarding
<i>Adm_cntrl</i>	Value to enable or disable Connection Admission Control (CAC). <ul style="list-style-type: none">• 1 = enable CAC• 2 = disable CAC (default)
<i>controller_type</i>	Value to set signaling controller type as either PVC or SPVC. <ul style="list-style-type: none">• 1 = PVC (PAR) (default)• 2 = SPVC (PNNI)
<i>mastership</i>	Value to set status of the connection as master or the slave. <ul style="list-style-type: none">• 1 = master• 2 = slave (default)
<i>RemoteEndConID</i>	Node name, slot number, port number, and DLCI. or Node name, slot number, port number, Controller ID, and DLCI for a Frame Relay endpoint. Use one of the following values to set controller type: <ul style="list-style-type: none">• 1 = PAR• 2 = PNNI• 3 = TAG or Node name, slot number, port number, and VPI.VCI for an ATM endpoint.

Syntax: FRSM-2CT3

addcon <port number> <DLCI> <CIR> <channel type> <egress service type> [Adm_cntrl]
<controller_type> <mastership> <RemoteEndConID>

Syntax Description

<i>port number</i>	Port number in the range 1–256.
<i>DLCI</i>	Data-Link Connection Identifier (DLCI) value, in the range 0–1023.
<i>CIR</i>	Committed Information Rate (CIR) bps value, in the range 0–1536000.
<i>channel type</i>	Value to set type of connection on this channel. <ul style="list-style-type: none"> • 1 = NIW (network interworking) • 2 = SIW-transparent (service interworking without any SDU translation) • 3 = SIW-translation (service interworking with SDU translation) • 4 = FUNI (Frame Relay UNI) • 5 = frame forwarding
<i>egress service type</i>	Value to set type of egress service provided on this channel. <ul style="list-style-type: none"> • 1 = highpriorityQ (typically committed bit rate connections) • 2 = rtVBRQ (real-time variable bit rate connections) • 3 = nrtVBRQ (non real-time variable bit rate connections) • 4 = aBRQ (available bit rate connections) • 5 = uBRQ (unspecified bit rate connections)
<i>Adm_cntrl</i>	Value to enable or disable Connection Admission Control (CAC). <ul style="list-style-type: none"> • 1 = enable CAC • 2 = disable CAC (default)
<i>controller_type</i>	Value to set signaling controller type as either PVC or SPVC. <ul style="list-style-type: none"> • 1 = PVC (PAR) (default) • 2 = SPVC (PNNI)
<i>mastership</i>	Value to set status of connection as master or the slave. <ul style="list-style-type: none"> • 1 = master • 2 = slave (default)
<i>RemoteEndConID</i>	Node name, slot number, port number, and DLCI. or Node name, slot number, port number, Controller ID, and DLCI for a Frame Relay endpoint. Use one of the following values to set controller type: <ul style="list-style-type: none"> • 1 = PAR • 2 = PNNI • 3 = TAG or Node name, slot number, port number, and VPI.VCI for an ATM endpoint.

Syntax: FRSM-2T3/2E3

addcon *<port number>* *<DLCI>* *<CIR>* *<channel type>* *<egress service type>* [*Adm_cntrl*]
<controller_type> *<mastership>* *<RemoteEndConID>*

Syntax Description

<i>port number</i>	Port number in the range 1–2.
<i>DLCI</i>	DLCI value in the range 0–1023.
<i>CIR</i>	CIR bps value for 2T3 or 2E3. <ul style="list-style-type: none"> • 2T3 range = 0–44210000 • 2E3 range = 0–34010000
<i>channel type</i>	Value to set type of connection on this channel. <ul style="list-style-type: none"> • 1 = NIW (network interworking) • 2 = SIW-transparent (service interworking without any SDU translation) • 3 = SIW-translation (service interworking with SDU translation) • 4 = FUNI (Frame Relay UNI) • 5 = frame forwarding
<i>egress service type</i>	Value to set type of egress service provided on this channel. <ul style="list-style-type: none"> • 1 = highpriorityQ (typically committed bit rate connections) • 2 = rtVBRQ (real-time variable bit rate connections) • 3 = nrtVBRQ (non real-time variable bit rate connections) • 4 = aBRQ (available bit rate connections) • 5 = uBRQ (unspecified bit rate connections)
<i>Adm_cntrl</i>	Value to enable or disable CAC. <ul style="list-style-type: none"> • 1 = enable CAC • 2 = disable CAC (default)
<i>controller_type</i>	Value to set signaling controller type as either PVC or SPVC. <ul style="list-style-type: none"> • 1 = PVC (PAR) (default) • 2 = SPVC (PNNI)
<i>mastership</i>	Value to set status of connection as master or the slave. <ul style="list-style-type: none"> • 1 = master • 2 = slave (default)
<i>RemoteEndConID</i>	Node name, slot number, port number, and DLCI. or Node name, slot number, port number, Controller ID, and DLCI for a Frame Relay endpoint. Use one of the following values to set controller type: <ul style="list-style-type: none"> • 0 = PAR • 1 = PNNI • 2 = TAG or Node name, slot number, port number, and VPI.VCI for an ATM endpoint.

Syntax: FRSM-HS2

addcon <port number> <DLCI> <CIR> <channel type> <egress service type> [Adm_cntrl] <controller_type> <mastership> <RemoteEndConID>

Syntax Description

<i>port number</i>	Port number, in the range 1–2.
<i>DLCI</i>	DLCI value, in the range 0–1023.
<i>CIR</i>	CIR bps value, in the range 0–51840000.
<i>channel type</i>	Value to set type of connection on this channel. <ul style="list-style-type: none"> • 1 = NIW (network interworking) • 2 = SIW-transparent (service interworking without any SDU translation) • 3 = SIW-translation (service interworking with SDU translation) • 4 = FUNI (Frame Relay UNI) • 5 = frame forwarding
<i>egress service type</i>	Value to set type of egress service provided on this channel. <ul style="list-style-type: none"> • 1 = highpriorityQ (typically committed bit rate connections) • 2 = rtVBRQ (real-time variable bit rate connections) • 3 = nrtVBRQ (non real-time variable bit rate connections) • 4 = aBRQ (available bit rate connections) • 5 = uBRQ (unspecified bit rate connections)
<i>Adm_cntrl</i>	Value to enable or disable CAC. <ul style="list-style-type: none"> • 1 = enable CAC • 2 = disable CAC (default)
<i>controller_type</i>	Value to set signaling controller type as either PVC or SPVC. <ul style="list-style-type: none"> • 1 = PVC (PAR) (default) • 2 = SPVC (PNNI)
<i>mastership</i>	Value to set status of the connection as master or the slave. <ul style="list-style-type: none"> 1 = master 2 = slave (default)

RemoteEndConID Node name, slot number, port number, and DLCI.

or

Node name, slot number, port number, Controller ID, and DLCI for a Frame Relay endpoint. Use one of the following values to set controller type:

- 0 = PAR
- 1 = PNNI
- 2 = TAG

or

Node name, slot number, port number, and VPI.VCI for an ATM endpoint.

Syntax: AUSM

addcon slave | master <port number> <vpi> <vci> <Conn type> <Service Type> [PAR | PNNI]

Syntax Description

slave master	Associates the AUSM port with either master or slave status.
port number	Port number, in the range 1–8.
vpi	Virtual Path Identifier (VPI) value, in the range 0–255.
vci	Virtual Channel Identifier (VCI) value, in the range 0–65535.
Conn type	Value to set type of connection. <ul style="list-style-type: none"> • 0 = VCC connection • non-zero = Local connection VP ID of the VPC (1 to 20 (UNI)/100 (STI)/340 (NNI))
Service Type	Value to set service type. <ul style="list-style-type: none"> • 1 = CBR • 2 = VBR • 3 = ABR
SlaveConID	Used only for master configuration: Node name, slot number, port number, VCI, and VPI of the slave end.
PAR PNNI	(optional) Controller specification, either Portable Auto Route (PAR) or Private Network-to-Network Interface (PNNI).

Example 1-12 Add a VCC connection to channel 16 on port 2 with vpi=1, vci=1, ABR service type, and an egress queue number of 1

```
spirit4.1.18.AUSM.a > addcon 16 2 1 1 1 3 1
spirit4.1.18.AUSM.a >
```

A system response does not occur unless an error is detected.

Syntax: CESM 8T1/E1

addcon <port number> <signalling type> <partial_fill> <cond_data> <cond_signalling> <controller_type> <mastership> <RemoteEndConID>]

Syntax Description

port number	Port number for T1 or E1 interface. <ul style="list-style-type: none"> • T1 range = 1–192 • E1 range = 1–248
-------------	--

<i>signalling type</i>	<p>Channel Associated Signaling (CAS) value.</p> <ul style="list-style-type: none"> • 1 = basic • 2 = E1 CAS • 3 = DS1 superframe CAS • 4 = DS1 extended superframe CAS
<i>partial_fill</i>	<p>Number of bytes to set cell fills, as associated with line types.</p> <ul style="list-style-type: none"> • Partial fill, in the range 0–47. Enter the value either 0 or 47 to set this parameter for fully filled cells. • Structured T1, in the range 25–47. • Structure E1, in the range 20–47. • Unstructured T1/E1, in the range 33–47.
<i>cond_data</i>	<p>Conditional data UDT or SDT.</p> <ul style="list-style-type: none"> • UDT = 255 • SDT range = 0–255 <p>Conditional data is sent on the line when there is an underflow and also toward the network when forming dummy cells.</p>
<i>cond_signalling</i>	<p>Conditional signaling, in the range 0–15.</p> <p>Conditional signaling is sent on the line when there is an underflow and also toward the network when forming dummy cells.</p>
<i>controller_type</i>	<p>Value to set signaling controller type as either PVC or SPVC.</p> <ul style="list-style-type: none"> • 1 = PVC (PAR) (default) • 2 = SPVC (PNNI)
<i>mastership</i>	<p>Value to set status of current end as the master or slave.</p> <ul style="list-style-type: none"> • 1 = master • 2 = slave (default)
<i>RemoteEndConID</i>	<p>Node name, slot number, port number, and DLCI.</p> <p>or</p> <p>Node name, slot number, port number, Controller ID, and DLCI for a Frame Relay endpoint. Use one of the following values to set controller type:</p> <ul style="list-style-type: none"> • 0 = PAR • 1 = PNNI • 2 = TAG <p>or</p> <p>The node name, slot number, port number, and VPI.VCI for an ATM endpoint.</p> <p>Note: the slot number should be set to 0 (zero) to point to the active PXM.</p>

addendpt

Use the **addendpt** command to set the endpoints on the VISM card. An endpoint is a logical port that consists of one or more DS0s. It resembles the logical port on the channelized FRSM or CESM card. The *ds1_num* and the *ds0_list* are used to create the *endpoint ID*. The SU requires the endpoint ID to send the Create Connection (CRCX) command of the SGCP protocol to the VISM.

Full Name

Add End Point

Card(s) on Which This Command Executes

VISM

Syntax

```
addendpt <endpoint_num> <ds1_num> <ds0_list>
```

Syntax Description

<i>endpoint_num</i>	Number of the endpoint, in the range 1–240.
<i>ds1_num</i>	Number of the physical line associated with this endpoint, in the range 1–8.
<i>ds0_list</i>	The list of DS0s at this endpoint. Set the list number as appropriate for T1, E1, or VISM. <ul style="list-style-type: none">• E1 range = 1– 31• T1 range = 1–24• VISM: DS0s can be non-contiguous

You must separate individual DS0s by a period (“.”). For the current release of the VISM, only 1 DS0 can exist on an endpoint. For multiple DS0s, you can specify a range of DS0s with a dash (“-”). For example, 1.3–5 means DS0s 1, 3, 4, and 5.

Related Commands

None

Attributes

Log: Yes State: Active Privilege: Any

Example 1-13 Add endpoint number 1 to physical line 1. This endpoint uses DS0 1

```
spirit4.1.28.VISM.a > addendpt 1 1 1  
spirit4.1.28.VISM.a >
```

A system response does not occur unless an error is detected.

addimagrp

Use the **addimagrp** command to configure an IMA group for the current AUSM.

Full Name

Add IMA Group

Card(s) on Which This Command Executes

AUSM

Syntax

addimagrp <group_num> <port_type> <list_of_links>

Syntax Description

<i>group_num</i>	Number of the IMA group to be configured, in the range 1–8.
<i>port_type</i>	Value to set port type as either UNI or NNI. <ul style="list-style-type: none">• 1 = UNI• 2 = NNI
<i>list_of_links</i>	List of links to be included in group_num. Delineate each item in the list with a dot.

Related Commands

dspimagrp, dspimagrpent, dspimagrps, dspimainfo, dspimalncnt

Attributes

Log: Yes State: Active Privilege: 1–2

Example 1-14 Add IMA group 2 as UNI with lines 3, 4, and 5

```
spirit4.1.88.AUSM.a > addimagrp 2 1 3.4.5
spirit4.1.88.AUSM.a >
```

addlink

Use the **addlink** command to configure a link between a T1 line within a T3 line on a SRM-3T3 card and a slot and line number on a T1 service module.

Full Name

Add Link

Card(s) on Which This Command Executes

PXM

Syntax

addlink <T3 LineNum> <T1Slot> <Number of T1s> <TargetSlotNum> <TargetSlotLineNum>
<T3LineNum>

Syntax Description

<i>T3 LineNum</i>	Line number in the format <i>slot.line</i> . <ul style="list-style-type: none">slot = enter the value 15 or 31port range = 1–3 Slot number 15 is used for the cards in slot 15 and 16 (whichever is active) and slot 31 is used for cards in 31 and 32.
<i>T1Slot</i>	T1 slot number, in the range 1–28.
<i>Number of T1s</i>	Number of T1s, in the range 1–8.
<i>Target Slot number</i>	T1 service module slot number to be linked to the T1 line, in the ranges 1–6, or 11–14, or 17–22, or 27–30.
<i>TargetSlotLineNum</i>	T1 line number in the slot to be linked, in the range 1–4 or 1–8.
<i>T3LineNum</i>	T3 line number, in the range 1–8.

Related Commands

dslink, dellink

Attributes

Log: No State: Active Privilege: Any

Example 1-15 Add a link between the T1 line 1 within T3 line 2 on the SRM-3T3 card in slot 15 and T1 line number 5 on the T1 service module in slot 3

```
spirit4.1.1.8.PXM.a > addlink 15.2 1 3 5
spirit4.1.1.8.PXM.a >
```

addlmiloop

Use the **addlmiloop** command to stop sending LMI connection status messages to the BPX feeder trunk. This command should be used in conjunction with **addfdrp** on the BPX. This command can be used only if a feeder trunk exists.

After you have executed the **addlmiloop** command on the MGX 8800 series switch and the **addfdrp** command on the BPX series switch, use the **dsplmistats** command on the BPX switch. The **dsplmistats** command shows the LMI messages exchanged between the BPX series switch and the MGX 8800 series switch. The LMI messages will not show an increase after LMI looping is implemented.

Figure 1-2 Status Messages Halted between a MGX 8800 Series Switch and a BPX Switch

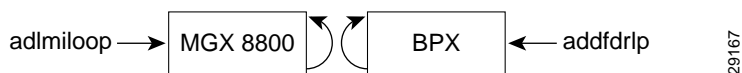

Full Name

Add Line

Card(s) on Which This Command Executes

PXM

Syntax

addlmiloop <slot> <port>

Syntax Description

slot Slot number, in the range 1–32

port Port number, in the range 1–256

Related Commands

dellmiloop, dsplmiloop

Attributes

Log: No State: Active Privilege: 1

Example 1-16 Add an LMI loopback line numbered 1 to the current card (the PXM in slot 8)

```
spirit4.1.8.PXM.a > addlmiloop 1
spirit4.1.8.PXM.a >
```

Example 1-17 Add a feeder loop on the BPX

```
addfdrip 5.5
```

Example 1-18 Display LMI loop

```
spirit4.1.8.PXM.a > dsplmiloop
TRK      IN LMI LOOP
-----
1.8 Yes
```

Example 1-19 Display LMI statistics for the BPX; number of LMI messages in the statistics doesn't increase

VPI.VCI:	3.31		Lmi enabled	Lmi polling enabled
Invalid Pdu	Rx:	0	Status Polling Timer (T396)	: 10
Invalid Pdu Len	Rx:	14	Status Enquiry Timer (T393)	: 10
Unknown Pdu Type	Rx:	0	Max Status Enquiry Retry (N394):	5
Unknown IE Type	Rx:	4	Update Status Timer (T394)	: 10
Bad Transaction	Rx:	0	Max Update Status Retry (N395) :	5
Status	Rx:	46504	Spc Polling Timer	: 2
Status Enq	Tx:	46546	Spc Retry Timer	: 0
Status Enq	Rx:	92014	Spc Retry Counter	: 1
Status	Tx:	92014	Node Status Retry Timer	: 0
Status Ack	Rx:	185	Node Status Retry Counter	: 0
Update Status	Tx:	297	Node Status Polling Timer	: 8
Update Status	Rx:	203		
Status Ack	Tx:	203		

VPI.VCI:	3.31		Lmi enabled	Lmi polling enabled
Invalid Pdu	Rx:	0	Status Polling Timer (T396)	: 10
Invalid Pdu Len	Rx:	14	Status Enquiry Timer (T393)	: 10
Unknown Pdu Type	Rx:	0	Max Status Enquiry Retry (N394):	5
Unknown IE Type	Rx:	4	Update Status Timer (T394)	: 10
Bad Transaction	Rx:	0	Max Update Status Retry (N395) :	5
Status	Rx:	46511	Spc Polling Timer	: 0
Status Enq	Tx:	46553	Spc Retry Timer	: 0
Status Enq	Rx:	92028	Spc Retry Counter	: 1
Status	Tx:	92028	Node Status Retry Timer	: 0
Status Ack	Rx:	185	Node Status Retry Counter	: 0
Update Status	Tx:	297	Node Status Polling Timer	: 9
Update Status	Rx:	203		
Status Ack	Tx:	203		

addln

Use the **addln** command to activate an OC-12, OC-3, T3, or E3 line on the current card.

Full Name

Add Line

Card(s) on Which This Command Executes

PXM, FRSM-series, AUSM, SRM-3T3, CESM-series, VISM

Syntax: PXM

addln -ds3 <line number> | -e3 <line number> | -sonet <line number>

Syntax Description

-ds3	Command delineator that precedes the T3 <i>line number</i> entry.
<i>line number</i>	DS3 line number in the format <i>slot.port</i> . <ul style="list-style-type: none">slot = enter a value from the range 7, 8, 15, 16, 31, or 32port = value in the range 1–<i>n</i>, as appropriate for the physical installation
-e3	Command delineator that precedes the E3 <i>line number</i> entry.
<i>line number</i>	E3 line number format <i>slot.port</i> . <ul style="list-style-type: none">slot = enter a value from the range 7, 8, 15, 16, 31, or 32port = value in the range 1–<i>n</i>, as appropriate for the physical installation
-sonet	Command delineator that precedes the SONET <i>line number</i> entry.
<i>line number</i>	OC-3 or OC-12 line number in the format <i>slot.port</i> . <ul style="list-style-type: none">slot = enter a value of 7. Enter 8 if the active PXM is in slot 8port = value in the range 1–<i>n</i>, as appropriate for the physical installationSet line number value at 7 if the line type is SONET

Note You can activate only one PXM line on the feeder implementation of an MGX 8800 series switch node. With an OC-12 trunk, the only active port with any MGX 8800 series switch implementation is Port 1.

Syntax: FRSM (8T1, 2CT3, HS1/B), AUSM, SRM, CESM, VISM

addln <line_num>

Syntax Description

line_num Line number, in the range appropriate for the interface.

- 8T1 range = 1–2
- CT3 range = 1–2
- HS1/B range = 1–4

Syntax: AUSM (8T1/E1, IMATM-T3T1/E3E1), SRM, CESM, VISM

addln <*line_num*>

Syntax Description

line_num Line number, in the range 1–8.

Related Commands

cnfln, delln, dspln

Attributes

Log: Yes State: Active Privilege: 1 (Any on PXM)

Example 1-20 Add a line numbered 1 to the current card (the PXM in slot 8)

```
spirit4.1.8.PXM.a > addln 1  
spirit4.1.8.PXM.a >
```

addInloop

Use the **addInloop** command to set a specified line in loopback state on the current card.

Full Name

Add Line Loop

Card(s) on Which This Command Executes

PXM, FRSM, AUSM, CESH

Related Commands

dellnloop

Attributes

Log: Yes

State: Active

Privilege: Service (Any on PXM)

Syntax: PXM

addInloop <-ds3 | -e3 | -sonet> <line number>

Syntax Description

- | | |
|--------------------|--|
| -ds3 | Command delineator that precedes the T3 <i>line number</i> entry. |
| <i>line number</i> | DS3 line number in the format slot.port. <ul style="list-style-type: none">• slot = enter a value from the range 7, 8, 15, 16, 31, or 32• port = value in the range 1–n, as appropriate for the physical installation |
| -e3 | Command delineator that precedes the E3 <i>line number</i> entry. |
| <i>line number</i> | E3 line number format slot.port. <ul style="list-style-type: none">• slot = enter a value from the range 7, 8, 15, 16, 31, or 32• port = value in the range 1–n, as appropriate for the physical installation |
| -sonet | Command delineator that precedes the SONET <i>line number</i> entry. |
| <i>line number</i> | OC-3 or OC-12 line number in the format slot.port. <ul style="list-style-type: none">• slot = enter the value either 7 or 8• port = value in the range 1–n, as appropriate for the physical installation• Set line number value at 7 if the line type is SONET |

Syntax: FRSM, AUSM, CESM

addInloop <*line_num*>

Syntax Description

line_num Line number to be set in loopback state, in the range appropriate for the card.

- FRSM
 - 8T1 range = 1–8
 - HS1/B range = 1–4
- AUSM
 - 8T1/8E1 range = 1–8
 - IMATM-T3T1/E3E1 range = 1–8
- CESM, enter a value in the range 1–8

addlns2aimgrp

Use the **addlns2aimgrp** command to add lines to an existing AIMUX group.

Full Name

Add Lines to an AIM Group

Card(s) on Which This Command Executes

AUSM

Syntax

addlns2aimgrp <grp_num> <list_of_lines>

Syntax Description

<i>grp_num</i>	Number of the AIMUX group on which lines are to be added, in the range 1–8.
<i>list_of_lines</i>	List of lines to be associated with this AIMUX group. Use dotted format to delineate each line in your entry string.

Related Commands

dellnsfmaimgrp

Attributes

Log: Yes State: Active Privilege: 1–2

Example 1-21 Add lines 1 and 2 to IMA group 2

```
spirit4.1.18.AUSM.a > addlns2aimgrp 2 1.  
spirit4.1.18.AUSM.a >
```

addport

Use the **addport** command to add a service port to the shelf's configuration.

Full Name

Add a Port

Card(s) on Which This Command Executes

PXM, FRSM, CESM

Related Commands

addportlpbk, cnfport, delport, dspport, dspports

Attributes

Log: Yes State: Active Privilege: 1 (Any on PXM)

Syntax: PXM OC-3

addport <port_number> <line_number> <percent_bandwidth> <min_vpi> <max_vpi>

Syntax Description

<i>port_number</i>	OC-3 Port number to be added, in the range 1–32.
<i>line_number</i>	OC-3 line number. Enter the value 4.
<i>percent_bandwidth</i>	Percentage of bandwidth to be allocated to the port, in the range 1–100.
<i>min_vpi</i>	VPI (Virtual Path Identifier) value, in the range 0–4095.
<i>max_vpi</i>	VPI (Virtual Path Identifier) value, in the range 0–4095.

Syntax: PXM OC-12 back cards

addport <port_number> <line_number> <percent_bandwidth> <min_vpi> <max_vpi>

Syntax Description

<i>port_number</i>	OC-12 port number to be added, in the range 1–32.
<i>line_number</i>	OC-12 line number. Enter the value 1.
<i>percent_bandwidth</i>	Percentage of bandwidth to be allocated to the port, in the range 1–100.
<i>min_vpi</i>	VPI (Virtual Path Identifier) value, in the range 0–4095.
<i>max_vpi</i>	VPI (Virtual Path Identifier) value, in the range 0–4095.

Syntax: PXM T3/E3 back cards

addport <port_number> <line_number> <percent_bandwidth> <min_vpi> <max_vpi>

Syntax Description

<i>port_num</i>	Port number, in the range 1–32.
<i>line_num</i>	T3/E3 line number. Enter the value 2.
<i>Pc_bw</i>	Percentage of bandwidth to be allocated to the port, in the range 1–100.
<i>min_vpi</i>	Virtual Path Identifier (VPI) value, in the range 0–4095.
<i>max_vpi</i>	VPI value, in the range 0–4095.

Syntax: FRSM-8T1E1 cards

addport <port_num> <line_num> <ds0_speed> <begin_slot> <num_slot> <port_type>

Syntax Description

<i>port_num</i>	Port number of either the FRSM-8T1 or the FRSM-8E1. <ul style="list-style-type: none">• FRSM-8T1 range = 1–192• FRSM-8E1 range = 1–248
<i>line_num</i>	FRSM-8T1E1 line number, in the range 1–8.
<i>ds0_speed</i>	Value to set bit rate as either 56 Kbps or 64 Kbps for the DS0. <ul style="list-style-type: none">• 1 = 56 Kbps• 2 = 64 Kbps
<i>begin_slot</i>	Value to set the beginning timeslot number in the T1 or E1 frame.
<i>num_slot</i>	Number of consecutive timeslots in the T1 or E1 frame.
<i>port_type</i>	Value to set service as frame relay, FUNI, or frame forwarding. <ul style="list-style-type: none">• 1 = Frame Relay• 2 = FUNI• 3 = frame forwarding

Syntax: FRSM-2T3E3 cards

addport <port_num> <line_num> <ds0_speed> <begin_slot> <num_slot> <port_type>

Syntax Description

<i>port_num</i>	Port number on the FRSM-2T3 or FRSM-2E3, in the range 1–2.
<i>line_num</i>	FRSM-2T3E3 line number in the range 1–2.
<i>ds0_speed</i>	Value to set bit rate as either 56 Kbps or 64 Kbps for the DS0. <ul style="list-style-type: none"> • 1 = 56 Kbps • 2 = 64 Kbps
<i>begin_slot</i>	Value to set the beginning timeslot number in the T1 or E1 frame.
<i>num_slot</i>	Value to set the beginning timeslot number in the T1 or E1 frame.
<i>port_type</i>	Value to set service as frame relay, FUNI, or frame forwarding. <ul style="list-style-type: none"> • 1 = Frame Relay • 2 = FUNI • 3 = frame forwarding

Syntax: FRSM-2CT3

addport <port_num> <line_num> <ds0_speed> <begin_slot> <num_slot> <port_type>

Syntax Description

<i>port_num</i>	Port number on the FRSM-2CT3, in the range 1–256.
<i>line_num</i>	FRSM-2CT3 line number in the range 1–56.
<i>ds0_speed</i>	Value to set bit rate as either 56 Kbps or 64 Kbps for the DS0. <ul style="list-style-type: none"> • 1 = 56 Kbps • 2 = 64 Kbps
<i>begin_slot</i>	Value to set the beginning timeslot number in the T1 or E1 frame.
<i>num_slot</i>	Value to set the beginning timeslot number in the T1 or E1 frame.
<i>port_type</i>	Value to define service as Frame Relay, FUNI, or frame forwarding. <ul style="list-style-type: none"> • 1 = Frame Relay • 2 = FUNI • 3 = frame forwarding

Syntax: FRSM-HS1/B

addport <port_num> <port_type>

Syntax Description

<i>port_num</i>	Port number, in the range appropriate for the interface type. <ul style="list-style-type: none">• X.21 range = 1-4• HSSI range = 1-2
<i>port_type</i>	Value to set service as Frame Relay, FUNI, or frame forwarding. <ul style="list-style-type: none">• 1 = Frame Relay• 2 = FUNI• 3 = frame forwarding

Syntax: FRSM-HS2

addport <port_num> <line_num> <ds0_speed> <begin_slot> <num_slot> <port_type>

Syntax Description

<i>port_num</i>	Port number on the FRSM-HS2, in the range 1–2.
<i>line_num</i>	FRSM-HS2 line number, in the range 1–2.
<i>ds0_speed</i>	Value to set bit rate as either 56 Kbps or 64 Kbps for the DS0. <ul style="list-style-type: none">• 1 = 56 Kbps• 2 = 64 Kbps
<i>begin_slot</i>	Value to set the beginning timeslot number in the T1 or E1 frame.
<i>num_slot</i>	Value to set the beginning timeslot number in the T1 or E1 frame.
<i>port_type</i>	Value to set service as Frame Relay, FUNI, or frame forwarding. <ul style="list-style-type: none">• 1 = Frame Relay• 2 = FUNI• 3 = frame forwarding

Syntax: CESM-8T1E1 cards

addport <port_num> <line_num> <ds0_speed> gin_slot <num_slot> <port_type>

Syntax Description

<i>port_num</i>	Port number on the CESM-8T1 or CESM-8E1 card. <ul style="list-style-type: none"> • CESM-8T1 range = 1–192 • CESM-8E1 range = 1–248
<i>line_num</i>	CESM-8T1E1 line number, in the range 1–8.
<i>begin_slot</i>	Value to set the beginning timeslot number in the T1 or E1 frame.
<i>num_slot</i>	Value to set the beginning timeslot number in the T1 or E1 frame.
<i>port_type</i>	Value to set service as either structured, unstructured, or framing on VC disconnect. <ul style="list-style-type: none"> • 1 = structured • 2 = unstructured • 3 = framing on VC disconnect

Syntax: CESM-T3E3 cards

addport <port_num> <line_num>

Syntax Description

<i>port_num</i>	Port number. Enter the value 1.
<i>line_num</i>	Line number. Enter the value 1.

Example 1-22 Add port 1 on line 1 with DS0 timeslots 1 through 24 assigned as structured.

```
node501.1.1.CESM.a > addport 1 1 1 24 1
node501.1.1.CESM.a >
```

addred

Use the **addred** command to link two MGX 8800 series slots (a primary slot and a secondary slot) so that the switch treats the cards in these slots as a redundant pair of cards.

The secondary slot should be in the same half of the shelf (upper or lower) as the primary slot. Redundancy can be 1:1 or 1:*N*. If the redundancy is 1:*N*, you must link one secondary slot to *N* primary slots through multiple executions of this command.

Full Name

Add Redundancy

Card(s) on Which This Command Executes

PXM

Syntax

addred <*redPrimarySlotNum*> <*redSecondarySlotNum*> <*RedType*>

Syntax Description

redPrimarySlotNum Slot number that contains the primary card of the card pair, in the ranges 1–6, or 9–14, or 17–22, or 25–30.

redSecondarySlotNum Slot number that contains the secondary card of the card pair, in the ranges 1–6, or 9–14, or 17–22, or 25–30.

RedType Value to set type of redundancy to be deployed on the PXM.

1 = 1:1

2 = 1:*n*

Related Commands

dspre, **delred**

Attributes

Log: No

State: Active

Privilege: Any

Example 1-23 Add 1:1 redundancy between the card in slot 4 and the card in slot 1

```
node501.1.7.PXM.a > addred 1 4 1
node501.1.7.PXM.a >
```

A system response does not occur unless a system error is detected.

addrscprtn

Use the **addrscprtn** command to configure resource partitions for the current PXM.

A resource partition on a PXM consists of a percentage of bandwidth, a VPI/VCI range, and the number of global logical connection numbers (GLCNs) available to a network control application. The network control applications are Portable AutoRoute (PAR) and Tag Switching. The configuration should reflect future development plans for PNNI or other controllers.

Note On a virtual trunk, the *min_vpi* and *max_vpi* should be the same. Only a routing node can support virtual trunking.

Full Name

Add Resource Partition

Card(s) on Which This Command Executes

PXM

Syntax

```
addrscprtn <if_num> <ctrlr_num> <ingr_pct_bw> <egr_pct_bw> <min_vpi> <max_vpi>
<min_vci> <max_vci> <max_chans>
```

Syntax Description

<i>if_num</i>	Logical interface number, in the range 1– 32.
<i>ctrlr_num</i>	Value to set type of network control application to be used on the logical interface. <ul style="list-style-type: none"> • 1 = PAR • 2 = PNNI • 3 = TAG
<i>ingr_pct_bw</i>	Percentage of ingress bandwidth to be allocated on the interface, in the range 0–100.
<i>egr_pct_bw</i>	Percentage of egress bandwidth to be allocated on the interface, in the range 0–100.
<i>min_vpi</i>	Minimum Virtual Path Indicator value, in the range 0–65535.
<i>max_vpi</i>	Maximum Virtual Path Indicator value, in the range 0–4095.
<i>min_vci</i>	Minimum Virtual Channel Indicator value, in the range 0–65535.
<i>max_vci</i>	Maximum Virtual Channel Indicator value, in the range 0–65535.
<i>max_chans</i>	Maximum Global Logical Connection Numbers, in the range 0–32767.

Related Commands

cnfrscrptn, delrscrptn, dspifrc, dspifs, dsprscrptns, dsprscrptn, dsplnrsc

Attributes

Log: No

State: Any

Privilege: Any

addserialif

Use the **addserialif** command to add a serial interface.

Full Name

Add Serial Interface

Card(s) on Which This Command Executes

PXM

Syntax

addserialif <*serial_port_num*>

Syntax Description

serial_port_num Serial port number. Enter the value 1 (for console) or 2 (for slip).

Related Commands

cnfserialif, **dspserialif**

Attributes

Log: Yes State: Active Privilege: Any

Example 1-24 Configure the speed on slip for 19200bps

```
NODENAME.1.7.PXM.a > addserialif 1
```

```
NODENAME.1.7.PXM.a >
```

addtrapmgr

Use the **addtrapmgr** command to set up an SNMP trap manager for use with stand-alone applications. A trap manager registered (added) and reregistered through the SNMP interface by Cisco WAN Manager is deregistered (deleted) after 30 minutes if it is not reregistered. Trap managers that are added using the **addtrapmgr** command will not age, and will not be deleted after 30 minutes.

Full Name

Add Trap Manager

Card(s) on Which This Command Executes

PXM

Syntax

addtrapmgr <ipaddr> <portnum>

Syntax Description

<i>ipaddr</i>	32-bit IP address in dotted decimal format. This setting is the IP address assigned to the port on the trap manager.
<i>portnum</i>	Port number on the trap manager workstation to be used to receive traps. Default = 162.

Related Commands

deltrapmgr, cnftrapmgr, dsptrapmgr, xcnftrapmgr

Attributes

Log: Yes State: Active Privilege: Any

Example 1-25 Add a trap manager with the IP address of 161.10.144.56 to port 162

```
node501.1.7.PXM.a > addtrapmgr 161.10.144.56 162
node501.1.7.PXM.a >
```

addtrk

Use the PAR **addtrk** command to activate a specified trunk on the current PXM.

The **addtrk** command applies only to routing node implementation. Execute **addtrk** after you have partitioned resources for PAR by using **addrscprtn** and configured the broadband interface as a trunk by using **cnfifastrk**.

Note Traffic class and max vpc conids should match before executing the **addtrk** command.

Full Name

Add Trunk

Card(s) on Which This Command Executes

PXM

Syntax

addtrk <slot,port>

Syntax Description

slot.port Port identifier of the trunk to activate, using the format slot.port.

- slot ranges = 1–6, or 9–14, or 17–22, or 25–30
- port range = 1–*n*, as appropriate for the physical installation

Related Commands

cnftrk, **dsptrkcnf**, **dsptrkload**, **dsptrks**

Attributes

Log: No State: Active Privilege: 1

Example 1-26 Activate the trunk on port 4 in the card in slot 1

```
node501.1.7.PXM.a > addtrk 1.4
node501.1.7.PXM.a >
```

adduser

Use the **adduser** command to configure a user name and associated access level on the PXM.

Full Name

Add User

Card(s) on Which This Command Executes

PXM

Syntax

adduser <user ID> <accessLevel>

Syntax Description

user ID

Name to be used as the login at the PXM.

- The name can consist of up to 12 characters composed of alpha and numeric characters, special characters “_” and “-”.
- The name must begin with an alpha character and cannot contain spaces. The name is case sensitive.

accessLevel

System privilege level to be allocated for the user ID.

- GROUP1 (highest level)
- GROUP2
- GROUP3
- GROUP4
- GROUP5
- ANYUSER (lowest level)

The new user that you configure cannot have an access level that is higher than that defined for the current login ID.

Related Commands

dspusers, deluser

Attributes

Log: Yes

State: Active

Privilege: 5–6

Example 1-27 Add a user named fin with privilege level ANYUSER

```
spirit.1.7.PXM.a > adduser fin ANYUSER
```

```
Enter password:
```

```
Re-enter password:
```

```
spirit.1.7.PXM.a >
```

agetrapmgr

Use the **agetrapmgr** command to activate or deactivate aging on trap managers.

Full Name

Age Trap Manager

Card(s) on Which This Command Executes

PXM

Syntax

agetrapmgr <ip_addr> <aging>

Syntax Description

<i>ip_addr</i>	IP address in dotted decimal format. Use ip_addr 0.0.0.1 for all managers.
<i>aging</i>	Value to enable or disable aging of either the individual trap managers, or all trap managers. <ul style="list-style-type: none">• 1 = enable (default)• 2 = disable If enabled, the trap manager is deleted from the table after a period of 30 minutes.

Related Commands

dsptrapmgr

Attributes

Log: No State: Any state Privilege: 1–6

aimhelp

Use the **aimhelp** command to display the Help screen for the AUSM service module.

Full Name

AIM Help

Card(s) on Which This Command Executes

AUSM

Syntax

aimhelp

Related Commands

help

Attributes

Log: No

State: Any state

Privilege: 1–6

Example 1-28 Display the Help screen for the AUSM service module

```
raviraj.1.9.AUSM8.a > aimhelp
```

```
AUSM-8P Commands
```

```

addcon          : Add a Connection
addimagrp      : Add an IMA group
addln          : Add a line
addlnloop     : Configure a line in local loopback
addlns2imagrp : Add lines to an existing IMA group
clralmcount    : Clear DS1 alarm count
clralmcounts   : Clear alarm count for all DS1 lines
clralm         : Clear the DS1 line alarms
clrchancount   : Clear Channel Counters
clrchancounts  : Clear Channel Counters for all channels
clralms        : Clear DS1 alarms on all lines
clrimagrpcount : Clear IMA group Counters
clrimalmcount  : Clear IMA counters on a particular line
clrportcount   : Clear Port Counters
clrportcounts  : Clear Port Counters for all ports
clrsarcnt      : Clear SAR channel counters
clrsarcnts     : Clear SAR counters for all channels
clrsiftst      : Clear self test results
clrimatst      : clear IMA test procedure

```

```
Type <CR> to continue, Q<CR> to stop:
```

```

cnfchanfst     : Configure the channel foresight parameters
cnfchanq       : Configure the channel queue parameters
cnffst         : Configure foresight params of a card
cnfportq       : Configure Egress queue parameters
cnfimagr       : Configure an IMA group
cnfilmi        : Configure ILMI parameters of a port
cnfln          : Configure DS1/E1 line
cnflnloop     : Configure DS1/E1 line
cnfplpp        : Configure DS1/E1 line
cnfslftst      : Configure self test parameters
cnfsvcrange    : Partition Resource between PVCs & SVCs
cnfupccbr      : Configure UPC parameters of CBR connection
cnfupcvbr      : Configure UPC parameters of VBR connection
cnfupcabr      : Configure UPC parameters of ABR connection
cnfupcubr      : Configure UPC parameters of UBR connection
cnfimatst      : Enable the IMA test procedure
cnfimaalmparm  : Configure the IMA alarm Integration UP and DOWN times
copychans      : Copy a template connection
delimagrp      : Delete an IMA group

```

```
Type <CR> to continue, Q<CR> to stop:
```

```

delcon         : Delete a connection
delln          : Delete DS1 line
dellnloop     : Remove a DS1 line from local loopback
dellnsfmimagrp : Delete lines from an existing IMA group
dnport        : Down an ATM port
dspalm         : Display DS1 alarms on a line
dspalmcnf     : Display DS1 alarm configuration
dspalmcount   : Display alarm count for DS1 line
dspalms       : Display DS1 alarms on all lines
dspcd         : Display card information
dspchancount  : Display channel counters
dspcon        : Display connection configuration
dspcons       : Display all the configured connections
dspfeature    : Display the features
dspfst        : Display the card Foresight params
dspilmi       : Display ILMI parms of a port

```



```

dspilmicnt      : Display ILMI counters of a port
dspimagrp      : Display all parms configured for an IMA group
dspimagrpcent  : Display IMA group Counters

```

Type <CR> to continue, Q<CR> to stop:

```

dspimagrps     : Display the configured IMA groups
dspimalncnt   : Display IMA counters on a particular line
dspimatst     : Display IMA test status
dspimaln      : Display IMA link status
dspimaalmparm : Display IMA alaram integration times
dspln         : Display DS1 line
dsplns        : Display all DS1 lines
dsploads      : Display the total bandwidth used up in each port
dspplpp       : Display the PLPP configuration of each line
dspport       : Display the configured ATM/IMA port
dspportcnt    : Display Port Counters
dspportq      : Display the egress queue configuration
dspportqs     : Display configuration of all egress queues
dspports      : Display the configured ATM/IMA ports
dsparscnt     : Display the SAR counters of a connection
dsparscnts    : Display the SAR counters of all connections
dspslftst     : Display self test configuration
dspslftsttbl  : Display the self test results
dspstatparms  : Display the statistics params configured

```

Type <CR> to continue, Q<CR> to stop:

```

dspsvcrange   : Display the resource partition between PVCs & SVCs
dsptotals     : Display the total connections configured per port
runslftstno   : Run a particular self test
tstcon        : Test the connection towards the N/W side
tstconseg     : Test the connection towards the CPE side
tstconsti     : Test the connection towards the N/W side using STI supervisor
ory cell
tstdelay      : Measure the delay towards the N/W side
tstdelaysti   : Measure the delay towards the N/W side using STI supervisor
y cell
upport        : Up an ATM port
xcnfalm       : Configure alms of a DS1 line
xcnfln        : Configure a DS1 line
xcnfln        : Configure a DS1 line

```

raviraj.1.9.AUSM8.a >

arpAdd

Use the **arpAdd** command to add an Address Resolution Protocol (ARP) entry to the ARP table. This Internet protocol is used to map an IP address to a MAC address, and the ARP table contains these translations.

Full Name

Add Address Resolution Protocol Entry

Card(s) on Which This Command Executes

PXM

Syntax

```
arpAdd <ip_addr> <mac_address>
```

Syntax Description

<i>ip_addr</i>	IP address in dotted decimal format.
<i>mac_address</i>	Standardized data link layer address, 6 bytes long. Also known as a hardware address, MAC-layer address, and physical address.

Related Commands

arpShow, arpDelete, arpFlush

Attributes

Log: No State: Any state Privilege: 1–6

Example 1-29 Add an ARP entry on the current PXM, then show the ARP entry

```
NODENAME.1.7.PXM.a > arpAdd 172.29.36.102 0:e0:4f:5c:6c:5a

NODENAME.1.7.PXM.a > arpShow
172.29.36.28 at 8:0:20:a6:80:3b
190.29.36.255 at 0:e0:4f:5c:6c:20
172.29.36.102 at 0:e0:4f:5c:6c:5a
171.71.54.104 at 0:e0:4f:5c:6c:20
NODENAME.1.7.PXM.a >
```

arpDelete

Use the **arpDelete** command to delete an entry in the Address Resolution Protocol (ARP) table. The ARP protocol is used to map an IP address to a MAC address, and the ARP table contains these translations.

Full Name

Delete Address Resolution Protocol Entry

Card(s) on Which This Command Executes

PXM

Syntax

arpDelete <*ip_address*>

Syntax Description

ip_addr IP address in dotted decimal format.

Related Commands

arpAdd, arpShow, arpFlush

Attributes

Log: No State: Any state Privilege: 1–6

Example 1-30 Delete ARP entry for IP address 172.29.36.102

```
NODENAME.1.7.PXM.a> arpDelete 172.29.36.102
172.29.36.102 (172.29.36.102) deleted
NODENAME.1.7.PXM.a>
```

arpFlush

Use the **arpFlush** command to remove non-permanent entries from the ARP table. The ARP protocol is used to map an IP address to a MAC address, and the ARP table contains these translations.

Full Name

Flush Address Resolution Protocol Table

Card(s) on Which This Command Executes

PXM

Syntax

arpFlush

Related Commands

arpAdd, arpDelete, arpShow

Attributes

Log: No State: Any state Privilege: 1–6

Example 1-31 Flush the ARP table, then show the ARP table

```
NODENAME.1.7.PXM.a > arpFlush

NODENAME.1.7.PXM.a > arpShow
171.71.54.104 at 0:e0:4f:5c:6c:20
NODENAME.1.7.PXM.a >
```

arpShow

Use the **arpShow** command to display the Address Resolution Protocol (ARP) table. The ARP table contains IP address to MAC address translations mapped by the ARP protocol.

Full Name

Show Address Resolution Protocol Table

Card(s) on Which This Command Executes

PXM

Syntax

arpShow

Related Commands

arpAdd, arpDelete, arpFlush

Attributes

Log: No State: Any state Privilege: 1–6

Example 1-32 Show the ARP table on the current PXM

```
NODENAME.1.7.PXM.a > arpShow
190.29.36.255 at 0:e0:4f:5c:6c:20
172.29.36.28 at 8:0:20:a6:80:3b
171.71.54.104 at 0:e0:4f:5c:6c:20
NODENAME.1.7.PXM.a >
```

bootChange

Use the **bootChange** command to change to the boot IP address and gateway address of a PXM card. The IP address you define will be used only when the PXM is in boot state. Use the **cnfifip** command to assign IP addresses for the PXM and the shelf. Note that the **bootChange** values are sent and automatically updated on the standby card, and bootlines are synchronized.

The PXM tries to correct bad entries when it boots up. This information is copied to the standby card. If the **bootChange** IP address is different the shelf IP address, then it will bring the ethernet interface up on the standby with the **bootChange** IP address.

The shellconn version of this command updates only the local bootline values.

Note that several parameters are necessary for the network to function; specifically:

- Ethernet interface
- IP address and subnetmask
- Default Ethernet gateway

Note If the firmware fails to reach the CLI prompt or comes up in backup boot, the Ethernet interface could be down, a problem created by an identical shelf IP address and boot change address. In such a case, the **bootChange** command could be used from the shell to set another IP address and then **usrEnetEnable** should be called to activate that address.

If the CLI prompt is not there or if the switch is not enabled and in backup boot, you can use the **usrEnetEnable** command to bring up the Ethernet interface.

Full Name

Boot Change

Card(s) on Which This Command Executes

PXM

Syntax

bootChange

Related Commands

cnfifip, usrEnetEnable

Attributes

Log: Yes State: Active Privilege: SERVICE_GP

Example 1-33 Execute the bootChange on the current PXM

```
raviraj.1.7.PXM.a > bootChange

'.' = clear field; '-' = go to previous field; ^D = quit

boot device          : lnPci
processor number     : 0
host name            :
file name            :
inet on ethernet (e) : 172.29.37.41 : fffffff0
inet on backplane (b):
host inet (h)        :
gateway inet (g)     : 172.29.37.1
user (u)             :
ftp password (pw) (blank = use rsh):
flags (f)            : 0x0
target name (tn)     :
startup script (s)   :
other (o)            :
```

raviraj.1.7.PXM.a >

bye

Use the **bye** command to exit the current CLI shell.

Full Name

Bye

Card(s) on Which This Command Executes

PXM, FRSM, AUSM, VISM

Syntax

bye

Related Commands

logout

Attributes

Log: Yes

State: Any

Privilege: Any

Example 1-34 Exit the current CLI shell.

```
spirit.1.8.PXM.a > bye
```

```
(session ended)
```

CC

Use the **cc** command to navigate from card to card on the shelf.

Full Name

Change Card

Card(s) on Which This Command Executes

PXM, FRSM, AUSM, CESH, VISM

Syntax

cc <slot number>

Syntax Description

slot number The number of the slot that contains the card you want to work on.

Related Commands

None

Attributes

Log: Yes State: Any state Privilege: Any

Example 1-35 Switch from the AUSM in slot 22 to the PXM in slot 8

```
node1.1.22.AUSM8.a > cc 8
(session redirected)
node1.1.8.PXM.a >
```

A system message does not occur unless an error is detected. If the card slot is empty, an error message is presented.

cd

Use the **cd** command to change the current directory on the PXM hard disk.

Full Name

Change Directory

Card(s) on Which This Command Executes

PXM

Syntax

cd <directory_name>

Syntax Description

directory_name Name of the target directory.

Related Commands

ls, pwd, rename, rm/rmdir, deltree, copy

Attributes

Log: Yes State: Any Privilege: Group 3

Example 1-36 Change directory to FW

```
raviraj.1.7.PXM.a > cd FW  
  
raviraj.1.7.PXM.a >
```

Verify the current directory by using the **pwd** command.

Example 1-37 Return to the Root directory

```
raviraj.1.7.PXM.a > pwd  
C:FW  
  
raviraj.1.7.PXM.a > cd ..  
  
raviraj.1.7.PXM.a > pwd  
C:  
  
raviraj.1.7.PXM.a >
```

clraimgrpnt

Use the **clraimgrpnt** command to clear all the AIMUX-related counters for all lines in the specified AIMUX group.

Full Name

Clear AIM Group Counters

Card(s) on Which This Command Executes

AUSM

Syntax

clraimgrpnt <*imagroup*>

Syntax Description

imagroup The number of the AIMUX group number on which you want to clear the AIMUX counters, in the range 1–8.

Related Commands

delaimgrpnt

Attributes

Log: Yes State: Active Privilege: 1–2

Example 1-38 Clear all the AIM group counters in AIM group 8

```
node1.1.22.AUSM8.a > clraimgrpnt 8
node1.1.22.AUSM8.a >
```

clraimlncnt

Use the **clraimlncnt** command to clear all the AIMUX line counters for the specified IMA group.

Full Name

Clear AIM (or Clear IMA) Line Counters

Card(s) on Which This Command Executes

AUSM

Syntax

clraimlncnt (or **clrimalnct**) *<imagroup>* *<linenum>*

Syntax Description

imagroup The number of the AIMUX group on which you want to clear the line counters associated with an IMA group, in the range 1–8.

linenum Line number, in the range 1–8.

Related Commands

dspaimlncnt, **clrimalnct**

Attributes

Log: No State: Active Privilege: 1

Example 1-39 Clear all the AIM line counters in AIM group 8

```
node1.1.22.AUSM8.a > clraimlncnt 8  
node1.1.22.AUSM8.a >
```

clrallcnf

Use the **clrallcnf** command to clear all configuration elements for all the cards in the node. The system will query for confirmation before executing the **clrallcnf** command.

Warning Take care when using this command. This will clear all configuration files on the PXM.

Full Name

Clear All Configurations

Card(s) on Which This Command Executes

PXM

Syntax

clrallcnf

Related Commands

None

Attributes

Log: Yes State: Active Privilege: 1-3

Example 1-40 Clear Configuration Confirmation Query

```
node1.1.7.PXM.a > clrallcnf

All SM's config will be deleted, and
the shelf will be reset.
Do you want to proceed (Yes/No)? No
(command not executed)

node1.1.7.PXM.a >
```

clralm

Use the **clralm** command to clear alarms on a specified line on the current card. Alarms occurring after this command executes are not affected. If alarms on a line are cleared with this command, the results may be observable through the **dspalm** command.

This command can clear alarms caused by the collection of statistical data only. Alarms caused by network failure cannot be cleared. For example, an alarm caused by a collection of bipolar errors can be cleared, but an alarm caused by a card failure cannot.

Full Name

Clear Alarm

Card(s) on Which This Command Executes

PXM, FRSM, AUSM, CESM, VISM

Syntax: PXM

clralm -ds3 <LineNum>

or

clralm -e3 <LineNum>

or

clralm -sonet <LineNum>

or

clralm -plcp <PLCPNUM>

Syntax Description

- ds3** *LineNum* DS3 line number on which to clear alarms, using the format *slot.port*.
 - slot = enter a value from the range 7, 8, 15, 16, 31, 32
 - port range = 1–*n*, as appropriate for the physical installation
- e3** *LineNum* E3 line number on which to clear alarms, using the format *slot.port*.
 - slot = enter a value from the range 7, 8, 15, 16, 31, 32
 - port range = 1–*n*, as appropriate for the physical installation
- sonet** *LineNum* SONET line number in the format *slot.port*.
 - slot = enter the value either 7 or 8
 - port range = 1–*n*, as appropriate for the physical installation
- plcp** *PLCPNUM* Physical Layer Protocol Processor number, in the range 1–*n*.
 - line number = enter a value from the range 7, 8, 15, 16, 31, 32

Syntax: FRSM, AUSM, CESH, or VISM

clralm -ds1 <LineNum>

Syntax Description

- LineNum*
- FRSM
 - 8T1: for DS1, enter a value in the range 1–8
 - HS1/B: for X.21 enter a value in the range 1–4
 - AUSM, enter a value in the range 1–8
 - CEAM: for CESH_8P enter a value in the range 1–8

Syntax: SRM-3T3

clralm <-srmds3> <LineNum>

Syntax Description

- *LineNum* LineNum = 1–*n*, where *n* = 3 if SRM-3T3

Syntax: FRSM-HS1

clralm -hs1 <LineNum>

Syntax Description

- LineNum* LineNum = 1–*n*, where *n* = 4 if FRSM

Related Commands

clralms, dspalm, dspalms

Attributes

Log: No State: Any Privilege: 5–6

Example 1-41 Clear all the alarms caused by the collection of statistical data for line 1 on the current card

```
node1.1.22.AUSM8.a > clralm -ds1 1
node1.1.22.AUSM8.a >
```

clearalrmnt

Use the **clearalrmnt** command to clear all the alarm counters and statistics on the specified line on the current card. All counters are reset to 0. The terminal does not display a response unless an error exists in the syntax.

Full Name

Clear Alarm Counters

Card(s) on Which This Command Executes

PXM, FRSM, AUSM, CESM, VISM

Syntax: PXM

clearalrmnt -ds3 <LineNum>

clearalrmnt -e3 <LineNum>

clearalrmnt -sonet <LineNum>

clearalrmnt -plcp <PLCPNUM>

Syntax Description

- | | |
|------------------------------|---|
| -ds3 <i>LineNum</i> | DS3 line number in the format <i>slot.port</i> <ul style="list-style-type: none"> • slot = enter a value from the range 7, 8, 15, 16, 31, 32 • port range = 1–n, as appropriate for the physical installation |
| -e3 <i>LineNum</i> | E3 line number in the format <i>slot.port</i> <ul style="list-style-type: none"> • slot = enter a value from the range 7, 8, 15, 16, 31, 32 • port range = 1–n, as appropriate for the physical installation |
| -sonet <i>LineNum</i> | SONET line number in the format <i>slot.port</i> <ul style="list-style-type: none"> • slot = enter the value either 7 or 8 • port range = 1–n, as appropriate for the physical installation |
| -plcp <i>PLCPNUM</i> | Physical Layer Protocol Processor value. Range: 1–n, as appropriate for the physical installation. <ul style="list-style-type: none"> • slot = enter a value from the range 7, 8, 15, 16, 31, 32 |

Syntax: FRSM, AUSM, CESM, or VISM

clralmct -ds1 <LineNum>

Syntax Description

LineNum Line number, in the range appropriate for the card.

- FRSM range = 1–8
- AUSM range = 1–8
- CESM range = 1–8

Related Commands

dspalment, clralments

Attributes

Log: No

State: Any

Privilege: Any (5 on PXM)

Example 1-42 Clear all the alarm counters and statistics collected for line 1 on the current card

```
node1.1.22.AUSM8.a > clralmct -ds1 1
node1.1.22.AUSM8.a >
```

clralmcnts

Use the **clralmcnts** command to clear all the alarm counters and statistics on the current card. All counters are reset to 0. The terminal does not display a response unless an error exists in the syntax.

Full Name

Clear All Alarm Counters/Statistics on the Current Card.

Card(s) on Which This Command Executes

FRSM, AUSM, CESM, VISM

Syntax

clralmcnts

Related Commands

dspalment, clralment

Attributes

Log: No State: Any Privilege: 1–5

Example 1-43 Clear all the alarm counters and statistics collected for the current card

```
node1.1.22.AUSM8.a > clralmcnts
node1.1.22.AUSM8.a >
```

clralms

The **clralms** command clears alarms on the current card. Alarms occurring after this command executes are not affected.

This command can clear alarms caused by the collection of statistical data only. Alarms caused by network failure cannot be cleared. For example, an alarm caused by a collection of bipolar errors can be cleared, but an alarm caused by a card failure cannot.

Full Name

Clear Alarms on Card

Card(s) on Which This Command Executes

FRSM, AUSM, CESM, VISM

Syntax: FRSM, AUSM, CESM, or VISM

clralms -ds1 <LineNum>

Syntax Description

LineNum Line number on which to clear alarms, in the range 1–*n*, as appropriate for the physical installation.

Related Commands

clralm, **dspalm**, **dspalms**

Attributes

Log: No State: Any Privilege: 1–5

Example 1-44 Clear all the alarms triggered by the collection of statistics for line 1 on the current card

```
node1.1.22.AUSM8.a > clralms -ds1 1
node1.1.22.AUSM8.a >
```

clratmlncnt

The **clratmlncnt** clears the ATM event counters for the specified line on the PXM.

Full Name

Clear All ATM Line Counters on the Specified Line Number

Card(s) on Which This Command Executes

PXM

Syntax

clratmlncnt <line_num>

Syntax Description

line_num Line number on which to clear the ATM event counters, in the range 1–4.

Related Commands

clratmlncnts

Attributes

Log: No State: Any Privilege: Any

Example 1-45 Clear all the ATM event counters for line 1 on the PXM

```
node1.1.7.PXM.a > clratmlncnt 1
node1.1.7.PXM.a >
```

clratmlncnts

Use the **clratmlncnts** command to remove all ATM counters on all the lines on the current card.

Full Name

Clear all ATM Line Counters on All Lines

Card(s) on Which This Command Executes

PXM

Syntax

clratmlncnts

Related Commands

clratmlncnt

Attributes

Log: No

State: Any

Privilege: Any

Example 1-46 Clear all the ATM event counters on the PXM

```
node1.1.7.PXM.a > clratmlncnts
node1.1.7.PXM.a >
```

clrbertcntrs

Use the **clrbertcntrs** command to remove all counters associated with bit error rate testing.

Full Name

Clear BERT counters

Card(s) on Which This Command Executes

FRSM 2CT3, CESMT3

Syntax

clrbertcntrs

Related Commands

acqdsx3bert, cnfdsx3bert, deldsx3bert, dspdsx3bert, startdsx3bert, xcnfdsx3bert, xdspdsx3bert

Attributes

Log: No State: Any Privilege: Any

Example 1-47 Clear all BERT counters on the current FRSM

```
raviraj.1.13.VHS2CT3.a > dspdsx3bert
undefined symbol: dspdsx3bert

raviraj.1.13.VHS2CT3.a >
```

clrcderrs

The **clrcderrs** command clears all card-related errors in an MGX 8800 series card. No response messages appear on screen. Refer to the **dspcderrs** description to see an example of the errors that this command clears, or execute the **dspcderrs** command before and after executing the **clrcderrs** command.

Full Name

Clear Hardware/Reset Errors in BRAM

Card(s) on Which This Command Executes

FRSM, AUSM

Syntax

clrcderrs

Related Commands

dspcderrs

Attributes

Log: No

State: Any

Privilege: SuperUser

Example 1-48 Clear all the card-related errors on the FRSM in slot 4

```
node1.1.4.FRSM.a > clrcderrs  
node1.1.4.FRSM.a >
```

clrchanct

Use the **clrchanct** command to clear the channel counters for the specified channel on the current card. Counting resumes after the command executes.

The Frame Relay counters for each channel are

- Received frames: bytes, DE, discarded, FECN, BECN
- Received frames tagged FECN, BECN, DE
- Received frames discarded for shelf alarms, exceeded queue depth, exceeded queue depth, exceeded DE threshold
- Received bytes: DE, discarded
- Transmitted bytes: DE, discarded
- Transmitted bytes discarded for exceeded queue depth
- Transmitted bytes during for LMI logical port alarm
- Transmitted frames tagged FECN, BECN
- Transmitted frames: bytes, BECN, FECN, DE
- Transmitted frames during LMI logical port alarm
- Transmitted frames discarded for exceeded queue depth, exceeded DE threshold, CRC error, physical layer fail, source abort, reassembly failure

Full Name

Clear Channel Counters on a Specified Channel

Card(s) on Which This Command Executes

PXM, FRSM, AUSM, CESH

Syntax: PXM

clrchanct -cnt <chanNum> -cc <clrButton>

Syntax Description

-cnt	Command delineator that precedes the PXM <i>channel number</i> entry.
<i>channel number</i>	PXM channel number, in the range 16–4111.
-cc	Command delineator that precedes the <i>cntClrButton</i> entry.
<i>clrButton</i>	Value to set the underline MIB object to clear or retain the counters. <ul style="list-style-type: none"> • 1 = no action • 2 = clear counts (default)

Syntax: FRSM

clrchancnt <*chan_num*>

Syntax Description

chan_num Channel number, in the range appropriate for the card.

- FRSM range = 16–1015
- CESM range = 32–279

Syntax: AUSM

clrchancnt <*Port.VPI.VCI* | *Chan_num*>

Syntax Description

Port.VPI.VCI Connection number, in the format *port.VPI.VCI*.

Chan_num Channel number, in the range 16–1015.

Related Commands

dspchan, clrchancnts, dspchancnt

Attributes

Log: Yes State: Any Privilege: Any

Example 1-49 Clear all the channel counters for channel 16 on the FRSM in slot 4

```
node1.1.4.FRSM.a > clrchancnt 16
node1.1.4.FRSM.a >
```

clrchannts

Use the **clrchannts** command to clear all channel counters for all channels on the current service card. The counters resume accruing after the command executes. To view a list of the Frame Relay counters, refer to the description of **clrchannt**.

Full Name

Clear All Channel Counters on the Card

Card(s) on Which This Command Executes

PXM, FRSM, AUSM, CESM

Syntax

clrchannts

Related Commands

dspchan, clrchannt, dspchannt

Attributes

Log: Yes State: Any Privilege: 1–3 (Any on PXM)

Example 1-50 Clear all the channel counters for all channels on the FRSM in slot 4

```
node1.1.4.FRSM.a > clrchannts  
node1.1.4.FRSM.a >
```

clrconcnt

Use the **clrconcnt** command to clear the counters for the specified Connection Identifier on the current PXM card. Counting resumes after the command executes.

Full Name

Clear Connection Counters for a Specified Connection Identifier

Card(s) on Which This Command Executes

PXM

Syntax

clrconcnt <conn_ID>

Syntax Description

- conn_ID* Connection ID, in the format *PortNum.VPI.VCI*
- *PortNum* = 1–*n*, as appropriate for the physical installation
 - *VPI* = virtual path identifier in the range for either UNI or NNI
 - UNI range = 0–255 (typically applied to lines that connect standalone node to a workstation)
 - NNI range = 0–4095
 - *VCI* = virtual circuit identifier in the range 0–65535

Related Commands

dspon, clrconcnts, dsponcnt, dsponcnts

Attributes

Log: Yes State: Any Privilege: Any

Example 1-51 Clear all the counters for the connection on port 1 with a VPI of 2 and a VCI of 2

```
node4.1.8.PXM.a > clrconcnt 1.2.2
node4.1.8.PXM.a >
```

clrconcnts

Use the **clrconcnts** command to clear the counters for all the connections on the current PXM card. Counting resumes after the command executes.

Full Name

Clear Connection Counters for All Connections on the Card

Card(s) on Which This Command Executes

PXM

Syntax

clrconcnts

Related Commands

dspon, clrconcnt, dsponcnt, dsponcnts

Attributes

Log: Yes

State: Any

Privilege: Any

Example 1-52 Clear all the counters for all the connections on the PXM card

```
node4.1.8.PXM.a > clrconcnts
node4.1.8.PXM.a >
```

clrerr

Use the **clrerr** command to remove specified or all error log files. This command queries for confirmation prior to clearing the error log files from the system.

Full Name

Clear Error Log Counters for All Connections on the Card

Card(s) on Which This Command Executes

PXM

Syntax:

clrerr [-en <error slot>]

Syntax Description

-en Command delineator that precedes the *error slot* entry.

error slot Number of the log file to clear, which is identical to the slot number of the card.

Related Commands

dsperr

Attributes

Log: No State: Any Privilege: Any

Example 1-53 Clrerr query to proceed.

```
wilco.1.7.PXM.a > clrerr

Do you want to proceed (Yes/No)? No
(command not executed)

wilco.1.7.PXM.a >
```

clrifcnt

Use the **clrifcnt** command to clear the counters for a specified broadband interface.

Full Name

Clear Interface Counters for the Specified Interface

Card(s) on Which This Command Executes

PXM

Syntax

clrifcnt <*if_num*>

Syntax Description

if_num Interface number, in the range 1–32.

Related Commands

clrifcnts

Attributes

Log: No State: Any Privilege: Any

Example 1-54 Clear the counters for the specified broadband interface (1)

```
wilco.1.7.PXM.a > clrifcnt 1  
ilco.1.7.PXM.a >
```

clrifcnts

Use the **clrifcnts** command to clear the counters for all the broadband interfaces.

Full Name

Clear All Interface Counters

Card(s) on Which This Command Executes

PXM

Syntax

clrifcnts

Related Commands

clrifcnt

Attributes

Log: No

State: Any

Privilege: Any

Example 1-55 Clear the counters for all broadband interfaces on the PXM card

```
wilco.1.7.PXM.a > clrifcnts  
wilco.1.7.PXM.a >
```

clrimagrpcnt

Use the **clrimagrpcnt** command to clear Inverse Multiplexing ATM (IMA) group counters on the current AUSM card for a specified IMA group.

Full Name

Clear Inverse Multiplexing ATM Group Counters

Card(s) on Which This Command Executes

AUSM

Syntax

clrimagrpcnt (or **clraimgrpcnt**) <*imagroup*>

Syntax Description

imagroup IMA group number, in the range 1–8.

Related Commands

dspimagrps, dspimagrpcnt, dspimagrps, dspimainfo, dspimalncnt

Attributes

Log: No State: Active Privilege: 1

Example 1-56 Clear all the inverse multiplexing ATM group counters for IMA group 1 on the AUSM card in slot 17

```
flyers01.1.17.AUSM.a > clrimagrpcnt 1  
flyers01.1.17.AUSM.a >
```

clrimalnct

Use the **clrimalnct** command to clear all AIMUX line counters for a specified line in an IMA trunk.

Full Name

Clear AIM (or Clear IMA) Line Counters

Card(s) on Which This Command Executes

AUSM

Syntax

clrimalnct (or **clraimlnct**) *<imagroup>* *<linenum>*

Syntax Description

imagroup AIMUX group number, in the range 1–8.

linenum Line number, in the range 1–8.

Related Commands

dspaimlnct, **clraimlnct**

Attributes

Log: No State: Active Privilege: 1

Example 1-57 Clear all the inverse multiplexing ATM line counters for IMA group 1 on the AUSM card in slot 17

```
flyers01.1.17.AUSM.a > clrimalnct 1  
flyers01.1.17.AUSM.a >
```

clrlmistats

Use the **clrlmistats** command to clear the Local Management Interface (LMI) related statistics on the current PXM.

Full Name

Clear All LMI Statistics

Card(s) on Which This Command Executes

PXM

Syntax

clrlmistats

Related Commands

dsplmistats

Attributes

Log: NoState: AnyPrivilege: Any

Example 1-58 Clear the LMI statistics on the PXM card

```
penguin.1.7.PXM.a > clrlmistats

Enabled          :          1  Port Status      :          1
VPI.VCI         :         3.31
Polling enable   :          1
T393            :          10  N394          :          5
T394            :          10  N395          :          5
WaitStatus      :          0  WaitStAck    :          0
Retry Timer     :          0  Retry Count  :          1
Poll Timer      :          6  Trans Num    :         86
Status Rx       :          0  Status Tx    :          0
UpdtStatus Rx  :          0  UpdtStatus Tx :          0
Status Enq Rx  :          0  Status Enq Tx :          0
Status Ack Rx  :          0  Status Ack Tx :          0
NodeStatus Rx  :          0  NodeStatus Tx :          0
NodeStaAck Rx  :          0  NodeStaAck Tx :          0
Bad PDU Rx     :          0  Bad PDU Len Rx :          0
Unknown PDU Rx :          0  Invalid I.E. Rx:          0
Invalid Trans   :          0
BPX IP Addr     : 172.3.3.62

penguin.1.7.PXM.a >
```

clrlog

Use the **clrlog** command to clear specified or all event log files. The log resumes accumulating event log messages after the command executes. This command queries for confirmation prior to removing all event log files.

Full Name

Clear Log

Card(s) on Which This Command Executes

PXM

Syntax

clrlog [-log <log slot>]

Syntax Description

-log Command delineator that precedes the *log slot* entry.

log slot Number of the file that you want to clear from the event log file.

Related Commands

dsplog

Attributes

Log: Yes State: Any Privilege: 1

Example 1-59 Clear all event log files on the PXM card

```
wilco.1.7.PXM.a > clrlog
Do you want to proceed (Yes/No)? Yes
wilco.1.7.PXM.a >
```

clrmsgcnt

Use the **clrmsgcnt** command to clear the control message counters. The control message counters are for the total numbers of:

- Control frames transmitted to SAR (from RISC) maintained by RISC
- Control frames received from SAR (to RISC) maintained by RISC
- Control frames transmitted to RISC from SAR maintained by SAR (should be equal to *riscRcvCtrlMsg*)
- Control frames received to SAR from RISC maintained by SAR (should be equal to *riscXmtCtrlMsg*)
- Control (management) cells discarded due to illegal length error
- Control (management) cells discarded due to illegal CRC error
- Discarded control messages due to unknown channel error

This message also clears the control cell header received on the last unknown channel.

Full Name

Clear Control Message Counters

Card(s) on Which This Command Executes

FRSM, AUSM, CESM, VISM

Syntax

clrmsgcnt

Related Commands

dspmsgcnt

Attributes

Log: NoState: Any Privilege: 1–5

Example 1-60 Clear all the control message counters on the AUSM card in slot 17

```
flyers01.1.17.AUSM.a > clrmsgcnt 1  
flyers01.1.17.AUSM.a >
```

clrportcnt

Use the **clrportcnt** command to clear counter values on a specified port associated with the current PXM, AUSM, or FRSM.

Full Name

Clear Port Counters

Card(s) on Which This Command Executes

PXM, FRSM, AUSM

Syntax

clrportcnt <port_number>

Syntax Description

port_number Port number, as appropriate for the current card.

- PXM range = 1–32
- AUSM range = 1–8
- FRSM
 - T1 = 1–192
 - E1 = 1–248
 - HS1/B
 - X.21 range = 1–4
 - HSSI range = 1–2

Related Commands

clrportcnts, **dspportcnt**

Attributes

Log: NoState: Any Privilege: 1–5 (Any on PXM)

Example 1-61 Clear all the port counters on port 1 on the AUSM card in slot 17

```
flyers01.1.17.AUSM.a > clrportcnt 1
flyers01.1.17.AUSM.a >
```

clrportcnts

Use the **clrportcnts** command to clear all port counters on the current PXM, FRSM, or AUSM.

Full Name

Clear Port Counts

Card(s) on Which This Command Executes

PXM, FRSM, AUSM

Syntax

clrportcnts

Related Commands

clrportcnt, **dspportcnt**

Attributes

Log: NoState: Any Privilege: 1–5

Example 1-62 Clear all the port counters on all the ports on the AUSM card in slot 17

```
flyers01.1.17.AUSM.a > clrportcnts  
flyers01.1.17.AUSM.a >
```

clrsarcnt

On an FRSM or CESM, use the **clrsarcnt** command to clear the Segmentation and Reassembly (SAR) counters for the particular channel in the argument. On an AUSM, use the **clrsarcnt** command to clear the SAR counters for the particular port.VPI.VCI connection.

The SAR counters are

- Number of cells transmitted on this channel.
- Number of CLP cells that were transmitted on this channel.
- Number of AIS cells that were transmitted on this channel.
- Number of FERF cells that were transmitted on this channel.
- Number of BCM cells that were transmitted on this channel.
- Number of End2End loop cells that were transmitted on this channel.
- Number of segment loop cells that were transmitted on this channel.
- Number of cells discard due to Shelf alarm on this channel.
- Number of cells that were received on this channel.
- Number of CLP cells that were received on this channel.
- Number of AIS cells that were received on this channel.
- Number of FERF cells that were received on this channel.
- Number of BCM cells that were received on this channel.
- Number of End2End loop cells that were received on this channel.
- Number of segment loop cells that were received on this channel.
- Number of cells that had the CRC error on this channel.

Full Name

Clear SAR Counters

Card(s) on Which This Command Executes

FRSM, AUSM, CESM, VISM

Syntax for FRSM-8T1E1

clrsarcnt *-chn* <ChanNum | Port.DLCI>

Syntax Description

ChanNum Channel number in the range 16–1015.

Port.DLCI Port number of either the FRSM-8T1 or the FRSM-8E1.

- FRSM-8T1 range = 1–192
- FRSM-8E1 range = 1–248

Data-link connection identifier, in the range 0–1023. This value specifies a PVC or SVC in a Frame Relay network.

Syntax for CESM-8T1E1

clrsarcnt *-chn* <ChanNum>

Syntax Description

ChanNum Channel number in the range 0–279.

Syntax for AUSM-8T1E1

clrsarcnt <port.VPI.VCI>

Syntax Description

port.VPI.VCI Port range = 1–n, as appropriate for the physical installation.

VPI range = 1–4095.

VCI range = 1–65535.

Related Commands

dpsarcnt

Attributes

Log: NoState: Any Privilege: 1–5

Example 1-63 Clear the SAR counters for channel number 20 on the FRSM card

```
NODENAME.1.17.FRSM.a > clrsarcnt -chn 20
NODENAME.1.17.FRSM.a >
```

clrsarcnts

Use the **clrsarcnts** command to clear the Segmentation and Reassembly (SAR) counters for all the channels or connections on the card from which the command is executed.

Full Name

Clear SAR Counts

Syntax

clrsarcnts

Card(s) on Which This Command Executes

FRSM, AUSM, CESM, VISM

Related Commands

clrsarent, dpsarent, dpsarcnts

Attributes

Log: No State: Any Privilege: Any

Example 1-64 Clear all the SAR counters on all the cards in the node

```
flyers01.1.17.AUSM.a > clrsarcnts  
flyers01.1.17.AUSM.a >
```

clrscrn

Use the **clrscrn** command to clear the control terminal screen. After this command executes, only the current command line prompt appears on the screen.

Full Name

Clear Terminal Screen

Card(s) on Which This Command Executes

PXM, FRSM, AUSM, CESH, VISM

Syntax

clrscrn

Related Commands

None

Attributes

Log: No

State: Any

Privilege: Any

Example 1-65 Clear the screen

```
flyers01.1.17.AUSM.a > clrscrn  
flyers01.1.17.AUSM.a >
```

clrsiftst

Use the **clrsiftst** command to clear the results of the last self-test on the current card.

Full Name

Clear Self-Test

Card(s) on Which This Command Executes

FRSM, AUSM, CESM

Syntax

clrsiftst

Related Commands

cnfsiftst, dspsiftst, runsiftstno

Attributes

Log: No

State: Any

Privilege: Any

Example 1-66 Clear the results of the last self-test for the AUSM card in slot 17

```
flyers01.1.17.AUSM.a > clrsiftst  
flyers01.1.17.AUSM.a >
```

clrsmcnf

Use the **clrsmcnf** command to clear the following configuration elements for the selected service card:

- Configuration
- Rate control function
- Channelization on the card
- MIB version

Note Before executing the **clrsmcnf** command, clear (delete) all lines, ports, and channels on the affected service module(s).

Full Name

Clear Service Module Configuration

Card(s) on Which This Command Executes

PXM

Syntax

clrsmcnf <slot number>

Syntax Description

slot number Slot number in the range 1–6, or 9–14, or 17–22, or 25–30.

Related Commands

dspsmcnf

Attributes

Log: Yes State: Active Privilege: 3

Example 1-67 Clear all the configuration elements on the AUSM card in slot 17

```
flyers01.1.1.7.PXM.a > clrsmcnf 17  
flyers01.1.1.7.PXM.a >
```

clsrmcnf

Use the **clsrmcnf** command to clear SRM-3T3 card information and to remove all T1 link mappings. All links are switched back to their respective service modules.

Full Name

Clear SRM-3T3 Configuration

Card(s) on Which This Command Executes

PXM

Syntax

clsrmcnf <slot number>

Syntax Description

slot number Slot number. Enter the value 15 or 31.

- Slot number 15 is used for the cards in slot and 15 and 16 (whichever is active).
- Slot 31 is used for cards in 31 and 32.

Related Commands

addlink, dsplink, xcnsrmlink, xdpsrmlink

Attributes

Log: Yes State: Active Privilege: Any

Example 1-68 Clear all the configuration information and remove all T1 link mappings on the SRM-3T3 card in slot 15

```
flyers01.1.7.PXM.a > clsrmcnf 15
flyers01.1.7.PXM.a >
```

cmdhistory

Use the **cmdhistory** command to view the last 10 commands executed on the current card.

Full Name

Display Command History

Card(s) on Which This Command Executes

PXM

Syntax

cmdhistory

Related Commands

history

Attributes

Log: No

State: Any

Privilege: Any

Example 1-69 Display the previous 10 commands executed on the PXM card

```
spirit4.1.8.PXM.a > cmdhistory

Size of cmdHistory is currently 10 line(s)
 1 dspconcnt 2.39.45
 2 dsplmistats
 3 dsplmiloop
 4 dsplm
 5 clrportcnt
 6 dspportcnts
 7 dspportcnt
 8 dspportcnt 1
 9 dsplmistats
10 cmdhistory

spirit4.1.8.PXM.a >
```

cnfaimgrp

Use the **cnfaimgrp** command to configure an AIMUX group on the AUSM.

Full Name

Configure AIM Group

Card(s) on Which This Command Executes

AUSM

Syntax

cnfaimgrp <grp> <max_diff_delay> <min_num_links>

Syntax Description

<i>grp</i>	IMA group number, in the range 1–8.
<i>max_diff_delay</i>	Maximum differential delay, in the range appropriate for the interface. <ul style="list-style-type: none"> • 8T1 range = 0–275 • 8E1 range = 0–200
<i>min_num_links</i>	Minimum number of links for the group formation, in the range 1–8.

Related Commands

addaimgrp, delaimgrp, dspaimgrp, dspaimgrps

Attributes

Log: Yes State: Active Privilege: 1–2

Note Redundant link(s) indicates the number of link(s) the system can lose without bringing down the AIMUX group. However, the <link_loss_severity> option overrides this feature.

The <read_wr_ptr_diff> value cannot be decreased from its existing value—it can only be increased (this is because decreasing the <read_wr_ptr_diff> in an established AIMUX group involves dropping cells that are stored in the delay compensation buffer).

Example 1-70 Configure AIMUX group 1 on the AUSM card in slot 17 to have a read/write pointer differential of 5, a link loss severity of 2, a maximum tolerable differential delay of 5, and 2 redundant links

```
flyers01.1.17.AUSM.a > cnfaimgrp 1 -rwdiff 5 -severity 2 -maxdiff 3 -red 2
flyers01.1.17.AUSM.a >
```

cnfapsln

Use the **cnfapsln** command to set Automatic Protection Switching (APS) parameters for a line on the current PXM. APS is a standard that provides a means for SONET line redundancy. APS involves switching between working (active) and protection (standby) SONET lines in the event of a hardware failure detected by the receiving end or by the far-end. *This support only applies to PXM OC3 and PXM OC12 back cards.*

The 1.1.20 software release provides support for the SONET Linear APS 1+1 mode with two backcards. The SONET Linear APS 1+1 standard specifies that for every working line there must exist a redundant protection line. Traffic protected by the redundant line is carried simultaneously on both the working line and the protection line. The line switch over to the protection line has to be completed within 60ms.

Figure 1-3 illustrates a “Dual Backcard” redundancy configuration. This design requires two PXM front cards and two SONET backcards. Ports are paired as follows:

- Port 1 of active PXM and port 1 of standby PXM.

Figure 1-3 SONET APS 1+1 with Two BACKCARDS

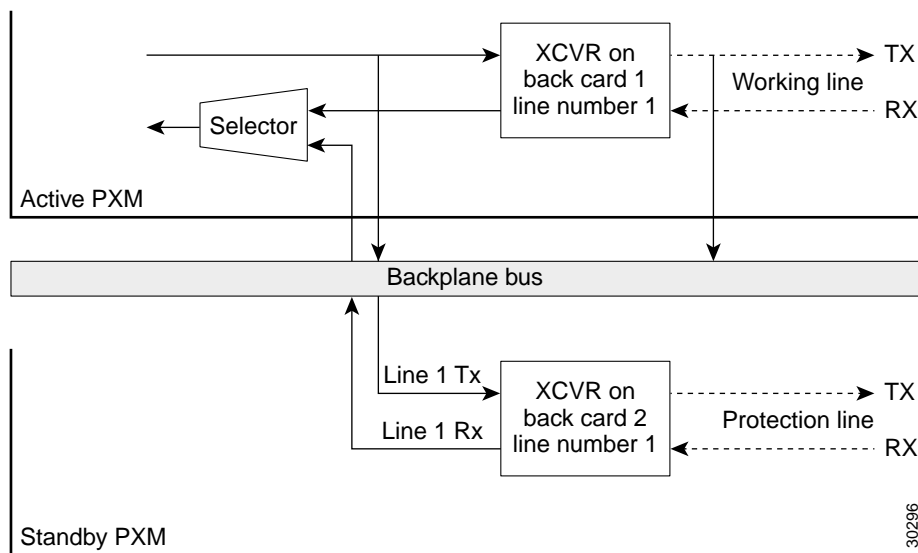

SONET 155 also can be configured to have this redundancy configuration. Ports are paired as follows:

- Port 1 of active PXM and port 1 of standby PXM
- Port 2 of active PXM and port 2 of standby PXM
- Port 3 of active PXM and port 3 of standby PXM
- Port 4 of active PXM and port 4 of standby PXM

Switching of the paired port on the pair backcard can be done independently of the other paired ports.

You must add an APS line with the **addapsln** command before using the **cnfapsln** command.

Full Name

Configure APS Line

Card(s) on Which This Command Executes

PXM

Syntax

```
cnfapsln <workline> <SFBER> <SDBER> <WTR> <Direction> <Revertive> <K1K2>
```

Syntax Description

<i>workline</i>	OC-3 or OC-12 line number, in the range appropriate for the associated interface. <ul style="list-style-type: none"> • OC-3 range = 1–4 • OC-12 = enter the value 1
<i>SFBER</i>	Signal failure BER threshold, in the range 3–5. <ul style="list-style-type: none"> • 5 = signal failure BER threshold = 10^{-5}
<i>SDBER</i>	Signal degrade BER threshold, in the range 5–9. <ul style="list-style-type: none"> • 5 = signal degrade BER threshold = 10^{-5}
<i>WTR</i>	Number of minutes to wait before attempting to switch back to the working line, in the range 1 to 12. This setting is not applicable if the line is configured in non-revertive mode (<i>Revertive</i> set to 1).
<i>Direction</i>	Value to set the switching direction for either unidirectional or bidirectional. <ul style="list-style-type: none"> • 1 = Unidirectional: This APS line supports only one direction • 2 = Bidirectional: This APS line supports both ends of the line
<i>Revertive</i>	Value to set the APS revertive or non-revertive function. <ul style="list-style-type: none"> • 1 = Non-revertive • 2 = Revertive This setting allows the line to switch back to the working line after the wait-to-restore interval has expired and the working line SF/SD has been cleared.
<i>K1K2</i>	To to enable or disable the K1/K2 inband interface on the protection line. User should always set to 1. <ul style="list-style-type: none"> • 1 = enable • 2 = disable

Related Commands

addapsln, delapsln, dspapsln, dspapscfg

Attributes

Log: Yes State: Active Privilege: SuperUser

Example 1-71 **Configure the APS working line 1 on the active PXM card in slot 7 to have a signal failure BER threshold of 10⁵, a signal degrade BER threshold of 10⁵, to enable switch back after signal failure or degradation has cleared, to wait 2 minutes before attempting to switch back, to make switching bidirectional, and to enable the K1/K2 inband interface on the protection line**

```
flyers01.1.7.PXM.a > cnfapsln 1 5 5 1 2 1 1  
flyers01.1.7.PXM.a >
```

cnfatmln

Use the **cnfatmln** command to configure a UNI or NNI cell header for a PXM trunk. UNI cell headers are typically used on the line that connects to a workstation rather than a switch.

Note You must configure the cell header type using the **cnfatmln** command before adding lines and ports.

Full Name

Configure ATM Line

Card(s) on Which This Command Executes

PXM (in an MGX 8800 series stand-alone node)

Syntax

cnfatmln <line_num> <type>

Syntax Description

line_num OC-3 or OC-12 line number, in the range appropriate for the interface.

- OC-3 range = 1–4
- OC-12 = enter the value 1

type Value to set cell header type for either UNI or NNI.

- 2 = UNI
- 3 = NNI (default)

Related Commands

dspatmlncnf, clratmlncnt

Attributes

Log: No

State: Any

Privilege: Any

Example 1-72 Set the cell header type for trunk 1 on the PXM to NNI

```
flyers01.1.7.PXM.a > cnfatmln 1 3
flyers01.1.7.PXM.a >
```

cnfbctype

Use the **cnfbctype** command to specify the interface of the 12in1 dual-personality back card. The back card can be configured with either an X.21 or a V.35 interface. The default interface is V.35.

Note The **cnfbctype** is not allowed if there are enabled lines on the card.

Full Name

Configure Back Card Type

Card(s) on Which This Command Executes

FRSM-HS1B

Syntax

cnfbctype <cardType>

Syntax Description

cardType An integer that specifies the interface type:

- 1 = X.21
- 2 = V.35

Default = V.35.

Related Commands

dspbctype

Attributes

Log: Yes State: Any Privilege: Service Group (-1)

Example 1-73 Configuring the interface type on the current FRSM card

```
man.1.14.FRSM.a > cnfbctype 1
```

Example 1-74 Displaying the interface type on the current FRSM

```
man.1.14.FRSM.a > dspbctype
```

```
Backcard Personality: X.21
```

cnfbert

Use the **cnfbert** command to configure BERT testing parameters on the PXM.

A BERT session does not time out automatically. Use the **delbert** command to end the test.



Warning BERT is a disruptive test. Activation of this test will stop the data flow on all the channels configured on the port under test. BERT testing requires the presence of an SRM-3T3/B card in the service bay, in which the card under test is located.

Full Name

Configure BERT

Card(s) on Which This Command Executes

PXM

Syntax: PXM

cnfbert <*slot*>

Syntax Description

slot Slot number that contains the card on which to perform BERT testing.

Related Commands

delbert, dspbert, modbert, xcfnbert

Attributes

Log: Yes State: Active Privilege: Group 1

cnfcbclk

Use the **cnfcbclk** command to set the cell bus (CB) operating clock rate to high (42 MHz) or low (21 MHz). There are 8 cell buses in a MGX 8800 series shelf. You can use the **cnfcbclk** command to set the cell bus to different operating clock rates to take advantage of high-speed service modules whenever possible. Note that not all service modules can support the high clock rate.

Note Even though you can specify this command against CB4 and CB8, note that the clock rate will not change for either cell bus.

Full Name

Configure Cell Bus Clock

Card(s) on Which This Command Executes

FRSM_2CT3, FRSM_2T3, FRSM_2E3, FRSM_HS2, CESM_T3, CESM_E3, VISM_8T1, VISM_8E1, RPM (new), PXM

Syntax

cnfcbclk <cellBus> <clockRate>

Syntax Description

- | | |
|------------------|---|
| <i>cellBus</i> | A string denoting a bus, in the range CB1 to CB8. Even though you can specify this command against CB4 and CB8, note that the clock rate will not change for either cell bus. |
| <i>clockRate</i> | A rate value, in MHz. <ul style="list-style-type: none">• 21• 42 |

Possible Errors

- Set failed due to illegal option value(s).
- Certain Service Modules will not operate at the clock rate you specified. Please check the service modules in the slots where the cell bus clock rate is affected by this command.

Related Commands

dspcbclk

Attributes

Log: Yes State: Active Privilege: Super Group

Example 1-75 Display the cards in the chassis, display the current clock settings, configure CB2 for 42 MHz, and display clock settings with the new setting for CB2

NODENAME12.1.7.PXM.a > **dspcds**

Command Executed :dspcds

Slot	CardState	CardType	CardAlarm	Redundancy
1.1	Empty		Clear	
1.2	Active	FRSM-8T1	Clear	
1.3	Empty		Clear	
1.4	Empty		Clear	
1.5	Empty		Clear	
1.6	Active	FRSM-8T1	Clear	
1.7	Active	PXM1-OC3	Clear	
1.8	Empty		Clear	
1.9	Empty		Clear	
1.10	Empty		Clear	
1.11	Empty		Clear	
1.12	Empty		Clear	
1.13	Empty		Clear	
1.14	Empty		Clear	
1.15	Empty		Clear	
1.16	Empty		Clear	
1.17	Empty		Clear	
1.18	Empty		Clear	
1.19	Empty		Clear	

Type <CR> to continue, Q<CR> to stop: q

NODENAME12.1.7.PXM.a > **dspcbclk**

Command Executed :dspcbclk

CellBus	Rate (MHz)	Slot
CB1	21	1, 2
CB2	21	3, 4
CB3	21	5, 6
CB4	21	17 - 22
CB5	21	9, 10
CB6	21	11, 12
CB7	21	13, 14
CB8	21	25 - 30

NODENAME12.1.7.PXM.a > **cnfcbclk cb2 42**

Command Executed :cnfcbclk

NODENAME12.1.7.PXM.a > **dspcbclk**

Command Executed :dspcbclk

CellBus	Rate (MHz)	Slot
CB1	21	1, 2
CB2	42	3, 4
CB3	21	5, 6
CB4	21	17 - 22
CB5	21	9, 10
CB6	21	11, 12
CB7	21	13, 14
CB8	21	25 - 30

Example 1-76 Error messages that may be displayed when executing this command

```
popeye12.1.7.PXM.a > cnfcbclk cb1 42  
Command Executed :cnfcbclk  
Set failed due to illegal option value(s)  
  
Syntax: cnfcbclk <cellBus> <clockRate>  
      cellBus -- a string CB1..CB8  
      clockRate -- a number 21 or 42 (MHz)  
  
WARNING: Certain Service Modules will not operate at the clock rate you  
specified. Please check the Service Modules in the slots where the Cell Bus clock  
rate is effected by this command
```

cnfcdprtntype

Use the **cnfcdprtntype** command to configure the type of partition to serve as the basis for sharing GLCNs. The GLCNs are shared by the network controller applications (PAR, for example) on a logical broadband interface.

Full Name

Configure Card Resource Type

Card(s) on Which This Command Executes

PXM, FRSM, AUSM, CESH

Syntax

cnfcdprtntype <prtntype>

Syntax Description

<i>prtntype</i>	Value to set card partition type, in the range 1–3. <ul style="list-style-type: none">• 1 = <i>noPartition</i> All controllers compete for the total number of (G)LCNs available for the card.• 2 = <i>controllerBased</i> The total number of (G)LCNs available to each controller is fixed but there is no reservation on each port.• 3 = <i>portControllerBased</i> Some of the (G)LCNs that are available on each port for each controller are reserved.
-----------------	--

Related Commands

cnfrsprt, cnfcdrsprtn, dspcdrsctype

Attributes

Log: No

State: Any

Privilege: Any (Service_GP)

Example 1-77 Allow all controllers access to all the (G)LCNs available for the card

```
spirit3.1.10.AUSMB8.a > cnfcdprtntype 1
spirit3.1.10.AUSMB8.a >
```

cnfcdrsprtn

Use the **cnfcdrsprtn** command to modify card-level resource partitions on the current card. This command creates a template of available connections among the network controllers, to provide card-level partitioning for PAR, PNNI or Tag. With card-level partitioning:

- The number of connections available at each port is the same.
- You can specify the number of connections available to each controller or let them compete for connections at each port.

The matrix in Table 1-5 describes the effects of each of three usages of **cnfcdrsprtn**.

Table 1-5 Degrees of Card-Level Resource Partitioning

Command	Description
cnfcdrsprtn off	Card-level partitioning is inactive. If you specify that card-level partitioning is off (cnfcdrsprtn off), you must configure port-level partitions (cnfportrsprtn).
cnfcdrsprtn on	Default Card-level partitioning is on, but no allocation for a specific controller is specified. The maximum number of connections on a port is available to each controller, so each controller competes for the connections.
cnfcdrsprtn on <x> <y> <z>	The x, y, and z represent a number of connections per port available to the PAR, PNNI, and Tag controllers, respectively.

Note PNNI is always 0 in Release 1 of an MGX 8800 series switch.

Additional characteristics of this command are

- If you do not execute **cnfcdrsprtn**, the default state of **cnfcdrsprtn on** is in effect.
- If you specify card-level partitioning (**cnfcdrsprtn on x y z**), port-level partitioning (**cnfportrsprtn**) is an option you can use to further modify the partitioning on a port.

Full Name

Configure Card Resource Partition

Card(s) on Which This Command Executes

PXM, FRSM, AUSM, CESM, VISM

Syntax

cnfcdrsprtn <PAR_max_conns> <PNNI_max_conns> <Tag_max_conns>

Syntax Description

PAR_max_conns Maximum number of PAR connections, in the range appropriate for the current card.

- PXM range = 0–32,767 GLCNs
- FRSM range = 1–4000
- AUSM range = 1–1000
- CESM range = 1–1000
- SRM range = 1–1000

PNNI_max_conns Maximum number of PNNI connections. Enter the value 0 (zero).

Tag_max_conns Maximum number of TAG connections.

Related Commands

addcdrsprtn, delcdrsprtn, dspcdrsprtn, dspcdrsctype

Attributes

Log: Yes State: Any (Active for PXM) Privilege: Any

Example 1-78 On the current PXM, change the card-level partitioning to give 10000 GLCNs to PAR and 10000 GLCNs to Tag. Note that the value for PNNI currently is 0

```
spirit.1.7.PXM.a > cnfcdrsprtn 10000 0 10000
spirit.1.7.PXM.a >
```

cnfchan

Use the **cnfchan** command to configure channels on the current service card.

Full Name

Configure Channel

Card(s) on Which the Command Executes

PXM, AUSM, CESM

Syntax: PXM

cnfchan <LCN> <chan_rte_pri> <chan_max_cost> <chan_restrict_trk_type>

Syntax Description

<i>LCN</i>	LCN, in the range 16–4111.
<i>chan_rte_pri</i>	Channel route priority, in the range 1–15.
<i>max_cost</i>	Maximum cost, in the range 1–255.
<i>chan_restrict_trk_type</i>	Value to set Channel Restrict Trunk Type <ul style="list-style-type: none"> • 1 = No Restriction • 2 = Terrestrial Trunk • 3 = Satellite Trunk

Syntax: AUSM-8T1E1

cnfchan <chan_num> <RoutingPriority> <MaxCost> <RestrictTrunkType> <PCR> <MCR> <PctUtil>

Syntax Description

<i>chan_num</i>	Channel number, in the range 16–1015.
<i>RoutingPriority</i>	Routing Priority, in the range 1–15.
<i>MaxCost</i>	Maximum cost, in the range 1–255.
<i>RestrictTrunk Type</i>	Value to set Restrict Trunk Type. <ul style="list-style-type: none"> • 1 = No Restriction • 2 = Terrestrial Trunk • 3 = Satellite Trunk
<i>pcr</i>	Peak cell rate, in the range 1–65525 cells/second.
<i>mcr</i>	Minimum cell rate, in the range 1–65525 cells/second.
<i>PctUtil</i>	Percentage of utilization, in the range 1–100.

Syntax: CESM-8T1E1

cnfchan <chan_num> <CDVT> <CLIP> <bufsize> <clockmode> <ISenable> <ForceIS>

Syntax Description

<i>chan_num</i>	Channel number (LCN). Enter the value 32.
<i>CDVT</i>	Cell Delay Variation Tolerance in the range appropriate for T1 or E1. <ul style="list-style-type: none"> • T1 = 125–24000 microseconds • E1 = 125–32000 microseconds
<i>CLIP</i>	Cell Loss Integration Period. Enter a value in the range 1000–65535 milliseconds.
<i>bufsize</i>	Maximum Egress Buffer size, as appropriate for T1 or E1. <ul style="list-style-type: none"> • Structured T1 = 9216 bytes (maximum) • Unstructured T1 or E1 = 16384 bytes (maximum)
<i>clock mode</i>	Value to set clock mode of the CBR virtual circuit. <ul style="list-style-type: none"> • 1 = synchronous clocking • 2 = Synchronous Residual Time Stamp clocking • 3 = Adaptive clocking
<i>ISenable</i>	Value to enable or disable idle suppression. <ul style="list-style-type: none"> • 1 = disable • 2 = enable
<i>ForceIS</i>	Value to set forced idle suppression or normal operations. <ul style="list-style-type: none"> • 1 = normal operation • 2 = force Virtual Circuit into Idle signal code suppression

Syntax: CESM-T3E3

cnfchan <chan_num> <CDVT> <CLIP> <bufsize>

Syntax Description

<i>chan_num</i>	Channel number (LCN). Enter the value 32.
<i>CDVT</i>	Cell Delay Variation Tolerance, in the range appropriate for T3 or E3. <ul style="list-style-type: none"> • T3 range = 125–24000 microseconds • E3 range = 125–32000 microseconds
<i>CLIP</i>	Cell Loss Integration Period, in the range 1000–65535 milliseconds.
<i>bufsize</i>	Maximum Egress Buffer size, in bytes. Set up to the maximum 16384 for unstructured T3 or E3.

Related Commands

addchan

Attributes

Log: No State: Any Privilege: Any

Example 1-79 On the current AUSM in slot 17, change the configuration for channel 16 to set a routing priority of 1, a maximum cost of 5, restrict trunk routing for this channel to terrestrial trunks only, set the peak cell rate to 655525 cells per second, set the minimum cell rate to 655525 cells per second, and set the percent utilization to 100 percent

```
spirit.1.17.AUSM.a > cnfchan 16 1 5 2 65525 65525 100  
spirit.1.17.AUSM.a >
```

cnfchaneir

Use the **cnfchaneir** command to configure the frame relay policing parameter “excess information rate” (EIR), which is the second bucket leak rate for a channel. No messages appear on the screen unless an error occurs.

Available

Release 1.1.21 and higher

Full Name

Configure channel EIR

Card(s) on Which the Command Executes

FRSM-8T1/E1, FRSM-VHS

Syntax: PXM

cnfchaneir <chan_num> <zerocireir>

Syntax Description

<i>chan_num</i>	Specifies the channel for which you are modifying the policing parameter. Values are: <ul style="list-style-type: none">• For FRSM-8T1/E1, 16–1015• For FRSM-2CT3, 16–4015• For FRSM-2T3/E3 and FRSM-HS2, 16–2015
<i>zerocireir</i>	Specifies the excess information rate for 0 CIR cases. Values are: <ul style="list-style-type: none">• For FRSM-8T1, 0–1536000 bps• For FRSM-8E1, 0–2048000 bps• For FRSM-2CT3, 0–1536000 bps• For FRSM-2T3, 0–44210000 bps• For FSM-2E3, 0–34010000 bps• For FRSM-HS2 0–51840000 bps

Related Commands

dspchan

Attributes

Log: Yes State: Active Privilege: 1-2

cnfchancacoff

Use the **cnfchancacoff** command to turn off the connection admission control (CAC) function for a channel.

Full Name

Configure Channel CAC Off

Card(s) on Which This Command Executes

FRSM

Syntax

cnfchancacoff <chan_num>

Syntax Description

chan_num Channel number, in the range appropriate for the interface type.

- 8T1/E1 range = 16–1015
- HS1/B range = 16–1015
- T3/E3/HS2 range = 16–2015
- 2CT3 range = 16–4015

Related Commands

None

Attributes

Log: Yes State: Active Privilege: 1–2

Example 1-80 On the current FRSM in slot 27, change the configuration for channel 16 to turn off the connection admission control (CAC) function

```
spirit.1.27.FRSM.a > cnfchancacoff 16
spirit.1.27.FRSM.a >
```

cnfchanegressq

Use the **cnfchanegressq** command to configure the egress queue for a specified channel.

Full Name

Configure Channel Egress Queue

Card(s) on Which This Command Executes

FRSM

Syntax

cnfchanegressq <chan_num> <Qsel> <Qdepth> <QDEThresh> <QECNThresh>

Syntax Description

<i>chan_num</i>	Channel number, in the range appropriate for the interface type. <ul style="list-style-type: none"> • 8T1/E1 range = 16–1015 • T3/E3/HS2 range = 16–2015 • 2CT3 range = 16–4015
<i>Qsel</i>	Value to set Egress queue select. <ul style="list-style-type: none"> • 1 = High priority queue, usually used for CBR (Committed Bit Rate) connections. • 2 = Low priority queue (default). • 3 = Not used. This option only for the FRSM-T3/E3/HS2 and FRSM-2CT3 service modules. For these service modules, the queue to which the channel gets mapped is determined by the channel service type.
<i>Qdepth</i>	Egress queue depth, in the range 1–65535 bytes. This setting is the maximum allowable depth for the queue before it starts dropping cells. Default = 65535 bytes
<i>QDEThresh</i>	Egress queue DE Threshold, in the range 1–65535 bytes. This setting is the maximum depth for the queue before the cells are tagged as discard eligible (DE). Default = 32767 bytes
<i>QECNThresh</i>	Egress queue ECN Threshold, in the range 1–65535 bytes. This setting is the maximum depth for the queue before initiating flow control. Default = 65535 bytes

Related Commands

cnfchaningressq

Attributes

Log: Yes State: Active Privilege: 1-2

Example 1-81 **On the current FRSM in slot 27, change the configuration of the egress queue for channel 16 to set the priority to high, set the maximum queue depth to 65535, the Discard Eligible threshold to 32767, and the ECN threshold to 65535**

```
spirit.1.27.FRSM.a > cnfchanegressq 16 1 65535 32767 65535
spirit.1.27.FRSM.a >
```

cnfchanfst

Use the **cnfchanfst** command to configure ForeSight parameters for a Frame Relay or ATM channel.

Full Name

Configure Channel ForeSight

Card(s) on Which This Command Executes

FRSM, AUSM

Syntax: FRSM

cnfchanfst <chan_num> <fst_enable> <mir> <pir> <qir>

Syntax Description

<i>chan_num</i>	Channel number, in the range appropriate for the FRSM card type. <ul style="list-style-type: none"> • 8T1/E1 range = 16–1015 • T3/E3/HS2 range = 16–2015 • 2CT3 range = 16–4015
<i>fst_enable</i>	Value to enable or disable ForeSight. <ul style="list-style-type: none"> • 1 = enable • 2 = disable
<i>mir</i>	Minimum information rate, as appropriate for the FRSM card type. <ul style="list-style-type: none"> • 8T1/E1 the range = 10–8000 in cell/sec. • T3/E3/HS2/2CT3 range = 10–400000 in cell/sec. Default = 1000
<i>pir</i>	Peak information rate, as appropriate for the FRSM card type. <ul style="list-style-type: none"> • 8T1/E1 range = 10–8000 in cell/sec. • T3/E3/HS2/2CT3, the range is 10–400000 in cell/sec. Default = 1000
<i>qir</i>	Quiescent information rate, as appropriate for the FRSM card type. <ul style="list-style-type: none"> • 8T1/E1 range = 0–8000 in cell/sec. • T3/E3/HS2/2CT3 range = 10–400000 in cell/sec. Default = 1000

Syntax: AUSM

cnfchanfst <port.VPI.VCI | channel number> <enable | disable> <fgcra_enable> <ibs> <pcr> <mcr> <icr>

Syntax Description

<i>port.VPI.VCI</i>	Connection identifier, in the format <i>port.VPI.VCI</i> . <ul style="list-style-type: none"> Port range = 1–<i>n</i>, as appropriate for the physical installation <i>vpi</i> range = 1–4095 <i>vci</i> range = 1–65535
channel number	Channel number, in the range 16–1015.
<i>enable disable</i>	Value to enable or disable ForeSight: <ul style="list-style-type: none"> 1 = disable 2 = enable
<i>fgcra_enable</i>	Value to enable or disable FGCRA for the specified channel. <ul style="list-style-type: none"> 1 = disable 2 = enable
<i>ibs</i>	Initial burst size, in the range 0–5000 cells.
<i>pcr</i>	Peak cell rate, in the range 10–38328 cells/second. <ul style="list-style-type: none"> 10-PortRate (T1-3622, E1-4528, clearE1-4830) IMA, T1-3591, E1-4490, clrE1-4789 <p>Note that the IMA port's speed is variable and depends on the number of links in the port. Multiply the rate by the number of links.</p>
<i>mcr</i>	Minimum cell rate, in the range 10–38328 cells/second. <ul style="list-style-type: none"> 0-PortRate(T1-3622, E1-4528, clearE1-4830) For IMA, T1-3591, E1-4490, clrE1-4789 <p>Note that the IMA port's speed is variable and depends on the number of links in the port. Multiply the rate by the number of links.</p>
<i>icr</i>	Initial cell rate, in the range 10–38328 cells/second. <ul style="list-style-type: none"> 0-PortRate (T1-3622, E1-4528, clearE1-4830) For IMA, T1-3591, E1-4490, clrE1-4789 <p>Note that the IMA port's speed is variable and depends on the number of links in the port. Multiply the rate by the number of links.</p>

Related Commands

dspchan

Attributes

Log: Yes State: Active Privilege: 1–2

Example 1-82 On the current FRSM in slot 27, change the configuration of the ForeSight for channel 16 to enable ForeSight, to set the minimum information rate to 1000 cells per second, to set the peak information rate to 1000 cells per second, and to set the quiescent information rate to 1000 cells per second

```
spirit.1.27.FRSM.a > cnfchanfst 16 1 1000 1000 1000
spirit.1.27.FRSM.a >
```

A system response does not occur unless an error is detected.

Example 1-83 On the current AUSM in slot 12, changing the configuration using the port.VPI.VCI argument

```
s1.1.12.AUSM8.a > cnfchanfst 2.1.5 2 1 2000 4000 2000 2000
s1.1.12.AUSM8.a >
```

Example 1-84 On the current AUSM in slot 12, changing the configuration using the channel number argument

```
s1.1.12.AUSM8.a > cnfchanfst 31 2 1 2000 4000 2000 2000
s1.1.12.AUSM8.a >
```

Note This command is valid only for ABR-type channels.

cnfchaningressq

Use the **cnfchaningressq** command to configure the Ingress queue for a specified channel.

Full Name

Configure Channel Ingress Queue

Card(s) on Which This Command Executes

FRSM

Syntax

cnfchaningressq <chan_num> <Qsel> <Qdepth> <QDEThresh> <QECNThresh>

Syntax Description

<i>chan_num</i>	Channel number, in the range appropriate for the FRSM card type. <ul style="list-style-type: none"> • 8T1/E1 range = 16–1015 • HS1/B range = 16–1015 • T3/E3/HS2 range = 16–2015 • 2CT3 range = 16–4015
<i>Qsel</i>	FRSM-8T1/E1 only. Value to set Egress queue select. <ul style="list-style-type: none"> • 1 = High priority queue, usually used for Committed Bit Rate (CBR) connections. • 2 = Low priority queue (default). • 3 = Not used. This option only for the FRSM-T3/E3/HS2 and FRSM-2CT3 service modules. For these service modules, the queue to which the channel gets mapped is determined by the channel service type.
<i>Qdepth</i>	Ingress queue depth, in the range 1–65535 bytes. This setting is the maximum depth for the queue before it starts dropping cells. Default = 65535 bytes
<i>QDEThresh</i>	Ingress queue DE Threshold, in the range 1–65535 bytes. This setting is the maximum depth for the queue before the cells are tagged as discard eligible (DE). Default = 32767 bytes
<i>QECNThresh</i>	Ingress queue ECN Threshold, in the range 1–65535 bytes. This setting is the maximum depth for the queue before initiating flow control. Default value = 65535 bytes

Related Commands

cnfchanegressq

Attributes

Log: Yes State: Active Privilege: 1-2

Example 1-85 On the current FRSM in slot 27, change the configuration of the egress queue for channel 16 to set the priority to high, set the maximum queue depth to 65535, the Discard Eligible threshold to 32767, and the ECN threshold to 65535

```
spirit.1.27.FRSM.a > cnfchaningressq 16 1 65535 32767 65535  
spirit.1.27.FRSM.a >
```

cnfchanmap

Use the **cnfchanmap** command to configure interworking field mapping for a specified channel.

Full Name

Configure Channel Map

Card(s) on Which This Command Executes

FRSM

Syntax

cnfchanmap *<chan_num>* *<chanType>* *<FECN/EFCI>* *<DE to CLP>* *<CLP to DE>*

Syntax Description

<i>chan_num</i>	Channel number, in the range appropriate for the FRSM card type. <ul style="list-style-type: none"> • 8T1/E1 range = 16–1015 • HS1/B range = 16-1015 • T3/E3/HS2 range = 16–2015 • 2CT3 range = 16–4015
<i>chanType</i>	Value to set channel type. <ul style="list-style-type: none"> • 1 = network interworking • 2 = service interworking in transparent mode • 3 = service interworking in translation mode • 4 = FUNI • 5 = frame forwarding
<i>FECN/EFCI</i>	Value to set mapping between FECN and EFCI. <ul style="list-style-type: none"> • 1 = map EFCI (this option valid only for service interworking) • 2 = make EFCI 0
<i>DE to CLP</i>	Value to set DE to CLP mapping. <ul style="list-style-type: none"> • 1 = map DE to CLP • 2 = make CLP 0 • 3 = make CLP 1
<i>CLP to DE</i>	Value to set CLP to DE mapping. <ul style="list-style-type: none"> • 1 = map CLP to DE • 2 = make DE 0 • 3 = make DE 1 • 4 = ignore CLP (this option valid only for network interworking)

Related Commands

dspchanmap

Attributes

Log: Yes State: Active Privilege: 1–2

Example 1-86 On the current FRSM in slot 27, change the configuration of the interworking channel mapping for channel 16 to set the channel type to network interworking, to set EFCI equal to 0, to set the DE to CLP mapping to map DE to CLP, and to set the CLP to DE mapping to map CLP to DE

```
spirit.1.27.FRSM.a > cnfchanmap 16 1 1 1
spirit.1.27.FRSM.a >
```

cnfchanpol

Use the **cnfchanpol** command to configure the Frame Relay policing parameters for a channel. No messages appear on screen unless an error occurs.

Full Name

Configure Channel Policing

Card(s) on Which This Command Executes

FRSM

Syntax

cnfchanpol <chan_num> <cir> <bc> <be> <ibs> <detag>

Syntax Description

- chan_num* Channel number, in the range appropriate for the FRSM card type.
- 8T1/E1 range = 16–1015
 - HS1/B range = 16–1025
 - T3/E3/HS2 range = 16–2015
 - 2CT3 range = 16–4015
- cir* Committed Information Rate, in the range appropriate for the interface.
- T1 range = 0–1536000 bps
 - E1 range = 0–2048000 bps
 - T3 range = 0–44210000 bps
 - E3 range = 0–34010000 bps
 - HSSI range = 0–51840000 bps
- Default = 2400 bits per second (bps)
- Note that for the FRSM-2CT3 service module, the peak value for permissible CIR is 1536000 bits per second.
- bc* Burst Committed rate, in the range appropriate for the FRSM card type.
- FRSM-8T1/E1 range = 0–65535 bytes
 - FRSM-T3/E3/HS2 range = 0–2097151 bytes
 - FRSM-2CT3 range = 0–2097151 bytes
- Default = 5100 bytes.
- Note that the Burst Committed value cannot be 0 when the Committed Information Rate is not 0.
 - The Burst Committed value **MUST** be set to 0 when the Committed Information Rate is set to 0.
- be* Burst Excess rate, in the range appropriate for the FRSM card type.
- FRSM-8T1/E1 range = 0–65535 bytes
 - FRSM-T3/E3/HS2 range = 0–2097151 bytes
 - FRSM-2CT3 = 0–2097151 bytes
- Default = 5100 bytes
- Note that the Burst Excess value cannot be 0 when the Committed Information Rate is set to 0.

- ibs* Initial Burst Size, the range appropriate for the FRSM card type.
- FRSM-8T1/E1 range = 0–65535 bytes
 - FRSM-T3/E3/HS2 range = 0–2097151 bytes
 - FRSM-2CT3 range = 0–2097151 bytes
- Default =100 bytes
- Note that the Initial Burst Size should be less than or equal to the value of Burst Committed when the Committed Information Rate is set to greater than 0.
 - When the Committed Information Rate is set to 0, the Initial Burst Size MUST be set to 0.
- detag* Value to enable or disable ingress Discard Eligible (DE) tagging.
- 1 = enable
 - 2 = disable (default)

Related Commands

dspchan

Attributes

Log: Yes State: Active Privilege: 1–2

Example 1-87 On the current FRSM in slot 27, change the configuration of the ForeSight for channel 16 to enable ForeSight, to set the committed information rate to 100000 cells per second, to set the committed burst size to 65535 bytes, to set the burst excess to 65535 bytes, to set the initial burst size to 1000 bytes, and to enable Discard Eligible tagging

```
spirit.1.27.FRSM.a > cnfchanpol 16 1 100000 65535 65535 1000 1
spirit.1.27.FRSM.a >
```

cnfchanq

Use the **cnfchanq** command configure queue parameters for a specified channel on the current PXM or AUSM.

Full Name

Configure Channel Queue

Card(s) on Which This Command Executes

PXM, AUSM

Syntax: PXM

cnfchanq <LCN> <discard_option> <clp_thresh_high> <clp_thresh_low> <efci_thresh>

Syntax Description

<i>LCN</i>	Channel number, in the range 16–4111.
<i>discard_option</i>	Value to set discard option for hysteresis or frame discard. <ul style="list-style-type: none"> • 1 = CLP Hysteresis • 2 = Frame Discard
<i>clp_thresh_high</i>	CLP Threshold High, in the range 1–491520 cells. Once the High Cell Loss Priority threshold is exceeded cells can have a CLP bit set, making them discard eligible.
<i>clp_thresh_low</i>	CLP Threshold Low, in the range 1–491520 cells. Once the low Cell Loss Priority threshold is passed cells will no longer have the CLP bit set, making them discard eligible.
<i>efci_thresh</i>	EFCI Threshold, in the range 1–491520 cells. An Explicit Forward Congestion Indicator is sent to the sending node when the threshold is exceeded.
<i>Congestion Update</i>	Value to set congestion update. <ul style="list-style-type: none"> • 1 = Don't Update • 2 = Set CI Bit • 3 = Set EFCI Bit • 4 = Clear EFCI
<i>Max Cell Count</i>	Maximum cell count, in the range 0–512000 cells.

Syntax: AUSM

cnfchanq <chan_num> <vc_q_depth> <clp_thresh_high> <clp_thresh_low> <efci_thresh>

Syntax Description

<i>chan_num</i>	Channel number, in the range 16–1015.
<i>vc_q_depth</i>	Ingress Queue Depth, in the range 0–16000 cells.
<i>clp_thresh_high</i>	CLP Threshold High, in the range 1–16000 cells. Once the High Cell Loss Priority threshold is exceeded, cells can have a CLP bit set, making them discard eligible.
<i>clp_thresh_low</i>	CLP Threshold Low, in the range 1–16000 cells. Once the low Cell Loss Priority threshold is exceeded, cells will no longer have the CLP bit set, making them discard eligible.
<i>efci_thresh</i>	EFCI Threshold, in the range 1–16000 cells. An Explicit Forward Congestion Indicator is sent to the sending node when the threshold is exceeded.

Related Commands

dspchan

Attributes

Log: Yes State: Active Privilege: 1–2 on AUSM, Any on PXM

Example 1-88 On the current AUSM in slot 1, change the configuration of the channel queue for channel 16 to set the ingress queue depth to 16000, the CLP High threshold to 16000, the CLP Low threshold to 10000, and the EFCI threshold to 12000

```
spirit.1.1.AUSM.a > cnfchanq 16 16000 16000 10000 12000
spirit.1.1.AUSM.a >
```

cnfchansrvrate

Use the **cnfchansrvrate** command to provision the service rate of a channel independent of the CIR rate of the connection. This feature separates the policing parameters (CIR, BC, BE, IBS) from the service rate, providing you with more traffic management control over the connection.

Full Name

Configure Channel Service Rate

Card(s) on Which This Command Executes

FRSM 2T3/E3, FRSM HS2, FRSM-8

Syntax

cnfchansrvrate <LCN> <ena | dis> <srvrate>

Syntax Description

<i>LCN</i>	Channel number, in the range: <ul style="list-style-type: none"> • FRSM-8T1/E1, FRSM-HS1, 16–1015 • FRSM-HS2, 2T3, 2E3, 16–2015 • FRSM-2CT3, 16–4015
<ena dis>	A numeric value. <ul style="list-style-type: none"> • 1 = enable • 2 = disable
<i>srvrate</i>	The actual service rate to be provisioned for the given channel (in CPS). <ul style="list-style-type: none"> • For VHS modules, the maximum rate is 285714 CPS

Related Commands

cnfchanfst

Attributes

Log: Yes State: Any state Privilege: Any

Example 1-89 Configure the SAR on the current FRSM, service connection 16, at 4000 cells per second, even though the CIR for the connection may be set to 0

```
NODENAME.1.26.VHS2CT3.a > cnfchansrvrate 16 1 4000
NODENAME.1.26.VHS2CT3.a >
```

cnfclksrc

Use the **cnfclksrc** command to configure an interface as a clock source. Available clock sources are shown in Table 1-6. Any combination of clock sources are configurable in any order (primary or secondary). For example, you can configure an external clock source as the primary clock source and a line as the secondary clock source. If the primary and secondary clock sources fail, then the internal oscillator becomes the source.

Before using the **cnfclksrc** command, the PXM1 broadband interfaces and the service module lines must be configured. Therefore, you would first need to run the **addln** command, then the **addport** command. Configure only one clock source each time you execute **cnfclksrc**, and run the command from the active PXM1.

Table 1-6 Clock Sources

Clock Source	Description
Internal clock	Comes from an oscillator on the PXM1. It is the default source when the switch first comes up and remains so until you specify a different clock source.
Inband clock	Originates on a BPX 8600-series node or another vendor's switch and comes through the trunk on the PXM1 uplink card.
External clock	Comes from an external timing source and arrives at the T1 or E1 clock connector on the PXM UI. Frequently, the external source is a highly reliable, dedicated device that can provide a Stratum 2 or Stratum 3 clock. (As the subsequent configuration steps show, an additional step is necessary for an external clock source.)
Line on a service module or PXM1 UNI port	The PXM UNI line source is available on a stand-alone node only. A line must be active before you can specify it as a clock source.

Full Name

Configure Clock Source

Card(s) on Which This Command Executes

PXM, FRSM, CESM, AUSM

Syntax: PXM, FRSM, CESM, AUSM

cnfclksrc <slot.port> <clktype>

Syntax Description

slot.port

For the PXM1:

- Slot is 7, regardless of where the active PXM1 resides.
- Port range = 1–*n*, as appropriate for the physical installation.

For the FRSM, CESM, AUSM:

Slot and port number.

- Slot = 1–6, or 9–14, or 17–22, or 25–30.
- Port range = 1–*n*, as appropriate for the physical installation.

For the trunk to a BPX 8600-series or other backbone node-sourced clock:

- Port is always 1.

For the external clock:

- Port is always 35.

For the UNI line (stand-alone only):

- Port depends upon the number of lines on the back card.

For a service module providing the clock source:

- Slot is the slot number of the card.
- Port is the number of the line that provides the clock.

If you're using an external clock source:

Use the **cnfextclk** command to select the T1 or E1 line and the impedance of the line. The command syntax is

```
cnfextclk <ClockType> <Impedance>
```

where:

- *<ClockType>* 1 = T1 source, 2 = E1 source
- *<Impedance>* is one of the following:
 - T1 source: 1 = 75 ohms
 - E1 source: 2 = 100 ohms, 3 = 120 ohms

clktype

Value to set the clock type to be sourced on the specified interface.

- p = primary
- s = secondary
- n = null: use only for removing clock configuration that currently applies to the specified *slot.port*

Related Commands

dspclksrc, dspclkinf, cnfextclk

Attributes

Log: No State: Active Privilege: 1

Example 1-90 Configure the inband (trunk) interface as the primary clock source and an external clock device as the secondary source

```
spirit.1.8.PXM.a > cnfclksrc 7.1 P
```

```
spirit1r.1.8.PXM.a > cnfclksrc 7.35 S
```

cnfcon

Use the **cnfcon** command to configure connectivity parameters on the PXM, AUSM, FRSM, or CESM. The applicable parameters were previously specified by the **addcon** command.

Full Name

Configure Connection

Card(s) on Which This Command Executes

PXM, FRSM, AUSM, CESM

Syntax: PXM

cnfcon <conn_ID> <route_priority> <max_cost> <restrict_trunk_type> [CAC]

Syntax Description

conn_ID Connection identifier, in the format *PortNo.VPI.VCI*.

route_priority Routing priority number, in the range 1–15.

max_cost Maximum cost for the connection, in the range 1–255.

restrict_trunk_type Value to set restriction on the trunk.

- 1 = no restriction
- 2 = terrestrial trunk
- 3 = satellite trunk

CAC Optional value to enable or disable connection admission control.

- 1 = enable
- 2 = disable

Syntax: FRSM, AUSM
cnfcon <Port.Dlci> <chan_type> <cir> [CAC]

Syntax Description

<i>Port.Dlci</i>	Port number and DLCI.
<i>chan_type</i>	Value to set channel type. <ul style="list-style-type: none">• 1 = NIW• 2 = SIW-transparent• 3 = SIW-xlation• 4 = FUNI• 5 = frForward
<i>cir</i>	Committed rate, in the range appropriate for the interface. <ul style="list-style-type: none">• T1 range = 0–1536000• E1 range = 0–2048000• X.21 range = 0–10000000 bps• HSSI range = 0–20000000 bps
CAC	Optional value to enable or disable connection admission control. <ul style="list-style-type: none">• 1 = enable• 2 = disable

Syntax: CESM

cnfcon <port_num> <CDVT> <CLIP> <bufsize> <clockmode> <IdleSuppression>
<ForceSuppression>

Syntax Description

<i>port_num</i>	Unique port number.
<i>CDVT</i>	Cell delay variation, as appropriate for the interface. <ul style="list-style-type: none"> • T1 range = 125–24000 microseconds • E1 range = 125–26000 microseconds.
<i>CLIP</i>	Cell loss integration period, in the range 1000–65535 milliseconds.
<i>bufsize</i>	<ul style="list-style-type: none"> • egress bufsize = 0 to autocompute. • Min value depends on CDVT configured. • Min BufSize = greater (CDVT in frames * 2) * N, (CDVT + frames in 2 cells) * N} • Max for T1 UDT and E1 UDT: 16224 bytes • Max for T1 SDT: 384 * N bytes • Max for E1 SDT: 417 * N bytes, where N is the number of timeslots assigned in Nx64 connection, and N = 32 for T1/E1 UDT
<i>clockmode</i>	Value to set clock mode. <ul style="list-style-type: none"> • 1 = synchronous • 2 = SRTS • 3 = adaptive
<i>IdleSuppression</i>	Value to enable or disable idle suppression. <ul style="list-style-type: none"> • 1 = disable • 2 = enable
<i>ForceSuppression</i>	Value to enable or disable external idle suppression. <ul style="list-style-type: none"> • 1 = disable • 2 = enable

Related Commands

addcon, dspcon, dspcons, delcon

Attributes

Log: Yes State: Active Privilege: Any

Example 1-91 **Configures the connection on port 1 with a VCI of 2 and a VPI of 5 to use routing priority 15, a maximum routing cost of 255, to not use satellite trunks, and to enable connection admission control**

```
spirit01.1.7.PXM.a > cnfcon 1.2.5 15 255 3 2  
spirit01.1.7.PXM.a >
```

cnfdate

Use the **cnfdate** command to set the system date.

Full Name

Configure Date

Card(s) on Which This Command Executes

PXM

Syntax

cnfdate <*mm/dd/yyyy*>

Syntax Description

mm/dd/yyyy Month, day, year

- *mm* = month, in the range 01 through 12
- *dd* = day, in the range 01–31
- *yy* = year, in the 0000–9999

Related Commands

None

Attributes

Log: Yes State: Active Privilege: SuperUser

Example 1-92 Set date to be 11/24/1999

```
excel.1.3.PXM.a > cnfdate 11/24/1999
Date = 11/24/1999

excel.1.3.PXM.a >
```

cnfdsx3bert

Use the **cnfdsx3bert** command to specify a pattern for BERT testing on the FRSM.

Full Name

Configure DS3 BERT

Card(s) on Which This Command Executes

FRSM 2T3E3, CESMT3

Syntax

cnfdsx3bert <test pattern>

Syntax Description

<i>test pattern</i>	Value to define DSX3 BERT pattern
	<ul style="list-style-type: none">• 1 = all ones• 2 = all zeros• 3 = alternating ones and zeroes• 4 = double alternating ones and zeros• 5 = 3 in 24• 6 = 1 in 16• 7 = 1 in 8• 8 = 1 in 4• 9 = D4 loop activate• 10 = D4 loop deactivate• 11 = 2**3-1• 12 = 2**4-1• 13 = 2**5-1• 14 = 2**6-1• 15 = 2**7-1• 16 = FT1 LB activate• 17 = FT1 LB deactivate• 18 = 2**9-1• 19 = 2**10-1• 20 = 2**11-1• 21 = 2**15-1• 22 = 2**17-1• 23 = 2**18-1• 24 = 2**20-1• 25 = QRSS• 26 = 2**21-1• 27 = 2**22-1• 28 = 2**23-1• 29 = 2**25-1• 30 = 2**28-1• 31 = 2**28-1• 32 = 2**31-1• 33 = 2**32-1

Related Commands

None

Attributes

Log: Yes State: Active Privilege: SuperUser

Example 1-93 Set the double alternating ones-and-zeroes pattern for the BERT

```
popeye1.1.21.CESMT3.a > cnfdsx3bert 4
```

```
popeye1.1.21.CESMT3.a >
```

cnfegrservtype

Use the **cnfegrservtype** command to change the Egress port servicing algorithm. Egress port queue servicing type is a card level option. You can choose either four-queue, Weighted Fair Queuing (WFQ) algorithm with quality of service guaranteed, or simple ratio-based, two-queue algorithm without quality of service.

Software Version

Command available with 1.1.20 and higher

Full Name

Configure Egress Servicing Type

Card(s) on Which This Command Executes

FRSM-VHS (2CT3/2T3/2E3/HS2)

Syntax

cnfegrservtype <servicing type>

Syntax Description

servicing type A value representing one of the following servicing types:

- 87 = WFQ algorithm with four queues.
- 99 = Ratio-based algorithm with two queues.

Related Commands

dspegrservtype

Attributes

Log: Yes State: Active Privilege: SuperUser

Example 1-94 Configure Egress service type to queue ratio

```
raviraj.1.10.VHS2CT3.a > cnfegrservtype "99"
The card will be reset, Do you want to proceed (Yes/No)? Yes

Err: card reset/removed/failed on slot 10
slot 2 (cardInx 3) is present, insertion msg from PXM 7
```

cnfextclk

Use the **cnfextclk** command to configure the line type and impedance of the external clocking source.

Full Name

Configure External Clocking

Card(s) on Which This Command Executes

PXM

Syntax

cnfextclk <*ClockType*> <*Impedance*>

Syntax Description

ClockType Value to set is the clock source on the line.

- 1 = T1
- 2 = E1

Impedance Value to set impedance for the line selected as the external clocking source.

- 1 = 75 ohms
- 2 = 100 ohms
- 3 = 120 ohms

Related Commands

dspextclk

Attributes

Log: Yes

State: Active

Privilege: Group3

Example 1-95 Configure the clocking to be extracted from an E1 line with an impedance of 100 ohms

```
excel.1.3.PXM.a > cnfextclk 2 2
excel.1.3.PXM.a >
```

cnfenetgw

Use the **cnfenetgw** command to establish the Ethernet gateway route permanently.

Software Version

Command available with 1.1.20 and higher

Full Name

Configure Ethernet Gateway

Card(s) on Which This Command Executes

PXM

Syntax

cnfenetgw <IPaddress>

Syntax Description

IPaddress IP address for the default gateway; a subnet.

Related Commands

dspenetgw

Attributes

Log: No State: Active Privilege: Super Group

Example 1-96 Configures the gateway 172.29.37.1 and adds the necessary routes

```
excel.1.3.PXM.a > cnfenetgw 172.28.37.1  
excel.1.3.PXM.a >
```

cnfst

Use the **cnfst** command to configure ForeSight parameters for the current card.

Full Name

Configure ForeSight

Card(s) on Which This Command Executes

FRSM, AUSM

Syntax

cnfst <rate_up> <rate_down> <rate-fast_down> <qir_time_out> <rtd_interval>

Syntax Description

<i>rate_up</i>	Rate up, in the range 1–100 percent. If free bandwidth is available, this setting is the rate at which ForeSight increases transmission (as a percentage of MIR).
<i>rate_down</i>	Rate down, in the range 1–100 percent. If free bandwidth becomes unavailable, this setting is the rate at which ForeSight decreases transmission (as a percentage of current rate).
<i>rate-fast_down</i>	Rate fast down, in the range 1–100 percent. If a cell is dropped or the TxQ is full, this setting is the rate at which ForeSight decreases transmission (as a percentage of current rate).
<i>qir_time_out</i>	QIR timeout period before resetting IR to QIR, in the range 1–255 seconds.
<i>rtd_interval</i>	Interval between Round Trip Delay measurement requests, in the range 1–255 seconds.

Related Commands

dspfst

Attributes

Log: Yes State: Active Privilege: 1–2

cnfif

Use the **cnfif** command to modify parameters for an existing broadband interface on a PXM. System software does not allow you to conflict with existing configurations. You may need to reduce the bandwidth allocation or VPI/VCI range on one or more interfaces before you expand the resources for a interface. Refer to the **upif** command description for more information on resource partitioning.

Full Name

Configure a Broadband Interface

Card(s) on Which This Command Executes

PXM

Syntax

```
cnfif <if_num> <pct_bw> <min_vpi> <max_vpi>
```

Syntax Description

<i>if_num</i>	Interface number of the logical interface, in the range 1–32.
<i>pct_bw</i>	Percentage of the line bandwidth to be allocated for the logical interface, in the range 0–100. This setting applies to both the ingress and egress.
<i>min_vpi</i>	Minimum VPI value for UNI or NNI. <ul style="list-style-type: none">• UNI range = 0–255• NNI range = 0–4095 UNI typically applies to a line connecting a stand-alone node to a workstation.
<i>max_vpi</i>	Maximum VPI value for UNI or NNI. <ul style="list-style-type: none">• UNI range = 0–255• NNI range = 0–4095 UNI typically applies to a line connecting a stand-alone node to a workstation.

Related Commands

upif

Attributes

Log: No

State: Any

Privilege: Any

Example 1-97 Configure broadband interface number 1 to use 10% of the line bandwidth for both ingress and egress, have a minimum virtual path interface (VPI) of 0, and a maximum virtual path interface (VPI) of 19

```
wilco.1.7.PXM.a > cnfif 1 10 0 19
wilco.1.7.PXM.a >
```

Example 1-98 Confirm configuration for the broadband interface

```
wilco.1.7.PXM.a > dspif

  ifNum  Status  Line  ingrPctBw  egrPctBw  minVpi  maxVpi
-----
    1     Ena    1      10         10         0       19

wilco.1.7.PXM.a >
```

cnfifastrk

Use the **cnfifastrk** PAR command to configure a logical interface on the PXM to act as a feeder trunk. The application for this command is dependent upon the activation of the paid feature option of feeder capability on the MGX 8800 series switch node. Before configuring the interface as a feeder trunk the option must be activated with the **cnfswfunc** command. Therefore, the default is “rtrk” for routing trunk. The routing trunk utilization applies to both a routing node and a stand-alone node.

Full Name

Configure Interface as Trunk

Card(s) on Which This Command Executes

PXM

Syntax

cnfifastrk <slot,port> <iftype>

Syntax Description

<i>slot,port</i>	Slot and port number. <ul style="list-style-type: none">• slot = enter the value 7, or 15, or 31• port range = 1–n, as appropriate for the physical installation
<i>iftype</i>	Trunk type. <ul style="list-style-type: none">• ftrk = feeder trunk• rtrk = routing trunk (default)

Related Commands

uncnfifastrk

Attributes

Log: No State: Active Privilege: 2

Example 1-99 Configure line 1 on the PXM in slot 7 as a feeder trunk

```
wilco.1.7.PXM.a > cnfifastrk 7.1 ftrk
wilco.1.7.PXM.a >
```

cnfifip

Use the **cnfifip** command to configure the interface address for LAN, SLIP, or ATM on the PXM. In addition, you can specify an interface to be up or down dynamically. No reboot is required to bring an interface up or down, and interfaces set to “down” are persistent across resets.

A shelf now can have one or two IP addresses for Ethernet. The shelf IP address set using the **cnfifip** command will always be the IP address of the active card.

The bootChange IP address is used for the standby card and backup boot if it is different from the shelf IP address. If the bootChange IP address is same as the shelf IP address, then the Ethernet interface on the standby card or in backup boot is left in the down state.

Software Version

New feature (up/down IP interface) available with 1.1.20 and higher

Full Name

Configure Interface Address

Card(s) on Which This Command Executes

PXM

Syntax

cnfifip <Interface> [[<IP_Addr> <Net_Mask> <BroadcastAddr>] | InterfaceFlag]

Syntax Description

<i>Interface</i>	Value to set interface as Ethernet, SLIP, or ATM. <ul style="list-style-type: none"> • 26 = Ethernet • 28 = SLIP • 37 = ATM
<i>IP_Addr</i>	32-bit IP address in dotted decimal format.
<i>Net_Mask</i>	<n>.<n>.<n>.<n> where <n> = integer 0–255 If netmask “255.255.255.252” is used for the SLIP interface, the PXM will automatically add host route for its peer whenever the interface is turned ON.
<i>BroadcastAddr</i>	<n>.<n>.<n>.<n> where <n> = integer 0–255.
<i>InterfaceFlag</i>	Interface flag, either UP or DOWN.

Related Commands

dspifip

Attributes

Log: Yes

State: Active only

Privilege: Super Group

Example 1-100 Configure the ATM interface and bring it up

```
wilco.1.7.PXM.a > cnfifip atm 192.9.200.1 255.255.255.128  
wilco.1.7.PXM.a >
```

A system response does not occur unless an error is detected. To confirm your configuration for the interface address, use the **dspifip** command.

Example 1-101 Configure the ATM interface with the current information in the database

```
wilco.1.7.PXM.a > cnfifip atm up  
wilco.1.7.PXM.a >
```

Example 1-102 Remove the ATM interface and preserve the information in the database

```
wilco.1.7.PXM.a > cnfifip atm down  
wilco.1.7.PXM.a >
```

cnfilmi

Use the **cnfilmi** command to configure the local management interface port on the PXM or AUSM. A system response does not occur unless an error is detected.

Full Name

Configure ILMI

Card(s) on Which This Command Executes

PXM, AUSM

Syntax: PXM

```
cnfilmi <ifNum> <bbIfSigPortNum> <ilmiEnable> <sigProtocolType> <signallingVPI>  
<signallingVCI> <iLMITrap> <minTrapInterval> <keepAlive> <errorThresholdN491>  
<pollingIntervalT491> <eventThresholdN492> <minEnquiryIntervalT493> <addrRegEnable>
```

Syntax Description

<i>ifNum</i>	Interface number.
<i>bbIfSigPortNum</i>	Broadband interface signal port number, in the range 1–32.
<i>ilmiEnable</i>	Enable or disable ILMI. <ul style="list-style-type: none">• 1 = disable• 2 = enable
<i>sigProtocolType</i>	Value to set signal protocol type. <ul style="list-style-type: none">• 1 = other• 2 = no signalling• 3 = ILMI
<i>signallingVPI</i>	Signaling virtual path identifier, in the range 0–4095.
<i>signallingVCI</i>	Signaling virtual channel identifier, in the range 0–4095.
<i>iLMITrap</i>	Enable or disable ILMI trap. <ul style="list-style-type: none">• 1 = disable• 2 = enable
<i>minTrapInterval</i>	Minimum trap interval, in the range 1–10 seconds.
<i>keepAlive</i>	Enable or disable keep alive function. <ul style="list-style-type: none">• 1 = disable• 2 = enable
<i>errorThresholdN491</i>	Error threshold N491, in the range 1–10.
<i>pollingIntervalT491</i>	Polling interval T491, in the range v1–v12.
<i>eventThresholdN492</i>	Event threshold N492, in the range 1–10.
<i>minEnquiryIntervalT493</i>	Minimum enquiry interval, in the range 1–20.
<i>addrRegEnable</i>	Enable or disable address registration. <ul style="list-style-type: none">• 1 = disable• 2 = enable

Syntax: AUSM

cnfilmi <port_num> <signal_type> <vpi> <vci> <scr> <trap_enable> <min_trap_int>
<keep_alive>

Syntax Description

<i>port_num</i>	Port number, in the range 1–8.
<i>signal_type</i>	Value to set signalling type. <ul style="list-style-type: none">• 1 = other• 2 = no signalling• 3 = ILMI
<i>vpi</i>	Virtual path identifier, in the range 0–259.
<i>vci</i>	Virtual circuit identifier, in the range 0–65535.
<i>trap_enable</i>	Value to enable or disable ILMI trap. <ul style="list-style-type: none">• 1 = disable• 2 = enable
<i>min_trap_int</i>	Minimum trap interval, in the range 1–10 seconds.
<i>keep_alive</i>	Value to enable or disable Keep Alive Polling. <ul style="list-style-type: none">• 1 = disable• 2 = enable

Related Commands

dspilmi, dspilmicnt

Attributes

Log: Yes State: Active Privilege: 1 (Cisco for PXM)

cnfimagr

Use the **cnfimagr** command to configure delay and resilient links Inverse Multiplexing ATM (IMA) parameters on the current AUSM card.

Full Name

Configure IMA Group

Card(s) on Which This Command Executes

AUSM

Syntax

```
cnfimagr <grp> <max_diff_delay> <min_num_links>
```

Syntax Description

<i>grp</i>	IMA group number, in the range 1–8.
<i>max_diff_delay</i>	Maximum tolerable differential delay between the various links in the IMA group in the range appropriate for the SM type. <ul style="list-style-type: none">• AUSM8-T1 = 0–275 milliseconds• AUSM8-E1 = 0–200 milliseconds
<i>min_num_links</i>	Number of resilient links in the inverse multiplexer. This setting is the number of links the system can lose from this IMA group without bringing it down. Default = one less than the number of links in the selected group.

Related Commands

dspimagr, dspimagrps, dspimagrpcnt

Attributes

Log: Yes State: Active Privilege: 1–2

Example 1-103 Configure AIMUX group 1 on the AUSM card in slot 17 to have a read/write pointer differential of 5, a link loss severity of 2, a maximum tolerable differential delay of 5, and 2 redundant links

```
flyers01.1.17.AUSM.a > cnfimagr 1 -rwdiff 5 -severity 2 -maxdiff 3 -red 2  
flyers01.1.17.AUSM.a >
```

cnfln

Use the optional **cnfln** command to configure line characteristics after the line becomes active (see **addln**). Applicable cards are the core cards and service modules. For the PXM1 and optional SRM, a syntax *switch* or command *delineator* is necessary to identify the interface type as well as the parameters. (See syntax descriptions that follow.)

Note On the PXM1 CLI, all parameters for this command are optional and position-independent. Therefore, you can enter them in any order after the interface identifier. A parameter value is mandatory only if you type the delineator for that parameter.

Full Name

Configure Line

Card(s) on Which This Command Executes

PXM, FRSM, AUSM, CESM, VISM

Note The **cnfln** command on the PXM supports a loopback parameter.

On all PXM interfaces, a loopback is available. The *local* loopback exists between the daughter card and the back card. The remote loopback exists between the CPE or switch and the PXM daughter card. With a remote loopback, the data originates on the CPE or external switch, arrives at the PXM daughter card, then returns to the remote equipment. (See Figure 1-4.)

Figure 1-4 Local and Remote Loopbacks on the PXM

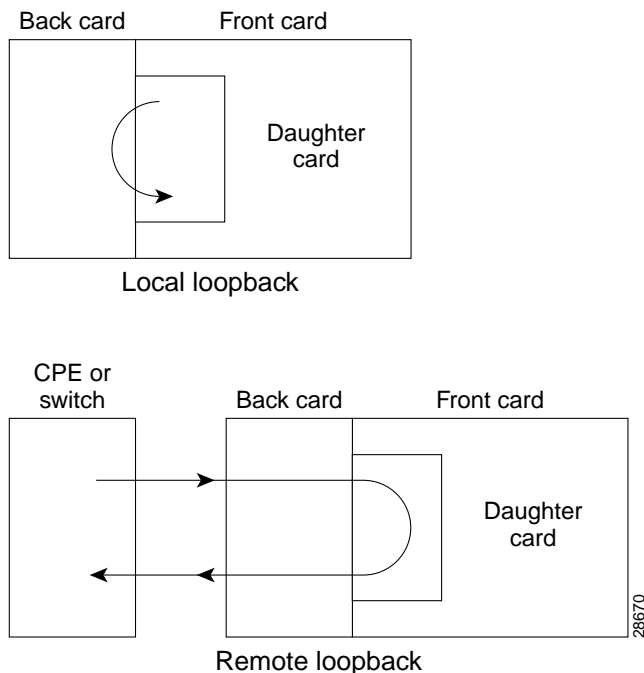

Syntax: PXM (SONET)

```
cnfln -sonet <LineNum> -slt <LineType> -lpb <LoopCmd> -smask <HCSmasking>
-sps <PayloadScramble> -sfs <FrameScramble>
```

Syntax Description

- sonet** Command delineator that precedes the *LineNum* entry.
- LineNum* Line number in the format *slot.line*.
 - Slot number is 7 or 8.
 - The line number is 1 for the OC-12 card or in the range 1–4 for the OC-3 card.
- slt** Command delineator that precedes the *LineType* entry.
- LineType* Line type:
 - 1 = sonetSts3c
 - 2 = sonetStm1
 - 3 = sonetSts12c
 - 4 = sonetStm4
- lpb** Command delineator that precedes the *LoopCmd* entry.

<i>LoopCmd</i>	Loopback mode of the SONET interface. <ul style="list-style-type: none">• 1 specifies no loopback. The purpose is to remove an existing loopback.• 2 specifies that the near end loops back data from the remote end.• 3 specifies that the near end loops back local data.
-smask	Command delineator that precedes the <i>HCSmasking</i> entry.
<i>HCSmasking</i>	Enable or disable HCS masking. <ul style="list-style-type: none">• 1 = disable• 2 = enable
-sps	Command delineator that precedes the <i>PayloadScramble</i> entry.
<i>PayloadScramble</i>	Enable or disable payload scramble. <ul style="list-style-type: none">• 1 = disable• 2 = enable
-sfs	Command delineator that precedes the <i>FrameScramble</i> entry.
<i>FrameScramble</i>	Enable or disable frame scramble. <ul style="list-style-type: none">• 1 = disable• 2 = enable

Syntax: PXM (T3)

cnfln -ds3 <LineNum> -lc <LineCoding> -len <LineLength> -oof <LineOOFCriteria>
-cb <LineAIScBitsCheck> -lpb <LoopCmd> -rfeac <LineRcvFEACValidation>

Syntax Description

-ds3	Command delineator that precedes the <i>LineNum</i> entry.
<i>LineNum</i>	DS3 line number in the format <i>slot.port</i> and has the following possible values: <ul style="list-style-type: none"> • For a PXM1, the slot is 7 or 8. For an optional SRM (controlled from the PXM1 CLI), the slot is 15, 16, 31, or 32. • The port is 1–2 for a PXM1 or 1–3 for an SRM.
-lc	Command delineator that precedes the <i>LineCoding</i> entry.
<i>LineCoding</i>	Value to set line coding for Zero Code Suppression B3ZS or HDB3. <ul style="list-style-type: none"> • 1 = B3ZS on a dsx3 line • 2 = HDB3 on an E3 line
-len	Command delineator that precedes the <i>LineLength</i> entry.
<i>LineLength</i>	Value to set number of line feet. <ul style="list-style-type: none"> • 1 = less than 225 feet • 2 = 225 feet or more
-oof	Command delineator that precedes the <i>LineOOFCriteria</i> entry.
<i>LineOOFCriteria</i>	Value to set threshold for triggering an Out Of Frame condition. <ul style="list-style-type: none"> • 1 = 3 out of 8 An Out Of Frame condition is declared if at least 3 of 8 framing bits are in error. • 2 = 3 out of 16 An Out Of Frame condition is declared if at least 3 of 16 framing bits are in error.
-cb	Command delineator that precedes the <i>LineAIScBitsCheck</i> entry.
<i>LineAIScBitsCheck</i>	Value to set test of the c-bit in response to AIS status. <ul style="list-style-type: none"> • 1 = check the c-bit • 2 = ignore the c-bit
-lpb	Command delineator that precedes the <i>LoopCmd</i> entry.
<i>LoopCmd</i>	Loopback mode of the DS3/T3 interface. The looped data is the line framing synchronization and is sent every 10 ms. The loop exists on the daughter card attached to the PXM1 front card. The back card is involved only as a passive part of the loopback and only in the case of a remote loopback. For remote loopback, the far end can be CPE on a UNI port or a switch at the far end of a trunk. For local loopback, the data passes between only the PXM1 front card and the daughter card. Note that the mere execution of a loop may clear line alarms. <ul style="list-style-type: none"> • 1 specifies no loopback. The purpose is to remove an existing loopback. • 2 specifies that the near end loops back data from the remote end. • 3 specifies local data loopback.
-rfeac	Command delineator that precedes the <i>LineRcvFEACValidation</i> entry.

LineRcvFEACValidati A number to specify criteria to validate far-end alarm and control (FEAC) code.
on

- Enter 1 to specify 4 out of 5. A valid FEAC code is declared if 4 of 5 codes match.
- Enter 2 to specify 8 out of 10. A valid FEAC code is declared if 8 of 10 codes match.

Syntax: PXM E3

cnfln -e3 <LineNum> -lc <LineCoding> -len <LineLength> -lpb <LoopCmd>
-topt <TrailTraceOption> -txtt <txTrailTrace> -txma <txTimingMarker>
-rxma <rxTimingMarker> -txpt <txPayloadType>

Syntax Description

-e3	Command delineator that precedes the <i>LineNum</i> entry.
<i>LineNum</i>	Line number in the format <i>slot.line</i> and has the following possible values: <ul style="list-style-type: none"> • For a PXM1, the slot is 7 or 8. For an optional SRM (controlled from the PXM1 CLI), the slot is 15, 16, 31, or 32. • The line number is 1–2 for the E3 back card on the PXM1. No E3 back card exists for the SRM.
-lc	Command delineator that precedes the <i>LineCoding</i> entry.
<i>LineCoding</i>	Value to set line coding for Zero Code Suppression B3ZS or HDB3. <ul style="list-style-type: none"> • 1 = B3ZS on a dsx3 line • 2 = HDB3 on an E3 line
-len	Command delineator that precedes the <i>LineLength</i> entry.
<i>LineLength</i>	Value to set number of line feet. <ul style="list-style-type: none"> • 1 = less than 225 feet • 2 = 225 feet or more
-lpb	Command delineator that precedes the <i>LoopCmd</i> entry.
<i>LoopCmd</i>	Loopback mode of the E3 interface. <ul style="list-style-type: none"> • 1 specifies no loopback. The purpose is to remove an existing loopback. • 2 specifies that the near end loops back data from the remote end. • 3 specifies local data loopback.
-topt	Command delineator that precedes the <i>TrailTraceOption</i> entry.
<i>TrailTraceOption</i>	Enable or disable trail trace. <ul style="list-style-type: none"> • 1 = disable • 2 = enable
-txtt	Command delineator that precedes the <i>txTrailTrace</i> entry.
<i>txTrailTrace</i>	Length of the trail trace string in the transmit direction (away from the switch). The maximum length of <i>txTrailTrace</i> is 16 bytes.
-txma	Command delineator that precedes the <i>txTimingMarker</i> entry.
<i>txTimingMarker</i>	Value to set the timing marker tracer during outbound transmission. <ul style="list-style-type: none"> • 1 = traceable • 2 = untraceable
-rxma	Command delineator that precedes the <i>rxTimingMarker</i> entry.
<i>rxTimingMarker</i>	Value to set the timing marker tracer during inbound transmission. <ul style="list-style-type: none"> • 1 = traceable • 2 = untraceable
-txpt	Command delineator that precedes the <i>txPayloadType</i> entry.

txPayloadType Value to set payload type.

- 1 = unequipped
- 2 = equipped
- 3 = ATM
- 4 = sdhtu12s

Syntax: FRSM 8T1, 8E1, 2CT3

cnfln <line_num> <line_type> <clk_src>

Syntax Description

line_num DS1 Line number, in the range 1–56.

line_type Value to define type of line to be configured.

- 1 = dsx1ESF
- 2 = dsx1D4

clk_src Value to define DSX1 clock source.

- 1 = loop clock
- 2 = local clock

Syntax: FRSM 2T3, 2E3, 2CT3, HS2

cnfds3ln <line_num> <line_type> <line_len> <clk_src>

Syntax Description

<i>line_num</i>	DS3 Line number, in the range 1–2.
<i>line_type</i>	Value to define type of line to be configured. <ul style="list-style-type: none">• 1 = C-bit parity• 2 = g832_g804• 3 = M13• 4 = g751
<i>line_len</i>	Value to define length of line. <ul style="list-style-type: none">• 1 = less than 225 feet• 2 = greater than 225 feet
<i>clk_src</i>	Value to define DSX3 clock source. <ul style="list-style-type: none">• 1 = backplane clock• 2 = recovery clock• 3 = local clock

Syntax: FRSM HS1/B

cnfln <line_num> <line_type> <line_rate>

Syntax Description

line_num Line number, in the range 1–4.

line_type Value to define line type.

- 1 = DTE
- 2 = DCE
- 3 = DTE_ST (V.35 only)

line_rate Value to define line rate, in the range 48 Kbps - 52 Mbps.

1=	48000	11=	320000	21=	1792000	31=	6315000	41=	12629000
2=	56000	12=	336000	22=	1920000	32=	7744000	42=	13897000
3=	64000	13=	384000	23=	1984000	33=	7899000	43=	14222000
4=	112000	14=	392000	24=	2048000	34=	8192000	44=	14336000
5=	128000	15=	448000	25=	3097000	35=	9289000	45=	15488000
6=	168000	16=	512000	26=	3157000	36=	9472000	46=	15799000
7=	192000	17=	768000	27=	4096000	37=	10240000	47=	16384000
8=	224000	18=	1024000	28=	4645000	38=	10890000	48=	20025000
9=	256000	19=	1536000	29=	4736000	39=	11059000	49=	24986000
10=	280000	20=	1544000	30=	6195000	40=	12390000	50=	52000000

AUSM, CESM, VISM (for T1 or E1)

cnfln <line_num> <line_code> <line_len> <clk_src> [E1-signaling]

Syntax Description

<i>line_num</i>	Line number, in the range 1–8.
<i>line_code</i>	Value to set line coding. <ul style="list-style-type: none"> • 2 = B8ZS, applies to T1 • 3 = HDB3, applies to E1 • 4 = AMI, applies to T1 or E1
<i>line_len</i>	Line length, as appropriate for the interface. <ul style="list-style-type: none"> • T1: 10–15 • E1 with SMB module: 8 • E1 with R-J48 module: 9
<i>clk_src</i>	Value to set clock source as either loop clock or local clock. <ul style="list-style-type: none"> • 1 = loop clock • 2 = local clock
<i>E1-signaling</i>	<ul style="list-style-type: none"> • CAS: CAS, no CRC • CAS_CRC: CAS with CRC • CCS: CCS no CRC • CCS_CRC: CCS with CRC • CLEAR: Clear E1

Related Commands

addln, delln, dsplns, dspln

Attributes

Log: Yes State: Active Privilege: 1

Example 1-104 Configure line 4 on the current card (an AUSM in slot 4) to be T1 with B8ZS line coding, have a length of 10, and use the loop clock as a clock source

```
wilco.1.4.AUSM.a > cnfln 4 2 10 1
wilco.1.4.AUSM.a >
```

cnflnsubrate

Use **cnflnsubrate** to configure the T/E3 line subrate mode. This command provides T3/E3 line sub-rates for Digital Link and ADC Kentrox DSUs.

Possible errors associated with this command are

- Illegal/invalid parameters
- Feature is already enabled
- Line doesn't exist

Software Version

Command available with 1.1.20 and higher.

Full Name

Configure Line Subrate

Card(s) on Which This Command Executes

FRSM-2T3/2E3

Syntax

```
cnflnsubrate <line_num> <dsu_subrate_ena> <dsu_select> <dsu_scramble_ena> <dsu_line_rate>  
>
```

Syntax Description.

<i>line_num</i>	DS3 line number, in the range 1 to 2.
<i>dsu_subrate_ena</i>	One of the following values: <ul style="list-style-type: none">• 1 = disable• 2 = enable
<i>dsu_select</i>	One of the following modes: <ul style="list-style-type: none">• 1 = Digital Link 3100 Mode• 2 = ADC-Kentrox
<i>dsu_scramble_ena</i>	DSU line scrambling; either: <ul style="list-style-type: none">• 1 = disable• 2 = enable
<i>dsu_line_rate</i>	A DSU line rate, values ranging from x to y. <i>For DL3100:</i> <ul style="list-style-type: none">• FRSM-2T3: x = 300, y = 44210• FRSM-2E3: x = 358, y = 34010 <i>For ADC-Kentrox Mode:</i> <ul style="list-style-type: none">• FRSM-2T3/E3: x = 500, y = 44210 or 34010 in steps of x-value

Related Commands**dsps3ln****Attributes**

Log: Yes State: Active Privilege: 1-2

cnfname

Use the **cnfname** PAR command to set the switch name. The name can consist of letters, special characters “_” and “-” and numbers. It must begin with a letter and cannot contain spaces. The name is case sensitive.

Full Name

Configure Name

Card(s) on Which This Command Executes

PXM

Syntax

cnfname <node name>

Syntax Description

node name Node name consisting of up to eight alpha-numeric characters.

Related Commands

None

Attributes

Log: Yes State: Active Privilege: 1

Example 1-105 The prompt returns with the new name. However, on the command line, the name is truncated to eight characters because of the information displayed in the prompt

```
NODENAME.1.7.PXM.a > cnfname kanchendzonga  
kanchend.1.3.PXM.a >
```

cnfoamlpbk

Use the **cnfoamlpbk** command to configure the OAM loopback test. This nonintrusive test sends OAM cells to an idle PVC, one not receiving data for a whole minute, to verify connection continuity. No remote end loopback is necessary for this test to run. OAM cells are automatically recognized and returned without the need for the remote end to be looping back all data. If the end points reside in Fast Packet cards, then “test delay” cells are transmitted instead of OAM loopback cells.

The OAM cell is initiated at an end point and sent into the network, where it will be returned by the card at the remote end of the connection. (Note that the cells do not go through NNI trunks.) When ten consecutive cells are not received, the PVC is declared failed. The test logs alarms when significant continuous cell loss is encountered.

Once a failed PVC is detected, the local end from which the test started sends a network message to the end point node indicating a failure. This provides consistent network views for both ends of the connection.

Full Name

Configure OAM Loopback

Card(s) on Which This Command Executes

FRSM 2T3/E3, FRSM HS2

Syntax

cnfoamlpbk <action> <frequency>

Syntax Description

action One of the following actions:

- 1 = OamRas enabled
- 2 = OamRas disabled

frequency Frequency at which the loopback cells should be sent, in the range 1 to 10 minutes.

Related Commands

dspoamlpbk

Attributes

Log: Yes State: Any Privilege: Any

Example 1-106 Send OAM cells every 10 minutes on an FRSM-2CT3 card

```
NODENAME.1.19.VHS2CT3.a > cnfoamlpbk 1 10
NODENAME.1.19.VHS2CT3.a >
```

cnfpasswd

Use the **cnfpasswd** command to set the password for the specified User ID. Enter the command without arguments to change your own password. Prompts are presented to let you enter the new password and to confirm it.

Full Name

Configure Password

Card(s) on Which This Command Executes

PXM

Syntax

cnfpasswd [*user_id*]

Syntax Description

user_id User name.

Related Commands

cnfpwd

Attributes

Log: Yes State: Active Privilege: Any

Example 1-107 Change your own password. Prompts appear for you to enter the new password and confirm it.

```
spirit4.1.8.PXM.a > cnfpasswd
```

```
Enter password:  
Re-enter password:
```

```
spirit4.1.8.PXM.a >
```

cnfplpp

Use the **cnfplpp** command to set PLPP parameters on the current AUSM card.

Full Name

Configure PLPP

Card(s) on Which This Command Executes

AUSM

Syntax

cnfplpp <phy_port_num> <loopback> <scramble> <singlebit_errcorr_ena>

Syntax Description

<i>phy_port_num</i>	Physical port number, in the range 1–8.
<i>loopback</i>	Value to set PLPP loopback. <ul style="list-style-type: none"> • 1 = no loopback • 2 = remote loopback • 3 = local loopback
<i>scramble</i>	Enable or disable cell scramble. <ul style="list-style-type: none"> • 1 = no scramble • 2 = scramble
<i>singlebit_errcorr_ena</i>	Enable or disable single-bit error correction. <ul style="list-style-type: none"> • 1 = disable • 2 = enable

Related Commands

dsplpp

Attributes

Log: Yes State: Active Privilege: 1–2

Example 1-108 Configure the PLPP parameters on port 1 on the current AUSM card in slot 22 to disable cell scramble, to disable PLPP loopback, and to disable single-bit error correction.

```
spirit3.1.22.AUSM8.a > cnfplpp 1 1 1 1
spirit3.1.22.AUSM8.a >
```

A system response does not occur unless an error is detected. To confirm your configurations for PLPP parameters, use the **dsplpp** command.

Example 1-109 Confirm PLPP configuration

```
spirit3.1.22.AUSM8.a > dspplpp 1
  PhysicalPortNumber:      1
  CellFraming:             ATM
  CellScramble:            No Scramble
  Plpp Loopback:          No Loopback
  Single-bit error correction: Disabled

spirit3.1.22.AUSM8.a >
```

cnfport

Use the **cnfport** command to configure service port on an FRSM or a PXM. The configuration can be verified using the **dspport** command.

Full Name

Configure Port

Card(s) on Which This Command Executes

PXM, FRSM

Syntax: PXM

cnfport <port_number> <percent_bandwidth> <min_VPI> <max_VPI>

Syntax Description

<i>port_number</i>	Port number, in the range 1–32.
<i>percent_bandwidth</i>	Percentage of bandwidth to allocated on the port, in the range 1–100.
<i>min_VPI</i>	Minimum virtual path identifier, in the range 0–4095.
<i>max_VPI</i>	Maximum virtual path identifier, in the range 0–4095.

Syntax: FRSM

cnfport <port_num> <lmi_sig> <asyn> <ELMI> <T391> <T392> <N391> <N392> <N393>

Syntax Description

<i>port_num</i>	<p>Logical port number, in the range appropriate for the current card.</p> <ul style="list-style-type: none"> • FRSM <ul style="list-style-type: none"> — 8-port T1 range = 1–192 — 8-port E1 range = 1–248 — 4-port HS1 or HS2 range 1–4 — Unchannelized E1 or T1 range = 1–4 — 2-port HS1 or HS2 range = 1–2 — Unchannelized E3 or T3 = 1–2 — Channelized T3 = 1–56
<i>lmi_sig</i>	<p>LMI signaling protocol type.</p> <ul style="list-style-type: none"> • 1 = Other • 2 = None • 3 = StrataLMI • 4 = AnnexAUNI • 5 = AnnexDUNI • 6 = AnnexANNI • 7 = AnnexDNNI
<i>ELMI</i>	<p>Enable or disable enhanced LMI.</p> <p>N or n = disable</p> <p>Y or y = enable</p>
<i>asyn</i>	<p>Enable or disable asynchronous update.</p> <p>(y)es = enable</p> <p>(n)o = disable (default)</p>
<i>T391</i>	<p>T391 timer, in the range 5–30 seconds. This setting is the interval in seconds for NNI status polling.</p> <p>Default = 10</p>
<i>T392</i>	<p>T392 timer, in the range 5–30 seconds. This setting is the interval in seconds for UNI status polling.</p> <p>Default = 15</p>
<i>N391</i>	<p>N391 counter, in the range 1–255. This setting establishes the number of UNI/NNI polling cycles.</p> <p>Default = 6</p>
<i>N392</i>	<p>N392 counter, in the range 1–10. This setting is the UNI/NNI error threshold.</p> <p>Default = 3</p>
<i>N393</i>	<p>N393 counter, in the range 1–10. This setting is the UNI/NNI monitored events threshold, which must be greater than N392.</p> <p>Default = 4</p>

Related Commands

addport, delport, dspport, dspports

Attributes

Log: Yes

State: Active

Privilege: Any

Example 1-110 Configure the port parameters on PXM port 1, in slot 8, to allocate all the bandwidth and to set the VPI range for 0-4095

```
spirit3.1.8.PXM.a > cnfport 1 100 0 4095
spirit3.1.8.PXM.a >
```

cnfportcllm

Use the **cnfportcllm** command to set Consolidated Link Layer Management (CLLM) parameters for a specified port on the current card. Use CLLM to pass ForeSight to another Cisco WAN switching network using NNI.

Full Name

Configure Port CLLM

Card(s) on Which This Command Executes

FRSM

Syntax

cnfportcllm <port_num> <CLLMEN> <CLLMTM>

Syntax Description

<i>port_num</i>	Logical port number, in the range appropriate for the current card. <ul style="list-style-type: none"> • FRSM <ul style="list-style-type: none"> — 8-port T1 range = 1–192 — 8-port E1 range = 1–248 — 4-port HS1 (X.21) or HS2 range 1–4 — Unchannelized E1 or T1 range = 1–4 — 2-port HS1 (HSSI) or HS2 range = 1–2 — Unchannelized E3 or T3 = 1–2 — Channelized T3 = 1–56
<i>CLLMEN</i>	Enable or disable CLLM. <ul style="list-style-type: none"> • 1 = disable (default) • 2 = enable
<i>CLLMTM</i>	CLLM Time, in the range 40–5000 milliseconds. This setting is the amount of time to wait to receive CLLM updates before timing out. Default = 1000 (1 second)

Related Commands

dspportcllm

Attributes

Log: Yes State: Active Privilege: 1–2

cnfportq

Use the **cnfportq** command to configure queue parameters for a specified port on the current AUSM. A system response does not occur unless an error is detected.

Full Name

Configure Port Queue

Card(s) on Which This Command Executes

AUSM

Syntax

cnfportq <port_num> <q_num> <q_algo> <q_depth> <clp_high> <clp_low> <efci_thres>

Syntax Description

<i>port_num</i>	Port number, in the range 1–8.
<i>q_num</i>	Value to set queue number. <ul style="list-style-type: none"> • 1 = CBR • 2 = ABR • 3 = VBR • 4 = UBR
<i>q_algo</i>	Queue algorithm, in the range 1–5. 0 = disable queue
<i>q_depth</i>	Queue depth is the maximum queue depth, in the range 1–16000 cells.
<i>clp_high</i>	CLP high is the high Cell Loss Priority, in the range 1–16000 cells.
<i>clp_low</i>	CLP low is the low Cell Loss Priority, in the range 1–16000 cells.
<i>efci_thres</i>	EFCI threshold is the EFCI threshold, in the range 1–16000 cells.

Related Commands

None

Attributes

Log: Yes State: Active Privilege: 1

cnfportrsprtn

Use the **cnfportrsprtn** command to configure the resources each controller application receives at a port.

You need to configure partitions at the port level if:

- You configured card-level resource partitioning to be off.
- You configured resource partitioning to be on, with or without specified controller allocations.

Full Name

Configure Port Resource Partition

Card(s) on Which This Command Executes

PXM, AUSM, FRSM, CESM, VISM

Syntax: PXM

```
cnfportrsprtn <if_num> <ctrlr_num> <ingr_pct_bw> <egr_pct_bw> <min_vpi> <max_vpi>  
<min_vci> <max_vci> <max_chans>
```

Syntax Description

<i>if_num</i>	Logical interface number, in the range 1– 32.
<i>ctrlr_num</i>	Value to set network control application. <ul style="list-style-type: none">• 1 = PAR• 2 = PNNI• 3 = TAG
<i>ingr_pct_bw</i>	Percent of ingress bandwidth to be allocated on the interface, in the range 0–100.
<i>egr_pct_bw</i>	Percent of egress bandwidth to be allocated on the interface, in the range 0–100.
<i>min_vpi</i>	Minimum VPI Value, in the range 0–4095.
<i>max_vpi</i>	Maximum VPI Value, in the range 0–4095.
<i>min_vci</i>	Minimum VCI Value, in the range 0–65535.
<i>max_vci</i>	Maximum VCI Value, in the range 0–65535.
<i>max_chans</i>	Maximum number of GLCNs, in the range 0–32767.

Syntax: AUSM, FRSM, CESM, VISM

```
cnfportrsprtn <portnum> <controller> <conn ID range> <percent bandwidth> [number of conns]
```

Syntax Description

<i>port_num</i>	Logical port number, in the range appropriate for the current card. <ul style="list-style-type: none"> • FRSM <ul style="list-style-type: none"> — 8-port T1 range = 1–192 — 8-port E1 range = 1–248 — 4-port HS1 (X.21) or HS2 range 1–4 — Unchannelized E1 or T1 range = 1–4 — 2-port HS1 (HSSI) or HS2 range = 1–2 — Unchannelized E3 or T3 = 1–2 — Channelized T3 = 1–56
<i>controller</i>	Value to set controller type. <ul style="list-style-type: none"> • 1 = PAR • 2 = PNNI (currently not used) • 3 = Tag
<i>conn ID range</i>	Range of connection IDs available to the controller.
<i>percent bandwidth</i>	Percentage of the port bandwidth available to the controller. This setting applies to both the ingress and egress.
<i>number of conns</i>	Connections available to a controller on a port.

Related Commands

addcdrscrptn, cnfcdrscrptn

Attributes

Log: Yes State: Active Privilege: 1 (Service for PXM)

cnfprfparam

Use the **cnfprfparam** command to configure the bucket interval.

Full Name

Configure Preference Parameters

Card(s) on Which This Command Executes

PXM

Syntax

cnfprfparam <*bucket interval*>

Syntax Description

bucket interval Bucket interval, in the range 1-600 seconds.

Related Commands

dspprf, dspprfhist

Attributes

Log: No State: Active Privilege: Any

Example

```
popeye3.1.8.PXM.a > cnfprfparam 2  
The bucket interval will be effective after the current bucket interval is over.  
  
popeye3.1.8.PXM.a >
```

cnfrscprtn

Use the **cnfrscprtn** command to modify an existing resource partition. Refer to the description of **addrscprtn** for information on resource partitions.

A resource partition on a PXM consists of a percent of bandwidth, a VPI/VCI range, and the number of global logical connection numbers (GLCNs) available to a network control application. The current network control applications are Portable AutoRoute (PAR) and Tag Switching.

Full Name

Configure Resource Partition

Card(s) on Which This Command Executes

PXM

Syntax

```
cnfrscprtn <if_num> <ctrlr_num> <ingr_pct_bw> <egr_pct_bw> <min_vpi> <max_vpi>
<min_vci> <max_vci> <max_chans>
```

Syntax Description

<i>if_num</i>	Logical interface number, in the range 1–32.
<i>ctrlr_num</i>	Value to set network control application. <ul style="list-style-type: none"> • 1 = PAR • 2 = PNNI • 3 = TAG
<i>ingr_pct_bw</i>	Percent of ingress bandwidth to be allocated on the interface, in the range 0–100.
<i>egr_pct_bw</i>	Percent of egress bandwidth to be allocated on the interface, in the range 0–100.
<i>min_vpi</i>	Minimum VPI Value, in the range 0–4095.
<i>max_vpi</i>	Maximum VPI Value, in the range 0–4095.
<i>min_vci</i>	Minimum VCI Value, in the range 0–65535.
<i>max_vci</i>	Maximum VCI Value, in the range 0–65535.
<i>max_chans</i>	Maximum GLCNS, in the range 0–32767.

Related Commands

addrscprtn, delrscprtn, dspifrc, dspifs, dsprscprtns, dsprscprtn, dsplnrsc

Attributes

Log: Yes State: Any

Privilege: Service_GP

Example 1-111

```
MGX-01.1.2.PXM.a > cnfrsoprtn 1 1 100 100 0 4095 0 65535 32767
MGX-01.1.2.PXM.a >
```

cnfserialif

Use the **cnfserialif** command to configure the speed of a serial port.

Full Name

Configure Serial Interface

Card(s) on Which This Command Executes

PXM

Syntax

```
cnfserialif -if <serial_port_num> -sp <serial_port_speed>
```

Syntax Description

-if	Command delineator that precedes the <i>serial_port_num</i> entry.
<i>serial_port_num</i>	Serial port number. Enter the value 1 (for console) or 2 (for slip).
-sp	Command delineator that precedes the <i>serial_port_speed</i> entry.
<i>serial_port_speed</i>	Value to set port speed. <ul style="list-style-type: none">• 1 = 9600bps• 2 = 2400bps• 3 = 19200bps

Related Commands

dspserialif

Attributes

Log: Yes State: Active Privilege: 1–2

Example 1-112 Configure the speed on slip for 19200bps

```
NODENAME.1.7.PXM.a > cnfserialif -if 2 -sp 3

NODENAME.1.7.PXM.a > dspserialif -if 2
SerialPortNum      : 2
SerialPortType     : main
SerialPortEnable   : Enable
SerialPortBps      : 19200bps
```

cnfsiftst

Use the **cnfsiftst** command configure the self-test routine on the current card.

Full Name

Configure Self-Test

Card(s) on Which This Command Executes

FRSM, AUSM, CESM

Syntax

cnfsiftst -en <SelftestEnable> **-tm** <SelftestPeriod>

Syntax Description

- | | |
|------------------------|---|
| <i>-SelftestEnable</i> | Enable or disable self-test. <ul style="list-style-type: none">• 1 = disable• 2 = enable |
| <i>SelftestPeriod</i> | Period, in minutes, between self tests in the range 1–60. |

Related Commands

clrsiftst, dpsiftst, runsiftstno

Attributes

Log: No State: Any Privilege: Any

Example 1-113 Enable the self-test for the AUSM in slot 22, with a self-test period of five minutes

```
spirit3.1.22.AUSM8.a > cnfsiftst -en 2 -tm 5
spirit3.1.22.AUSM8.a >
```

cnfsnmp

Use the **cnfsnmp** command to view the community strings configured on a service module. The default SNMP community string is set to POPEYE.

Full Name

Configure SNMP

Card(s) on Which This Command Executes

PXM

Syntax

cnfsnmp <community string>

Syntax Description

community string The SNMP community string, up to 18 characters in length.

Related Commands

cnfsnmp

Attributes

Log: No State: Active Privilege: Superuser

Example 1-114 Configure the SNMP community string

```
popeye.1.7.PXM.a > cnfsnmp POPEYE2ST

popeye.1.7.PXM.a > dspnmp

Community String      :POPEYE2ST
```

cnfsrcmclsrc

Use the **cnfsrcmclsrc** command to configure the SRM clock source to be acquired from either the PXM or from an SRM-3T3 T3 line.

Full Name

Configure SRM Clock Source

Card(s) on Which This Command Executes

PXM

Syntax

cnfsrcmclsrc -ds3 <T3 line number> -srmclk <source number>

Syntax Description

- | | |
|-----------------------|--|
| -ds3 | Command delineator for the <i>T3 line number</i> entry. |
| <i>T3 line number</i> | SRM-3T3 T3 line number in the format <i>slot.port</i> . <ul style="list-style-type: none">• slot = enter a value from the range 7, 8, 15, 16, 31, 32.• line range = 1 to <i>n</i>, as appropriate for the card. |
| -srmclk | Command delineator for the <i>source number</i> entry. |
| <i>source number</i> | Value to set clock source. <ul style="list-style-type: none">• 1 = backplane clock, from PXM. (default)• 2 = recovery clock, from T3 line. |

Related Commands

dspsrmclsrc

Attributes

Log: No State: Active Privilege: Any

cnfstatsmgr

Use the **cnfstatsmgr** command to specify the IP address of the workstation with the statistics manager to the MGX 8800 series switch node. If the node on an MGX 8800 series switch does not have this IP address, it refuses requests for statistical information from the workstation that is running Cisco WAN Manager.

Full Name

Configure Statistics Manager

Card(s) on Which This Command Executes

PXM

Syntax

cnfstatsmgr <IP_Addr>

Syntax Description

IP_Addr 32-bit IP address in dotted decimal format.

Related Commands

dspttrapmgr

Attributes

Log: Yes State: Active Privilege: SuperUser

cnfswfunc

Use the **cnfswfunc** PAR command to set certain node-level, paid features on an MGX 8800 series switch. The features are the feeder implementation of the switch and virtual source/virtual destination (VSVD) control for ABR traffic. The defaults are disabled for VSVD and the routing implementation of the MGX 8800 series switch.

Full Name

Configure Software Function

Card(s) on Which This Command Executes

PXM

Syntax

```
cnfswfunc -vsvd <enable(yes) | disable(no)> -ndtype <fdr | routing>
```

Syntax Description

-vsvd	Command delineator that precedes the <i>enable</i> entry or <i>disable</i> entry.
enable(yes)	Character that enables or disables VSVD.
disable(no)	<ul style="list-style-type: none">• e = enable• d = disable
-ndtype	Command delineator that precedes the <i>fdr</i> <i>routing</i> entry.
<i>fdr</i> <i>routing</i>	Node implementation. <ul style="list-style-type: none">• fdr = feeder implementation• routing = either the stand-alone or routing node implementation• Default = routing

Note The **cnfswfunc** command does not let you enable more than one feature at a time.

Related Commands

dpswfunc

Attributes

Log: No

State: Active

Privilege: Service

Example 1-115

```
wilco.1.7.PXM.a > cnfswfunc -vsvd yes -ndtype routing
wilco.1.7.PXM.a >
```

cnftime

Use the **cnftime** command to set the time on the PXM. The node uses a 24-hour clock.

Full Name

Configure Time

Card(s) on Which This Command Executes

PXM

Syntax

cnftime <*hh:mm:ss*>

Syntax Description

hh:mm:ss Hour, minutes, seconds

- *hh* = hour, in the range 01–24
- *mm* = day, in the range 01–60
- *ss* = year, in the range 01–60

Related Commands

cnftmzn, cnfdate

Attributes

Log: Yes State: Active Privilege: SuperUser

Example 1-116 Set time for 2 p.m. plus 11 minutes and 22 seconds

```
excel.1.3.PXM.a > cnftime 14:11:22
11/14/98-14:11:22 3 tDbgCmdTask 1220 informational : TIME/DATE updated

11/14/98-14:11:22 3 StrataCom 0 cnftime 14:11:22

excel.1.3.PXM.a >
```

cnftmzn

Use the **cnftmzn** command to configure the time zone for the switch.

Full Name

Configure Timezone

Card(s) on Which This Command Executes

PXM

Syntax

cnftmzn <timezone>

Syntax Description

<i>timezone</i>	Value to set timezone.
	1 = GMT
	2 = EST
	3 = CST
	4 = MST
	5 = PST

Related Commands

cnftime, **cnfdate**

Attributes

Log: Yes State: Active Privilege: SuperUser

Example 1-117 Configure the time zone in the node to U.S. Central Standard Time

```
excel.1.3.PXM.a > cnftmzn 3
excel.1.3.PXM.a >
```

cnftmzngmt

Use the **cnftmzngmt** command to configure the time zone for the shelf relative to GMT.

Full Name

Configure Timezone Relative to GMT

Card(s) on Which This Command Executes

PXM

Syntax

cnftmzngmt <*timeoffsetGMT*>

Syntax Description

timeoffsetGMT Number of offset in hours from GMT, in the range -12 to 12.

Related Commands

cnftmzn, **cnftime**, **cnfdate**

Attributes

Log: Yes State: Active Privilege: Superuser

Example 1-118 Set time zone in the shelf to GMT plus 4 hours

```
excel.1.3.PXM.a > cnftmzngmt 4
excel.1.3.PXM.a >
```

cnftrafficgen

Use the **cnftrafficgen** command to configure a traffic generation test. This test is used for troubleshooting cell loss and is intended for use with defective PVCs. This test is enabled or disabled at a connection level, not at a card level.

Software Version

Command available with 1.1.20 and higher.

Full Name

Configure Traffic Generation Test

Card(s) on Which This Command Executes

FRSM-VHS (2CT3/2T3/2E3/HS2)

Syntax

cnftrafficgen <pvc_num> <action> <num_frames> <pattern_type >

Syntax Description

pvc_num	A value in the following ranges: <ul style="list-style-type: none">• 16–4015 (2CT3)• 16–2015 (2T3/2E3/HS2)
action	One of the following actions: <ul style="list-style-type: none">• 1 = start• 2 = stop• 3 = abort
num_frames	A value in the range 1–40960000
pattern_type	A value in the range 1–4; default = 1

Related Commands

dspttrafficgen

Attributes

Log: No State: Active Privilege: Any

Example 1-119 Start traffic generation test on connection 16 for 100 frames with a pattern type of 1

```
spirit.1.1.VHS2CT3.a > cnftrafficgen 16 1 100 1
```

```
Wait.....  
Starting Test
```

Example 1-120 Stop traffic generation test on connection 16

```
spirit.1.1.VHS2CT3.a > cnftrafficgen 16 2
```

```
Wait....  
Stopping Test
```

cnftrapip

Use the **cnftrapip** command to configure the IP address to be used in all out-going traps from the shelf. This should be configured to one of the interface addresses. The system displays errors if they occur.

Full Name

Configure Trap IP Address

Card(s) on Which This Command Executes

PXM

Syntax

cnftrapip <ip_addr>

Syntax Description

ip_addr 32-bit IP address in dotted decimal format.

Related Commands

None

Attributes

Log: No State: Active Privilege: Any

Example 1-121

```
spirit4.1.8.PXM.a > cnftrapip 192.169.3.102
spirit4.1.8.PXM.a >
```

cnftrk

Use the **cnftrk** command to configure various trunk parameters. Execute this command after you have configured the interface as a routing trunk using the **cnfifastrk** command and activated the trunk on a node through the **addtrk** command.

Full Name

Configure Trunk

Card(s) on Which This Command Executes

PXM

Syntax

Note You can execute this command for only one optional (all but -slot.port) parameter at a time.

```
cnftrk -slot.port slot.port [-stres <Stats Reserve> | -ccRstr <CC Restrict> | -lnTyp <Line Type> |  
-passSync <yes/no> | -drtldly <Deroute Delay(ms)> | -fst <yes/no> |  
-fr <yes/no> | -nts <yes/no> | -ts <yes/no> | -voice <yes/no> | -cbr <yes/no> | -vbr <yes/no> |  
-abr <yes/no> | -rtcost <Routing Cost> | -vpconid <Max VPC Con IDs>
```

Syntax Description

<i>slot.port</i>	<ul style="list-style-type: none">• Slot = enter the value 7.• Port range= 1–n, as appropriate for the physical installation.
-stres	Command delineator that precedes the <i>Stats Reserve</i> entry.
<i>Stats Reserve</i>	Statistical reserve in cells per second, in the range 0–maximum bandwidth of the card.
-ccrstr	Command delineator that precedes the <i>CC Restrict</i> entry.
<i>CC Restrict</i>	Activates or deactivates the control plane communication restriction. <ul style="list-style-type: none">• yes = activate the restriction With this restriction, the switch avoids sending PAR control data over this trunk but does send control data if no other trunk is available.• no = allow PAR control communication
-lntyp	Command delineator that precedes the <i>Line Type</i> entry.
<i>Line Type</i>	Line type that characterizes the trunk. <ul style="list-style-type: none">• terrestrial• satellite
-passsync	Enable or disable the trunk to pass the synchronization clock. <ul style="list-style-type: none">• yes = enable the trunk to pass sync• no = disable
-drtdly	Command delineator that precedes the <i>Deroute Delay</i> entry.
<i>Deroute Delay</i>	Number of milliseconds the switch waits to deroute connections after a trunk failure occurs. The purpose of delaying connection deroute is that occasional, transitory trunk failures do not warrant the loss of service due to connection derouting.
-fst	Enable or disable ForeSight control. <ul style="list-style-type: none">• yes = enable• no = disable
-fr	Enable or disable Frame Relay traffic. <ul style="list-style-type: none">• yes = enable• no = disable
-nts	Enable or disable non-timestamped traffic. <ul style="list-style-type: none">• yes = enable• no = disable
-ts	Enable or disable timestamped traffic. <ul style="list-style-type: none">• yes = enable• no = disable

-voice	Enable or disable voice traffic. <ul style="list-style-type: none"> • yes = enable • no = disable
-cbr	Enable or disable constant bit rate traffic. <ul style="list-style-type: none"> • yes = enable • no = disable
-vbr	Enable or disable variable bit rate traffic. <ul style="list-style-type: none"> • yes = enable • no = disable
-abr	Enable or disable available bit rate traffic. <ul style="list-style-type: none"> • yes = enable • no = disable
-rtcost	Command delineator that precedes the <i>Routing_Cost</i> entry.
<i>Routing_Cost</i>	Routing cost for this trunk.
-vpconid	Command delineator that precedes the <i>Max VPC Con IDs</i> entry.
<i>Max VPC Con IDs</i>	Number of available Virtual Path Connection IDs for this trunk.

Related Commands

addtrk, dsptrks, dsptrcnf, dsptrkload

Attributes

Log: No State: Active Privilege: 2

Example 1-122

```
tangol.1.8.PXM.a > cnftrk 7.1-stres 1000 -ccrstr no -lntyp s -passsync yes -drtdly 0
-fst yes -fr yes -nts yes -ts yes -voice yes -cbr yes -vbr yes -abr yes -rtcost 10
-vpconid 255

tangol.1.8.PXM.a >
```

cnfupcabr

Use the **cnfupcabr** command to configure bandwidth control parameters for ABR connections on the current AUSM. No messages appear on-screen unless an error occurs.

Full Name

Configure Parameter Control for ABR

Card(s) on Which This Command Executes

PXM, AUSM-8T1/E1

Syntax for PXM

cnfupcabr <chan_num> <enable> <pcr[0+1]> <cdvt[0+1]> <scr> <scr_police> <mbs> <clp_tag>

Syntax Description

<i>chan_num</i>	Channel number, in the range 16–1015.
<i>enable</i>	Value to enable or disable UPC. <ul style="list-style-type: none"> • 1 = disable • 2 = enable
<i>pcr[0+1]</i>	Peak cell rate, in the range 1–38328 cells/second. This setting is the peak cell rate for cells with CLP = 0 and CLP = 1. The actual value depends on the speed of the logical port (which can be a T1, E1 (normal), E1 (clear), IMA T1, IMA E1 (normal) or an IMA E1 (clear) port). Note that the IMA port's speed is variable and depends on the number of links in the port.
<i>cdvt[0+1]</i>	Cell delay variation [0+1], in the range 1–250000 microseconds.
<i>scr</i>	Sustained cell rate, in the range 10–38328 cells per second. The actual value depends on the speed of the logical port (which can be a T1, E1 (normal), E1 (clear), IMA T1, IMA E1 (normal) or an IMA E1 (clear) port). Note that the IMA port's speed is variable and depends on the number of links in the port.
<i>scr_police</i>	Value to set SCR policing. <ul style="list-style-type: none"> • 1 = CLP[0] Cells • 2 = CLP[0+1] Cells • 3 = no SCR policing
<i>mbs</i>	Maximum burst size, in the range 1–5000 cells.
<i>clp_tag</i>	Enable or disable CLP tagging. <ul style="list-style-type: none"> • 1 = disable • 2 = enable

Syntax for AUSM-8T1E1

cnfupcabr <port.VPI.VCI | chan_num> <enable> <pcr[0+1]> <cdvt[0+1]> <scr> <scr_police>
<mbs> <clp_tag>

Syntax Description

<i>port.VPI.VCI</i>	<p>Port range = 1–n, as appropriate for the physical installation.</p> <p>VPI range = 1–4095.</p> <p>VCI range = 1–65535.</p>
<i>chan_num</i>	Channel number, in the range 16–1015.
<i>enable</i>	<p>Value to enable or disable UPC.</p> <ul style="list-style-type: none"> • 1 = disable • 2 = enable
<i>pcr[0+1]</i>	<p>Peak cell rate, in the range 10-38328 cells/second. This setting is the peak cell rate for cells with CLP = 0 and CLP = 1. The actual value depends on the speed of the logical port, which can be a T1, E1 (normal), E1 (clear), IMA T1, IMA E1 (normal) or an IMA E1 (clear) port.</p> <p>Note the following PCRs for a 10-PortRate:</p> <ul style="list-style-type: none"> • T1-3622 • E1-4528 • clearE1-4830 <p>Note the following PCRs for IMA:</p> <ul style="list-style-type: none"> • T1-3591 • E1-4490 • clrE1-4789 <p>Note that the IMA port's speed is variable and depends on the number of links in the port. Multiply the rate by the number of links.</p>
<i>cdvt[0+1]</i>	Cell delay variation [0+1], in the range 1–250000 microseconds.
<i>scr</i>	<p>Sustained cell rate, in the range 10–38328 cells per second. The actual value depends on the speed of the logical port, which can be a T1, E1 (normal), E1 (clear), IMA T1, IMA E1 (normal) or an IMA E1 (clear) port.</p> <p>Note that the IMA port's speed is variable and depends on the number of links in the port.</p>
<i>scr_police</i>	<p>Value to set SCR policing.</p> <ul style="list-style-type: none"> • 1 = CLP[0] Cells • 2 = CLP[0+1] Cells • 3 = no SCR policing
<i>mbs</i>	Maximum burst size, in the range 1–5000 cells.
<i>IngPcUtil</i>	<p>Ingress percentage utilization, in the range 1–127.</p> <p>Default = 0</p>

<i>EgSrvRate</i>	Egress service rate. Use the following values: <ul style="list-style-type: none"> • 1-PortRate (T1-3622, E1-4528, clearE1-4830) • IMA-T1-3591, E1-4490, clrE1-4789 <p>Note that the IMA port's speed is variable and depends on the number of links in the port. Multiply the rate by the number of links.</p>
<i>EgPcUtil</i>	Egress percentage utilization, in the range 1–127. Default = 0
<i>clp_tag</i>	Enable or disable CLP tagging. <ul style="list-style-type: none"> • 1 = disable • 2 = enable

Related Commands

dspcon, dspcons, cnfupccbr, cnfupcvbr

Attributes

Log: Yes State: Active Privilege: 1–2 (Any for PXM)

Example 1-123 Configuring bandwidth control parameters for ABR connections on the current AUSM (using the port.VPI.VCI argument)

```
s1.1.12.AUSMB8.a > cnfupcabr 2.1.5 2 3000 250000 2000 1 1000 50 4000 50 2
```

Example 1-124 Configuring bandwidth control parameters for ABR connections on the current AUSM (using the channel number argument)

```
s1.1.12.AUSMB8.a > cnfupcabr 31 2 3000 250000 2000 1 1000 50 4000 50 2
```

cnfupccbr

Use the **cnfupccbr** command to set connection bandwidth control parameters for the constant bit rate (CBR) connection type on the current AUSM.

No messages appear on-screen unless an error occurs.

Full Name

Configure User Parameter Control Constant Bit Rate

Card(s) on Which This Command Executes

PXM, AUSM

Syntax for PXM

cnfupccbr <chan_num> <enable|disable> <pcr[0+1]> <cdvt[0+1]> <pcr[0]> <cdvt[0]> <clp_tag>

Syntax Description

<i>chan_num</i>	A channel number in the range 16–1015.
<i>enable/disable</i>	Enable or disable UPC. <ul style="list-style-type: none"> • 1 = disable • 2 = enable
<i>pcr[0+1]</i>	Peak cell rate, in the range 10–38328 cells/second. This setting is the peak cell rate for cells with CLP = 0 and CLP = 1. The actual value depends on the speed of the logical port, which can be a T1, E1 (normal), E1 (clear), IMA T1, IMA E1 (normal), or an IMA E1 (clear) port. Note that the IMA port's speed is variable and depends on the number of links in the port.
<i>cdvt[0+1]</i>	Cell delay variation tolerance for cells with CLP = 0 and CLP = 1, in the range 1–250000 microseconds.
<i>pcr</i>	Peak cell rate in the range 10–38328 cells per second. The actual value depends on the speed of the logical port, which can be a T1, E1 (normal), E1 (clear), IMA T1, IMA E1 (normal) or an IMA E1 (clear) port. Note that the IMA port's speed is variable and depends on the number of links in the port.
<i>cdvt</i>	Cell delay variation tolerance for cells with CLP = 0, in the range 1–250000 microseconds.
<i>clp_tag</i>	Enable or disable CLP tagging. <ul style="list-style-type: none"> • 1 = disable • 2 = enable

Syntax for AUSM-8T1E1

cnfupccbr <port.VPI.VCI | ChanNum> <enable/disable> <pcr[0+1]> <cdvt[0+1]> <IngPcUtil>
<EgSrvRate> <EgPcUtil>

Syntax Description

- *port.VPI.VCI* Port range = 1–n, as appropriate for the physical installation.
VPI range = 1–4095.
VCI range = 1–65535.
- *ChanNum* Channel number, in the range 16–1015.
- *enable/disable* Enable or disable UPC.
 - 1 = disable
 - 2 = enable
- *pcr[0+1]* Peak cell rate, in the range 10-38328 cells/second. This setting is the peak cell rate for cells with CLP = 0 and CLP = 1. The actual value depends on the speed of the logical port, which can be a T1, E1 (normal), E1 (clear), IMA T1, IMA E1 (normal) or an IMA E1 (clear) port.
Note the following PCRs for a 10-PortRate:
 - T1-3622
 - E1-4528
 - clearE1-4830
 Note the following PCRs for IMA:
 - T1-3591
 - E1-4490
 - clrE1-4789
 Note that the IMA port's speed is variable and depends on the number of links in the port. Multiply the rate by the number of links.
- *cdvt[0+1]* Cell delay variation tolerance for cells with CLP = 0 and CLP = 1, in the range 1–250000 microseconds.
- *IngPcUtil* Ingress percentage utilization, in the range 1–127.
Default = 0
- *EgSrvRate* Egress service rate. Use the following values:
 - 1-PortRate (T1-3622, E1-4528, clearE1-4830)
 - IMA-T1-3591, E1-4490, clrE1-4789
 Note that the IMA port's speed is variable and depends on the number of links in the port. Multiply the rate by the number of links.
- *EgPcUtil* Egress percentage utilization, in the range 1–127.
Default = 0

Related Commands

dspcon, dspcons, cnfupcabr, cnfupcvbr

Attributes

Log: Yes State: Active Privilege: 1-2

Example 1-125 Set connection bandwidth control parameters for the constant bit rate (CBR) connection type on the current AUSM (using port.VPI.CVI argument)

```
s1.1.12.AUSMB8.a > cnfupccbr 2.1.1 2 4528 250000 50 4528 50
```

Example 1-126 Set connection bandwidth control parameters for the constant bit rate (CBR) connection type on the current AUSM (using channel number argument)

```
s1.1.12.AUSMB8.a > cnfupccbr 21 2 4528 250000 50 4528 50
```

cnfupcubr

Use the **cnfupcubr** command to configure the usage parameter control (UPC) parameters for unspecified bit rate (UBR) on the current AUSM8 card. No messages appear on-screen unless an error occurs.

Full Name

Configure User Parameter Control Unspecified Bit Rate

Card(s) on Which This Command Executes

PXM, AUSM-8T1E1

Syntax for PXM

cnfupcubr <chan_num> <enable> <pcr[0-1]> <cvdt[0-1]> <IngPcUtil> <clp_tag>

Syntax Description

<i>chan_num</i>	Channel number, in the range 16–1015.
<i>enable</i>	Enable or disable UPC. <ul style="list-style-type: none"> • 1 = disable • 2 = enable
<i>pcr[0-1]</i>	Peak cell rate, in the range 10–38328 cells/second. This setting is the peak cell rate for cells with CLP = 0 and CLP = 1. The actual value depends on the speed of the logical port, which can be a T1, E1 (normal), E1 (clear), IMA T1, IMA E1 (normal) or an IMA E1 (clear) port. Note that the IMA port's speed is variable and depends on the number of links in the port.
<i>cvdt[0-1]</i>	Cell delay variation, in the range of 1–250000 microseconds.
<i>IngPcUtil</i>	Ingress percentage utilization, in the range 1–100. Default = 0
<i>clp_tag</i>	Enable or disable CLP tagging. <ul style="list-style-type: none"> • 1 = disable • 2 = enable

Syntax for AUSM-8T1E1

cnfupcubr <port.VPI.VCI | chan_num> <enable> <pcr[0-1]> <cvdt[0-1]> <IngPcUtil> <clp_tag>

Syntax Description

<i>port.VPI.VCI</i>	<p>Port range = 1–<i>n</i>, as appropriate for the physical installation.</p> <p>VPI range = 1–4095.</p> <p>VCI range = 1–65535.</p>
<i>chan_num</i>	Channel number, in the range 16–1015.
<i>enable</i>	<p>Enable or disable UPC.</p> <ul style="list-style-type: none"> • 1 = disable • 2 = enable
<i>pcr[0+1]</i>	<p>Peak cell rate, in the range 10–38328 cells/second. This setting is the peak cell rate for cells with CLP = 0 and CLP = 1. The actual value depends on the speed of the logical port (which can be a T1, E1 (normal), E1 (clear), IMA T1, IMA E1 (normal) or an IMA E1 (clear) port).</p> <p>Note the following PCRs for a 10-PortRate:</p> <ul style="list-style-type: none"> • T1-3622 • E1-4528 • clearE1-4830 <p>Note the following PCRs for IMA:</p> <ul style="list-style-type: none"> • T1-3591 • E1-4490 • clrE1-4789 <p>Note that the IMA port's speed is variable and depends on the number of links in the port. Multiply the rate by the number of links.</p>
<i>cvdt[0–1]</i>	Cell delay variation, in the range of 1–250000 microseconds.
<i>IngPcUtil</i>	<p>Ingress percentage utilization, in the range 1–100.</p> <p>Default = 0</p>
<i>clp_tag</i>	<p>Enable or disable CLP tagging.</p> <ul style="list-style-type: none"> • 1 = disable • 2 = enable

Related Commands

dspcon, dspcons, cnfupcabr, cnfupcvbr

Attributes

Log: Yes State: Active Privilege: 1–2

Example 1-127 Configuring the usage parameter control (upc) parameters for unspecified bit rate (ubr) on the current AUSM8 card (using the port.VPI.VCI argument)

```
s1.1.12.AUSMB8.a > cnfupcubr 2.1.7 2 4528 250000 50 2
```

Example 1-128 Configuring the usage parameter control (upc) parameters for unspecified bit rate (ubr) on the current AUSM8 card (using the channel number argument)

```
s1.1.12.AUSMB8.a > cnfupcubr 37 2 4528 250000 50 2
```

cnfupcvbr

Use the **cnfupcvbr** command to configure channel bandwidth control parameters for a variable bit rate (VBR) connection type on the current AUSM. No messages appear on-screen unless an error occurs.

Full Name

Configure User Parameter Control Variable Bit Rate

Card(s) on Which This Command Executes

PXM, AUSM-8T1E1

Syntax for PXM

cnfupcvbr <chan_num> <enable> <pcr[0+1]> <cdvt[0+1]> <scr> <scr_police> <mbs> <clp_tag>

Syntax Description

<i>chan_num</i>	Channel number, in the range 16–1015.
<i>enable</i>	Enable or disable UPC. <ul style="list-style-type: none"> • 1 = disable • 2 = enable
<i>pcr</i> [0 + 1]	Peak cell rate for CLP [0+1] cells, in the range 10–38328 cells per second. The actual value depends on the speed of the logical port, which can be a T1, E1 (normal), E1 (clear), IMA T1, IMA E1 (normal) or an IMA E1 (clear) port. Note that the IMA port's speed is variable and depends on the number of links in the port.
<i>cdvt</i> [0 + 1]	Cell delay variation tolerance for cells with CLP = [0+1], in the range 1–250000 microseconds.
<i>scr</i>	Sustained cell rate, in the range 1–4670 cells per second.
<i>scr_police</i>	Value to set SCR policing. <ul style="list-style-type: none"> • 1 = CLP[0] cells • 2 = CLP[0+1] cells • 3 = no SCR policing
<i>mbs</i>	Maximum burst size, in the range 1–5000 cells.
<i>clp_tag</i>	Enable or disable CLP tagging. <ul style="list-style-type: none"> • 1 = disable • 2 = enable

Syntax for AUSM-8T1E1

cnfupcvbr <port.VPI.VCI | *chan_num*> <*enable*> <*pcr*[0+1]> <*cdvt*[0+1]> <*scr*> <*scr_police*> <*mbs*> <*IngPcUtil*> <*EgSrvRate*> <*EgPcUtil*> <*clp_tag*>

Syntax Description

<i>port.VPI.VCI</i>	<p>Port range = 1–n, as appropriate for the physical installation.</p> <p>VPI range = 1–4095.</p> <p>VCI range = 1–65535.</p>
<i>chan_num</i>	Channel number, in the range 16–1015.
<i>enable</i>	<p>Enable or disable UPC.</p> <ul style="list-style-type: none"> • 1 = disable • 2 = enable
<i>pcr[0+1]</i>	<p>Peak cell rate, in the range 10–38328 cells/second. This setting is the peak cell rate for cells with CLP = 0 and CLP = 1. The actual value depends on the speed of the logical port (which can be a T1, E1 (normal), E1 (clear), IMA T1, IMA E1 (normal) or an IMA E1 (clear) port).</p> <p>Note the following PCRs for a 10-PortRate:</p> <ul style="list-style-type: none"> • T1-3622 • E1-4528 • clearE1-4830 <p>Note the following PCRs for IMA:</p> <ul style="list-style-type: none"> • T1-3591 • E1-4490 • clrE1-4789 <p>Note that the IMA port's speed is variable and depends on the number of links in the port. Multiply the rate by the number of links.</p>
<i>cdvt [0+1]</i>	Cell delay variation tolerance for cells with CLP = [0+1], in the range 1–250000 microseconds.
<i>scr</i>	Sustained cell rate, in the range 1–4670 cells per second.
<i>scr_police</i>	<p>Value to set SCR policing.</p> <ul style="list-style-type: none"> • 1 = CLP[0] cells • 2 = CLP[0+1] cells • 3 = no SCR policing
<i>mbs</i>	Maximum burst size, in the range 1–5000 cells.
<i>IngPcUtil</i>	<p>Ingress percentage utilization, in the range 1–127.</p> <p>Default = 0</p>

EgSrvRate	Egress service rate. Use the following values: <ul style="list-style-type: none">• 1-PortRate (T1-3622, E1-4528, clearE1-4830)• IMA (T1-3591, E1-4490, clrE1-4789) Note that the IMA port's speed is variable and depends on the number of links in the port. Multiply the rate by the number of links.
EgPcUtil	Egress percentage utilization, in the range 1 to 127. Default = 0
<i>clp_tag</i>	Enable or disable CLP tagging. <ul style="list-style-type: none">• 1 = disable• 2 = enable

Related Commands

dspcon, dspcons, cnfupcabr, cnfupcbr

Attributes

Log: Yes State: Active Privilege: 1–2

Example 1-129 Configuring channel bandwidth control parameters for a variable bit rate (VBR) connection type on the current AUSM (using the port.VPI.VCI argument)

```
s1.1.12.AUSMB8.a > cnfupcvbr 2.1.3 2 3000 250000 2000 1 1000 50 4000 50 2
```

Example 1-130 Configuring channel bandwidth control parameters for a variable bit rate (VBR) connection type on the current AUSM (using the channel number argument)

```
s1.1.12.AUSMB8.a > cnfupcvbr 26 2 2 3000 250000 2000 1 1000 50 4000 50 2
```

cnfvismip

Use the **cnfvismip** command to configure the VISM IP address and the signaling unit (SU) IP address on the VISM card. An IP address for each VISM is necessary for it to communicate with the SU and serves as the identifier for VoIP endpoints. Together, the VISM IP address and the local RTP port identify the bearer channel of each VoIP connection.

Any of the above three parameters can be configured with the **cnfvismip** command. It is possible to configure all of them in a single command invocation or separate invocations. Once configured, these IP addresses will be stored on the hard disk on the PXM and will be retrieved from there for subsequent reboots of the card.

Note No automatic mechanism exists for communicating or registering the VISM IP address to the LightSpeed unit. Therefore, you must configure the signaling unit with the IP address of each CU that the SU controls.

Full Name

Configure VISM IP Address

Card(s) on Which This Command Executes

VISM

Syntax

cnfvismip -cuip <*VISM IP address*> | -mask <*net mask*> | -suip <*SU IP address*>

Syntax Description

-cuip	Command delineator that precedes the <i>VISM IP address</i> entry.
<i>VISM IP address</i>	32-bit IP address of the VISM in dotted decimal format.
-mask	Command delineator that precedes the <i>net mask</i> entry.
<i>net mask</i>	The network mask in the format <i>nnn.nnn.nnn.nnn</i> , where <i>n</i> = 0–9, and <i>nnn</i> < 256.
-suip	Command delineator that precedes the <i>SU IP address</i> entry.
<i>SU IP address</i>	32-bit IP address of the signaling unit, in dotted decimal format.

commit

Use the **commit** command to confirm copying the selected firmware file into the PXM.

Full Name

Confirm Copying the Firmware Load

Card(s) on Which This Command Executes

PXM

Syntax

commit <version>

Syntax Description

version Firmware version.

Related Commands

dspupgrade, rstupgrade, newrev, dspfwrevs, printrev, copy, install, abort

Attributes

Log: Yes State: Active Privilege: Any

Example 1-131 Loading firmware 1.1.10

```
NODENAME.1.8.PXM.a > commit 1.1.10
this may take a while ...
commit command completed ok
```

Example 1-132 Commit command errors (multiple cases)

```
NODENAME.1.8.PXM.a > commit 1.1.11
in 'upgrade idle', must be in 'upgrade newrev'
ERR: command "commit" failed

NODENAME.1.7.PXM.a > commit 1.1.11
1.1.11 is not the currently running version 1.1.10Hu
ERR: command "commit" failed
```

Example 1-133 Loading firmware on a Service Module

```
golden1.1.7.PXM.a > commit sm 11 10.0.05
Do you want to proceed (Yes/No)? yes
```

Example 1-134 Errors loading firmware on a Service Module

```
golden1.1.7.PXM.a > commit sm 11 10.0.04
```

```
Incorrect version : 10.0.04  
usage: commit [sm <slot>] <version>  
ERR: command "commit" failed
```

copy

Use the **copy** command to replicate the selected firmware file into the PXM.

Full Name

Copy the Firmware Load

Card(s) on Which This Command Executes

PXM

Syntax

copy <fw_load>

Syntax Description

fw_load Firmware file name.

Related Commands

abort, commit, cp

Attributes

Log: No State: Any Privilege: Any

Example 1-135 Copy loading firmware file named pxm_1.0.00Ef.fw

```
spirit4.1.8.PXM.a > copy pxm_1.0.00Ef.fw
spirit4.1.8.PXM.a >
```

cp

Use the **cp** command to replicate the selected firmware file into the PXM.

Full Name

Copy the firmware load

Card(s) on Which This Command Executes

PXM

Syntax

copy <fw_load>

Syntax Description

fw_load Firmware file name.

Related Commands

abort, commit, copy

Attributes

Log: No State: Any Privilege: Any

Example 1-136 Copy loading firmware file named pxm_1.0.00Ef.fw

```
spirit4.1.8.PXM.a > copy pxm_1.0.00Ef.fw
spirit4.1.8.PXM.a >
```

cth

Use the **cth** command to clear the transaction handler trace buffer.

Full Name

Clear Transaction Handler

Card(s) on Which This Command Executes

PXM

Syntax

cth

Related Commands

thtrace, dth

Attributes

Log: No

State: Any

Privilege: Service Group

Example 1-137

```
spirit4.1.1.8.PXM.a > cth  
spirit4.1.1.8.PXM.a >
```

copychans

Use the **copychans** command copy a channel configuration onto one or more channels. This command enables you to create and configure multiple channels from a specified “template” channel.

Full Name

Copy Channels

Card(s) on Which This Command Executes

FRSM, AUSM

Syntax

copychans <template chan #> <start chan #> <start dlcI> <# of chans> <start remote VPI> <start remote VCI>

Syntax Description

<i>template chan #</i>	<p>Template channel number, in the range appropriate for the card.</p> <ul style="list-style-type: none"> • FRSM <ul style="list-style-type: none"> — 8T1/E1 range = 16–1015 — T3/E3/HS2 range = 16–2015 — 2CT3 range = 16–4015 • AUSM range = 16–1015
<i>start chan #</i>	<p>Start channel number, in the range appropriate for the card.</p> <ul style="list-style-type: none"> • FRSM • 8T1/E1 range = 16–1015 • T3/E3/HS2 range = 16–2015 • 2CT3 range = 16–4015 • AUSM range = 16–1015
<i>start dlcI</i>	<p>Start local DLCI for FRSM</p> <p>Start local VCI for AUSM</p>
<i># of chans</i>	Number of channels.
<i>start remote VPI</i>	
<i>start remote VCI</i>	

Related Commands

delchan, delchans

Attributes

Log: No

State: Active

Privilege: 1

copyports

Use the **copyports** command to copy a port configuration to one or more ports. The purpose of this command is to create and configure multiple ports from a single port that serves as a template.

Full Name

Copy Ports

Card(s) on Which This Command Executes

FRSM (not on the HS1/B)

Syntax

copyports <template port #> <start port #> <start time slot> <# of ports>

Syntax Description

<i>template port #</i>	Template port number. This setting is the number of the template port to be copied.
<i>start port #</i>	Start port number. This setting is the number of the port to be copied.
<i>start time slot</i>	Start time slot. This setting is the starting time slot in the port to be copied.
<i># of ports</i>	Number of ports. This setting is the number of contiguous time slots to be copied.

Related Commands

delport, delports

Attributes

Log: NoState: ActivePrivilege: 1

cvsi

Use the **cvsi** command to clear the VSI trace buffer.

Full Name

Clear VSI

Card(s) on Which This Command Executes

PXM

Syntax

cvsi

Related Commands

vsitrace, dvti

Attributes

Log: No

State: Any

Privilege: Cisco Group

Example 1-138 Clear VSI on the current PXM

```
spirit4.1.1.8.PXM.a > cvsi  
spirit4.1.1.8.PXM.a >
```

dcct

Use the **dcct** command to display connection information.

Full Name

Display Connection

Card(s) on Which This Command Executes

PXM

Syntax

dcct <*slot.port.vpi.vci*>

Syntax Description

- slot.port.vpi.vci*
- Slot range = 1–32
 - Port range = 1–256
 - VPI range = 0–4095
 - VCI range = 0–65535

Related Commands

None

Attributes

Log: No State: Active Privilege: Service Group

Example 1-139 Example: Show connection information for the card in slot 2

```
porky.1.7.PXM.a > dcct 6.2.100.100
Connection does not exist

porky.1.7.PXM.a >
```

dcondb

Use the **dcondb** command to view a connection database.

Full Name

Display Connection Database

Card(s) on Which This Command Executes

PXM

Syntax

dcondb <dbtype> <index>

Syntax Description

<i>dbtype</i>	Value to set the <ul style="list-style-type: none">• 1 = master• 2 = slave• 3 = DAX• 4 = Summary
<i>index</i>	Set index for either index or dbtype.

Related Commands

None

Attributes

Log: No State: Any Privilege: Service Group

del

Use the **del** command to remove a file or directory from the PXM hard drive.

Full Name

Delete

Card(s) on Which This Command Executes

PXM

Syntax

del <*path_name*>

Syntax Description

path_name Name of an existing file or directory.

Related Commands

None

Attributes

Log: Yes

State: Any

Privilege: Service Group

delaimgrp

Use the **delaimgrp** command to delete an AIMUX group.

Full Name

Delete AIMUX Group

Card(s) on Which This Command Executes

AUSM

Syntax

delaimgrp <group_num>

Syntax Description

group_num AIMUX group number to be deleted, in the range 1–8.

Related Commands

addaimgrp, cnfaimgrps, dspaimgrp, dspaimgrps

Attributes

Log: Yes State: Active Privilege: 1–2

Example 1-140 Delete AIMUX group 2 on the current AUSM card

```
spirit3.1.22.AUSM8.a > delaimpgrp 2
spirit3.1.22.AUSM8.a >
```

delapsln

Use the **delapsln** command to delete an APS line configuration.

Full Name

Delete APS Line

Card(s) on Which This Command Executes

PXM

Syntax

delapsln <*workingline*>

Syntax Description

workingline The configured working line on the PXM.

Related Commands

addapsln, cnfapsln, dspapsln, switchapsln

Attributes

Log: Yes State: Active Privilege: SUPER_GP

delbert

Use the **delbert** command to conclude a BERT testing session in a specified location on the shelf.

Full Name

Delete BERT

Card(s) on Which This Command Executes

PXM

Syntax

delbert <slot>

Syntax Description

slot Slot number, as configured for BERT testing.

Related Commands

cnfbert, dspbert, modbert, xcfnfbert

Attributes

Log: Yes State: Active Privilege: GROUP_1

delcdrsoprtn

Use the **delcdrsoprtn** command to delete GLCNs allocated to a controller. This command applies if the card partition type is *controllerBased*.

Full Name

Delete Card Resource Partition

Card(s) on Which This Command Executes

PXM, FRSM, AUSM, CESH, VISM

Syntax

delcdrsoprtn <controller-name>

Syntax Description

controller-name Value to set controller type.

- 1 = PAR/PVC
- 2 = PNNI/SPVC
- 3 = TAG

Related Commands

addcdrsoprtn, cnfcdrsoprtn, dspcdrsoprtn

Attributes

Log: Yes

State: Any

Privilege: SERVICE_GP

Example 1-141 Delete the allotment of connections on the current card for the Tag controller

```
spirit4.1.8.PXM.a > delcdrsoprtn 3
spirit4.1.8.PXM.a >
```

delchan

Use the **delchan** command to delete a channel. After you finish this command, no messages appear on-screen unless the command cannot execute as entered.

Full Name

Delete Channel

Card(s) on Which This Command Executes

PXM, FRSM, AUSM, CESH

Syntax

delchan <channel number>

Syntax Description

channel number Channel number, as appropriate for the card.

- PXM range = 16–4111
- FRSM range = 16–1015
- CESH
 - T1/E1 range = 32–279
 - T3/E3 = enter the value 32

Related Commands

dspchan, addchan, cnfchan

Attributes

Log: Yes State: Any Privilege: Any

delchanloop

Use the **delchanloop** command to delete a channel loopback from the current FRSM or AUSM.

No messages appear on-screen after command entry unless the command cannot execute as entered.

Full Name

Delete a Channel Loopback

Card(s) on Which This Command Executes

FRSM, AUSM

Syntax: FRSM

delchanloop <*chan_num*>

Syntax Description

chan_num Channel number, in the range appropriate for the card.

- FRSM
 - 8T1/E1 range = 16–1015
 - T3/E3/HS2 range = 16–2015
 - HS1/B range = 16–1015
 - 2CT3 range = 16–4015

Related Commands

addchanloop, **tstcon**, **tstdelay**

Attributes

Log: Yes State: Active Privilege: 1–4

Syntax for AUSM-8T1E1

delchanloop <*port.VPI.VCI* | *ChanNum*>

Syntax Description

port.VPI.VCI Port range = 1–n, as appropriate for the physical installation.
VPI range = 1–4095.
VCI range = 1–65535.

ChanNum Channel number, in the range 16–1015.

Related Commands

addchanloop, tstcon, tstdelay

Attributes

Log: Yes State: Active Privilege: 1–4

Example 1-142 Delete channel loopback on a channel number for the current AUSM

```
s1.1.12.AUSMB8.a > delchanloop 26
```

Example 1-143 Delete channel loopback on port 2, VPI 1, VCI 3 on the current AUSM

```
s1.1.12.AUSMB8.a > delchanloop 2.1.3
```

delchans

Use the **delchans** command to delete a range of Frame Relay or ATM channels.

Full Name

Delete Channels

Card(s) on Which This Command Executes

FRSM, AUSM

Syntax

delchans <*start chan #*> <*# of chans*>

Syntax Description

start chan # Start channel number, in the range appropriate for the card.

- FRSM
 - 8T1/E1 range = 16–1015
 - T3/E3/HS2 range = 16–2015
 - HS1/B range = 16–1015
 - 2CT3 range = 16–4015
- AUSM range = 16–1015

of chans Number of channels to delete.

Related Commands

None

Attributes

Log: No State: Active Privilege: 1

delcon

Use the **delcon** command to remove a connection from the AUSM or VISM card.

Full Name

Delete Connection

Card(s) on Which This Command Executes

PXM, FRSM, CESM, AUSM

Syntax: PXM, CESM

delcon <conn_ID>

Syntax Description

conn_ID Connection number, as appropriate for the card.

- PXM = enter values in the format *PortNo.VPI.VCI*.
- CESM
 - T1 range = 1–192
 - E1 range = 1–248

Syntax: FRSM,

delcon <port.DLCI>

Syntax Description

port.DLCI Connection number, in the format *port.DLCI*.

Syntax: AUSM

delcon <port.VPI.VCI>

Syntax Description

port.VPI.VCI Connection number, in the format *port.VPI.VCI*.

Related Commands

addcon, dspcons, dspcon

Attributes

Log: Yes State: Active Privilege: 1–2

deldsx3bert

Use the **deldsx3bert** command to end the current test. Value in the BERT counters will remain until you use the **clrbertcntrs** command.

Full Name

Delete DSX3 BERT

Card(s) on Which This Command Executes

FRSM 2T3E3, CESMT3

Syntax: PXM, CESM, AUSM

deldsx3bert

Related Commands

acqdsx3bert, clrbertcntrs, cnfdsx3bert, dspdsx3bert, moddsx3bert, startdsx3bert

Attributes

Log: No State: Active Privilege: Any

Example 1-144 Stop the current BERT session

```
popeye1.1.21.CESMT3.a > deldsx3bert
popeye1.1.21.CESMT3.a >
```

Example 1-145 Display results

```
popeye1.1.21.CESMT3.a > dspdsx3bert

Bert Control:                               Default state
Bert Resource Status State:                 Free
Bert Owner:                                 CLI
Bert Status:                                Inactive
Bert Test Medium:                           Line
Bert Port:                                  1
Line Number :                               1
Bert Mode :                                  bertPatternTest
Bert Pattern :                               allOnes
Loopback type:                               No loopback
Start time (secs.):                          Not Configured Yet
Start Date                                   Not Configured Yet
Bit countupper:                              80
Bit countlower:                              1054968191
Bit Error Countupper                          0
Bit Error Countlower                          1655197832
Error Insertion Rate:                         Error injection disabled
Error Insertion count:                       0
```

DSX3 BERT in Sync

```
popeye1.1.21.CESMT3.a >
```

delifip

Use the **delifip** command to delete a management interface, clearing the database information.

Full Name

Delete a Management Interface

Card(s) on Which This Command Executes

PXM

Syntax

delifip <Interface>

Syntax Description

<i>Interface</i>	Value to set the interface type. <ul style="list-style-type: none">• 26 = Ethernet• 28 = SLIP• 37= ATM
------------------	--

Related Commands

cnfifip, dspifip

Attributes

Log: Yes State: Any Privilege: SuperUser

Example 1-146 Delete the ATM interface (indicated by the number 37)

```
spirit1.1.8.PXM.a > delifip 37  
spirit1.1.8.PXM.a >
```

dellink

Use the **dellink** command to remove a link between a T1 line within a T3 line on an SRM-3T3 card and a slot and line number on a service module.

Full Name

Delete Link

Card(s) on Which This Command Executes

PXM

Syntax

dellink <T3 line number> <T1 line number>

Syntax Description

T3 line number SRM-3T3 T3 line number in the format *slot.port*.

- slot = enter the value 15 or 31
- line range = 1-3

T1 line number Starting T1 line number, in the range 1–28.

Related Commands

dsplink, addlink

Attributes

Log: No

State: Active

Privilege: Any

Example 1-147 Delete the link between the first T3 line on the SRM-T3 in slot 15 and T1 line 1

```
spirit1.1.8.PXM.a > dellink 15.1 1
spirit1.1.8.PXM.a >
```

dellmiloop

Use the **dellmiloop** command to delete a current local management interface (LMI) configuration and resume sending LMI connection status messages to the BPX feeder trunk. This command should be used in conjunction with the **delfdrp** command on the BPX module. You first should use **dellmiloop** on the MGX 8800 series switch, then use **delfdrp** on the BPX module. Be aware that there is no display command for the feeder loop on the BPX.

Use the **dspmistats** command after you have executed the **dellmiloop** command on the MGX 8800 switch and the **delfdrp** command on the BPX module to verify the delete commands. The LMI statistics table will show an increase in statistics.

Figure 1-5 Status Messages Halted between a MGX 8800 Series Switch and a BPX Switch, then Enabled again Using dellmiloop and delfdrp

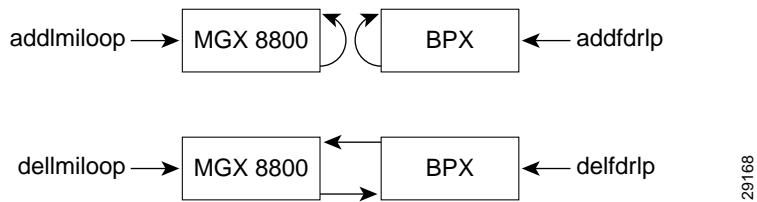

Full Name

Delete LMI Loop

Card(s) on Which This Command Executes

PXM

Syntax

dellmiloop <slot.port>

Syntax Description

- slot.port* A value, where:
- slot = slot number, in the range 1–32
 - port = port number, in the range 1–256

Related Commands

cnfilmi, dspilmi, dspilmicnt, dspilmis, addmiloop, delfdrp

Attributes

Log: No State: Active Privilege: Super Group (0)

The examples that follow illustrate:

- 1 The delete feeder trunk command executed on the BPX.
- 2 The display LMI loop command, indicating that an LMI loop exists.
- 3 The delete LMI loop command, terminating the LMI loop.

Example 1-148 Delete feeder loop on the BPX

```
delfdr1p 5.5
```

Example 1-149 Display LMI loop (LMI loop added)

```
NODENAME.1.7.PXM.a > dsplmiloop
TRK      IN LMI LOOP
-----
7.1      Yes
```

Example 1-150 Delete LMI loop

```
NODENAME.1.7.PXM.a > dellmiloop 7.1
```

Example 1-151 Display LMI loop (LMI loop deleted)

```
NODENAME.1.7.PXM.a > dsplmiloop
TRK      IN LMI LOOP
-----
7.1      No
```

delln

Use the **delln** command to remove a line from the current card.

Full Name

Delete Line

Card(s) on Which This Command Executes

PXM, FRSM, AUSM (8T1/E1;IMATM-T3T1/E3E1), CESM, VISM

Syntax

delln <LineNum>

or

delln <-ds3 | -e3 | -sonet> <LineNum>

(on the PXM)

Syntax Description

LineNum Line number, as appropriate for the card.

- FRSM range = 1–4
- AUSM range = 1–8
- CESM range = 1–8
- VISM range = 1–8

-ds3 Command delineator that precedes ds3 line number entry.

-e3 Command delineator that precedes E3 line number entry.

-sonet Command delineator that precedes SONET line number entry.

Note Set line number value at 7 if the line type is SONET.

Related Commands

dspln, addln, cnfln

Attributes

Log: Yes State: Active Privilege: 1

Example 1-152 Delete line 4 from the current card

```
spirit1.1.8.PXM.a > delln 4
spirit1.1.8.PXM.a >
```

delnloop

Use the **delnloop** command to remove a T1 or E1 line loopback state for the current card.

Full Name

Delete Line Loop

Card(s) on Which This Command Executes

PXM, AUSM, FRSM, CESM, VISM

Syntax

delnloop -ds3 | -e3 | -sonet <*line number*>

Syntax Description

line number DS3 or E3: Line number for ds3 or e3 in the format *slot.port*.

- Slot = enter a value from the range 7, 8, 15, 16, 31, or 32
- Line range = 1 to *n*

SONET: Line number in the format *slot.port*

- Slot = enter the value either 7 or 8
- Line range = 1 to *n*

Related Commands

addnloop

Attributes

Log: No (Yes PXM) State: Active Privilege: -1 (Service) (Any on PXM)

dellnsfmaimgrp

Use the **dellnsfmaimgrp** command to remove lines from an existing AIMUX group.

Full Name

Delete Lines from an AIM Group

Card(s) on Which This Command Executes

AUSM

Syntax

dellnsfmaimgrp <aimux_grp> <list_of_lines>

Syntax Description

aimux_grp AIMUX group number, in the range 1–8.

list_of_lines List of lines to be deleted from the AIMUX group. Type a dot between each group number in your entry string.

Related Commands

addlns2aimgrp

Attributes

Log: Yes State: Active Privilege: 1–2

Example 1-153 Delete lines 3 and 5 from AIMUX group 2

```
spirit1.1.8.PXM.a > dellnsfmaimgrp 2 3.5
spirit1.1.8.PXM.a >
```

delport

Use the **delport** command to remove a port from an FRSM, a PXM, or a CESM.

Full Name

Delete Port

Card(s) on Which This Command Executes

PXM, FRSM, CESM

Syntax: PXM

delport <port-number>

Syntax Description

port-number Number of the port to be deleted.

Syntax: FRSM, CESM

delport <port_num>

Syntax Description

port_num Number of the port to be deleted.

Related Commands

addport, cnfport, dspport, dspports

Attributes

Log: Yes State: Active Privilege: 1

delports

Use the **delports** command remove a specified number of contiguous port configurations.

No messages appear on-screen with successful completion of this command.

Full Name

Delete Ports

Card(s) on Which This Command Executes

FRSM, CESM

Syntax

delports <start port #> <# of ports>

Syntax Description

start port # Start port number to be deleted.

of ports Number of contiguous time slots to be deleted.

Related Commands

copyports

Attributes

Log: No State: Active Privilege: 1

delred

Use the **delred** command to remove a redundancy link for the specified primary card slot.

Full Name

Delete Redundancy

Card(s) on Which This Command Executes

PXM

Syntax

delred <*redPrimarySlotNumber*>

Syntax Description

redPrimarySlotNumber Slot number of the primary card of the card pair, in the ranges 1–6, or 9–14, or 17–22, or 25–30.

Related Commands

dspre, **addred**

Attributes

Log: No

State: Active

Privilege: Any

delrsprtn

Use the **delrsprtn** command to remove a resource partition. Refer to the description of **addrsptrtn** for information on resource partitions.

Full Name

Delete Resource Partition

Card(s) on Which This Command Executes

PXM, FRSM (not on HS1/B)

Syntax

delrsprtn <if_num> <ctrlr_num>

Syntax Description

if_num Interface Number, in the range 1–32.

ctrlr_num Value to set controller number.

- 1 = PAR
- 2 = PNNI
- 3 = TAG

Related Commands

addrsptrtn

Attributes

Log: No

State: Any

Privilege: Any

delslotlink

Use the **delslotlink** command to remove SRM-3T3 link information for a specified slot.

Full Name

Delete Slot Link

Card(s) on Which This Command Executes

PXM

Syntax

delslotlink <slot number> <line number>

Syntax Description

slot number Slot number associated with the link to be deleted.

line number Line number associated with the link to be deleted, in the range 1-*n*, as appropriate for the physical installation.

0 = unlink all lines

Related Commands

dpslotlink

Attributes

Log: No

State: Active

Privilege: Any

deltrapmgr

Use the **deltrapmgr** to delete the specified trap manager associated with the specified IP address.

Full Name

Delete Trap Manager

Card(s) on Which This Command Executes

PXM

Syntax

deltrapmgr <ipaddr>

Syntax Description

ipaddr 32-bit IP address of the trap manager to delete, in dotted decimal format.

Related Commands

addtrapmgr, dsptrapmgr, dsptrapmgrs

Attributes

Log: Yes State: Active Privilege: SuperUser

deltree

Use the **deltree** command to remove a directory and all files below.

Full Name

Delete Tree

Card(s) on Which This Command Executes

PXM

Syntax

deltree <*path_name*>

Syntax Description

path_name Name of an existing file or directory.

Related Commands

None

Attributes

Log: Yes State: Any Privilege: SUPER_GP

deluser

Use the **deluser** command to remove a user from the list of users on the node of an MGX 8800 series switch. The system does not allow you to delete a user with a privilege level higher than the level at which you execute the command. For example, if the current user privilege is 2, you cannot delete a user at level 1. No screen output appears unless an error occurs.

Full Name

Delete User

Card(s) on Which This Command Executes

PXM

Syntax

deluser <*user ID*>

Syntax Description

user ID User name, consisting of up to 12 characters.

Related Commands

dspusers, adduser

Attributes

Log: Yes State: Active Privilege: 1–5

dir

Use the **dir** command to view the firmware files on the PXM.

Full Name

Directory

Card(s) on Which This Command Executes

PXM

Syntax

dir

Related Commands

mkdir, rmdir

Attributes

Log: No

State: Any

Privilege: Any

Example 1-154 List the firmware on the current PXM

```
raviraj.1.7.PXM.a > dir
  size      date      time      name
  -----
    512     JUL-03-1999  19:20:44  .           <DIR>
    512     JUL-03-1999  19:20:44  ..          <DIR>
 2089064    JUL-03-1999  13:54:08  pxm_rmenon.old.fw
   896020   JUL-18-1999  14:18:50  sm130.fw
   794280   JUL-03-1999  14:56:42  sm35.fw
  1136684   JUL-03-1999  16:04:50  sm50.fw
  2094828   JUL-16-1999  14:29:06  pxm_rmenon.fw
```

```
In the file system :
  total space : 819200 K bytes
  free space  : 742625 K bytes
```

```
raviraj.1.7.PXM.a >
```

dlmi

Use the **dlmi** command to display the data captured as a result of executing the **lmitrace** command. You first must use the **lmitrace** command to capture the data, then the **dlmi** command to display the data.

Full Name

Display LMI trace

Card(s) on Which This Command Executes

PXM

Syntax

dlmi

Related Commands

lmitrace (to capture lmi messages) **clmi** (to clear lmi buffer)

Attributes

Log: No

State: Any_State

Privilege: Cisco_Gp

Example 1-155 Display when the LMI trace buffer is empty

```
NODENAME.1.8.PXM.a > dlmi
LMI Trace Buffer is empty
```

Example 1-156 Display when the LMI trace buffer contains data (resulting from the lmitrace command)

```
NODENAME.1.8.PXM.a > dlmi
No. Time(mSecs) AbsTime Ltrk Dir MsgType Length Data
0 0 171519360 1 Rx 76 28
[ 09 03 ff ff ff 76 80 00 13 66 80 00 01 04 5a 80 00 05 80 00 03 00 1f 64 80 00 01 d3
]
1 0 171519360 1 Tx 7e 32
[ 09 03 ff ff ff 7e 80 00 13 66 80 00 01 04 65 80 00 05 00 03 00 1f 82 64 80 00 01 d3
0d 00
00 00 ]
2 +26 171519880 1 Tx 76 32
[ 09 03 ff ff ff 76 80 00 13 66 80 00 01 04 5a 80 00 05 80 00 03 00 1f 64 80 00 01 1b
0d 00
00 00 ]
```

dnif

Use the **dnif** command to deactivate the specified broadband interface.

Note For a user-port, you must remove all UNI channels on the interface before you deactivate the port.

Full Name

Down Interface

Card(s) on Which This Command Executes

PXM

Syntax

dnif <*if_num*>

Syntax Description

if_num Interface number, in the range 1–32.

Related Commands

cnfif, dspif, upif

Attributes

Log: No State: Active Privilege: 1

dnilmi

Use the **dnilmi** command to deactivate the Integrated Local Management Interface (ILMI) on a specified PXM port number.

Full Name

Down ILMI

Card(s) on Which This Command Executes

PXM

Syntax

dnilmi -ifNum *<bbIfSigPortNum>*

Syntax Description

-ifNum Command delineator that precedes the *bbIfSigPortNum* entry.

bbIfSigPortNum Broadband interface signal port number, in the range 1–32.

Related Commands

cnfilmi, dspilmi, dspilmicnt, dspilmis, upilmi

Attributes

Log: No

State: Any

Privilege: CISCO_GP

downloadflash

Use the **downloadflash** command to load the first boot code found by the PXM hard drive into EEPROM (flash memory). A downloadflash session concludes the sequence of tasks for performing a PXM boot code load. Prior to executing the **downloadflash** command, you must access the boot code, transfer the file (using a “put” command) to the PXM hard drive.

Using various arguments with the “put” command enables boot code load unto both the standby and active PXM, or to the active PXM only, or to the standby PXM only. Details are provided in the example below.

Note Make sure only one backup boot code resides in the firmware directory: either delete or rename old versions to ensure the downloadflash session does not pick up the wrong version.

Once firmware is installed in slot 7, the firmware file is mirrored to a PXM subsequently installed in slot 8. For safe measure, however, you should manually download the boot code (using the **downloadflash** command onto the standby PXM.

Full Name

Download the Flash

Card(s) on Which This Command Executes

PXM

Syntax

downloadflash

Related Commands

Attributes

Log: No State: Any Privilege: SUPER_GP

Example 1-157 Example: Do a PXM boot code load, starting with a TFTP to the boot code source, and ending with the download to the standby and the active PXM.

```
tftp <dest_addr> (of the switch)
bin
put pxm_bkup_version>.fw POPEYE@PXM.BT
quit
wilco.1.7.PXM.a > downloadflash
```

Note Despite the potentially deceptive “.fw” argument in the command string, this is NOT a firmware load.

- To place the boot code on the active PXM only, use the following “put” string:

```
put pxm_bkup_version>.fw POPEYE@PXM_ACTIVE.BT
```
- To place the boot code on the standby PXM only, use the following “put” string:

```
put pxm_bkup_version>.fw POPEYE@PXM_STANDBY.BT
```

dnport

Use the **dnport** command to deactivate a port.

Full Name

Down Port

Card(s) on Which This Command Executes

FRSM, AUSM

Syntax

dnport <*PortNum*>

Syntax Description

PortNum Port number, in the range 1–*n*, as appropriate for the card.

Related Commands

upport

Attributes

Log: No State: Active Privilege: 1

dspaimgrp

Use the **dspaimgrp** command to view detailed status and configuration information for a specified AIMUX group.

Full Name

Display AIM Group Status and Configuration

Card(s) on Which This Command Executes

AUSM

Syntax

dspaimgrp *<imagroup_number>*

Syntax Description

imagroup_number AIMUX group number, in the range 1–8.

Related Commands

addaimgrp, delaimgrp, cnfaimgrps, dspaimgrps

Attributes

Log: Yes State: Active Privilege: 1–2

Example 1-158 Display all the detailed status and configuration information for AIMUX group 1 on the current card.

```
spirit.1.19.AUSM8.a > dspaimgrp 1

IMA Group number           : 1
Port type                  : NNI
Lines configured           : 1.2.3
Enable                     : Enabled
IMA Port state             : Sig. Failure
IMA Group Ne state        : Startup
PortSpeed (cells/sec)     : 13470
GroupTxAvailCellRate (cells/sec) : 0
ImaGroupTxFrameLength(cells) : 128
LcpDelayTolerance (IMA frames) : 1
ReadPtrWrPtrDiff (cells)  : 4
Minimum number of links   : 2
MaxTolerableDiffDelay (msec) : 200
Lines Present             :
ImaGroupRxImaId           : 0x100
ImaGroupTxImaId           : 0x0
Observed Diff delay (msec) : 0
Clock Mode                : CTC
GroupAlpha                 : 2
GroupBeta                  : 2
GroupGamma                 : 1
Type <CR> to continue, Q<CR> to stop:

GroupConfiguration        : 1
IMAGrp Failure status    : Ne StartUp
Timing reference link     : 1

Syntax : dspimagrp (or dspaimgrp) "imagroup_number"
        IMA group number -- value ranging from 1 to 8

spirit.1.19.AUSM8.a >
```

dspaimgrpct

Use the **dspaimgrpct** command to view all AIMUX related counters for a line in an AIMUX group.

Full Name

Display AIM Group Count

Card(s) on Which This Command Executes

AUSM

Syntax

dspaimgrpct <imagroup>

Syntax Description

imagroup AIMUX group number, in the range 1–8.

Related Commands

clraimgrpct

Attributes

Log: Yes State: Active Privilege: 1–2

Example 1-159 Display all the AIMUX related counters for AIMUX group 1 on the current card

```
spirit.1.19.AUSM8.a > dspaimgrpct 1

IMA Group number:                1
Ne Number of failures             : 0

Syntax : dspimagrpt (or dspaimgrpct) imagroup
        IMA group number -- value ranging from 1 to 8

spirit.1.19.AUSM8.a >
```

dspaimgrps

Use the **dspaimgrps** command to view the status and configuration information for all current AIMUX groups.

Full Name

Display Status and Configuration of All AIM Groups

Card(s) on Which This Command Executes

AUSM

Syntax

dspaimgrps

Related Commands

addaimgrp, delaimgrp, cnfaimgrps, dspaimgrp

Attributes

Log: Yes State: Active Privilege: 1-2

Example 1-160 Display the status and configuration information for all AIMUX groups on the current card

```
spirit.1.19.AUSM8.a > dspaimgrps

List of IMA groups:
=====

ImaGrp PortType Speed Lines configured Lines present Tol Diff Port State
-----
19.1 NNI 13470 1.2.3 200 Sig. Failure

NextPortNumAvailable: 6
Syntax : dspimagrps (or dspaimgrps)

spirit.1.19.AUSM8.a >
```

dspaimlncnt

Use the **dspaimlncnt** command to view all the AIMUX line counters for the specified line in an IMA trunk.

Full Name

Display AIM (or Display IMA) Line Count

Card(s) on Which This Command Executes

AUSM

Syntax

dspaimlncnt *<imagroup>* *<linenum>*

Syntax Description

imagroup AIMUX group number, in the range 1–8.

linenum AIMUX line number, in the range 1–8.

Related Commands

clraimlncnt, clrimalncnt, dspimalncnt

Attributes

Log: No State: Active Privilege: 1

Example 1-161 Display the line counters for line 1 of IMA group 1

```
spirit.1.19.AUSM8.a > dspaimlncnt 1 1

IMA group number           : 1
Line number                : 1
Acp Cells Received         : 0
Acp Errored Cells Recvd   : 0
Port changed from LDS      : 0
# HEC errored cells        : 0
# HEC errored seconds      : 0
# Severely HEC errored seconds : 0

Syntax : dspimalncnt (or dspaimlncnt) imagroup linenum
        IMA group number -- value ranging from 1 to 8
        line number -- value ranging from 1 to 8

spirit.1.19.AUSM8.a >
```

dspalm

Use the **dspalm** command to view the alarms associated with a specified line.

Full Name

Display Alarms for a Line

Card(s) on Which This Command Executes

PXM, FRSM, AUSM, CESH, VISM

Old Syntax

dspalm -ds1 <LineNum> | -ds3 <LineNum> | -e3 <LineNum> | -plcp <PCLPNum> | -sonet <LineNum>

New Syntax

dspalm -ds1 <LineNum> | -ds3 <LineNum> | -e3 <LineNum> | -plcp <PCLPNum> | -sonet <LineNum> |

-hs1 <LineNum>

Syntax Description

-ds1	Command delineator that precedes the <i>LineNum</i> entry for a T1 interface.
<i>LineNum</i>	Line number, in the range 1–8 (FRSM, VISM, AUSM, or CESM).
-ds3	Command delineator that precedes the <i>LineNum</i> entry for a T3 interface.
<i>LineNum</i>	Line number in the form <i>slot.line</i> . <ul style="list-style-type: none"> • Slot = enter a value from the range 7, 8, 15, 16, 31, 32 • Line range = 1–3
-e3	Command delineator that precedes the <i>LineNum</i> entry for an E3 interface.
<i>LineNum</i>	Line number in the form <i>slot.line</i> . <ul style="list-style-type: none"> • Slot = enter a value from the range 7, 8, 15, 16, 31, 32 • Line range = 1–3
-plcp	Command delineator that precedes the <i>PCLPNum</i> entry.
<i>PCLPNum</i>	Line number in the form <i>slot.line</i> . <ul style="list-style-type: none"> • Slot = enter a value from the range 7, 8, 15, 16, 31, 32 • Line range = 1–3
-sonet	Command delineator that precedes the <i>PCLPNum</i> entry for the SONET interface.
<i>LineNum</i>	Line number in the form <i>slot.line</i> . <ul style="list-style-type: none"> • Slot = enter the value either 7 or 8 • OC-3 line range = 1–4 • OC-12 = enter the value 1
-hs1	Command delineator that precedes the <i>LineNum</i> entry for a HS1 interface (for FRSM-HS1).
<i>LineNum</i>	Line number = 1– <i>n</i> , where: <i>n</i> = 4 if FRSM.

Related Commands

clralm, dspalms

Attributes

Log: No State: Active Privilege: Any

Examples

This section contains the following examples:

- PXM—Display alarms on T3 line number 2
- PXM—Display alarms on the OC-3 line number 1
- PXM—Display alarms on the E1 line number 1

- AUSM—Display alarms on the T1 line number 1
- VISM—Display alarms on line number 1
- FRSM—Display alarms on line number 3

Example 1-162 On a PXM, display alarms on the T3 line number 2

```
spirit.1.7.PXM.a > dspalm -ds3 7.2

LineNum:                2
LineAlarmState:         No Alarms
LineStatisticalAlarmState: No Statistical Alarms

spirit.1.7.PXM.a >
```

Example 1-163 On a PXM, display alarms on OC-3 line 1

```
spirit.1.7.PXM.a > dspalm -sonet 7.1

LineNum:                1
SectionCurrentStatus:   Clear
LineCurrentStatus:      Clear
PathCurrentStatus:      Clear
SectionStatAlarmStatus: Clear
LineStatAlarmStatus:    Clear
PathStatAlarmStatus:    Clear

spirit.1.7.PXM.a >
```

Example 1-164 On a PXM, display alarms on E3 line 1

```
wilco.1.7.PXM.a > dspalm -e3 7.1

LineNum:                1
LineAlarmState:         XmtRAI,RcvLOS
LineStatisticalAlarmState: UAS15minAlarm,UAS24hrAlarm

wilco.1.7.PXM.a >
```

Example 1-165 On an AUSM, display alarms on T1 line 1

```
spirit.1.19.AUSM8.a > dspalm -ds1 1

LineNum:                1
LineAlarmState:         Alarm(s) On --
                        RcvLOS
LineStatisticalAlarmState: Alarm(s) On --
                        UAS15minAlarm
                        UAS24hrAlarm

spirit.1.19.AUSM8.a >
```

Example 1-166 Display alarms on VISM line 1

```
spirit.1.5.VISM8.a > dspalm -ds1 1

LineNum:                1
LineAlarmState:         No Alarms
LineStatisticalAlarmState: No Statistical Alarms

spirit.1.5.VISM8.a >
```

Example 1-167 On an FRSM, display alarms on line 3

```
man.1.4.FRSM.a > dspalm -hs1 3

LineNum:                3
LineAlarmState:         Alarm(s) On --
                        Cabletype mismatch - either (DTE/DCE) or (X.21/V.35)is wrong
```

dspalmcnf

Use the **dspalmcnf** command to view the threshold information about the alarm statistics being collected.

Full Name

Display Alarm Configuration

Card(s) on Which This Command Executes

PXM, FRSM, AUSM, CESH, VISM

Syntax

dspalmcnf -ds1 <LineNum> | -ds3 <LineNum> | -e3 <LineNum> | -plcp <PCLPNum> | -sonet <LineNum>

Syntax Description

- ds1** Command delineator that precedes the *LineNum* entry for a T1 interface.
- LineNum* Line number, in the range 1–8 (FRSM, VISM, AUSM, or CESM).
- ds3** Command delineator that precedes the *LineNum* entry for a T3 interface.
- LineNum* Line number in the form *slot.line*.
 - Slot = enter a value from the range 7, 8, 15, 16, 31, 32
 - Line range = 1–3
- e3** Command delineator that precedes the *LineNum* entry for an E3 interface.
- LineNum* Line number in the form *slot.line*.
 - Slot = enter a value from the range 7, 8, 15, 16, 31, 32
 - Line range = 1–3
- plcp** Command delineator that precedes the *PCLPNum* entry.
- PCLPNum* Line number in the form *slot.line*.
 - Slot = enter a value from the range 7, 8, 15, 16, 31, 32
 - Line range = 1–3
- sonet** Command delineator that precedes the *PCLPNum* entry for the SONET interface.
- LineNum* Line number in the form *slot.line*.
 - Slot = enter the value either 7 or 8
 - OC-3 line range = 1–4
 - OC-12 = enter the value 1

Syntax for FRSM-HS1

dspalmcnf -hs1 <*LineNum*>

Syntax Description

- LineNum* Line number = 1 – *n* where:
 $n = 4$ if FRSM

Related Commands

dspalm, dspalms

Attributes

Log: No State: Active Privilege: Any

Examples

This section contains the following examples:

- Display alarm configuration for FRSM line 4
- Display alarm configuration for the current PXM
- Display the alarm configuration on the current AUSM for E1 line 1
- Display the alarm configuration on the current FRSM-2T3 for line 1

Example 1-168 Display the alarm configuration for FRSM line 4 (slot 17 in this example)

```
spirit.1.17.FRSM.a > dspalmcnf -ds1 17.4
```

Line	Severity		AlarmUpCount		AlarmDnCount		AlarmThreshold	
	Red	/ RAIS	NE	/ FE	NE	/ FE	NE	/ FE
17.4	Major	/Minor	6	/1	1500	/6	1	/1500

```
spirit.1.17.FRSM.a >
```

Example 1-169 Display the alarm configuration for the current PXM

```
spirit.1.7.PXM.a > dspalmcnf -ds3 7.1
```

LineNum:	1		
RedSeverity:	Major		
RAISeverity:	Minor		
NEAlarmUpCount:	6		
NEAlarmDnCount:	1		
NEAlarmThreshold:	150		
FEAlarmUpCount:	6		
FEAlarmDnCount:	1		
FEAlarmThreshold:	150		
StatisticalAlarmSeverity:	Minor		
LCV15minThreshold:	3870		
LCV24hrThreshold:	38650		
LES15minThreshold:	86		
LES24hrThreshold:	864	PSES24hrThreshold:	40
LSES15minThreshold:	4	SEFS15minThreshold:	120
LSES24hrThreshold:	40	SEFS24hrThreshold:	1200
PCV15minThreshold:	382	AISS15minThreshold:	120
PCV24hrThreshold:	3820	AISS24hrThreshold:	1200
PES15minThreshold:	86	UAS15minThreshold:	120
PES24hrThreshold:	864	UAS24hrThreshold:	1200
PSES15minThreshold:	4		

Example 1-170 Display the alarm configuration on the current AUSM for E1 line 1

```
spirit.1.19.AUSM8.a > dspalmcnf -ds1 1

LineNum:                1
RedSeverity:             Major
RAISeverity:            Minor
NEAlarmUpCount:         6
NEAlarmDnCount:         6
NEAlarmThreshold:       1
FEAlarmUpCount:         1
FEAlarmDnCount:         1500
FEAlarmThreshold:       1500
StatisticalAlarmSeverity: Minor
lCV15minThreshold:      14
lCV24hrThreshold:       134
lES15minThreshold:      12
lES24hrThreshold:       121
lSES15minThreshold:     10
lSES24hrThreshold:     100
cRC15minThreshold:      14
cRC24hrThreshold:       134
cRCES15minThreshold:    12
cRCES24hrThreshold:     121
cRCSES15minThreshold:   10
cRCSES24hrThreshold:   100
SEFS15minThreshold:     2
SEFS24hrThreshold:     17
AISS15minThreshold:     2
AISS24hrThreshold:     17
UAS15minThreshold:     10
UAS24hrThreshold:      10

spirit.1.19.AUSM8.a >
```

Example 1-171 Display the alarm configuration on the current VISM for E1 line 1

```
spirit.1.5.VISM8.a > dspalmcnf -ds1 1

          Severity  AlarmUpCount  AlarmDnCount  AlarmThreshold
Line Red / RAIS    NE / FE      NE / FE      NE / FE
-----
5.1 Major/Minor    6/6          1/1          1500/1500

spirit.1.5.VISM8.a >
```

Example 1-172 Display the alarm configuration on the current FRSM-2T3 for line 1

```
spirit.1.1.VHS2T3.a > dspalmcnf -ds3 1
```

```
LineNum:                1
RedSeverity:            Major
RAISeverity:           Minor
NEAlarmUpCount:        4
NEAlarmDnCount:        3
NEAlarmThreshold:      1200
FEAlarmUpCount:        4
FEAlarmDnCount:        3
FEAlarmThreshold:      1200
StatisticalAlarmSeverity: Minor
LCV15minThreshold:     3870
LCV24hrThreshold:     38650
LES15minThreshold:     86
LES24hrThreshold:     864
LSES15minThreshold:    4
LSES24hrThreshold:    40
PCV15minThreshold:     382
PCV24hrThreshold:     3820
PES15minThreshold:     86
PES24hrThreshold:     864
PSES15minThreshold:    4
PSES24hrThreshold:    40
CCV15minThreshold:     382
CCV24hrThreshold:     3820
CES15minThreshold:     86
CES24hrThreshold:     864
CSES15minThreshold:    4
CSES24hrThreshold:    40
SEFS15minThreshold:    120
SEFS24hrThreshold:    1200
AISS15minThreshold:    120
AISS24hrThreshold:    1200
UAS15minThreshold:     120
UAS24hrThreshold:     1200
```

```
spirit.1.1.VHS2T3.a >
```

dspalmcnt

Use the **dspalmcnt** command to view the alarm counters and statistics.

Full Name

Display Alarm Counters

Card(s) on Which This Command Executes

PXM, FRSM, AUSM, CESH, VISM

Syntax

dspalmcnt -ds1 <LineNum> | -ds3 <LineNum> | -e3 <LineNum> | -plcp <PCLPNum> | -sonet <LineNum>

Syntax Description

-ds1	Command delineator that precedes the <i>LineNum</i> entry for a T1 interface.
<i>LineNum</i>	Line number, in the range 1–8 (FRSM, VISM, AUSM, or CESH).
-ds3	Command delineator that precedes the <i>LineNum</i> entry for a T3 interface.
<i>LineNum</i>	Line number in the form <i>slot.line</i> . <ul style="list-style-type: none">• Slot = enter a value from the range 7, 8, 15, 16, 31, 32• Line range = 1–3
-e3	Command delineator that precedes the <i>LineNum</i> entry for an E3 interface.
<i>LineNum</i>	Line number in the form <i>slot.line</i> . <ul style="list-style-type: none">• Slot = enter a value from the range 7, 8, 15, 16, 31, 32• Line range = 1–3
-plcp	Command delineator that precedes the <i>PCLPNum</i> entry.
<i>PCLPNum</i>	Line number in the form <i>slot.line</i> . <ul style="list-style-type: none">• Slot = enter a value from the range 7, 8, 15, 16, 31, 32• Line range = 1–3
-sonet	Command delineator that precedes the <i>PCLPNum</i> entry for the SONET interface.
<i>LineNum</i>	Line number in the form <i>slot.line</i> . <ul style="list-style-type: none">• Slot = enter the value either 7 or 8• OC-3 line range = 1–4• OC-12 = enter the value 1

Related Commands

clralmcnt, clralmcnts

Attributes

Log: No State: Active Privilege: Any

Examples

This section contains the following examples:

- Display alarm count for the T3 line 1 on the PXM
- Display alarms and counters for line 1 on the current FRSM
- Display alarms and counters for line 1 on the PXM with OC-3
- Display alarms and counters for line 1 (E3) on the PXM
- Display alarms and counters for line 1 on the VISM
- Display alarms and counters for line 1 on the FRSM-2T3

Example 1-173 Display alarm count for line 1 (T3) of a PXM

```
wilco.1.7.PXM.a > dspalmcnt -ds3 7.1
```

```

LineNum:          1
LCVCurrent:       0
LCVLast15minBucket: 0
LCVLast24hrBucket: 0
LESCurrent:       0
LESLast15minBucket: 0
LESLast24hrBucket: 0
LSESCurrent:      0
LSESLast15minBucket: 0
LSESLast24hrBucket: 0
PCVCurrent:       0
PCVLast15minBucket: 0
PCVLast24hrBucket: 0
PESCurrent:       0
PESLast15minBucket: 0
PESLast24hrBucket: 0
PSESCurrent:      0
PSESLast15minBucket: 0
PSESLast24hrBucket: 0
SEFSCurrent:      0
SEFSLast15minBucket: 0
SEFSLast24hrBucket: 0
AISSCurrent:      0
AISSLast15minBucket: 0
AISSLast24hrBucket: 0
UASCurrent:       0
UASLast15minBucket: 0
UASLast24hrBucket: 0
PercentEFS:       0
RcvLOSCount:     1
RcvOOFCount:     0
RcvRAICount:     0
RcvCCVCount:     0
RcvFECCount:     0

```

```
spirit.1.7.PXM.a >
```

Example 1-174 Display alarms and counters for line 1 on the current FRSM

```
spirit.1.11.FRSM.a > dspalmcnt -ds1 1

Line  RcvLOSCount  RcvOOFCount  RcvRAICount  RcvFECCount
-----
11.1          1           2           17           2

spirit.1.11.FRSM.a >
```

Example 1-175 Display alarms and counters for line 1 on the PXM with OC-3

```
spirit11.1.7.PXM.a > dspalmcnt -sonet 7.1

SonetLineNum: 1

SectionCurrentValidFlag: valid
SectionCurrent15minTimeElapsed: 429s
SectionCurrentESS: 0
SectionCurrentSESS: 0
SectionCurrentSEFSs: 0
SectionCurrentCVs: 0
SectionCurrentDayValidFlag: valid
SectionCurrentDayESS: 100
SectionCurrentDaySESS: 100
SectionCurrentDaySEFSs: 100
SectionCurrentDayCVs: 5149776
SectionCounterLOSs: 2
SectionCounterLOFs: 2
LineCurrentValidFlag: valid
LineCurrent15minTimeElapsed: 429s
LineCurrentESS: 0
LineCurrentSESS: 0
LineCurrentCVs: 0
LineCurrentUASs: 0
FarEndLineCurrentValidFlag: valid
FarEndLineCurrent15minTimeElapsed: 429s
FarEndLineCurrentESS: 0
FarEndLineCurrentSESS: 0
FarEndLineCurrentCVs: 0
FarEndLineCurrentFCs: 0
FarEndLineCurrentUASs: 0
FarEndLineCurrentDayValidFlag: valid
FarEndLineCurrentDayESS: 2
FarEndLineCurrentDaySESS: 2
FarEndLineCurrentDayCVs: 46
FarEndLineCurrentDayFCs: 0
FarEndLineCurrentDaySEFSs: 0
LineCurrentDayValidFlag: valid
LineCurrentDayESS: 100
LineCurrentDaySESS: 100
LineCurrentDayCVs: 100
LineCurrentDaySEFSs: 0
LineCounterAIsS: 2
LineCounterRFIs: 0
PathCurrentValidFlag: valid
PathCurrent15minTimeElapsed: 429s
PathCurrentESS: 0

spirit11.1.7.PXM.a >
```

Example 1-176 Display alarms and counters for line 1 (E3) on the PXM

```
spirit11.1.7.PXM.a > dspalmcnt -e3 7.1
```

```

LineNum:          1
LCVCurrent:       0
LCVLast15minBucket: 0
LCVLast24hrBucket: 0
LESCurrent:       0
LESLast15minBucket: 0
LESLast24hrBucket: 0
LSESCurrent:      0
LSESLast15minBucket: 0
LSESLast24hrBucket: 0
SEFSCurrent:      0
SEFSLast15minBucket: 0
SEFSLast24hrBucket: 0
AISSCurrent:      0
AISSLast15minBucket: 0
AISSLast24hrBucket: 0
UASCurrent:       572
UASLast15minBucket: 900
UASLast24hrBucket: 4496
BIP8CVCurrent:    0
BIP8CV15MinBucket: 0
BIP8CV24HrBucket: 0
BIP8ESCurrent:    0
BIP8ES15MinBucket: 0
BIP8ES24HrBucket: 0
BIP8SESCurrent:   0
BIP8SES15MinBucket: 0
BIP8SES24HrBucket: 0
PercentEFS:       100
RcvLOSCount:      0
RcvOOFCount:      0
RcvRAICount:      0
RcvCCVCount:      0
RcvFECCount:      0

```

Example 1-177 Display alarms and counters for line 1 on the VISM

```
spirit.1.5.VISM8.a > dspalmcnt -ds1 1
```

Line	RcvLOSCount	RcvOOFCount	RcvRAICount	RcvFECCount
5.1	0	0	0	4095

```
spirit.1.5.VISM8.a >
```

Example 1-178 Display alarms and counters for line 1 on the FRSM-2T3

```
spirit.1.1.VHS2T3.a > dspalmcnt -ds3 1
```

```
LineNum:          1
LCVCurrent:       0
LCVLast15minBucket: 0
LCVLast24hrBucket: 0
LESCurrent:       0
LESLast15minBucket: 0
LESLast24hrBucket: 0
LSESCurrent:      0
LSESLast15minBucket: 0
LSESLast24hrBucket: 0
PCVCurrent:       0
PCVLast15minBucket: 0
PCVLast24hrBucket: 0
PESCurrent:       0
PESLast15minBucket: 0
PESLast24hrBucket: 0
PSESCurrent:      0
PSESLast15minBucket: 0
PSESLast24hrBucket: 0
CCVCurrent:       0
CCVLast15minBucket: 0
CCVLast24hrBucket: 0
CESCurrent:       0
CESLast15minBucket: 0
CESLast24hrBucket: 0
CSESCurrent:      0
CSESLast15minBucket: 0
CSESLast24hrBucket: 0
SEFSCurrent:      0
SEFSLast15minBucket: 0
SEFSLast24hrBucket: 0
AISSCurrent:      0
AISSLast15minBucket: 0
AISSLast24hrBucket: 0
UASCurrent:       0
UASLast15minBucket: 0
UASLast24hrBucket: 0
PercentEFS:       0
RcvLOSCount:     0
RcvOOFCount:     0
RcvRAICount:     0
RcvCCVCount:     0
RcvFECCount:     0
```

```
spirit.1.1.VHS2T3.a >
```

dspalms

Use the **dspalms** command to view all alarms for the selected line type on the card.

Full Name

Display All Alarms on a Card

Card(s) on Which This Command Executes

PXM, FRSM, AUSM, SRM-3T3, CESM, VISM

Syntax for PXM, FRSM, AUSM, SRM-3T3, CESM, VISM

dspalms <*lineType*> <*slot number*>

Syntax Description

<i>lineType</i>	Line type. <ul style="list-style-type: none"> • -ds1 = T1 or E1 lines • ds3 • e3 • sonet • plcp
<i>slot number</i>	Slot number = enter a value from the range 7, 8, 15, 16, 31, 32. Enter the value either 7 or 8 for SONET.

Syntax for FRSM-HS1

dspalms -<*lineType*>

Syntax Description

<i>lineType</i>	Line type is hs1.
-----------------	-------------------

Related Commands

dspalm

Attributes

Log: No State: Active Privilege: Any

Examples

This section contains the following examples.

- Display alarms on the current FRSM (slot 17, in this case)
- Display alarms on the 2 E3 lines on the current card (a PXM)
- Display alarms on the 3 E1 lines on the current card (a VISM)
- Display alarms on the 2 T3 lines on the current card (an FRSM-2T3)

Example 1-179 Display alarms on the current FRSM (slot 17, in this case)

```
spirit.1.17.FRSM.a > dspalms -ds1
  Line AlarmState StatisticalAlarmState
  ---- -
  17.1 Alarm(s) On No Statistical Alarms
  17.2 No Alarms No Statistical Alarms
  17.3 No Alarms No Statistical Alarms
  17.4 No Alarms No Statistical Alarms
  17.5 Alarm(s) On No Statistical Alarms
  17.6 No Alarms No Statistical Alarms
  17.7 No Alarms No Statistical Alarms
  17.8 No Alarms No Statistical Alarms

spirit.1.17.FRSM.a >
```

Example 1-180 Display alarms on the 2 E3 lines on the current card (a PXM)

```
wilco.1.7.PXM.a > dspalms e3 7

Line : 1
  AlarmState           : XmtRAI,RcvLOS
  StatisticalAlarmState : UAS15minAlarm,UAS24hrAlarm
Line : 2
  AlarmState           : No Alarms
  StatisticalAlarmState : No Statistical Alarms
wilco.1.7.PXM.a >
```

Example 1-181 Display alarms on the 3 E1 lines on the current card (a VISM)

```
spirit.1.5.VISM8.a > dspalms -ds1

Line AlarmState StatisticalAlarmState
---- -
  5.1 No Alarms No Statistical Alarms
  5.2 No Alarms No Statistical Alarms
  5.3 No Alarms No Statistical Alarms

spirit.1.5.VISM8.a >
```

Example 1-182 Display alarms on the 2 T3 lines on the current card (an FRSM-2T3)

```
spirit.1.1.VHS2T3.a > dspalms -ds3

  Line AlarmState StatisticalAlarmState
  ---- -
  1.1 No Alarms No Statistical Alarms
  1.2 No Alarms No Statistical Alarms
```

dspapscfg

Use the **dspapscfg** command to display more Automatic Protection Switching (APS) parameters. APS is a standard that provides a means for SONET line redundancy. APS involves switching between working (active) and protection (standby) SONET lines in the event of a hardware failure detected by the receiving end or by the far-end. *This support only applies to PXM OC3 and PXM OC12 cards.*

The 1.1.20 software release provides support for the SONET Linear APS 1+1 mode.

Full Name

Display APS Configuration

Card(s) on Which This Command Executes

PXM

Syntax

dspapscfg

Related Commands

addapsln, cnfapsln, , delapsln

Attributes

Log: No State: Any Privilege: Any

Example 1-183 Display the APS configuration on the current PXM

```
DENAME.1.7.PXM.a > dspapscfg
  SlotLine Type  SFBER  SDBER  WTR  Direc  Revert
-----
  7.1&8.1  1+1_2  3      5      1  UNI    NRV

DENAME.1.7.PXM.a >
```

Data Components

SlotLine OC-3 or OC-12 line number, in the range appropriate for the associated interface.

- OC-3 range = 1-4.
- OC-12 = enter the value 1.

Type The APS mode. Mode 1+1 is currently supported in the 1.1.20 software release.

SFBER Signal failure BER threshold, in the range 3-5.

- 5 = signal failure BER threshold = 10^{-5} .

SDBER Signal degrade BER threshold, in the range 5-9.

- 5 = signal degrade BER threshold = 10^{-5} .

<i>WTR</i>	Number of minutes to wait before attempting to switch back to the working line, in the range 1 to 12. This setting is not applicable if the line is configured in non-revertive mode (<i>Revertive</i> set to 1).
<i>Dirac</i>	Value to set the switching direction for either unidirectional or bidirectional. <ul style="list-style-type: none">• UNI = Unidirectional—This APS line supports only one direction.• BI = Bidirectional—This APS line supports both ends of the line.
<i>Revert</i>	Value to set the APS revertive or non-revertive function. <ul style="list-style-type: none">• NRV = Non-revertive• REV = Revertive This setting allows the line to switch back to the working line after the Wait-To-restore interval has expired and the working line SF/SD has been cleared.

dspapsln

Use the **dspapsln** command to display the Automatic Protection Switching (APS) line status.

APS is a SONET switching mechanism that routes traffic from working lines to protect them in case of a line card failure or fiber cut.

Full Name

Display APS Line

Card(s) on Which This Command Executes

PXM

Syntax

dspapsln

Related Commands

addapsln, cnfapsln, dspapscfg, delapsln

Attributes

Log: No State: Active Privilege: Any

Example 1-184 Display the APS line on the current PXM

```
NODENAME.1.7.PXM.a > dspapsln
  SlotLine Type  Act W_LINE P_LINE APS_ST CDTType DirC Revt LastUsrSwReq
-----
  7.1&8.1  1+1_2 7.1 OK      OK      OK      OC-12  UNI  NRV  NO_REQUEST
NODENAME.1.7.PXM.a >
```

Data Components

SlotLine OC-3 or OC-12 line number, in the range appropriate for the associated interface.

- OC-3 range = 1-4
- OC-12 = enter the value 1

Type APS mode. Release 1.1.20 supports the APS 1+1 mode.

Act Line which is currently active.

<i>W-Line</i>	Status of the working line. Value can be one of the following: <ul style="list-style-type: none">• OK = OK• R_SD = remote end signal degrade• SigD = signal degrade• R_AM = remote end signal failure• ALM = line alarm• SigF = signal failure• MIS = backcard mismatch or missing• LOOPBK = line loopback
<i>P-Line</i>	Status of the protection line. Value can be one of the following: <ul style="list-style-type: none">• OK = OK• R_SD = remote end signal degrade• SigD = signal degrade• R_AM = remote end signal failure• ALM = line alarm• SigF = signal failure• MIS = backcard mismatch or missing• LOOPBK = line loopback• P_D = protocol defection (received K1K2 bytes are not expected)• P_B = protection byte failure
<i>APS-ST</i>	APS status. Value can be one of the following: <ul style="list-style-type: none">• OK = OK• AR_MIS = Architecture mismatch• DI_MIS = direction mismatch• CH_MIS = channel mismatch• PL_ALM = line alarm on protection line
<i>CDType</i>	Back card type, either OC-3 or OC-12.
<i>Dir</i>	Value to set the switching direction for either unidirectional or bidirectional. <ul style="list-style-type: none">• Uni = Unidirectional. This APS line supports only one direction.• Bi = Bidirectional. This APS line supports both ends of the line.
<i>Revertive</i>	Value to set the APS revertive or non-revertive function. <ul style="list-style-type: none">• NRV = Non-revertive• RV = Revertive. This setting allows the line to switch back to the working line after the Wait-To-Restore interval has expired and the working line SF/SD has been cleared.
<i>LastUsrSwReq</i>	Last user switching request.

dspatmlncnf

Use the **dspatmlncnf** command to view the cell header configuration for the line. The display indicates NNI or UNI cell headers. The configuration is the result of **cnfatmln** execution. This command applies to stand-alone configurations of the MGX 8800 series switch.

Full Name

Display ATM Line Configuration

Card(s) on Which This Command Executes

PXM

Syntax

dspatmlncnf <line_num>

Syntax Description

line_num Line number in the range 1–*n*, as appropriate for the card.

Related Commands

cnfatmln, **clratmlncnt**

Attributes

Log: No State: Any Privilege: Any

Example 1-185 Display the line configuration for line 2 of PXM

```
wilco.1.7.PXM.a > dspatmlncnf 2

  lineNum  atmLineInterfaceFormat
-----
      2           NNI

wilco.1.7.PXM.a >
```

dspatmlncnt

Use the **dspatmlncnt** command to view the ATM cell counters for the specified line. The display shows the total number of cells received, the total number of cells transmitted, and the number of cells received with HEC errors. The configuration is the result of **cnfatmlncnt** execution. This command applies to stand-alone configurations of the MGX 8800 series switch.

Full Name

Display ATM Line Counters

Card(s) on Which This Command Executes

PXM

Syntax

dspatmlncnt <line_num>

Syntax Description

line_num Line number in the range 1–n, as appropriate for the card.

Related Commands

cnfatmln, clratmlncnt, clratmlncnts

Attributes

Log: No State: Any Privilege: Any

Example 1-186 Display the ATM line counters (total cells received, total cells transmitted, and number of cells received with HEC errors) for line 1 of the PXM

```
wilco.1.7.PXM.a > dspatmlncnt 1

Line Number      :          1
Total Rcvd. Cells :    5214310
Total Xmtd. Cells :    368687
Rcvd. HEC Error Cells :          0

wilco.1.7.PXM.a >
```

dspbctype

Use the **dspbctype** command to display the current interface of the 12IN1 dual-personality back card. The back card can be configured with either a V.35 or an X.21 interface.

Full Name

Display Back Card Type

Card(s) on Which This Command Executes

FRSM-HS1B

Syntax

dspbctype

Related Commands

cnfbctype

Attributes

Log: No

State: Any

Privilege: Any

Example 1-187 Displaying the back card type on the current FRSM

```
man.1.14.FRSM.a > dspbctype
```

```
Backcard Personality: X.21
```

dspbert

Use the **dspbert** command to view the current BERT configuration.

Full Name

Display BERT

Card(s) on Which This Command Executes

PXM

Syntax

dspbert <slot>

Syntax Description

slot Number of the slot associated with the BERT session for this display.

Related Commands

cnfbert, **modbert**

Attributes

Log: No State: Active Privilege: Any

dspcbclk

Use the **dspcbclk** command to display the current clock rate setting. Using this command, you can see which service modules are set for a high cell bus (CB) operating clock rate (42 MHz) or a low rate (21 MHz). Note that not all service modules can support a high CB clock rate.

Full Name

Display Cell Bus Clock

Card(s) on Which This Command Executes

FRSM_2CT3, FRSM_2T3, FRSM_2E3, FRSM_HS2, CESM_T3, CESM_E3, VISM_8T1, VISM_8E1, RPM (new), PXM

Syntax

dspcbclk

Related Commands

cnfcbclk

Attributes

Log: No State: Any Privilege: Any

Example 1-188 Display the current CB settings for the PXM1-OC3 module in slot 7

```
popeye12.1.7.PXM.a > dspcbclk
Command Executed :dspcbclk
```

CellBus	Rate (MHz)	Slot
CB1	21	1, 2
CB2	42	3, 4
CB3	21	5, 6
CB4	21	17 - 22
CB5	21	9, 10
CB6	21	11, 12
CB7	21	13, 14
CB8	21	25 - 30

dspcd

Use the **dspcd** command to view characteristics of the current card's hardware and firmware, and information on its status. Card characteristics include serial number and hardware and firmware revision levels. Status may include the reason for the last reset (FunctionModuleResetReason) and state of the integrated alarm (cardIntegratedAlarm), which can be useful in debugging the card or an MGX 8800 series switch, respectively. Some of the information is common to the **version** command display, but **version** shows boot code version in bold.

Full Name

Display Card

Card(s) on Which This Command Executes

PXM, FRSM, AUSM, CESM, VISM

Syntax

dspcd [*slot number*]

Syntax Description

slot number PXM = Enter the slot number of the service module you want to view, using the value 15, or 16, or a value in the range 31–32.

Slot number is not necessary when logged into a service module.

Related Commands

dspcds, **version**

Attributes

Log: No

State: Any

Privilege: Any

Examples

This section contains the following examples.

- **dspcd** on the current AUSM-8T1
- **dspcd** on the current PXM
- **dspcd** on the current FRSM-8T1
- **dspcd** on the current FRSM-2CT3
- **dspcd** on the current FRSM-8E1
- **dspcd** on the current CESM-8T1
- **dspcd** on the current VISM-8E1
- **dspcd** on the current PXM (viewing the SRM-T3E3 in slot 15)

Example 1-189 dspcd on the current PXM

```

popeye3.1.8.PXM.a > dspcd

ModuleSlotNumber:      8
FunctionModuleState:   Active
FunctionModuleType:    PXM1-OC3
FunctionModuleSerialNum: SBK02420044
FunctionModuleHWRev:   09
FunctionModuleFWRev:   1.1.01Hi
FunctionModuleResetReason: Reset From Shell
LineModuleType:       PXM-UI
LineModuleState:      Present
SecondaryLineModuleType: MMF-4-155
SecondaryLineModuleState: Present
mibVersionNumber:     0.0.00
configChangeTypeBitMap: No changes
cardIntegratedAlarm:  Major
cardMajorAlarmBitMap: Line Alarm
cardMinorAlarmBitMap: Line Statistical Alarm

popeye3.1.8.PXM.a >

```

Example 1-190 dspcd on the current FRSM-8T1

```

node1.1.4.FRSM.a > dspcd

ModuleSlotNumber:      3
FunctionModuleState:   Active
FunctionModuleType:    FRSM-8T1
FunctionModuleSerialNum: 622758
FunctionModuleHWRev:   bb
FunctionModuleFWRev:   5.0.00ak
FunctionModuleResetReason: Power reset
LineModuleType:       LM-RJ48-8T1
LineModuleState:      Present
mibVersionNumber:     20
configChangeTypeBitMap: CardCnfChng, LineCnfChng
cardIntegratedAlarm:  Clear
fab number:           282069-01

node1.1.4.FRSM.a >

```

Example 1-191 dspcd on the current FRSM-2CT3

```

spirit.1.17.FRSM.a > dspcd

ModuleSlotNumber:      3
FunctionModuleState:   Active
FunctionModuleType:    FRSM-2CT3
FunctionModuleSerialNum: CAB024804K8
FunctionModuleHWRev:   ex
FunctionModuleFWRev:   5.0.00_11Jan99_1_tti
FunctionModuleResetReason: Reset by ASC from Cell Bus
LineModuleType:       LM-BNC-2T3
LineModuleState:      Present
mibVersionNumber:     20
configChangeTypeBitMap: CardCnfChng, LineCnfChng
cardIntegratedAlarm:  Clear
pcb part no-(800 level): 800-02910-04
pcb part no-(73 level): 73-02265-04

spirit.1.17.FRSM.a >

```

Example 1-192 dspcd on the current FRSM-8E1

```

ModuleSlotNumber:      3
FunctionModuleState:   Active
FunctionModuleType:    FRSM-8E1
FunctionModuleSerialNum: 782908
FunctionModuleHWRev:   ab
FunctionModuleFWRev:   5.0.00_21Dec98
FunctionModuleResetReason: Power reset
LineModuleType:       LM-RJ48-8E1
LineModuleState:      Present
mibVersionNumber:     20
configChangeTypeBitMap: CardCnfChng, LineCnfChng
cardIntegratedAlarm:  Major
cardMajorAlarmBitMap: Line Alarm
cardMinorAlarmBitMap: Channel failure
fab number:           28-2069-02
    
```

Example 1-193 dspcd on the current CESM-8T1

```

ModuleSlotNumber:      1
FunctionModuleState:   Active
FunctionModuleType:    CESM-8T1
FunctionModuleSerialNum: 786327
FunctionModuleHWRev:   ab
FunctionModuleFWRev:   5.0.00bq
FunctionModuleResetReason: Reset by ASC from Cell Bus
LineModuleType:       LM-RJ48-8T1
LineModuleState:      Present
mibVersionNumber:     20
configChangeTypeBitMap: CardCnfChng, LineCnfChng
cardIntegratedAlarm:  Major
cardMajorAlarmBitMap: Line Alarm
cardMinorAlarmBitMap: Channel failure

fab number:           28-2199-02
    
```

Example 1-194 dspcd on the current AUSM-8T1

```

spirit.1.19.AUSM8.a > dspcd

ModuleSlotNumber:      14
FunctionModuleState:   Active
FunctionModuleType:    AUSM-8T1
FunctionModuleSerialNum: FNTYPE
FunctionModuleHWRev:   fk
FunctionModuleFWRev:   model-A 2.0.00
FunctionModuleResetReason: Reset by PXM from PIO
LineModuleType:       LM-DB15-8T1
LineModuleState:      Present
mibVersionNumber:     4
configChangeTypeBitMap: CardCnfChng, LineCnfChng
cardIntegratedAlarm:  Minor
cardMinorAlarmBitMap: Channel failure
spirit.1.19.AUSM8.a >
    
```

Example 1-195 dspcd on the current VISM-8E1

```
spirit.1.5.VISM8.a > dspcd
ModuleSlotNumber:      5
FunctionModuleState:   Active
FunctionModuleType:    VISM-8E1
FunctionModuleSerialNum: CAB0246014W
FunctionModuleHWRev:   0.0
FunctionModuleFWRev:   rangar
FunctionModuleResetReason: Power reset
LineModuleType:        LM-RJ48-8E1
LineModuleState:       Present
mibVersionNumber:      20
configChangeTypeBitMap: CardCnfChng, LineCnfChng
cardIntegratedAlarm:   Clear
pcb part no - (800 level): 800-04399-01
pcb part no - (73 level):  73-03618-01
Fab Part no - (28 level):  28-02791-01
PCB Revision:          05

Daughter Card Information:
Daughter Card Serial Number: CAB024601FU
pcb part no - (73 level):  73-03722-01
Fab Part no - (28 level):  28-02905-01
PCB Revision:             02
spirit.1.5.VISM8.a >
```

Example 1-196 dspcd on the current PXM (viewing the SRM-T3E3 in slot 15)

```
tinky.1.7.PXM.a > dspcd 15

ModuleSlotNumber:      15
FunctionModuleState:   Active
FunctionModuleType:    SRM-3T3
FunctionModuleSerialNum: 785324
FunctionModuleHWRev:   be
FunctionModuleFWRev:   1.0.00
FunctionModuleResetReason: Reset From Shell
LineModuleType:        LM-SRM-3T3
LineModuleState:       Present
SecondaryLineModuleType: Missing
SecondaryLineModuleState: Invalid
mibVersionNumber:      0.0.06
configChangeTypeBitMap: No changes
cardIntegratedAlarm:   Clear
cardMajorAlarmBitMap:  Clear
cardMinorAlarmBitMap:  Clear

tinky.1.7.PXM.a >
```

dspcderrs

Use the **dspcderrs** command to view information about card errors.

Full Name

Display Card Errors

Card(s) on Which This Command Executes

PXM, FRSM, AUSM, VISM, CESH

Syntax

dspcderrs

Attributes

Log: No State: Any Privilege: Any

Example 1-197 Display card errors on the PXM module in slot 7

```
wilco.1.7.PXM.a > dspcderrs

dspcderrs
08/05/95-18:53:05 tRootTask 3 Task failed : scm
09/05/95-09:14:08 tRootTask 3 Task failed : scm
value = 0 = 0x0

wilco.1.7.PXM.a >
```

dspcdprtntype

Use the **dspcdprtntype** command to view partition type on the current card.

Full Name

Display Card Resource Type

Card(s) on Which This Command Executes

PXM, FRSM, AUSM, CESH

Syntax

dspcdprtntype

Related Commands

cnfcdprtntype

Attributes

Log: No State: Any Privilege: Any

Example 1-198 Display the card resource partition type on the current PXM

```
spirit.1.7.PXM.a > dspcdprtntype  
  
cardLenPartitionType : controllerBased  
  
spirit.1.7.PXM.a >
```

dspcdrsoprtn

Use the **dspcdrsoprtn** command to view allocated resource information to a controller.

Note The **dspcdrsoprtn** command applies only to cards with a card partition type of *controllerBased*.

Full Name

Display Card Resource Partition

Card(s) on Which This Command Executes

PXM, FRSM, AUSM, VISM

Syntax

dspcdrsoprtn

Related Commands

addcdrsoprtn

Attributes

Log: No State: Any Privilege: Any

Examples

This section contains the following examples:

- Display the number of LCNs available for each of the three possible partitions on the current card (FRSM 2CT3)
- Display the number of LCNs available for each of the three possible partitions on the current card (FRSM 8T1)
- Display the number of LCNs available for each of the three possible partitions on the current card (PXM T1)

Example 1-199 Display the number of LCNs available for each of the three possible partitions on the current card (FRSM 2CT3)

```
spirit.1.13.VHS2CT3.a > dspcdrsoprtn
```

```

User      Status  NumOfLcnAvail
-----
PAR       Add     1000
PNNI     Add     1000
TAG       Add     1000

```

```
spirit.1.13.VHS2CT3.a >
```

Example 1-200 Display the number of LCNs available for each of the three possible partitions on the current card (CESM 8T1)

```
spirit.1.17.CESM.a > dspcdrsoprtn
```

```
User      Status  NumOfLcnAvail
-----  -
PAR       Mod     248
PNNI     Mod     248
TAG       Mod     248
spirit.1.17.CESM.a >
```

Example 1-201 Display the number of LCNs available for each of the three possible partitions on the current card (FRSM 8T1)

```
spirit.1.1.FRSM.a > dspcdrsoprtn
```

```
User      Status  NumOfLcnAvail
-----  -
PAR       Add     1000
PNNI     Add     1000
TAG       Add     1000
spirit.1.1.FRSM.a >
```

Example 1-202 Display the number of LCNs available for each of the three possible partitions on the current card (PXM T1)

```
spirit.1.7.PXM.a > dspcdrsoprtn
```

```
Controller  Status      Number of Available LCNs
-----  -
PAR         Enabled     32767
PNNI       Enabled     32767
TAG        Enabled     32767
spirit.1.7.PXM.a >
```

dspcds

Use the **dspcds** command to view the status of all the cards in the MGX 8800 series switch shelf.

Full Name

Display Card Shelf Information

Card(s) on Which This Command Executes

PXM

Syntax

dspcds

Related Commands

dspcd

Attributes

Log: No

State: Active

Privilege: Any

Example 1-203 Display all cards currently installed in the switch

wilco.1.7.PXM.a > dspcds

Slot	CardState	CardType	CardAlarm	Redundancy
1.1	Active	FRSM-8T1	Major	
1.2	Empty		Clear	
1.3	Active	FRSM-2CT3	Clear	
1.4	Empty		Clear	
1.5	Empty		Clear	
1.6	Empty		Clear	
1.7	Active	PXM1-T3E3	Major	
1.8	Empty		Clear	
1.9	Empty		Clear	
1.10	Empty		Clear	
1.11	Empty		Clear	
1.12	Active	RPM	Clear	
1.13	Empty		Clear	
1.14	Empty		Clear	
1.15	Empty		Clear	
1.16	Empty		Clear	
1.17	Active	CESM-8E1	Clear	
1.18	Empty		Clear	
1.19	Empty		Clear	
1.20	Empty		Clear	
1.21	Empty		Clear	
1.22	Empty		Clear	
1.25	Empty		Clear	
1.26	Empty		Clear	
1.27	Empty		Clear	
1.28	Empty		Clear	
1.29	Empty		Clear	
1.30	Empty		Clear	
1.31	Empty		Clear	
1.32	Empty		Clear	

ClearNumOfValidEntries: 32

NodeName: wilco
Date: 02/01/1999
Time: 07:32:41
TimeZone: PST
TimeZoneGMTOff: -8
StatsMasterIpAddress: 0.0.0.0

shelfIntegratedAlarm: Major
BkplnSerialNum: 12345
BkplnType: 2
BkplnFabNumber: 73-0123-01
BkplnHwRev: 80

wilco.1.7.PXM.a >

dspchan

Use the **dspchan** command to view a channel on a PXM, FRSM, VISM, AUSM, or CESM.

Full Name

Display Channel

Card(s) on Which This Command Executes

PXM, FRSM, AUSM, CESM, VISM

Syntax

dspchan <chan_num>

Syntax Description

chan_num Channel number, as appropriate for the card.

- PXM, range = 16–4111
- FRSM range = 16–1015
- AUSM range = 16–1015
- CESM range = 32–279

Related Commands

dspchans, **cnfchan**

Attributes

Log: No State: Any Privilege: Any

Examples

This section contains the following examples:

- Display the channel characteristics of channel 69 on an FRSM
- Display the channel characteristics of channel 16 on an AUSM
- Display the channel characteristics of channel 32 on the current CESM
- Display the channel characteristics of channel 16 on the current PXM

Example 1-204 Display the channel characteristics of channel 69 on an FRSM

```
spirit.1.17.FRSM.a > dspchan 69

ChanNum:                69
ChanRowStatus:          Mod
ChanPortNum:            1
ChanDLCI:               100
EgressQSelect:         1
IngressQDepth:         65535
IngressQDEThresh:      32768
IngressQECNThresh:     65535
EgressQDepth:          65535
EgressQDEThresh:      32768
EgressQECNThresh:     6553
DETaggingEnable:       Disabled
CIR:                   24000
Bc:                   5100
Be:                   5100
IBS:                  100
ForeSightEnable:       Enabled
QIR:                   260
MIR:                   62
PIR:                   500
ChanLocalRemoteLpbkState: Enabled
ChanTestType:          TestOff
ChanTestState:         NotInProgress
ChanRTDresult:         65535 ms
ChanType:              NIW
ChanFECNmap:           setEFCIzero
ChanDEtoCLPmap:       mapCLP
ChanCLPtoDEmap:       mapDE
ChanFrConnType:        PVC
ChanIngrPercentUtil:  100
ChanEgrPercentUtil:   100
ChanEgrSrvRate:        1536000
ChanOvrSubOvrRide:     Enabled
ChanLocalVpi:          0
ChanLocalVci:          100
ChanLocalNSAP:         535052494e543031000000000000000002000100
ChanRemoteVpi:         10
ChanRemoteVci:         134
ChanRemoteNSAP:        535052494e543031000000000000000000000100
ChanMastership:        Master
ChanVpcFlag:           Vcc
ChanConnServiceType:   ATFR
ChanRoutingPriority:    1
ChanMaxCost:           255
ChanRestrictTrunkType: No Restriction
ChanConnPCR:           4000
ChanConnMCR:           4000
ChanConnPercentUti:    100

ChanNumNextAvailable:  17

spirit.1.17.FRSM.a >
```

Example 1-205 Display the channel characteristics of channel 16 on an AUSM

```

spirit.1.19.AUSM8.a > dspchan 16

ChanNum:                16
RowStatus:              Del
ConnectionType:         VCC
ServiceType:            CBR
ChanSvcFlag:            PVC
PortNum:                1
VPI:                   0
VCI (For VCC):         0
Local VPIId(for VPC):  0
EgressQNum:            0
IngressQDepth(cells):  1000
IngressDiscardOption:  CLP hysteresis
IngressFrameDiscardThreshold: 1000
IngressQCLPHigh(cells): 900
IngressQCLPLow(cells): 800
QCLPState:             LOW
IngressEfciThreshold(cells): 1000
UPCEnable:             Enabled
PeakCellRate[0+1](cells/sec): 50
CellDelayVariation[0+1]: 10000 (micro secs)
PeakCellRate[0](cells/sec): 50
CellDelayVariation[0]: 10000 (micro secs)
SustainedCellRate(cells/sec): 50
MaximumBurstSize(cells): 1000
SCRPolicing:           CLP[0]
CLPTagEnable:          Enabled
FrameGCRAEnable:      Disable
ForesightEnable:      Disable
InitialBurstSize(cells): 0
ForeSightPeakCellRate(cells/sec): 50
MinimumCellRate(cells/sec): 0
InitialCellRate(cells/sec): 1
LocalRemoteLpbkState:  Disable
ChanTestType:         No Test
ChanTestState:        Not In Progress
ChanRTDresult:        65535 ms
Ingress percentage util: 100
Egress percentage util : 100
Egress Service Rate:  50
LocalVpi:             0
LocalVci:             0
LocalNSAP:            5468697320697320612064756d6d79204e534150
RemoteVpi:            0
RemoteVci:            0
RemoteNSAP:           5468697320697320612064756d6d79204e534150
Mastership:           Slave
VpcFlag:              Vcc
ConnServiceType:      CBR
RoutingPriority:       1
MaxCost:               255
RestrictTrunkType:    No Restriction
ConnPCR:               50
ConnMCR:               0
ConnPercentUtil:      100

ChanNumNextAvailable   : 17
Local VpId NextAvailable : 2

spirit.1.19.AUSM8.a >

```

Example 1-206 Display the channel characteristics of channel 32 on the current CESM

```
MGX-01.1.1.CESM.a > dspchan 32

ChanNum:                32
ChanRowStatus:          Add
ChanLineNum:            1
ChanMapVpi:             1
ChanMapVci:             32
ChanCBRService:         structured
ChanClockMode:          Synchronous
ChanCAS:                Basic
ChanPartialFill:        47
ChanMaxBufSize:         6144 bytes
ChanCDV:                6000 micro seconds
C L I P:               2500 milliseconds
ChanLocalRemoteLpbkState: Disabled
ChanTestType:           TestOff
ChanTestState:          NotInProgress
ChanRTDresult:          65535 ms
ChanPortNum             1
ChanConnType            PVC
ISDetType               DetectionDisabled
CondData                255
CondSignalling          0
ExtISTrig               DisableIdleSupression
ISIntgnPeriod           4095 seconds
ISSignallingCode        0
OnHookCode              1
ChanLocalVpi:           0
ChanLocalVci:           1
ChanLocalNSAP:          535052494e543031000000000000000001000100
ChanRemoteVpi:          10
ChanRemoteVci:          132
ChanRemoteNSAP:         535052494e543031000000000000000000000100
ChanMastership:         Master
ChanVpcFlag:            Vcc
ChanConnServiceType:    CBR
ChanRoutingPriority:    1
ChanMaxCost:            255
ChanRestrictTrunkType:  No Restriction
ChanConnPCR:            4128
ChanConnMCR:            4128
ChanConnPercentUtil:    100

ChanNumNextAvailable:  32

MGX-01.1.1.CESM.a >
```

Example 1-207 Display the channel characteristics of channel 16 on the current PXM

```
MGX-01.1.7.PXM.a > dspchan 16

bbChanCnfNum           : 16
bbChanRowStatus        : 1
bbChanConnType         : 2
bbChanServiceType      : 1
bbChanConnDesc         : 0x828d4e30
bbChanSvcFlag          : 2
bbChanSvcConnId        : 0
bbChanIfNum            : 1
bbChanVpi              : 10
bbChanVci              : 134
bbChanUpcEnable        : 1
bbChanUpcPCR           : 50
bbChanUpcCDVT          : 10000
bbChanUpcSCR           : 0
bbChanUpcMBS           : 0
bbChanGcra1Action      : 1
bbChanGcra2Action      : 1
bbChanEfciThreshold    : 98304
bbChanDiscardOption    : 1
bbChanFrmDiscardThreshold : 0
bbChanClpHiThreshold   : 0
bbChanClpLoThreshold   : 0
bbChanCongstUpdateCode : 1
bbChanMaxCellMemThreshold : 131072
bbChanIngrPercentUtil  : 100
bbChanEgrPercentUtil   : 100
bbChanEgrSrvRate       : 50
bbChanOvrSubOvrRide    : 2
bbChanLocalVpi         : 10
bbChanLocalVci         : 134
bbChanLocalNsapAddr    : 0x828d4a20
bbChanRemoteVpi        : 0
bbChanRemoteVci        : 100
bbChanRemoteNsapAddr   : 0x828d49f0
bbChanMaster           : 2
bbChanRtePriority       : 1
bbChanMaxCost          : 255
bbChanRestrictTrkType  : 1
bbChanTestType         : 3
bbChanTestState        : 4
bbChanTestResult       : 0
bbChanTestTypeCPESide  : 2
bbChanTestStateCPESide : 4
bbChanUpcSCRPolicing   : 3
bbConnVpcFlag          : 2
bbConnServiceType      : 1
bbConnPCR              : 50
bbConnSCR              : 0
bbConnPercentUtil      : 100
bbRemoteConnPCR        : 50
bbRemoteConnSCR        : 0
bbRemoteConnPercentUtil : 100

MGX-01.1.7.PXM.a >
```

Example 1-208 Display the channel characteristics of channel 37 on the current VISM

```
spirit.1.5.VISM8.a > dspchan 37

ChanNum:                37
ChanRowStatus:          Add
ChanLocalRemoteLpbkState: Disabled
ChanTestType:           TestOff
ChanTestState:          NotInProgress
ChanRTDresult:          65535 ms
ChanPortNum:            1
ChanPvcType:            VoIP
ChanConnectionType:     PVC
ChanLocalVpi:           0
ChanLocalVci:           1
ChanLocalNSAP:          4e4f44454e4114d4500000000000000005000100
ChanRemoteVpi:          58
ChanRemoteVci:          59
ChanRemoteNSAP:         4e4f44454e4114d4500000000000000000000000100
ChanMastership:         Master
ChanVpcFlag:            Vcc
ChanConnServiceType:    CBR
ChanRoutingPriority:     1
ChanMaxCost:            255
ChanRestrictTrunkType:  No Restriction

Type <CR> to continue, Q<CR> to stop:

ChanConnPCR:            100000
ChanConnPercentUtil:    100

ChanNumNextAvailable:   34

Syntax : dspchan "chan_num"
        channel number -- values : 32 - 255

spirit.1.5.VISM8.a >
```

dspchancnt

Use the **dspchancnt** command to view the contents of the statistical counters for a channel.

Full Name

Display Channel Counters

Card(s) on Which This Command Executes

PXM, FRSM, CESM

Syntax

dspchancnt <channel number>

Syntax Description

channel number Channel number, in the range appropriate for the card.

- FRSM
 - 8T1/E1 range = 16–1015
 - HS1/B range = 16–1015
 - T3/E3/HS2 range = 16–2015
 - 2CT3 range = 16–4015
- PXM range = 16–4111
- AUSM range = 16–1015
- CESM
 - 8T1/E1 range = 32–279
 - T3/E3 = one connection starting at 32

Syntax for AUSM

dspchancnt <port.VPI.VCI | ChanNum>

Syntax Description

port.VPI.VCI Port range = 1–n, as appropriate for the physical installation.

VPI range = 1–4095.

VCI range = 1–65535.

ChanNum Channel number, in the range 16–1015.

Related Commands

dspchstats

Attributes

Log: No State: Any Privilege: Any

Examples

This section contains the following examples:

- Display the counters for channel 69 of the current FRSM
- Display the counters for channel 16 of the current AUSM
- Display the counters for channel 32 of the current CESM-8E1

Example 1-209 Display the counters for channel 69 of the current FRSM

```
wilco.1.17.FRSM.a > dspchancnt 69

ChanNum:          69
ChanState:        okay

ChanUpTime:       10186

                                Tx                                Rx
                                -----                                -----
AbitState:         Sending A=1                                Receiving A=1
ATMState:          Not sending any state                       Not receiving any state
Total Frames:      0                                           0
Total Bytes:       0                                           0
Frames DE:         0                                           0
Bytes DE:          0                                           0
Frames Discarded:  0                                           0
Bytes Discarded:   0                                           0
FramesDiscXceedQDepth: 0                                       0
BytesDiscXceedQDepth: 0                                       0
FramesDiscXceedDEThresh: 0                                       0
Frames FECN:       0                                           0
Frames BECN:       0                                           0
FramesTagged FECN: 0                                           0
FramesTagged BECN: 0                                           0
KbpsAIR:           0                                           0
FramesTaggedDE:    0                                           0
BytesTaggedDE:     0                                           0
RcvFramesDiscShelfAlarm: 0                                       0
XmtFramesDiscPhyLayerFail: 0                                       0
XmtFramesDiscCRCError: 0                                       0
XmtFramesDiscReAssmFail: 0                                       0
XmtFramesDiscSrcAbort: 0                                       0
XmtFramesDuringLMIAAlarm: 0                                       0
XmtBytesDuringLMIAAlarm: 0                                       0
RcvFramesDiscUPC: 0                                           0
XmtFramesInvalidCPIs: 0                                       0
XmtFramesLengthViolations: 0                                       0
XmtFramesOversizedSDUs: 0                                       0
XmtFramesUnknownProtocols: 0                                       0
RcvFramesUnknownProtocols: 0                                       0
wilco.1.17.FRSM.a >
```

Example 1-210 Display the counters for channel 16 of the current AUSM

```
wilco.1.19.AUSM.a > dspchancnt 16

ChanNum:                16
ChannelState:           Active
ChannelEgressRcvState:  Normal
ChannelEgressXmitState: Normal
ChannelIngressRcvState: Normal
ChannelIngressXmtState: Normal
ChanInServiceSeconds:   1126725
ChanIngressPeakQDepth(cells): 1
ChanIngressReceiveCells: 41160574
ChanIngressClpSetCells: 0
ChanIngressEfciSetRcvCells: 0
ChanIngressUpcClpSetCells: 0
ChanIngressQfullDiscardCells: 1
ChanIngressClpSetDiscardCells: 0
ChanIngressTransmitCells: 41160574
ChanShelfAlarmDiscardCells: 0

Syntax : dspchancnt "chan_num"
        channel number--value ranging from 16 to 1015
wilco.1.19.AUSM.a >
```

Example 1-211 Display the counters for channel 32 of the current CESM-8E1

```
MGX-01.1.1.1.CESM.a > dspchancnt 32

ChanNum:                32
Chan State:             alarm
Chan RCV ATM State:     Receiving AIS OAM
Chan XMT ATM State:     Sending AIS OAM
Cell Loss Status:       Cell Loss
Reassembled Cells:      0
Generated Cells:        1134344
Header Errors:          0
Seqence Mismatches :    0
Lost Cells:              0
Channel Uptime (secs.)  277
Signalling Status       Offhook

Syntax : dspchancnt "chan_num"
        channel number -- values : 32 - 279
MGX-01.1.1.1.CESM.a >
```

dspchanmap

Use the **dspchanmap** command to view interworking field mapping for a specified channel.

Full Name

Display Channel Map

Card(s) on Which This Command Executes

FRSM

Syntax

dspchanmap -chn <*ChanNum*>

Syntax Description

-chn Command delineator for the *ChanNum* entry.

ChanNum Channel number, in the range 16–1015.

Related Commands

cnfchanmap

Attributes

Log: No

State: Any

Privilege: Any

dspchans

Use the **dspchans** command to view all current channels on the card.

Full Name

Display Channels

Card(s) on Which This Command Executes

FRSM, AUSM, CESM, PXM, VISM

Syntax

dspchans

Related Commands

dspchan, addchan, delchan

Attributes

Log: No

State: Any

Privilege: Any

Examples

This section contains the following examples.

- Display the channels on the current FRSM
- Display the channels on the current PXM
- Display the channels on the current VISM
- Display th channels on the current AUSM8T1/E1

Example 1-212 Display the channels on the current FRSM

```
spirit.11.1.FRSM.a > dspchans
```

DLCI	Chan	EQ	I/EQDepth	I/EQDEThre	I/EECNThre	Fst/DE	Type	Alarm
11.1.1.100	69	1	65535/65535	32768/32768	65535/6553	Ena/Dis	NIW	No
11.1.1.101	70	1	65535/65535	32768/32768	65535/6553	Ena/Dis	NIW	No
11.1.1.102	71	1	65535/65535	32768/32768	65535/6553	Ena/Dis	NIW	No
11.1.1.103	72	1	65535/65535	32768/32768	65535/6553	Ena/Dis	NIW	No
11.1.1.104	73	1	65535/65535	32768/32768	65535/6553	Ena/Dis	NIW	No
11.1.1.105	74	1	65535/65535	32768/32768	65535/6553	Ena/Dis	NIW	No
11.1.1.106	75	1	65535/65535	32768/32768	65535/6553	Ena/Dis	NIW	No
11.1.1.107	76	1	65535/65535	32768/32768	65535/6553	Ena/Dis	NIW	No
11.1.1.108	77	1	65535/65535	32768/32768	65535/6553	Ena/Dis	NIW	No
11.1.1.109	78	1	65535/65535	32768/32768	65535/6553	Ena/Dis	NIW	No
11.1.1.110	79	1	65535/65535	32768/32768	65535/6553	Ena/Dis	NIW	No
11.1.1.111	80	1	65535/65535	32768/32768	65535/6553	Ena/Dis	NIW	No
11.1.1.112	81	1	65535/65535	32768/32768	65535/6553	Ena/Dis	NIW	No
11.1.1.113	82	1	65535/65535	32768/32768	65535/6553	Ena/Dis	NIW	No
11.1.1.114	83	1	65535/65535	32768/32768	65535/6553	Ena/Dis	NIW	No
11.1.1.115	84	1	65535/65535	32768/32768	65535/6553	Ena/Dis	NIW	No
11.1.2.100	85	1	65535/65535	32768/32768	65535/6553	Ena/Dis	NIW	No

```
spirit.11.1.FRSM.a >
```

Example 1-213 Display the channels on the current PXM

```
wilco.1.7.PXM.a > dspchans
```

Chan	Stat	Intf	locVpi	locVci	conTyp	srvTyp	PCR[0+1]	Mst	rmtVpi	rmtVci	State
16	Ena	1	10	134	VCC	CBR	50 Slv	0	100	normal	
32	Ena	1	10	132	VCC	CBR	50 Slv	0	1	alarm	

```
wilco.1.7.PXM.a >
```

Example 1-214 Display the channels on the current VISM

```
spirit.1.5.VISM8.a > dspchans
```

Channel	ChanNum	Status
5.0.1.37	37	Add

```

Number of channels: 1

ChanNumNextAvailable: 33

Syntax : dspchans
spirit.1.5.VISM8.a >
```

Example 1-215 Display the channels on the current AUSM-8T1E1

```
s1.1.12.AUSMB8.a > dspchans
```

Chan	Port.VPI.VCI	ConnType	Service Type	PCR[0+1]	Q-Depth	State
21	2.1.1	VCC	CBR	4528	1000	Active
26	2.1.3	VCC	VBR	4528	1000	Active
31	2.1.5	VCC	ABR	4528	1000	Alarm
37	2.1.7	VCC	UBR	4528	1000	Alarm

dspchstats

Use the **dspchstats** command to view current statistics associated with the specified channel.

Full Name

Display Channel Statistics

Card(s) on Which This Command Executes

FRSM

Syntax

dspchstats <line>.<1stDS0>.<DLCI>

Syntax Description

<i>line</i>	Line number, in the range 1–8.
<i>1stDS0</i>	1st_DS0, in the range appropriate for the interface. <ul style="list-style-type: none">• T1 range = 1–24• E1 range = 1–32
<i>DLCI</i>	Connection for which the statistics are to be displayed.

Related Commands

dspchan, **dspchans**

Attributes

Log: No State: Any Privilege: Any

Example 1-216 Display the counters for line 1, 1st_DS0 of 4, and DLCI of 1000 for the current FRSM

wilco.1.17.FRSM.a > **dspchstats 1.4.1000**

```

lineNum:          1
Physical Port Num: 4
Logical Port Num: 2
ChanDLCI:         1000
ChanNum:          1
ChanState:        okay

ChanUpTime:       10186

                Tx                               Rx
-----
AbitState:        Sending A=1                    Receiving A=1
ATMState:         Not sending any state          Not receiving any state
Total Frames:     0                               0
Total Bytes:      0                               0
Frames DE:        0                               0
Bytes DE:         0                               0
Frames Discarded: 0                               0
Bytes Discarded:  0                               0
FramesDiscXceedQDepth: 0                         0
BytesDiscXceedQDepth: 0                         0
FramesDiscXceedDEThresh: 0                      0
Frames FECN:      0                               0
Frames BECN:      0                               0
FramesTagged FECN: 0                             0
FramesTagged BECN: 0                             0
KbpsAIR:          0                               0
FramesTaggedDE:   0                               0
BytesTaggedDE:    0                               0
RcvFramesDiscShelfAlarm: 0                       0
XmtFramesDiscPhyLayerFail: 0                     0
XmtFramesDiscCRCErr: 0                           0
XmtFramesDiscReAssmFail: 0                       0
XmtFramesDiscSrcAbort: 0                         0
XmtFramesDuringLMIAAlarm: 0                      0
XmtBytesDuringLMIAAlarm: 0                       0
RcvFramesDiscUPC: 0                               0
XmtFramesInvalidCPIs: 0                          0
XmtFramesLengthViolations: 0                     0
XmtFramesOversizedSDUs: 0                        0
XmtFramesUnknownProtocols: 0                     0
RcvFramesUnknownProtocols: 0                      0

```

wilco.1.17.FRSM.a >

dspclkinfo

Use the **dspclkinfo** command to view detailed information about all the configured clock sources in the node.

Full Name

Display Clock Information

Card(s) on Which This Command Executes

PXM

Syntax

dspclkinfo

Related Commands

dspclksrc, cnfclksrc

Attributes

Log: No State: Active Privilege: 3

Example 1-217 Display the detailed clock information for the MGX 8800 series shelf

```
spirit3.1.7.PXM.a > dspclkinfo

***** Clock HW registers *****
SEL_T1 = t1      SEL100 = ON      SEL120 = ON      SEL120 = ON
NOEXTCLK = ON

priMuxClockSource = INTERNAL_OSC
prevPriMuxClockSource = INTERNAL_OSC
primaryInbandClockSourceLineNum = 0
secMuxClockSource = EXTERNAL_CLOCK
prevSecMuxClockSource = EXTERNAL_CLOCK
secondaryInbandClockSourceLineNumber = 1
currentClockSetReq = primary
currentClockHwStat = primary
PreviousClockHwStat = internal
extClockPresent = No
extClkConnectorType = RJ45
extClkSrcImpedance = 100 Ohms
Internal Clock Status=1, Primary Clock Status=1

                Secondary Clock Status=0, Last inband Clock State=0
last Inband Clock state= 0, Last External Clock Present = 1

spirit3.1.7.PXM.a >
```

dspclksrc

Use the **dspclksrc** command to view all configured clock sources in the node.

Full Name

Display Clock Sources

Card(s) on Which This Command Executes

PXM

Syntax

dspclksrc

Related Commands

cnfclksrc

Attributes

Log: No State: Active Privilege: Any

Example 1-218 Display the current clock source for the MGX 8800 series shelf

```
spirit3.1.7.PXM.a > dspclksrc

PrimaryClockSource: Internal Oscillator
SecondaryClockSource: External T1/E1 from C.O.
CurrentClockSource: Internal Oscillator
ClockSwitchState: NoChange
ExtClkPresent: Not Present
ExtClkSrcImpedance: 75 ohms
ExtClkConnectorType: BNC

spirit3.1.7.PXM.a >
```

dspcon

Use the **dspcon** command to view configuration data for a connection.

Full Name

Display Connection

Card(s) on Which This Command Executes

PXM, FRSM, AUSM, CESM, VISM

Syntax

dspcon <port number> <connection number>

Syntax Description

- | | |
|--------------------------|--|
| <i>port number</i> | Port number, in the range 1-8. |
| <i>connection number</i> | Connection number, as appropriate for the card. <ul style="list-style-type: none">• PXM = vpi.vci• FRSM = DLCI• AUSM = vpi.vci• CESM = does not require connection number |

Related Commands

addcon, delcon, dspcons

Attributes

Log: No State: Active Privilege: Any

Examples

This section contains the following examples.

- Display the connection parameters for channel 16 on a CESM.
- Display the connection parameters for the connection on channel 51 (port 3, DLCI 500) on the current FRSM.
- Display the connection parameters for the connection on channel 37 on the current VISM.

Example 1-219 Display the connection parameters for channel 16 on a CESM

```
spirit3.1.22.CESM.a > dspcon 16

ChanNum:                16
RowStatus:              Add
ConnectionType:         VCC
ServiceType:            CBR
PortNum:                1
VPI:                   10
VCI:                   100
EgressQNum:            1
IngressQDepth (cells): 100
IngressQCLPHigh (cells): 70
IngressQCLPLow (cells): 60
IngressEfcThreshold (cells): 50
CompliantCellDelayVariation (micro secs): 0
CompliantInfoRate (cells/sec): 0
InitialBurstSize (cells): 0
MaxFrameSize (cells): 0
PeakInformationRate (cells/sec) 1000
CLPTagEnable:          Disabled
FrameGCRAEnable:      Disabled
spirit3.1.22.CESM.a >
```

Example 1-220 Display the connection parameters for the connection on channel 51 (port 3, DLCI 500) on the current FRSM

```
spirit.1.3.FRSM.a > dspcon 3.500

ChanNum:                51
ChanRowStatus:          Mod
ChanPortNum:            3
ChanDLCI:               500
EgressQSelect:          2
IngressQDepth:          65535
IngressQDEThresh:       32768
IngressQECNThresh:      6554
EgressQDepth:           65535
EgressQDEThresh:        32768
EgressQECNThresh:       6554
DETaggingEnable:        Disabled
CIR:                    1024000
Bc:                     5100
Be:                     5100
IBS:                    100
ForeSightEnable:        Enabled
QIR:                    2666
MIR:                    2666
PIR:                    5333
ChanLocalRemoteLpbkState: Disabled
ChanTestType:           TestOff
ChanTestState:          NotInProgress
ChanRTDresult:          65535 ms
ChanType:               SIW-Xlat
ChanFECNmap:            setEFCIzero
ChanDEtoCLPmap:         mapCLP
ChanCLPtoDEmap:         mapDE
ChanFrConnType:         PVC
ChanIngrPercentUtil:    100
ChanEgrPercentUtil:     100
ChanEgrSrvRate:         1024000
ChanOvrSubOvrRide:      Enabled
ChanLocalVpi:           0
ChanLocalVci:           500
ChanLocalNSAP:          73776973735f703100000000000910003000300
ChanRemoteVpi:          3
ChanRemoteVci:          14
ChanRemoteNSAP:         73776973735f70310000000000091000000100
ChanMastership:         Master
ChanVpcFlag:            Vcc
ChanConnServiceType:    ATFR
ChanRoutingPriority:     1
ChanMaxCost:             255
ChanRestrictTrunkType:  No Restriction
ChanConnPCR:            5333
ChanConnMCR:            2666
ChanConnPercentUti:     100

ChanNumNextAvailable:   63

spirit.1.3.FRSM.a >
```

Example 1-221 Display the connection parameters for the connection on channel 37 on the current VISM

```
spirit.1.5.VISM8.a > dspcon 37

ChanNum:                37
ChanRowStatus:          Add
ChanLocalRemoteLpbkState: Disabled
ChanTestType:           TestOff
ChanTestState:          NotInProgress
ChanRTDresult:          65535 ms
ChanPortNum:            1
ChanPvcType:            VoIP
ChanConnectionType:     PVC
ChanLocalVpi:           0
ChanLocalVci:           1
ChanLocalNSAP:          4e4f44454e414d4500000000000000005000100
ChanRemoteVpi:          58
ChanRemoteVci:          59
ChanRemoteNSAP:         4e4f44454e414d4500000000000000000000100
ChanMastership:         Master
ChanVpcFlag:            Vcc
ChanConnServiceType:    CBR
ChanRoutingPriority:     1
ChanMaxCost:            255
ChanRestrictTrunkType:  No Restriction

Type <CR> to continue, Q<CR> to stop:

ChanConnPCR:            100000
ChanConnPercentUtil:    100

ChanNumNextAvailable:   36

Syntax : dspcon "chan_num"
        channel number -- values : 32 - 255

spirit.1.5.VISM8.a >
```

dspconcnt

Use the **dspconcnt** command to view counter data for the specified connection.

Full Name

Display Connection Counters

Card(s) on Which This Command Executes

PXM

Syntax

dspconcnt <conn_id>

Syntax Description

conn_id Connection identifier, in the format *port.vpi.vci*.

- port range = 1 through *n*, as appropriate for the physical installation.
- vpi range = 1–4095
- vci range = 1–65535

Related Commands

addcon, delcon, dspcon, dspcons

Attributes

Log: No State: Any Privilege: Any

Example 1-222 Display the connection counters for the connection on port 2 with a VPI of 39 and a VCI of 45 on the current PXM

```
spirit4.1.8.PXM.a > dspconcnt 2.39.45

Channel Number           :          17
Channel State            :          alarm
Channel Ingress State    :          alarm
Channel Egress State     :          other
CLP=0 Rcvd. Cells        :             0
CLP=1 Rcvd. Cells        :             0
GCRA1 Non Conforming Cells :             0
GCRA2 Non Conforming Cells :             0
EOF Cells Rcvd.         :             0
CLP=0 Discard Cells      :             0
CLP=1 Discard Cells      :             0
Total Xmtd. Cells        :          7253
CLP=0 Xmtd. Cells        :             0
CLP=1 Xmtd. Cells        :          10867
CLP=0 Discard Cells to Port :             0
CLP=1 Discard Cells to Port :             0

spirit4.1.8.PXM.a >
```

dspcons

Use the **dspcons** PAR command to view details of all connections on the current card.

Full Name

Display Connections

Card(s) on Which This Command Executes

PXM, FRSM, CESM, AUSM, VISM

Syntax

dspcons

Related Commands

dspcon, addcon, delcon

Attributes

Log: No State: Any Privilege: Any

Examples

This section contains the following examples:

- Display parameters for the connections on the current AUSM
- Display parameters for the connections on the current VISM

Example 1-223 Display parameters for the connections on the current AUSM

```
spirit3.1.1.AUSM.a > dspcons

Chan   Port.VPI.VCI   ConnType   Service Type   PCRlot1   Q-Depth   State
30     1.10.100       VCC        ABR            3622      2000      Active
33     1.10.200       VPC        CBR            3622      100       Alarm

spirit3.1.1.AUSM.a >
```

Example 1-224 Display parameters for the connections on the current VISM

```
spirit.1.5.VISM8.a > dspcons

ConnId           ChanNum Status
-----
spirit.5.1.0     37      Add

ChanNumNextAvailable: 35

Syntax : dspcons

spirit.1.5.VISM8.a >
```

dspcurclk

Use the **dspcurclk** command to view the current clock source for the switch.

Full Name

Display Current Clock Source

Card(s) on Which This Command Executes

PXM

Syntax

dspcurclk

Related Commands

dspclksrc, cnfclksrc, dspclkinf

Attributes

Log: No State: Active Privilege: Any

Example 1-225 Display the current clock source for the connections on the current PXM

```
spirit4.1.1.8.PXM.a > dspcurclk

Current Clock Source
-----
Source Node: spirit4

Clock Level: --
Clock Type : INTERNAL

spirit4.1.1.8.PXM.a >
```

dspdsx3bert

Use the **dspdsx3bert** command to view parameters and results of the current BERT testing session.

Full Name

Display DSX3 BERT

Card(s) on Which This Command Executes

FRSM 2T3E3, CESMT3

Syntax

dspdsx3bert

Attributes

Log: No State: Active Privilege: Any

Example 1-226

```

popeye1.1.21.CESMT3.a > dspdsx3bert

Bert Control:                               Acquire dsx3Bert
Bert Resource Status State:                 In Use
Bert Owner:                                 CLI
Bert Status:                                In Sync
Bert Test Medium:                           Line
Bert Port:                                  1
Line Number :                               1
Bert Mode :                                 bertPatternTest
Bert Pattern :                               allOnes
Loopback type:                              metallicLoopback
Start time (secs.)                          Not Configured Yet
Start Date                                   Not Configured Yet
Bit countupper:                              0
Bit countlower:                              0
Bit Error Countupper                         0
Bit Error Countlower                         0
Error Insertion Rate:                        Error injection disabled
Error Insertion count:                       0

          DSX3 BERT in Sync

Syntax : dspdsx3bert

popeye1.1.21.CESMT3.a >

```

dspegrq

Use the **dspegrq** command to view the port egress queue parameters. This command is valid only when the egress quality of service feature is enabled.

Full Name

Display Egress Queue Parameters

Card(s) on Which This Command Executes

FRSM-VHS (2CT3/2T3/2E3/HS2)

Syntax

dspegrqs, dspegrservtype, cnfegrservtype

Attributes

Log: No State: Active Privilege: Any

Example 1-227 Display the port egress queue parameters for port 1

```
golden1.1.1.VHS2CT3.a > dspegrq 1 1

ServicePortNum:          1
Serv Type:               1
Queue Depth:             65535
Queue ECN Threshold:     6553
Queue DE Threshold:      32767
Max Bandwidth Increment: 16384
portBytesDiscXceedQueFull: 0
portBytesDiscXceedDEThresh:0

golden1.1.1.VHS2CT3.a >
```

dspegrqs

Use the **dspegrqs** command to view the egress queue parameters for all the ports on a shelf. This command is valid only when the egress quality of service feature is enabled.

Full Name

Display Egress Queue Parameters

Card(s) on Which This Command Executes

FRSM-VHS (2CT3/2T3/2E3/HS2)

Syntax

dspegrq, dspegrservtype, cnfegrservtype

Attributes

Log: No State: Active Privilege: Any

Example 1-228 Display the egress queue parameters for a shelf

```
golden1.1.1.VHS2CT3.a > dspegrqs 1
```

PortNum	ServType	Q Depth	Q-ECN-Thres	Q-DE-Thres	BandWidth-Inc
1	1	65535	6553	32767	16384
1	2	65535	6553	32767	0
1	3	65535	6553	32767	0
1	4	65535	6553	32767	0

```
golden1.1.1.VHS2CT3.a >
```

dspegrservtype

Use the **dspegrservtype** to display the current egress port queue servicing.

Software Version

Command available with 1.1.20 and higher

Full Name

Display Egress Servicing Type

Card(s) on Which This Command Executes

FRSM-VHS (2CT3/2T3/2E3/HS2)

Syntax

dspegrservtype

Attributes

Log: No State: Active Privilege: Any

dспенetgw

Use the **dспенetgw** command to display the permanent Ethernet gateway. The Ethernet gateway is specified with the **cnfenetgw** command.

Software Version

Command available with 1.1.20 and higher.

Full Name

Display Ethernet Gateway

Card(s) on Which This Command Executes

PXM

Syntax

dспенetgw

Related Commands

cnfenetgw

Attributes

Log: No State: Any Privilege: Any

Example 1-229 Display the default gateway

```
spirit3.1.7.PXM.a > dспенetgw
spirit3.1.7.PXM.a > enet gateway: 172.29.37.1
```

dsperr

Use the **dsperr** command to view the contents of either all error log files or a specific error log file.

Full Name

Display Errors

Card(s) on Which This Command Executes

PXM

Syntax

dsperr [-en <error slot>]

Syntax Description

-en	Command delineator that precedes the <i>error slot</i> entry.
<i>error slot</i>	Number of the error log file (optional).

Attributes

Log: No State: Any Privilege: Any

Examples

This section contains the following examples:

- Display all error log files. The output appears one screen at a time. A prompt appears at the bottom of the screen requesting you to continue to the next screen or quit.
- Display the error log for the card in slot 3. In this example, the card is an FRSM-8T1.

Example 1-230 Display all error log files. The output appears one screen at a time. A prompt appears at the bottom of the screen requesting you to continue to the next screen or quit

```
spirit3.1.7.PXM.a > dsperr

-----
Stack Trace:
  0x801e5714 vxTaskEntry          + c: sysTaskSetup()
  0x80024d2c sysTaskSetup         + 58: rmm_main()
  0x800dff7c rmm_main             +624: rmm_process_message()
  0x800df764 rmm_process_message  + 98: rmm_delete_seat()
  0x800e0f54 rmm_delete_seat     + ac: ipc_remove_seat()
  0x800d1140 ipc_remove_seat     + 50: ipc_renumber_as_slave()
  0x800d0a10 ipc_renumber_as_slave +208: my_free()
  0x800d3430 my_free              + 8: ssiFree()
  0x8001c378 ssiFree              + 8c: ssiEvent()
  0x800274dc ssiEvent             +11c: ssiEvent()
  0x800277bc ssiEvent             +3fc: sysStackTrace()

-----
No Dump Trace before the event
-----
No Dump Trace after the event

Type <CR> to continue, Q<CR> to stop:
-----
Stack Trace:
  0x801e5714 vxTaskEntry          + c: sysTaskSetup()
  0x80024d2c sysTaskSetup         + 58: rmm_main()
  0x800dff7c rmm_main             +624: rmm_process_message()
  0x800df764 rmm_process_message  + 98: rmm_delete_seat()
  0x800e0f54 rmm_delete_seat     + ac: ipc_remove_seat()
  0x800d1140 ipc_remove_seat     + 50: ipc_renumber_as_slave()
  0x800d0a10 ipc_renumber_as_slave +208: my_free()
  0x800d3430 my_free              + 8: ssiFree()
  0x8001c378 ssiFree              + 8c: ssiEvent()
  0x800274dc ssiEvent             +11c: ssiEvent()
  0x800277bc ssiEvent             +3fc: sysStackTrace()

-----
No Dump Trace before the event
-----
No Dump Trace after the event

spirit3.1.7.PXM.a >
```

Example 1-231 Display the error log for the card in slot 3. In this example, the card is an FRSM-8T1

```
spirit3.1.7.PXM.a > dsperr -en 3

Stack Trace:
0x801e5714 vxTaskEntry          + c: sysTaskSetup()
0x80024d2c sysTaskSetup         + 58: rmm_main()
0x800dff7c rmm_main             +624: rmm_process_message()
0x800df764 rmm_process_message  + 98: rmm_delete_seat()
0x800e0f54 rmm_delete_seat     + ac: ipc_remove_seat()
0x800d1140 ipc_remove_seat     + 50: ipc_renumber_as_slave()
0x800d0a08 ipc_renumber_as_slave +200: ipc_remove_ports_on_seat()
0x800d02a8 ipc_remove_ports_on_seat + a0: ipc_remove_port()
0x800d01dc ipc_remove_port     +190: ipc_subsys_init()
0x800cecf0 ipc_subsys_init      +204: my_free()
0x800d3430 my_free             + 8: ssiFree()
0x8001c378 ssiFree             + 8c: ssiEvent()
0x800274dc ssiEvent            +11c: ssiEvent()
0x800277bc ssiEvent            +3fc: sysStackTrace()

-----
No Dump Trace before the event
-----

spirit3.1.7.PXM.a >
```

dspfeature

Use the **dspfeature** command to display features or to change features, such as Channelized and Rate Control. Without parameters, this command acts as a display command.

When the rate control feature is set to ON, the card supports ForeSight. ForeSight is a software feature that provides a closed-loop feedback mechanism for controlling the rate at which users can apply to the network. It improves the efficiency of the network when carrying Frame Relay data, especially during periods of light usage, and maintains consistent performance during peak loading periods without dropping frames. This can be enabled only on an Available Bit Rate (ABR) connection. If the Rate Control feature is OFF, this cannot be enabled.

If the channelized feature is set to ON, it will enable either channelized E1 or channelized T1 for cards that are channelized.

Card	Channelized Feature
FRSM-8T1	Channelized T1
FRSM-8E1	Channelized E1
FRSM-2CT3	Channelized T1
FRSM-2T3/2E3/HS2	No channelized feature on cards

Channelized E1 is an access link operating at 2.048 Mbps. It is subdivided into 30 B-channels and 1 D-channel, supporting DDR, Frame Relays, and x.25.

Channelized T1 is an access link operating at 1.544 Mbps. It is subdivided into 24 channels (23 B-channels and 1 D-channel) of 64 Kbps each. The individual channels or groups of channels connect to different destinations and support DDR, Frame Relay, and x.25. Channelized T1 also is known as fractional T1.

Software Version

Command available with 1.1.20 and higher.

Full Name

Display Feature

Card(s) on Which This Command Executes

FRSM-VHS (2CT3/2T3/2E3/HS2), FRSM-8T1/E1

Syntax

dspfeature [[*feature*] [*enable*]]

Syntax Description

feature One of the following features:

- 375 = channelized
- 193 = rate control

enable Enable or disable feature:

- 97 = ON
- 0 = OFF

Attributes

Log: No State: Any Privilege: Group -2

```
golden1.1.2.VHS2CT3.s > dspfeature
```

```
Channelized: On  
Rate Control: On
```

dspfst

Use the **dspfst** command to view current ForeSight parameter settings for the current service module. See the description of the **cnffst** command for an explanation of the ForeSight parameter settings.

Full Name

Display ForeSight Parameters

Card(s) on Which This Command Executes

FRSM

Syntax

dspfst

Related Commands

cnffst

Attributes

Log: Yes State: Active Privilege: 1-4

Example 1-232 Display the current ForeSight parameter settings for the FRSM-2CT3

```
wilco.1.3.VHS2CT3.a > dspfst

RateUp:          10 percent
RateDown:        87 percent
RateFastDown:    50 percent
QIRTimeout:      10 seconds
RTD:             5 seconds

wilco.1.3.VHS2CT3.a >
```

dspfw

Use the **dspfw** command to view firmware files stored on the hard disk of the MGX 8800 series switch.

Full Name

Display Firmware Revisions

Card(s) on Which This Command Executes

PXM

Syntax

dspfw [*bt*] [*sm* <slot>]

Syntax Description

[bt] Backup boot.

[sm <slot>] Number of the service module slot that needs to be upgraded or downgraded.

Related Commands

None

Attributes

Log: No State: Any Privilege: Any

Example 1-233 Show the firmware versions for the current PXM

```
raviraj.1.7.PXM.a > dspfw
PXM FW versions:

"1.1.10" in pxm_1.1.10.fw
"1.1.11" in pxm_1.1.11.fw
```

dspfwrevs

Use the **dspfwrevs** command to display the current list of firmware revisions on the PXM.

Full Name

Display Firmware Revisions

Card(s) on Which This Command Executes

PXM

Syntax

dspfwrevs

Related Commands

newrev, **printrev**

Attributes

Log: No State: Any Privilege: Any

Example 1-234 Show the current firmware revisions on the selected PXM.

```
raviraj.1.7.PXM.a > dspfwrevs
In dspfwrevs()
Cfg Size      Date          Time          File Name          Card Type      Version
-----
No 1996736 05/06/1999 15:40:24 pxm_gprasann.fw   PXM1E1        gprasann
No 615232 05/10/1999 13:11:36 sm90.fw           CESM-8T1E1
10.0.00_19Apr99_1
No 794572 05/20/1999 18:10:50 sm35.fw           FRSM-8T1E1
10.0.01_18May99_1_rm
No 1983308 04/24/1999 14:18:48 pxm_1.0.00Eh.fw   PXM1E1        1.0.00Eh
N/A 1500292 04/28/1999 14:31:48 pxm_gprasann.fw.working-bcdc PXM1E1        gprasann
No 2089064 06/27/1999 08:12:50 pxm_rmenon.fw     PXM1E1        rmenon
Yes 892356 07/01/1999 15:22:36 sm130.fw          FRSM-2CT3E1
5.0.01_24Jun99_1_raj
No 884404 05/24/1999 11:30:04 smravi.fw         FRSM-2CT3E1
5.0.00_21May99_1_raj

raviraj.1.7.PXM.a >
```

dsphotstandby

Use the **dsphotstandby** command to display service modules in hot standby state. Service modules that are part of a 1:1 redundancy can be in hot standby state. When the secondary service module is introduced, it goes into standby state for a number of minutes, then to hot standby state. For example, an FRSM-VHS module with 4000 connections requires about eight minutes to go from standby state to hot standby state.

In hot standby state, if the active service module fails, the standby service module takes over from the active service module with less than one second of traffic loss. Without the hot standby feature, the delay for a standby service module to take over could be as high as eight minutes, resulting in traffic loss for that period of time.

For the hot standby feature to work, you need a PXM and VHS image that support this functionality, and a FRSM-VHS module. This feature is available in the software version 1.1.20 release, and requires no configuration of the PXM or the service module.

Use **dsphotstandby** in conjunction with **dspred** to view the redundant slot links.

Full Name

Display Hot Standby

Card(s) on Which This Command Executes

PXM

Syntax

dsphotstandby

Related Commands

dspred

Attributes

Log: No State: Any Privilege: Any

Example 1-235 View the current redundant slot links

```
raviraj.1.7.PXM.a > dspred
Primary Primary Primary Secondary Secondary Secondary Red. Red.Slot
SlotNum Type State SlotNum Type State Type Cover
-----
4 FRSM-2CT Standby 10 FRSM-2CT Active 1:1 4
```

Example 1-236 Display the hot standby state for slots 4 and 10

```
raviraj.1.7.PXM.a > dsphotstandby
Slot 4 : Primary SM in HOT STANDBY state.
Slot 10 : Secondary Active SM.
```

Example 1-237 Displaying a service module in slot 4 going from standby into hot standby state

```
raviraj.1.7.PXM.a > dsphotstandby  
Slot 4 : Primary SM not in Hot Standby state.  
Slot 10 : Secondary Active SM.
```

dspif

Use the **dspif** command to view configuration and state information for a broadband interface.

Full Name

Display Interface

Card(s) on Which This Command Executes

PXM

Syntax

dspif <if_num>

Syntax Description

if_num Interface number, in the range 1–32.

Related Commands

cnfif

Attributes

Log: No State: Any Privilege: Any

Example 1-238 Display configuration and state information for broadband interface number 1

```
spirit3.1.7.PXM.a > dspif 1  
  
ifNum  Status  Line  ingrPctBw  egrPctBw  minVpi  maxVpi  
-----  
1      Ena      1      10         10         0       19  
  
spirit3.1.7.PXM.a >
```

dspifcnt

Use the **dspifcnt** command to view interface counters for a broadband interface.

Full Name

Display Interface Counter

Card(s) on Which This Command Executes

PXM

Syntax

dspifcnt <*if_num*>

Syntax Description

if_num Interface number, in the range 1–32.

Related Commands

cnfifcnt

Attributes

Log: No State: Any Privilege: Any

Example 1-239 Display counters and state information for broadband interface number 1

```
spirit3.1.7.PXM.a > dspifcnt 1

Interface Num           :           1
Interface State         : Line Failure
Total Cells             :           0
Received RM Cells      :           0
Received OAM Cells     :           0
Received CLP0 Cells    :           0
Received CLP1 Cells    :           0
Received CLP0,Discarded Cells :       0
Received CLP1,Discarded Cells :       0
Transmitted OAM Cells  :           0
Transmitted RM Cells   :           0
Transmitted CLP0 Cells :           0
Transmitted CLP1 Cells :           0

wilco.1.7.PXM.a >
```

dspifip

Use the **dspifip** command to view all configured interface IP addresses on the current PXM, as well as their status. The possible interfaces are Ethernet, SLIP, and ATM. Data displayed for the SLIP interface will be displayed when the interface is enabled using the **cnfifip** command; for example:

```
cnfifip slip on
```

Software Version

New feature (displays the state of each interface) available with 1.1.12 and higher.

Full Name

Display Interface IP Configuration

Card(s) on Which This Command Executes

PXM

Syntax

dspifip

Related Commands

cnfifip, **delifip**

Attributes

Log: NoState: AnyPrivilege: Any

Example 1-240 Display the IP LAN configuration

```
spirit3.1.7.PXM.a > dspifip
Interface      Flag  IP Address      Subnetmask      Broadcast Addr
-----
Ethernet/lnPci0  UP    172.29.37.77    255.255.255.0   172.29.37.255
SLIP/sl0        DOWN  172.29.36.253  255.255.255.252 (N/A)
ATM/atm0        UP    192.9.200.1     255.255.255.128 0.0.0.0

spirit3.1.7.PXM.a >
```

dspifrc

Use the **dspifrc** command to view all resource partition information for the specified interface.

Full Name

Display Interface Resource Partition

Card(s) on Which This Command Executes

PXM

Syntax

dspifrc <*if_num*>

Syntax Description

if_num Interface number, in the range 1–32.

Related Commands

dspif

Attributes

Log: No State: Any

Privilege: Any

Example 1-241 Display the resource partition information for all controller types on broadband interface 1

```
POP1.1.7.PXM.a > dspifrc 1
```

bbIfNum	Ctrlr	Status	ingrPctBw	egrPctBw	minVpi	maxVpi	minVci	maxVci	maxChans
1	PAR	Mod	100	100	1	2000	0	65535	2000
1	PNNI	Ena	100	100	1	2000	0	65535	32767
1	TAG	Ena	100	100	1	2000	0	65535	32767
1	SVC	Dis	0	0	0	0	0	0	0

```
POP1.1.7.PXM.a >
```

dspifs

Use the **dspifs** command to view the current list of configured broadband interfaces.

Full Name

Display List of Broadband Interfaces

Card(s) on Which This Command Executes

PXM

Syntax

dspifs

Related Commands

upif, cnfif

Attributes

Log: No State: Any

Privilege: Any

Example 1-242 Display configuration and state information for all the broadband interfaces on the current PXM. In the response below, only broadband interface number 1 exists on the current PXM.

```
POP1.1.7.PXM.a > dspifs

  ifNum  Status  Line  ingrPctBw  egrPctBw  minVpi  maxVpi
-----
      1    Ena      1       10        10         0       19

POP1.1.7.PXM.a >
```

dspilmi

Use the **dspilmi** command to view the interim local management interface (ILMI) configuration.

Full Name

Display ILMI

Card(s) on Which This Command Executes

PXM, AUSM

Syntax

dspilmi <port_num>

Syntax Description

port_num Port number, in the range 1–32.

Related Commands

cnfilmi, **dspilmicnt**

Attributes

Log: No State: Active Privilege: Any

Examples

This section contains the following examples:

- Display the ILMI configuration for port 1 on the AUSM
- Display the ILMI configuration for port 1 on the PXM

Example 1-243 Display the ILMI configuration for port 1 on the AUSM

```
spirit3.1.20.AUSM.a > dspilmi 1

Port Num:                1
Signalling:              No signalling
SignallingVPI:           0
SignallingVCI:           0
ILMITrap:                Disabled
ILMI-Min-Trap-Interval (secs): 1
KeepAlivePolling:       Disabled
ErrorThreshold:         3
EventThreshold:         4
PollingInterval (secs): 30
MinimumEnquiryInterval (secs): 10
EXT Operation:          port 2

spirit3.1.20.AUSM.a >
```

Example 1-244 Display the ILMI configuration for port 1 on the PXM

```
spirit3.1.7.PXM.a > dspilmi 1
```

Sig. Port	Ilmi State/Type	Sig Vpi	Sig Vci	Ilmi Trap/Int	KA	T491 ErrTh/Pollint	T492 EvntTh	T493 EnqInt	Addr Reg.
1	Off/none	0	16	Off/01	Off	3/v6	4	10	Off

```
spirit3.1.7.PXM.a >
```

dspilmicnt

Use the **dspilmicnt** command to view the ILMI counters.

Full Name

Display ILMI Counters

Card(s) on Which This Command Executes

PXM, AUSM

Syntax

dspilmicnt <port_num>

Syntax Description

port_num Port number, in the range 1–32.

Related Commands

cnfilmi, **dspilmi**

Attributes

Log: No State: Any Privilege: Any

Example 1-245 Display the ILMI counters for port 1 on the current AUSM card

```
spirit3.1.20.AUSM.a > dspilmicnt 1

  Port Num:                1
  SNMPPDUReceived:        0
  Get RequestsReceived:    0
  GetNextRequestsReceived: 0
  SetRequestsReceived:    0
  TrapReceived:           0
  GetResponseReceived     0
  GetResponseTransmitted: 0
  GetRequestTransmitted:  0
  TrapsTransmitted:       0
  InvalidPDUReceived:     0
  AsnlParseError:         0
  NoSuchNameError:        0
  TooBigError:            0

spirit3.1.20.AUSM.a >
```

dspilmis

Use the **dspilmis** command to view all interim local management interface (ILMI) configurations on the PXM.

Full Name

Display All ILMI Configurations

Card(s) on Which This Command Executes

PXM

Syntax

dspilmis

Related Commands

cnfilmi, dspilmi, dspilmicnt

Attributes

Log: No State: Any Privilege: Any

Example 1-246 Display the ILMI configuration for all ports on the PXM

```
spirit3.1.7.PXM.a > dspilmis

Sig.   Ilmi   Sig  Sig   Ilmi           T491       T492  T493  Addr
Port  State/Type  Vpi  Vci  Trap/Int      KA  ErrTh/Pollint  EvntTh  EnqInt  Reg.
-----
   1  Off/none    0   16  Off/01      Off   3/v6           4       10    Off

spirit3.1.7.PXM.a >
```

dspimagrp

Use the **dspimagrp** command to view delay and resilient links inverse multiplexing ATM (IMA) parameters on the current AUSM card.

Full Name

Display IMA Group

Card(s) on Which This Command Executes

AUSM

Syntax

dspimagrp <*aimux_grp*>

Syntax Description

aimux_grp AIMUX group number, in the range 1–8.

Related Commands

cnfimagrps, dspimagrps, dspimagrpent

Attributes

Log: No State: Active Privilege: 1

Example 1-247 Display all the detailed status and configuration information for AIMUX group 1 on the current card

```
spirit.1.19.AUSM8.a > dspimagrp 1

IMA Group number           : 1
Port type                   : NNI
Lines configured           : 1.2.3
Enable                      : Enabled
IMA Port state              : Sig. Failure
IMA Group Ne state         : Startup
PortSpeed (cells/sec)      : 13470
GroupTxAvailCellRate (cells/sec) : 0
ImaGroupTxFrameLength(cells) : 128
LcpDelayTolerance (IMA frames) : 1
ReadPtrWrPtrDiff (cells)   : 4
Minimum number of links    : 2
MaxTolerableDiffDelay (msec) : 200
Lines Present              :
ImaGroupRxImaId            : 0x100
ImaGroupTxImaId            : 0x0
Observed Diff delay (msec) : 0
Clock Mode                  : CTC
GroupAlpha                  : 2
GroupBeta                   : 2
GroupGamma                  : 1
GroupConfiguration         : 1
IMAGrp Failure status      : Ne StartUp
Timing reference link       : 1
```

```
Syntax : dspimagrp (or dspaimgrp) "imagroup_number"
        IMA group number -- value ranging from 1 to 8
```

```
spirit.1.19.AUSM8.a >
```

dspimagrpcnt

Use the **dspimagrpcnt** command to view inverse multiplexing ATM (IMA) counters on the current AUSM card for all IMA groups.

Full Name

Display IMA Group Counters

Card(s) on Which This Command Executes

AUSM

Syntax

dspimagrpcnt <imagroup>

Syntax Description

imagroup AIMUX group number, in the range 1–8.

Related Commands

dspimagrps, dspimagrpcnt, dspimagrps, dspimainfo, dspimalncnt

Attributes

Log: No State: Active Privilege: 1

Example 1-248 Display all the detailed status and configuration information for the IMA counters for AIMUX group 1 on the current card

```
spirit.1.19.AUSM8.a > dspimagrpcnt 1

IMA Group number:                1
Ne Number of failures             : 0

spirit.1.19.AUSM8.a >
```

dspimagrps

Use the **dspimagrps** command to view inverse multiplexing ATM (IMA) parameters for AUSM.

Full Name

Display IMA Groups

Card(s) on Which This Command Executes

AUSM

Syntax

dspimagrps

Related Commands

dspimagrps, cnfimagrps, dspimainfo, dspimagrpcnt

Attributes

Log: No State: Active Privilege: 1

Example 1-249 Display all the IMA parameter information for all AIMUX groups on the current card

```
spirit.1.19.AUSM8.a > dspimagrps

List of IMA groups:
=====

ImaGrp PortType Speed Lines configured Lines present Tol Diff Port State
-----
19.1 NNI 13470 1.2.3 200 Sig. Failure

NextPortNumAvailable: 8

spirit.1.19.AUSM8.a >
```

dspimainfo

Use the **dspimainfo** command to view information about inverse multiplexing ATM (IMA) parameters on the current AUSM card.

Full Name

Display AIM (or Display IMA) Information

Card(s) on Which This Command Executes

AUSM

Syntax

dspimainfo

Related Commands

dspimagrp, cnfimagr

Attributes

Log: No State: Active Privilege: 1

Example 1-250 Display all the IMA parameter information for all AIMUX groups on the current card

```
spirit.1.19.AUSM8.a > dspimainfo
```

Link	NeTx State	NeRx State	TxId	RxID
1	(null)	(null)	0	0
2	(null)	(null)	0	0
3	(null)	(null)	0	0
4	(null)	(null)	0	0
5	(null)	(null)	0	0
6	(null)	(null)	0	0
7	(null)	(null)	0	0
8	(null)	(null)	0	0

```
spirit.1.19.AUSM8.a >
```

dspimalncnt

Use the **dspimalncnt** command to view current AIMUX line counters for the specified line in an IMA trunk.

Full Name

Display AIM (or Display IMA) Line Count

Card(s) on Which This Command Executes

AUSM

Syntax

dspaimlncnt *<imagroup>* *<linenum>*

Syntax Description

imagroup AIMUX group number, in the range 1–8.

linenum AIMUX line number, in the range 1–8.

Related Commands

clraimlncnt, clrimlncnt, dspaimlncnt

Attributes

Log: No State: Active Privilege: 1

Example 1-251 Display the line counters for line 1 of IMA group 1

```
spirit.1.19.AUSM8.a > dspimalncnt 1 1

IMA group number           : 1
Line number                 : 1
Acp Cells Received         : 0
Acp Errored Cells Recvd    : 0
Port changed from LDS      : 0
# HEC errored cells        : 0
# HEC errored seconds      : 0
# Severely HEC errored seconds : 0

Syntax : dspimalncnt (or dspaimlncnt) imagroup linenum
        IMA group number -- value ranging from 1 to 8
        line number -- value ranging from 1 to 8.

spirit.1.19.AUSM8.a >
```

dsplink

Use the **dsplink** command to view a link on a T3 line on an SRM-3T3 card.

Full Name

Display Link

Card(s) on Which This Command Executes

PXM

Syntax

dsplink <T3 line number>

Syntax Description

T3 line number SRM-3T3 T3 line number, in the format *slot.line*.

- Slot = enter the value 15 or 31
- Line range = 1–3

Related Commands

dellink, addlink

Attributes

Log: No State: Active Privilege: 1

System Response

T3Line	StartT	TRowStatus	TargetSlot	TargetSlotLine
1	1	Add	7	1
1	2	Add	7	2
1	3	Add	7	3
1	4	Add	7	4

dsplmiloop

Use the **dsplmiloop** command to view the current local management interface (LMI) configurations. The command displays the LMI loop status as present or not present for the feeder trunk. This command can be used only if a feeder trunk exists.

Full Name

Display LMI Loop

Card(s) on Which This Command Executes

PXM

Syntax

dsplmiloop

Related Commands

cnfilmi, dspilmi, dspilmicnt, dspilmis, addlmiloop, dellmiloop

Attributes

Log: No State: Any Privilege: Any

Examples

The example that follows illustrates:

- 1 The display feeder trunk command showing that a feeder trunk is configured on the PXM.
- 2 The display LMI loop command, indicating that no LMI loop exists.

Example 1-252 Display Feeder Trunk, Display LMI Loop

```

NAME.1.7.PXM.a > dsptrks
TRK          Current Alarm Status      Other End

7.1          CLEAR                      pswbpx1

NODENAME.1.7.PXM.a > dsplmiloop
TRK          IN LMI LOOP
-----
7.1          No

```

The example that follows illustrates:

- 1 The add LMI loop command adding an LMI loop configuration to the PXM.
- 2 The display LMI loop command showing that an LMI loop is present.

Example 1-253 Add LMI Loop, Display LMI Loop

```
NODENAME.1.7.PXM.a > addlmiloop 7.1
```

```
NODENAME.1.7.PXM.a > dsplmiloop
```

```
TRK      IN LMI LOOP
```

```
-----
```

```
7.1      Yes
```

dsplmistats

Use the **dsplmistats** command to view the current local management interface (LMI) configurations.

Full Name

Display All LMI Statistics

Card(s) on Which This Command Executes

PXM

Syntax

dsplmis

Related Commands

cnfilmi, dspilmi, dspilmicnt, dspilmis

Attributes

Log: No State: Any Privilege: Any

Example 1-254 Display the LMI statistics for the PXM

```
spirit4.1.1.8.PXM.a > dsplmistats

Enabled          :          1  Port Status      :          0
VPI.VCI         :          3.31
Polling enable   :          1
T393            :          10  N394         :          5
T394            :          10  N395         :          5
WaitStatus      :          0  WaitStAck    :          0
Retry Timer     :          0  Retry Count  :          0
Poll Timer      :          0  Trans Num    :          0
Status Rx      :          0  Status Tx    :          0
UpdtStatus Rx  :          0  UpdtStatus Tx :          0
Status Enq Rx  :          0  Status Enq Tx :          0
Status Ack Rx  :          0  Status Ack Tx :          0
NodeStatus Rx  :          0  NodeStatus Tx :        18329
NodeStaAck Rx  :          0  NodeStaAck Tx :          0
Bad PDU Rx     :          0  Bad PDU Len Rx :          0
Unknown PDU Rx :          0  Invalid I.E. Rx:          0
Invalid Trans   :          0
BPX IP Addr    :   172.1.1.215

spirit4.1.1.8.PXM.a >
```

dspln

Use the **dspln** command to view the characteristics of a specified physical line. When the current card is a PXM, you must specify the line type:

- ds3 if the PXM has a T3 line module
- e3 if the PXM has an E3 line module
- SONET if the PXM has an OC-3 or OC-12 line module

Full Name

Display Line

Card(s) on Which This Command Executes

PXM, FRSM, AUSM, CESM

Syntax: PXM

dspln <-ds3 | -e3 | -sonet> <LineNum>

Syntax Description

-ds3	Command delineator that precedes the <i>line number</i> entry for a T3 line.
-e3	Command delineator that precedes the <i>line number</i> entry for an E3 line.
-sonet	Command delineator that precedes the <i>line number</i> entry for a SONET line.
<i>LineNum</i>	Line number in the format <i>slot.line</i> . Slot = enter a value from the range 7, 8, 15, 16, 31, or 32. Line range = 1– <i>n</i> as appropriate for the interface.

Note Set line number value at 7 or 8 if the line type is SONET.

Syntax: FRSM, AUSM, CESM, VISM

dspln <*line_num*>

Syntax Description

line_num Line number, in the range 1–*n* as appropriate for the card.

Related Commands

addln, cnfln, delln

Attributes

Log: No State: Active on PXM, any state on service modules Privilege: Any

Examples

This section contains the following examples.

- Display line 2 on the current AUSM card
- Display T3 line 1 on the current PXM (BNC-2T3)
- Display OC-3 line 1 on the current PXM
- Display line 3 on the current FRSM card

Example 1-255 Display line 2 on the current AUSM card

```
spirit3.1.20.AUSM.a > dspln 2

LineNum:                2
LineConnectorType:      BNC
LineType:                dsx1E1CAS
LineEnable:             Enabled
LineCoding:             dsx1HDB3
LineLength:             G.703 75 ohm
LineXmtClockSource:     LocalTiming
LineLoopbackCommand:    NoLoop
LineSendCode:           NoCode
LineUsedTimeslotsBitMap: 0xffffffff
ConfigChangePortBitMap: 0x0

LineNumOfValidEntries: 4

spirit3.1.20.AUSM.a >
```

Example 1-256 Display T3 line 1 on the current PXM (BNC-2T3)

```
spirit3.1.7.PXM.a > dspln -ds3 7.1

LineNum:                1
LineType:                dsx3CbitParity
LineCoding:             dsx3B3ZS
LineLength:             lessThan225
LineOOFCriteria:        fBits3Of8
LineAIScBitsCheck:     Check C-bits
LineLoopbackCommand:    NoLoop
LineRcvFEACValidation: 4 out of 5 FEAC codes
LineEnable:             Disable

spirit3.1.7.PXM.a >
```

Example 1-257 Display OC-3 line 1 on the current PXM

```
spirit3.1.7.PXM.a > dspln -sonet 7.1

sonetLineNum:          1
sonetLineType:         sonetSts3c
sonetLineLoopback:    NoLoop
sonetHCSmasking:      Enabled
sonetPayloadScramble: Enabled
sonetFrameScramble:   Enabled
sonetLineEnable:      Disable
sonetMediumType:      sonet
sonetMediumTimeElapsed: 0
sonetMediumValidIntervals: 0
sonetMediumLineCoding: NRZ
sonetMediumLineType:  LongSingleMode
sonetMediumCircuitIdentifier: Sonet Line

spirit.1.8.PXM.a >
```

Example 1-258 Display line 3 on the current FRSM card

```
spirit3.1.3.FRSM.a > dspln 3

LineNum:              3
LineConnectorType:   RJ-48
LineType:             dsx1E1CLEAR
LineEnable:          Enabled
LineCoding:          dsx1HDB3
LineLength:          G.703 120 ohm
LineXmtClockSource:  LocalTiming
LineLoopbackCommand: NoLoop
LineSendCode:        NoCode
LineUsedTimeslotsBitMap: 0xffffffff
LineLoopbackCodeDetection: codeDetectDisabled
LineBertEnable:      Disable

LineNumOfValidEntries: 8

Syntax : dspln "line_num"
        line number -- values ranging from 1-8 are accepted, for FRSM_8

spirit3.1.3.FRSM.a >
```

dsplnrsc

Use the **dsplnrsc** command to view the resource partition information for a specified line on the PXM.

Full Name

Display Line Resource

Card(s) on Which This Command Executes

PXM

Syntax

dsplnrsc <line_num>

Syntax Description

line_num Line number, in the range 1–*n*, as appropriate for the physical installation.

Related Commands

addrscrtn, cnfrscrtn

Attributes

Log: No State: Any

Privilege: Any

Example 1-259 Display partition information for line 1 on the current PXM

```
spirit.1.7.PXM.a > dsplnrsc 1

ifNum  Status  Line  ingrPctBw  egrPctBw  minVpi  maxVpi
-----
      1      1      1           100         100         0    4095

spirit.1.7.PXM.a >
```

dsplns

Use the **dsplns** command to view the configuration for all lines on the current card. On the PXM, you must specify the line type.

Full Name

Display Lines

Card(s) on Which This Command Executes

PXM, FRSM, AUSM, CESH, VISM

Syntax

On all cards other than a PXM, enter **dsplns** without arguments.

On a PXM:

```
dsplns <LineTable> <slot>
```

Syntax Description

LineTable Line type = enter ds3, or e3, or SONET.

Use the **dsplcd** command to view line types.

slot Slot number = enter a value from the range 7, 8, 15, 16, 31, or 32.

Related Commands

addln, cnfln, delln, dspcds, dspln

Attributes

Log: No State: PXM: Active. Others: Any Privilege: Any

Examples

This section contains the following examples:

- Display lines on the current FRSM (8T1) card
- Display lines on the current FRSM HX1/B card
- Display lines on the current PXM with BNM-T3E3 trunk card
- Display lines on the current AUSM
- Display lines on the PXM with OC-3
- Display lines on the PXM with OC-12

Example 1-260 Display lines on the current FRSM (8T1) card

```
spirit3.1.3.FRSM.a > dsplns
```

Line	Conn Type	Type	Status/Coding	Length	XmtClock Source	Alarm	Stats Alarm
3.1	RJ-48	dsx1ESF	Dis/dsx1B8ZS	0-131 ft	LocalTim		
3.2	RJ-48	dsx1ESF	Dis/dsx1B8ZS	0-131 ft	LocalTim		
3.3	RJ-48	dsx1ESF	Dis/dsx1B8ZS	0-131 ft	LocalTim		
3.4	RJ-48	dsx1ESF	Dis/dsx1B8ZS	0-131 ft	LocalTim		
3.5	RJ-48	dsx1ESF	Dis/dsx1B8ZS	0-131 ft	LocalTim		
3.6	RJ-48	dsx1ESF	Dis/dsx1B8ZS	0-131 ft	LocalTim		
3.7	RJ-48	dsx1ESF	Dis/dsx1B8ZS	0-131 ft	LocalTim		
3.8	RJ-48	dsx1ESF	Dis/dsx1B8ZS	0-131 ft	LocalTim		

```
spirit3.1.3.FRSM.a >
```

Example 1-261 Display lines on the current FRSM HS1/B card

```
poriky.1.14.FRSM.a > dsplns
```

Line	Type	Rate	Status	Alarm
14.1	dte	8192 Kbps	mod	Yes
14.2	dce	8192 Kbps	mod	No
14.3	dte	8192 Kbps	mod	Yes
14.4	dte	48 Kbps	dis	

```
LineNumOfValidEntries: 4
poriky.1.14.FRSM.a >
```

Example 1-262 Display lines on the current PXM with BNM-T3E3 trunk card

```
spirit3.1.7.PXM.a > dsplns ds3 7
```

Line	Type	Coding	Length	Criteria	AIScBitsCheck
1	dsx3CbitParity	Dis / dsx3B3ZS	lessThan225	fBits30f8	Check C-bits
1	dsx3CbitParity	Dis / dsx3B3ZS	lessThan225	fBits30f8	Check

```
C-bitLineNumOfValidEntries: 1
spirit3.1.7.PXM.a >
```

Example 1-263 Display lines on the current AUSM

```
spirit3.1.19.AUSM.a > dsplns
```

Medium	Medium	Medium	Medium	Length	XmtClock Source	Alarm	Stats Alarm
Line	Conn Type	Type	Status/Coding				
19.1	SMB	dsx1E1CCS	Dis/dsx1HDB3	G.703 75 ohm	LocalTim		
19.2	SMB	dsx1E1CCS	Dis/dsx1HDB3	G.703 75 ohm	LocalTim		
19.3	SMB	dsx1E1CCS	Dis/dsx1HDB3	G.703 75 ohm	LocalTim		
19.4	SMB	dsx1E1CCS	Dis/dsx1HDB3	G.703 75 ohm	LocalTim		
19.5	SMB	dsx1E1CCS	Dis/dsx1HDB3	G.703 75 ohm	LocalTim		
19.6	SMB	dsx1E1CCS	Dis/dsx1HDB3	G.703 75 ohm	LocalTim		
19.7	SMB	dsx1E1CCS	Dis/dsx1HDB3	G.703 75 ohm	LocalTim		
19.8	SMB	dsx1E1CCS	Dis/dsx1HDB3	G.703 75 ohm	LocalTim		

```
LineNumOfValidEntries: 8
spirit3.1.19.AUSM.a >
```

Example 1-264 Display lines on the PXM with OC-3

spirit.1.8.PXM.a > **dsplns sonet 7**

Sonet Line	Line Type	Line Status	Line Lpbk	HCS mask	Payload Scramble	Frame Scramble	Medium Time Elapsed	Medium Valid Intvls	Medium Line Coding	Medium Line Type
1	sonet	Dis	NoLoop	Ena	Enabled	Enabled	0	0	NRZ	LongSine
2	sonet	Dis	NoLoop	Ena	Enabled	Enabled	0	0	NRZ	LongSine
3	sonet	Dis	NoLoop	Ena	Enabled	Enabled	0	0	NRZ	LongSine
4	sonet	Dis	NoLoop	Ena	Enabled	Enabled	0	0	NRZ	LongSine

spirit.1.8.PXM.a >

Example 1-265 Display lines on the PXM with OC-12

spirit3.1.7.PXM.a > **dsplns sonet 7**

Sonet Line	Line Type	Line Status	Line Lpbk	HCS mask	Payload Scramble	Frame Scramble	Medium Time Elapsed	Medium Valid Intvls	Medium Line Coding	Medium Line Type
1	sonet	Ena	NoLoop	Ena	Enabled	Enabled	96734	96	Other	LongSingleMode

spirit3.1.7.PXM.a >

dsploads

Use the **dsploads** PAR command to view the connection load at a specified port on the AUSM. This command helps you to determine whether adding more connections is advisable.

The display shows the load in cells per second. The layout of the display is in rows and columns. One column exists for each port, and one row exists for each connection type. If the traffic is exceeding the bandwidth configured for the port, an “overload” message appears at the bottom of the column for the overloaded port.

Full Name

Display Loads

Card(s) on Which This Command Executes

AUSM

Syntax

dsploads

Related Commands

None

Attributes

Log: No State: Active Privilege: Any

Example 1-266 Display the load on the current AUSM

```
spirit3.1.20.AUSM.a > dsploads

Load Display for AUSM ports

                Port 1  Port2   Port3   Port4
                *****
CBR (based on PCR0+1)      0      0      0      0
VBR (based on PCR0+1)      0      0      0      0
ABR (based on MCR)      64000  64000  64000  64000
                -----
Total                    64000  64000  64000  64000

Load Status                OverloadOverloadOverloadOverload

Note: All Cell Rates are multiplied by respective
      Percentage Utilization factors

spirit3.1.20.AUSM.a >
```

dsplog

Use the **dsplog** command to view events and messages logged by the current PXM or FRSM. The most recent events appear at the top of the list. The **dsplog** command displays the MGX 8800 series log. If you enter the command without either of the optional parameters, the system displays the entire log for all cards. Optionally, you can display the log for a particular card or a particular log entry.

Full Name

Display Log

Card(s) on Which This Command Executes

PXM, FRSM

Syntax

```
dsplog -log <EventLog#> -mod <ModuleName> -sev <Severity#> -sl <Slot#> -task <TaskName>
-tge <MM/DD/YYYY-HH:MM:SS> -tle <MM/DD/YYYY-HH:MM:SS>
```

Syntax Description

-log	Command delineator that precedes the <i>EventLog#</i> entry.
<i>EventLog#</i>	Number of the event log item.
-mod	Command delineator that precedes the <i>Module Name</i> entry.
Module Name	Module name.
-sev	Command delineator that precedes the <i>Severity #</i> entry.
Severity #	Severity number.
-sl	Command delineator that precedes the <i>Slot#</i> entry.
<i>Slot#</i>	Slot number that contains the card associated with the event log.
-task	Command delineator that precedes the <i>TaskName</i> entry.
TaskName	Task name.
-tge	Command delineator that precedes the <i>MM/DD/YYYY-HH:MM:SS</i> entry.
<i>MM/DD/YYYY-HH:MM:SS</i>	Month, day, year, hour, minute, second.
-tle	Command delineator that precedes the <i>MM/DD/YYYY-HH:MM:SS</i> entry.
<i>MM/DD/YYYY-HH:MM:SS</i>	Month, day, year, hour, minute, second.

Related Commands

clrlog, **dsplogs**

Attributes

Log: No

State: Any

Privilege: Any

Example 1-267 Display all log files

```
spirit3.1.7.PXM.a > dsplog

dsplog
04/01/70-13:10:03 tRootTask      2 Illegal msg received
04/01/70-13:10:07 aum          1312 local IP address not programmed
03/01/70-20:11:31 smm          1207 slave ack timeout

spirit3.1.7.PXM.a >
```

dsplogs

Use the **dsplogs** command to view information from all event log files.

Full Name

Display Logs

Card(s) on Which This Command Executes

PXM, FRSM

Syntax

dsplogs

Related Commands

clrlog, dsplog

Attributes

Log: No State: Any Privilege: Any

Example 1-268 Display all log files

```
spirit11.1.7.PXM.a > dsplogs

spirit11.1.7.PXM.a > dsplogs
log_file:   C:/LOG/event04.log
            created when 11/08/1998-19:19:58
            error sequence # :      0

log_file:   C:/LOG/event03.log
            created when 11/04/1998-03:34:38
            error sequence # :      0

log_file:   C:/LOG/event02.log
            created when 11/04/1998-03:18:26
            error sequence # :      0

log_file:   C:/LOG/event01.log
            created when 11/04/1998-03:15:22
            error sequence # :      0

spirit11.1.7.PXM.a >
```

dspmaptbl

Use the **dspmaptbl** command to view the numbers assigned to Frame Relay ports or ATM ports on the FRSM or AUSM, respectively.

Full Name

Display Map Table

Card(s) on Which This Command Executes

FRSM, AUSM

Syntax

dspmaptbl

Related Commands

None

Attributes

Log: No

State: Active

Privilege: Any

Examples

This section contains the following examples:

- Display the map table for the current FRSM
- Display the map table for the current AUSM

Example 1-269 Display the map table for the current FRSMspirit3.1.17.FRSM.a > **dspmaptbl**

PortNum	DLCI	ChanNum	LineNum
1	100	69	1
1	101	70	1
1	102	71	1
1	103	72	1
1	104	73	1
1	105	74	1
1	106	75	1
1	107	76	1
1	108	77	1
1	109	78	1
1	110	79	1
1	111	80	1
1	112	81	1
1	113	82	1
1	114	83	1
1	115	84	1
2	100	85	1
2	101	86	1
2	102	87	1
2	103	88	1

spirit3.1.17.FRSM.a >

Example 1-270 Display the map table for the current AUSMspirit3.1.20.AUSM.a > **dspmaptbl**

PortNum	VPI	VCI	ChanNum	Channel Type
1	1	16	16	VCC
1	1	17	17	VCC
1	1	18	18	VCC
1	1	19	19	VCC
1	1	20	20	VCC
1	1	21	21	VCC
1	1	22	22	VCC
1	1	23	23	VCC
1	1	24	24	VCC
1	1	25	25	VCC
1	1	26	26	VCC
1	1	27	27	VCC
1	1	28	28	VCC
1	1	29	29	VCC
1	1	30	30	VCC
1	1	31	31	VCC
1	1	32	32	VCC
1	1	33	33	VCC
1	1	34	34	VCC
1	1	35	35	VCC

spirit3.1.20.AUSM.a >

dspmsgcnt

Use the **dspmsgcnt** command to view the control message counters for the card.

Full Name

Display Control Message Counters

Card(s) on Which This Command Executes

FRSM, AUSM, CESH, VISM

Syntax

dspmsgcnt

Related Commands

clrmsgcnt

Attributes

Log: No State: Any Privilege: Any

Examples

This section contains the following examples:

- Display the control message counters for the current card (an AUSM)
- Display the control message counter for the current card (a VISM)

Example 1-271 Display the control message counters for the current card (an AUSM)

```
spirit.1.19.AUSM8.a > dspmsgcnt

RiscXmtCtrlMsg:          88006
RiscRcvCtrlMsg:         53494
SARXmtCtrlMsg:          88006
SARRcvCtrlMsg:         53494
SARCtrlMsgDiscLenErr:    0
SARCtrlMsgDiscCRCErr:   0
SARCtrlMsgDiscUnknownChan: 0
SARCtrlMsgLastUnknownChan: 0

spirit.1.19.AUSM8.a >
```

Example 1-272 Display the control message counter for the current card (a VISM)

```
spirit.1.5.VISM8.a > dspmsgcnt

RiscXmtCtrlMsg:          83606
RiscRcvCtrlMsg:          83606
SARXmtCtrlMsg:           83445
SARRcvCtrlMsg:           83606
SARCtrlMsgDiscLenErr:    0
SARCtrlMsgDiscCRCErr:    0
SARCtrlMsgDiscUnknownChan: 0
SARCtrlMsgLastUnknownChan: 0

spirit.1.5.VISM8.a >
```

dspname

Use the **dspname** PAR command to view the name of the node.

Full Name

Display Name

Card(s) on Which This Command Executes

PXM

Syntax

dspname

Attributes

Log: No

State: Active

Privilege: Any

Example 1-273

```
wilco.1.7.PXM.a > dspname
```

```
Node Name : wilco
```

```
wilco.1.7.PXM.a >
```

dspnwip

Use the **dspnwip** PAR command to view the network IP address for the switch.

Full Name

Display Network IP Address

Card(s) on Which This Command Executes

PXM

Syntax

dspnwip

Related Commands

cnfnwip

Attributes

Log: No

State: Active

Privilege: Any

Example 1-274 Display the network IP address for the switch

```
wilco.1.7.PXM.a > dspnwip
```

```
Node IP : 192.0.0.0
```

```
wilco.1.7.PXM.a >
```

dsपोamlpbk

Use the **dsपोamlpbk** command to display the status of an OAM loopback test. The display indicates the PVCs currently under OAM loopback alarm, and the transmission rate of the OAM loopback cells.

Full Name

Display OAM Loopback

Card(s) on Which This Command Executes

FRSM 2T3/E3, FRSM HS2

Syntax

dsपोamlpbk

Related Commands

cnfoamlpbk

Attributes

Log: No State: Any Privilege: Any

Example 1-275 Display loopback command without loopback configured on module

```
popeye1r.1.17.VHS2CT3.s > dsपोamlpbk
```

```
RasOamlpbkAllowedState: Disabled
RasOamlpbkFrequency   : 1
```

Channels

```
16  : 0000000000 0000000000 0000000000 0000000000
56  : 0000000000 0000000000 0000000000 0000000000
96  : 0000000000 0000000000 0000000000 0000000000
136 : 0000000000 0000000000 0000000000 0000000000
176 : 0000000000 0000000000 0000000000 0000000000
216 : 0000000000 0000000000 0000000000 0000000000
256 : 0000000000 0000000000 0000000000 0000000000
296 : 0000000000 0000000000 0000000000 0000000000
336 : 0000000000 0000000000 0000000000 0000000000
376 : 0000000000 0000000000 0000000000 0000000000
416 : 0000000000 0000000000 0000000000 0000000000
456 : 0000000000 0000000000 0000000000 0000000000
496 : 0000000000 0000000000 0000000000 0000000000
536 : 0000000000 0000000000 0000000000 0000000000
```

Example 1-276 Display loopback command with loopback configured on channels 17 and 18

```
popelr.1.17.VHS2CT3.a > dsपोamlpbk
```

```
RasOamlpbkAllowedState: Enabled  
RasOamlpbkFrequency : 2
```

```
Following Channels are under Ras Alarm :
```

```
Channels
```

```
16 : 0000000000 0000000000 0000000000 0000000000  
56 : 0000000000 0000000000 0000000000 0000000000  
96 : 0000000000 0000000000 0000000000 0000000000  
136 : 0000000000 0000000000 0000000000 0000000000  
176 : 0000000000 0000000000 0000000000 0000000000  
216 : 0000000000 0000000000 0000000000 0000000000  
256 : 0000000000 0000000000 0000000000 0000000000  
296 : 0000000000 0000000000 0000000000 0000000000  
336 : 0000000000 0000000000 0000000000 0000000000  
376 : 0000000000 0000000000 0000000000 0000000000  
416 : 0000000000 0000000000 0000000000 0000000000  
456 : 0000000000 0000000000 0000000000 0000000000  
496 : 0000000000 0000000000 0000000000 0000000000  
536 : 0000000000 0000000000 0000000000 0000000000
```

dsponoff

Use the **dsponoff** command to view all parameters activated by the **onoff** command for the current PXM.

Full Name

Display Onoff Command Settings

Card(s) on Which This Command Executes

PXM

Syntax

dsponoff

Related Commands

onoff

Attributes

Log: No State: Active Privilege: 2

Example 1-277 Display all the parameters activated by the onoff command for the current PXM

```
spirit4.1.8.PXM.a > dsponoff

 1 Background Updates          NO
 2 Dynamic BW Allocation       YES
 3 Cm Updates                  YES
 4 Cm_Rerouting               YES
 5 Comm Fail Test              YES
 6 Deroute Delay               YES
 7 Auto Renum Fail Recov      YES

spirit4.1.8.PXM.a >
```

dspparifs

Use the **dspparifs** PAR command to view all Portable AutoRoute (PAR) interfaces for the current PXM.

Full Name

Display PAR Interfaces

Card(s) on Which This Command Executes

PXM

Syntax

dspparifs

Related Commands

None

Attributes

Log: No

State: Active

Privilege: Any

Example 1-278 Display all the PAR interfaces for the current PXM

```
spirit.1.7.PXM.a > dspparifs
```

slot.port	type	status	vpi	vci	txRate	rxRae
7.1	UNI_IF	FAILED	0 to 4095	0 to 65535	96000	9600
0.33	CLK_IF	FAILED	0 to 0	0 to 0	0	0
7.33	UNI_IF	UP	0 to 255	0 to 65535	176604	17664
7.34	UNI_IF	UP	0 to 255	0 to 65535	176604	17664

```
spirit.1.7.PXM.a >
```

dspplpp

Use the **dspplpp** command to view the configured Physical Layer Protocol Processor (PLPP) parameters on the current AUSM.

Full Name

Display PLPP

Card(s) on Which This Command Executes

AUSM

Syntax

dspplpp <port number>

Syntax Description

port number Port number, in the range 1–8.

Related Commands

cnfplpp

Attributes

Log: Yes State: Active Privilege: 1

Example 1-279 Display the PLPP parameters for port 1 on the current AUSM card

```
spirit.1.19.AUSM8.a > dspplpp 1

PhysicalPortNumber:      1
CellFraming:             ATM
CellScramble:            Scramble
Plpp Loopback:           No Loopback
Single-bit error correction: Disabled

spirit.1.19.AUSM8.a >
```

dspport

Use the **dspport** command on an FRSM and CESM to view the port configuration for the specified port.

Use the **dspport** command on an AUSM to view the Physical Layer Protocol Processor configuration for the specified port.

Full Name

Display Port

Card(s) on Which This Command Executes

FRSM, AUSM, CESM

Syntax

dspport <port number>

Syntax Description

port number Port number, in the range appropriate for the card.

- FRSM
 - T1 range = 1–192
 - E1 range = 1–248
- AUSM range = 1–8
- CESM range = 1–8

Related Commands

FRSM: **addport**, **cnfport**, **delpport**

AUSM: **upport**, **dnport**

Attributes

Log: No State: Active Privilege: Any

Examples

This section contains the following examples:

- Display the port configuration for port 1 on the current FRSM8-T1.
- Display port 1 on the current AUSM.

Example 1-280 Display the port configuration for port 1 on the current FRSM8-T1

```

popeye.1.17.FRSM.a > dspport 1

SlotNum:                17
PortLineNum:            1
PortNum:                1
PortRowStatus:          Add
PortDs0Speed:           64k
PortDs0ConfigBitMap(1stDS0): 0xffffffff(1)
PortEqueueServiceRatio: 1
PortFlagsBetweenFrames: 1
PortSpeed:              1536kbps
SignallingProtocolType: NoSignalling
AsynchronousMsgs:      UPD_UFS disabled
T391LineIntegrityTimer: 10
T392PollingVerificationTimer: 15
N391FullStatusPollingCounter: 6
N392ErrorThreshold:    3
N393MonitoredEventCount: 4
EnhancedLmi:           Off
PortState:              Active
PortSignallingState:    No Signalling Failure
CLLMEnableStatus:      Disable
CLLMxmtStatusTimer:    0

```

Type <CR> to continue, Q<CR> to stop:

```

portType:                frameRelay
PortIngrPercentUtil:     0
PortEgrPercentUtil:      0
PortOversubscribed:      False
PortSvcStatus:           Disable
PortSvcInUse:            Not In-Use
PortSvcShareLcn:         Card-based
PortSvcLcnLow:           0
PortSvcLcnHigh:          0
PortSvcDlciLow:          0
PortSvcDlciHigh:        0

PortDs0UsedLine1:        0x00ffffff
PortDs0UsedLine2:        0x00ffffff
PortDs0UsedLine3:        0x00ffffff
PortDs0UsedLine4:        0x00000000
PortDs0UsedLine5:        0x00000000
PortDs0UsedLine6:        0x00000000
PortDs0UsedLine7:        0x00000000
PortDs0UsedLine8:        0x00000000
PortNumNextAvailable:    31

```

Example 1-281 Display normal UNI port on the current AUSM-8

```

popeye.1.29.AUSMB8.a > dspport 1

LogicalPortNumber:      1
Port Enable:            UP
Port State:             Line alarm
PortType:               UNI
PhysicalPortNumber:     1
CellFraming:            ATM
CellScramble:           Scramble
Plpp Loopback:          No Loopback
Single-bit error correction: Disabled

```

Example 1-282 Display a port in the IMA group on the current AUSM-8

```
popeye.1.27.AUSMB8.a > dspport 1 (or dspimagrp 1)

IMA Group number           : 1
Port type                  : UNI
Lines configured : 1.2.4
Enable                     : Enabled
IMA Port state             : Active
IMA Group Ne state        : operational
PortSpeed (cells/sec)     : 10773
GroupTxAvailCellRate (cells/sec) : 7182
ImaGroupTxFrameLength(cells) : 128
LcpDelayTolerance (IMA frames) : 1
ReadPtrWrPtrDiff (cells)   : 4
Minimum number of links    : 2
MaxTolerableDiffDelay (msec) : 275
Lines Present              : 1.2
ImaGroupRxImaId           : 0x0
ImaGroupTxImaId           : 0x0
Observed Diff delay (msec) : 0
Clock Mode                 : CTC
GroupAlpha                 : 2
GroupBeta                  : 2
GroupGamma                 : 1
GroupConfiguration        : 1
IMAGrp Failure status     : No Failure
Timing reference link      : 1
```

Example 1-283 Display port 1 on the current FRSM-VHS2CT3

```
golden.1.5.VHS2CT3.a > dspport 1

SlotNum:                5
PortLineNum:            1
PortNum:                1
PortRowStatus:          Add
PortDs0Speed:           64k
PortDs0ConfigBitMap(1stDS0): 0xffffffff(1)
PortEqueueServiceRatio: n/a
PortFlagsBetweenFrames: 0
PortSpeed:              1536 kbps
SignallingProtocolType: NoSignalling
AsynchronousMsgs:      UPD_UFS disabled
T391LineIntegrityTimer: 10 sec
T392PollingVerificationTimer:15 sec
N391FullStatusPollingCounter:6
N392ErrorThreshold:    3
N393MonitoredEventCount: 4
EnhancedLmi:           Off
PortState:              FailedDuetoLineFailure
PortSignallingState:    No Signalling Failure
CLLMEnableStatus:      Disable
CLLMxmtStatusTimer:    40 ms
portType:               frameRelay
portEnhancedSIW:        Disable
PortIngrPercentUtil:    0
PortEgrPercentUtil:    0
PortOversubscribed:    False
PortSvcStatus:          Disable
PortSvcInUse:           Not In-Use
PortSvcShareLcn:        Card-based
PortSvcLcnLow:          0
PortSvcLcnHigh:         0
PortSvcDlciLow:         0
PortSvcDlciHigh:        0

PortNumNextAvailable:   2
```

Example 1-284 Display port 1 on the current FRSM-HS1

```
golden.1.25.FRSM.a > dspport 1

SlotNum:                25
PortNum:                 1
PortRowStatus:          Add
PortEqueueServiceRatio: 1
PortFlagsBetweenFrames: 1
PortSpeed:               48 Kbps
SignallingProtocolType: NoSignalling
AsynchronousUpdates:    dis
T391LineIntegrityTimer: 10
T392PollingVerificationTimer:15
N391FullStatusPollingCounter:6
N392ErrorThreshold:     3
N393MonitoredEventCount: 4
EnhancedLmi:            Off
PortState:               FailedDuetoLineFailure
PortSignallingState:    No Signalling Failure
CLLMEnableStatus:      dis
CLLMxmtStatusTimer:    0
portType:                frameRelay
PortIngrPercentUtil:    0
PortEgrPercentUtil:     0
PortOversubscribed:     False
```

dspportcnt

Use the **dspportcnt** command to view counters for a specified port.

Full Name

Display Port Counters

Card(s) on Which This Command Executes

PXM, FRSM, AUSM, CESM

Syntax

dspportcnt <port number>

Syntax Description

port number Port number, in the range appropriate for the card.

- PXM range = 1–32
- FRSM
 - T1 range = 1–192
 - E1 range = 1–248
 - X.21 range = 1–4
 - HSSI range = 1–2
- CESM
 - T1 range = 1–192
 - E1 range = 1–248
- AUSM range = 1–8

Related Commands

cnfcd, dspcds

Attributes

Log: No State: Any Privilege: Any

Examples

This section contains the following examples:

- Display port counters on port 1 of the current AUSM
- Display port counters on port 1 of the current FRSM
- Display port counters on port 1 of the current PXM

Example 1-285 Display port counters on port 1 of the current AUSM

```
spirit3.1.20.AUSM.a > dspportcnt 1

PortNum:                1
PortState:              Sig. Failure
IngressRcvCells:        0
IngressRcvCellRate (cells/sec): 0
IngressRcvUtilization (percentage): 0
IngressXmtCells:        0
IngressGFCErrorsCells: 0
IngressVpiVciErrCells: 0
IngressUnknownVpiVci: 0x0
IngressRcvClpSetCells: 0
EgressRcvCells:         0
EgressRcvCellRate (cells/sec): 0
EgressRcvUtilization (percentage): 0
EgressXmtCells:         0
EgressXmtCellRate (cells/sec): 0
EgressXmtUtilization (percentage): 0
EgressPortAlarmDiscardCells: 0
EgressXmtClpSetCells:  0
EgressXmtEfciSetCells: 0
PortXmtAisCells:       0
PortXmtSgmtLpbkCells:  0
PortRcvAisCells:       0
PortRcvFerfCells:      0
PortRcvSgmtLpbkCells:  0
PortRcvCrcErrOAMCells: 0
TotalIngressQFullDiscardCells: 0
TotalIngressClpSetDiscardCells: 0
TransmitFIFOFullCount (per card): 0
ReceivedHECErrorsCells: 0
HECErroredSeconds:     0
SeverelyHECErroredSeconds: 0

spirit3.1.20.AUSM.a >
```

Example 1-286 Display port counters on port 1 of the current FRSM

```
spirit3.1.17.FRSM.a > dspportcnt 1
```

	Tx	Rx
	-----	-----
Total Frames:	0	0
Total Bytes:	0	0
Frames FECN:	0	0
Frames BECN:	0	0
Frames Abort:	0	0
Buf Not Available:	0	0
KbpsAIR:	0	0
XmtFramesDiscXceedQDepth:	0	
XmtBytesDiscXceedQDepth:	0	
XmtFramesDuringLMIAAlarm:	0	
XmtByteDuringLMIAAlarm:	0	
XmtFramesUnderrun:	0	
RcvFramesDE:		0
RcvFramesDiscCRCError:		0
RcvFramesDiscIllegalHeader:		0
RcvFramesDiscAlignmentError:		0
RcvFramesDiscIllegalLen:		0
RcvFramesDiscXceedDEThresh:		0
RcvFramesUnknownDLCI:		0
RcvLastUnknownDLCI:		0
RcvFramesTaggedFECN:		0
RcvFramesTaggedBECN:		0
RcvFramesTaggedDE:		0
Status:	0	0
StatusInquiry:	0	0
AsynchUpdate:	0	0
RcvInvalidRequest:		0
RcvUNISegMismatch:		0
RcvNNISegMismatch:		0
UNISignallingTimeout:		0
NNISignallingTimeout:		0
FramesCLLM:	0	0
BytesCLLM:	0	0
CLLMFailures:		0

```
spirit3.1.17.FRSM.a >
```

Example 1-287 Display port counters on port 1 of the current PXM

```
spirit4.1.8.PXM.a > dspportcnt 1
```

```
Interface Num           :           1
Interface State         : Line Failure
Total Cells             :           0
Received OAM Cells      :           0
Received RM Cells       :           0
Received CLP0 Cells     :           0
Received CLP1 Cells     :           0
Received CLP0,Discarded Cells :       0
Received CLP1,Discarded Cells :       0
Transmitted OAM Cells   :           0
Transmitted RM Cells    :           0
Transmitted CLP0 Cells  :      256656
Transmitted CLP1 Cells  :           0
```

```
spirit4.1.8.PXM.a >
```

dspportq

Use the **dspportq** command to view queue information for a specified port and egress queue on the AUSM.

Full Name

Display Port Queue Information

Card(s) on Which This Command Executes

AUSM

Syntax

dspportq <port number> <egress queue number>

Syntax Description

port number Port number, in the range 1–8.

egress queue number Egress queue number, in the range 1–12.

Related Commands

dspportqs

Attributes

Log: No State: Any Privilege: Any

Example 1-288 Display queue information for egress queue 1 on port 1

```
spirit3.1.20.AUSM.a > dspportq 1 1
```

```
ServicePortNum:          1
QueueNumber:             1
PortBinState:            Disable
ServiceSequence:        255
QueueDepth(cells):       500
CLPThresholdHigh(cells): 450
CLPThresholdLow(cells):  400
EFCTThreshold(cells):    400
QueueAlgorithm:         255
MaxBandwidthIncrement:  4096
MinBandwidthIncrement:   0
QCLPState:               Low
QFullDiscardedCells:     0
CLPSetDiscardedCells:   0
```

```
Syntax : dspportq "port_num egress_q"
          port number -- values ranging from 1-8
          queue # -- queue number : 1 - 16, 0 - for default in addchan
```

```
spirit3.1.20.AUSM.a >
```

dspportqs

Use the **dspportqs** command to view queue information for all the egress queues on an AUSM port.

Full Name

Display Port Queue Information

Card(s) on Which This Command Executes

AUSM

Syntax

dspportqs

Related Commands

dspportq

Attributes

Log: No

State: Any

Privilege: Any

Example 1-289 Display egress queue information for all the egress queues on the AUSM

```
spirit.1.19.AUSM8.a > dspportqs
```

Port	Q Num	State	Q-Algo	Service-Seq	Depth-Max	CLP-High	CLP-Low	EFCI-Thrsh
1	1	Enabled	3	1	200	180	160	160
1	2	Enabled	3	2	900	800	700	700
1	3	Enabled	3	3	900	800	700	700
4	1	Enabled	3	1	200	180	160	160
4	2	Enabled	3	2	900	800	700	700
4	3	Enabled	3	3	900	800	700	700

Syntax : dspportqs

dspportrscprtn

Use the **dspportrscprtn** command to view the port resource partition on the current PXM.

Full Name

Display Port Resource Partition Information

Card(s) on Which This Command Executes

PXM

Syntax

dspportrscprtn

Related Commands

dspcdrscprtn, dsplnrsc, dsprscprtn

Attributes

Log: No State: Any Privilege: Any

Example 1-290 Display the port resource partition on the current PXM

```
spirit4.1.8.PXM.a > dspportrscprtn
```

Port Num	Ctrlr Type	Row Stat	PctBw In/Out	VPI min/max	VCI min/max	Max GLCNs
1	PAR	ON	100/100	0/255	0/65535	32767
1	PNNI	ON	100/100	0/255	0/65535	32767
1	TAG	ON	100/100	0/255	0/65535	32767
2	PAR	ON	100/100	0/255	0/65535	32767
2	PNNI	ON	100/100	0/255	0/65535	32767
2	TAG	ON	100/100	0/255	0/65535	32767

```
spirit4.1.8.PXM.a >
```

dsports

Use the **dsports** command to view information about all ports on the current card.

Full Name

Display Ports

Card(s) on Which This Command Executes

PXM, FRSM, AUSM, CESM

Syntax

dsports

Related Commands

addport, cnfport, delport, dsport

Attributes

Log: No

State: Any

Privilege: Any

Examples

This section contains the following examples:

- Display the ports on the current FRSM
- Display the ports on the current PXM
- Display the ports on the current AUSM
- Display the ports on the current CESM

Example 1-291 Display the ports on the current FRSM

```
spirit3.1.17.FRSM.a > dsports
```

Port	Ena/Speed	EQService	SignalType	T391	T392	N391	N392	N393	InAlarm
Ratio									
17.2.1	Add/1536k	1	NoSignalling	10	15	6	3	4	No
17.2.2	Add/ 64k	1	NoSignalling	10	15	6	3	4	No
17.2.3	Add/ 64k	1	NoSignalling	10	15	6	3	4	No
17.2.4	Add/ 64k	1	NoSignalling	10	15	6	3	4	No
17.2.5	Add/ 64k	1	NoSignalling	10	15	6	3	4	No
17.2.6	Add/ 64k	1	NoSignalling	10	15	6	3	4	No
17.2.7	Add/ 64k	1	NoSignalling	10	15	6	3	4	No
17.2.8	Add/ 64k	1	NoSignalling	10	15	6	3	4	No
17.2.9	Add/ 64k	1	NoSignalling	10	15	6	3	4	No
17.2.10	Add/ 64k	1	NoSignalling	10	15	6	3	4	No
17.2.11	Add/ 64k	1	NoSignalling	10	15	6	3	4	No
17.2.12	Add/ 64k	1	NoSignalling	10	15	6	3	4	No
17.2.13	Add/ 64k	1	NoSignalling	10	15	6	3	4	No
17.2.14	Add/ 64k	1	NoSignalling	10	15	6	3	4	No
17.2.15	Add/ 64k	1	NoSignalling	10	15	6	3	4	No
17.2.16	Add/ 64k	1	NoSignalling	10	15	6	3	4	No
17.2.17	Add/ 64k	1	NoSignalling	10	15	6	3	4	No
17.2.18	Add/ 64k	1	NoSignalling	10	15	6	3	4	No
17.2.19	Add/ 64k	1	NoSignalling	10	15	6	3	4	No

Example 1-292 Display the ports on the current PXM

```
pop_oc12.1.8.PXM.a > dsports
```

Port	Status	Line	PctBw	minVpi	maxVpi
1	ON	1	100	0	4095
2	ON	2	100	0	4095

Example 1-293 Display the ports on the current AUSM

```
spirit.1.19.AUSM8.a > dsports
```

No ATM T1/E1 UNI ports currently active

List of IMA groups:
=====

ImaGrp	PortType	Speed	Lines configured	Lines present	Tol Diff	Port State
Delay(ms)						
19.1	NNI	13470	1.2.3		200	Sig. Failure

NextPortNumAvailable: 2

```
spirit.1.19.AUSM8.a >
```

Example 1-294 Display the ports on the current CESM

```
MGX-01.1.1.1.CESM.a > dsports

Port      Ena/Speed  Type
-----
1.1.1    Add/1536k structur

Number of ports:      1

PortDs0UsedLine1:    0x00ffffff
PortDs0UsedLine2:    0x00000000
PortDs0UsedLine3:    0x00000000
PortDs0UsedLine4:    0x00000000
PortDs0UsedLine5:    0x00000000
PortDs0UsedLine6:    0x00000000
PortDs0UsedLine7:    0x00000000
PortDs0UsedLine8:    0x00000000
PortNumNextAvailable: 10

MGX-01.1.1.1.CESM.a >
```

dspportstats

Use the **dspportstats** command to view statistics information for a specified port on the FRSM.

Full Name

Display Port Statistics

Card(s) on Which This Command Executes

FRSM

Syntax

dspportstats <line#> <1st_DS0>

Syntax Description

<i>line#</i>	Line number, in the range 1–8.
<i>1st_DS0</i>	First DS0, in the range appropriate for the interface. <ul style="list-style-type: none">• T1 range = 1–24• E1 range = 1–32

Related Commands

dspchstats

Attributes

Log: No State: Any Privilege: Any

Example 1-295 Display statistics information for port 1 on first DS0 of 12

spirit3.1.17.FRSM.a > dspportstats 1 12

```

Line Num:1
Physical Port Num: 12
Logical Port Num: 4

```

	Tx	Rx
	-----	-----
Total Frames:	0	0
Total Bytes:	0	0
Frames FECN:	0	0
Frames BECN:	0	0
Frames Abort:	0	0
Buf Not Available:	0	0
KbpsAIR:	0	0
XmtFramesDiscXceedQDepth:	0	
XmtBytesDiscXceedQDepth:	0	
XmtFramesDuringLMIAAlarm:	0	
XmtByteDuringLMIAAlarm:	0	
XmtFramesUnderrun:	0	
RcvFramesDE:		0
RcvFramesDiscCRCError:		0
RcvFramesDiscIllegalHeader:		0
RcvFramesDiscAlignmentError:		0
RcvFramesDiscIllegalLen:		0
RcvFramesDiscXceedDEThresh:		0
RcvFramesUnknownDLCI:		0
RcvLastUnknownDLCI:		0
RcvFramesTaggedFECN:		0
RcvFramesTaggedBECN:		0
RcvFramesTaggedDE:		0
Status:	0	0
StatusInquiry:	0	0
AsynchUpdate:	0	0
RcvInvalidRequest:		0
RcvUNISegMismatch:		0
RcvNNISegMismatch:		0
UNISignallingTimeout:		0
NNISignallingTimeout:		0
FramesCLLM:	0	0
BytesCLLM:	0	0
CLLMFailures:		0

spirit3.1.17.FRSM.a >

dspprf

Use the **dspprf** command to view profiler data. The profiler is organized in terms of resources that are being monitored. The data being collected for a particular resource can be of “interval” or “total” nature. If the total option is specified, the last 150 tasks executed, or that are executing, are displayed. If no options are specified, the **dspprf** command shows interval data. Note that the interval is configured using the **cnfprfparam** command.

If the abort option is added to the command, the latest profiler data that is saved during a Controller Card abort is displayed; for example, 1 million 3, 3 million, 2 million 1000, 52, 252. If the profiler is examined without the “abort” (a) option, then the real-time data that is being collected every “x” seconds (configured using **cnfprfparam**) is displayed. By default, the real-time data is collected every 20 seconds.

Full Name

Display Profiler Data

Card(s) on Which This Command Executes

PXM

Syntax

dspprf [t|i] [m|n|r]

Syntax Description

- | | |
|---|--|
| t | Total data collected from the time when the system is initialized. |
| i | Interval data collected every “x” seconds, as specified using the cnfprfparam command. If no options are specified, interval data is displayed. |
| m | Displays memory data. |
| n | Displays node information. |
| r | Displays region usage. |

Related Commands

dspprfhist, cnfprfparam

Attributes

Log: No

State: Active_Only

Privilege: Any

All valid combinations possible with the **dspprf** command are listed below. The [a] and [s] options specify abort or standby data.

- dspprf i m
- dspprf t m
- dspprf i n
- dspprf t n
- dspprf i r
- dspprf t r

Example 1-296 Interval profiler data for memory resources (dspprf i m)

```

NODENAME.1.7.PXM.a > dspprf i m

```

	HP	LP	Free	Assgn
INTERRUPT	0	0	0	0
	0	0	0	0
	0	0	0	0
UNKOWN	0	0	0	0
	0	0	0	0
	0	0	0	0
tRootTask	0	0	0	0
	0	0	0	0
	0	0	0	0
tLOGD	2	0	2	0
	2	0	2	0
	2	0	2	0
tSPM	0	0	0	0
	0	0	0	0
	0	0	0	0
tParRoot	358	0	358	0
	1000	0	1000	0
	1000	0	1000	0
tIpatm	0	0	0	0
	2	0	2	0
	2	0	2	0
tRVT	0	0	0	0
	0	0	0	0
	0	0	0	0
tCliAuthTra	0	0	0	0
	0	0	0	0
	0	0	0	0
tTnInTsk01	28	0	28	0
	1	0	2	0
	20	0	20	0

Data Components

Task names	Task names for the tasks that are spawned. For dynamic tasks, note that task names are repeated since they are spawned, exited, and repeated.
HP	Number of times the task made a high-priority memory allocation.
LP	Number of times the task made a low-priority memory allocation.
Free	Number of times the task made a free memory call.
Assgn	Number of times memory was assigned to this process.

Example 1-297 Total profiler data for memory resources (dspprf t m)

```

NODENAME.1.7.PXM.a > dspprf t m
      Blk      Size      MaxBlk      MaxSz
UNKOWN      204      24896      204      24896
tRootTask    80     5129696      80     5129696
tLOGD        1         80         2         160
tSAR         0          0         0          0
tSCM        201     19296      202     19376
tRPC         2         144         5         400
tDBM        201     192240      232     202656
tDbmDisk     2         160         2         160
tDbmRam      1          80         1          80
tPMM         9          592        12         864
tLDRV        7     459136         9     459312
tOAM         0          0         1     16432
tTFTPD       20     11200        20     11200
tFILED       0          0         0          0
tDbgInTask   8         3200        10         4512
tTelnetD     2          304         6     27296
tRed         7          576        10     1216992
tRMM        2241     267712      2241     267712
tAutoCard    4          272         7          672
tVsmCMM      2          368         3     1216928
tVsmConMgr   25         1808        26     18240
tVsmIlmi     0          0         0          0
      BlkAssgn  AssgnSz  BlkFree  FreeSz  Fail
UNKOWN       0          0         0          0         0
tRootTask    0          0         0          0         0
tLOGD        0          0        2170     173600         0
tSAR         0          0         0          0         0
tSCM         7          560        2923     233840         0
tRPC         2          176         18         1504         0
tDBM         62     20832        121     33680         0
tDbmDisk     0          0         0          0         0
tDbmRam      0          0         0          0         0
tPMM         6          544         5          432         0
tLDRV        2          176         0          0         0
tOAM         0          0         1     16432         0
tTFTPD       0          0         0          0         0
tFILED       0          0         0          0         0
tDbgInTask   21     20032        21     18880         0
tTelnetD     0          0         22     81632         0
tRed         4     1219696      43274     5456384         0
tRMM         0          0         0          0         0
tAutoCard    1          176         2          224         0
tVsmCMM      0          0         4     1216800         0
tVsmConMgr   1     16432         0          0         0
tVsmIlmi     0          0         0          0         0

```

Data Components

Task names	Task names for the tasks that are spawned. Note that some task names are repeated because they are dynamic tasks that are spawned, then exited.
Blks	Number of memory blocks currently owned by the task. Blks provides an approximation of the memory consumption by a task under “normal” circumstances (assuming the command was executed when the node was “normal”). This value should not be negative. A negative value could indicate a preemptive update issue with the statistics.
Size	The total size of memory owned by task, in bytes. This value should not be negative. A negative value could indicate a preemptive update issue with the statistics.
MaxBlks	Maximum number of blocks currently used by a given task. This data helps in debugging memory-related aborts or problems.
MaxSize	Maximum total memory used by a given task.
BlkAssgn	When memory is sent or passed from one task to another task, its ownership is assigned to the task that is receiving the responsibility for the memory. BlkAssign and Assgnl counts keep track of blocks that have been assigned ownership to another task.
AssgnSz	When memory is sent or passed from one task to another task, its ownership is assigned to the task that is receiving the responsibility for the memory. BlkAssign and AssgnSz counts keep track of blocks that have been assigned ownership to another task.
BlkFree	Number of available memory blocks.
FreeSz	Maximum total memory available.
Fails	Number of times memory allocation failed for the task.

Example 1-298 Interval profiler data for node resources (dspprf i n)

Displays statistics on the amount of SAR buffer used for messaging with other cards or nodes.

```

NODENAME.1.7.PXM.a > dspprf in

                Fail      HP      LP
CELL
                0        63      0
                0        63      0
                0        64      0
SMALL
                0         1      0
                0        27      0
                0        27      0
MEDIUM
                0         0      0
                0         0      0
                0         0      0
LARGE
                0         0      0
                0         0      0
                0         0      0

Pk Tx Low(APP->SCM)
                0         0      0
Pk Tx High(APP->SCM)
                0         0      0
Pk Rx Low(SAR->SCM)
                1         1      1
Pk Rx High(SAR->SCM)
                0         0      0

popftx43.1.8.PXM.a >

```

Data Components

CELL	The CELL buffer is the size of one ATM cell.
SMALL	The SMALL buffers are approximately 6 cells of frame payload in size.
MEDIUM	The MEDIUM buffers are approximately 41 cells of frame payload in size.
LARGE	The LARGE buffers are approximately 171 cells of frame payload in size.
Pk Tx Low (APP->SCM)	Represents the interval counts of messages transmitted from the Shelf Control Module (SCM) of Type Low.
Pk Tx High (APP->SCM)	Represents the interval counts of messages transmitted from the Shelf Control Module (SCM) of Type High.
Pk Rx Low (SAR->SCM)	Represents the interval counts of messages received by the Shelf Control Module (SCM) of Type Low.
Pk Rx High (SAR->SCM)	Represents the interval counts of messages received by the Shelf Control Module (SCM) of Type High.
Fail	Indicates how many buffer allocations of that size have failed in the interval.
HP	The high-priority allocation of buffer in the interval.
LP	The low-priority allocation of buffer in the interval.

Example 1-299 Total profiler data for node resources (dspprf tn)

This command displays information about some of the node-wide resources. Currently, message buffers usage for messaging between different processes are stored.

NODENAME.1.7.PXM.a > dspprf tn

Pool Name:	TotlChnk	FreeChnk	LoWatMk	AllocOks	AllcFail	Frees
Nw_Prot_Pkt	100	100	100	0	0	0
Nw_Msg_Ltr	1000	999	999	1	0	0
Cm_SCon_Bmap	10	10	10	0	0	0
Cm_Mcon_Bmap	10	9	9	1	0	0
IPC port info	100	100	100	0	0	0

Data Components

Pool names The following chunk pool names are used in PAR and for IPC to the RPM:

- Nw_Prot_Pkt = Network Protocol Packet
- Nw_Msg_Ltr = Network Message Letter
- Cm_SCon_Bmap = Connection Management Standby Connection Bit map
- Cm_Mcon_Bmap = Connection management Mandatory Connection Bit map
- IPC port info = Interprocess Communication port information

TotlChnk Total number of chunks in a particular memory pool.

FreeChnk The number of chunks currently free.

LoWatMk The low-water mark, which indicates how low the number of free chunks has gone.

AllocOks Allocations OK is the total number of allocations that succeeded.

AllcFail Allocations Fail is the total number of allocation failures.

Frees The number of chunks that have been freed over time.

Example 1-300 Interval profiler data for region resources (dspprf ir)

NODENAME.1.7.PXM.a > dspprf ir

		HP	LP	Fail
STATIC	Smple 0	21	0	0
STATIC	Smple -1	27	0	0
STATIC	Smple -2	22	0	0
DYNAMIC	Smple 0	1057	0	0
DYNAMIC	Smple -1	1057	0	0
DYNAMIC	Smple -2	1061	0	0
STATISTC	Smple 0	0	0	0
STATISTC	Smple -1	0	0	0
STATISTC	Smple -2	0	0	0

Data Components

HP	High-priority allocation to the various regions that succeeded in the interval.
LP	Low-priority allocation to the various regions that succeeded in the interval.
Fail	The high-priority and low-priority allocation failures to the various regions that occurred during the interval.
Static	Static region.
Dynamic	Dynamic region. Note that a high-priority allocation in the dynamic region will go to the static region if necessary. Low-priority allocation in the region is blocked once the amount of free memory goes below a threshold.
Statistic	Statistic region.

Example 1-301 Total profiler data for region resources (dspprf t r)

```

NODENAME.1.7.PXM.a > dspprf tr
                Aval      Fail
STATIC          34649040    0
DYNAMIC         30099744    0
STATISTIC       6078464     0

```

Data Components

Aval	Number of bytes available in the three memory regions.
Fail	Fail represents memory allocations that have failed over time.
Static	Static region.
Dynamic	Dynamic region.
Statistic	Statistic region.

dspprfhist

Use the **dspprfhist** command to view performance history. The history maintains the real-time usage (historical) of all the tasks in the system. It can maintain 120 intervals worth of real-time data before it is overwritten. The actual time then depends on the interval time as configured by **cnfprfparam 1** command (Interval Time). By default, the interval time is 20 seconds. Multiplied by 120 intervals, this would result in $120 * 20 = 2400$ seconds of data. Therefore, you can display 2400 seconds of real-time usage by the different tasks in the system. Unlike the regular **dspprf** screens, this data is NOT saved on an abort.

This command is useful to determine the real-time usage after a particular event. For example, after a CC switchover or a CC rebuild, run **dspprfhist** to view how the real time was being used to recover from the rebuild or switchover.

Full Name

Display Performance History

Card(s) on Which This Command Executes

PXM

Syntax

dspprfhist [*intervals*]

Syntax Description

<i>intervals</i>	Number of samples to display, in the range 1–120
	Default = 10

Related Commands

dspprf, **cnfprfparam**

Attributes

Log: No State: Active_Only Privilege: Any

Example 1-302 View two samples on the current PXM

```

NODENAME.1.7.PXM.a > dspprfhist
CURRENT TIME      19:4:53
Sample #         0
19:4:31(From)-19:4:51(To)
TASK              TaskId          %
-----
INTERRUPT         -             0.2000
KERNEL            -             0.6000
IDLE              -             55.1000
UNKOWN            -             0.1000
tSpmLmi          41             1.4500
tBgndCheck       59             0.0500
tTnCmdTsk01     84             42.2500
tTnOutTsk01     85             0.2500

Sample #        -1
19:4:11(From)-19:4:31(To)
TASK              TaskId          %
-----
INTERRUPT         -             0.2500
KERNEL            -             0.3500
IDLE              -             45.2000
UNKOWN            -             0.2500
tSpmLmi          41             1.4500
PAR:Lmi          53             0.0500
PAR:Netw         56             0.0500
tBgndCheck       59             0.0500
tTnCmdTsk01     84             52.2500
tTnOutTsk01     85             0.1000

Sample #        -2
19:3:51(From)-19:4:11(To)
TASK              TaskId          %
-----
INTERRUPT         -             0.0000
KERNEL            -             0.0000
IDLE              -             98.6000
UNKOWN            -             0.0000
tSpmLmi          41             1.4000

```

Data Components

- Task** The task name that was running.
- Task ID** An ID number assigned to the task that was running.
- %** Utilization percentage. In each sample, only those processes/tasks that are actually being used in the respective time sample are presented with a %utilization, (except for the INTERRUPT, KERNEL, IDLE, UNKNOWN processes/tasks).

dspred

Use the **dspred** command to view the current redundant slot links.

Full Name

Display Redundancy

Card(s) on Which This Card Executes

PXM

Syntax

dspred

Related Commands

addred, delred

Attributes

Log: No State: Active Privilege: Any

Example 1-303 Display the current redundant slot links on the switch

```
spirit.1.7.PXM.a > dspred
```

Primary SlotNum	Primary Type	Primary State	Secondary SlotNum	Secondary Type	Secondary State	Red. Type	Red. Slot Cover
3	FRSM-8T1	Active	4	FRSM-8T1	Standby	1:N	0

```
spirit.1.7.PXM.a >
```

dsprscrptn

Use the **dsprscrptn** command to view the resource partition information for the specified interface.

Full Name

Display Resource Partition

Card(s) on Which This Command Executes

PXM

Syntax

dsprscrptn <if_num> <ctrlr_num>

Syntax Description

if_num Interface Number, in the range 1–32.

ctrlr_num Value to set controller type.

- 1 = PAR
- 2 = PNNI
- 3 = TAG

Related Commands

addrscrptn, **cnfrscrptn**

Attributes

Log: No State: Any

Privilege: Any

Example 1-304 Display resource partition information for the PAR controller on broadband interface 1 on the current PXM

```
MGX-01.1.1.7.PXM.a > dsprscrptn 1 1
```

<u>bbIfNum</u>	<u>Ctrlr</u>	<u>Status</u>	<u>ingrPctBw</u>	<u>egrPctBw</u>	<u>minVpi</u>	<u>maxVpi</u>	<u>minVci</u>	<u>maxVci</u>	<u>maxChans</u>
1	1	Ena	100	100	0	4095	0	65535	32767

```
MGX-01.1.1.7.PXM.a >
```

dsprscprtns

Use the **dsprscprtns** command to view the resource partition information for all the interfaces.

Full Name

Display Resource Partitions

Card(s) on Which This Command Executes

PXM

Syntax

dsprscprtns

Related Commands

addrscprtnt, cnfrscprtnt

Attributes

Log: No State: Any

Privilege: Any

Example 1-305 Display resource partition information for all the broadband interfaces on the current PXM

```
MGX-01.1.7.PXM.a > dsprscprtns
```

<u>bbIfNum</u>	<u>Ctrlr</u>	<u>Status</u>	<u>ingrPctBw</u>	<u>egrPctBw</u>	<u>minVpi</u>	<u>maxVpi</u>	<u>minVci</u>	<u>maxVci</u>	<u>maxChans</u>
1	1	Ena	100	100	0	4095	0	65535	32767

```
MGX-01.1.7.PXM.a >
```

dspsarchans

Use the **dspsarchans** command to view the Segmentation and Reassembly (SAR) channels for the current card.

Full Name

Display SAR channels

Card(s) on Which This Command Executes

PXM

Syntax

dspsarchans

Related Commands

dspchans

Attributes

Log: No

State: Any

Privilege: Any

Example 1-306 Display SAR channels

penguin.1.7.PXM.a > dsparchans

GLCN	SLOT	LCN	RX/TX

Inter-card Channels:			
1	23	0	TX
3	8	2	TX
6	8	2	RX
68	1	2	TX
69	1	2	RX
70	1	3	TX
71	1	3	RX
78	1	7	TX
79	1	7	RX
88	2	2	TX
89	2	2	RX
90	2	3	TX
91	2	3	RX
98	2	7	TX
99	2	7	RX
108	3	2	TX
109	3	2	RX
.	.	.	.
.	.	.	.
.	.	.	.
568	26	2	TX
569	26	2	RX
570	26	3	TX
571	26	3	RX
658	30	7	TX
659	30	7	RX

External Channels:

GLCN	IF	VPI	VCI	RX/TX

720	1	3	31	RX
721	1	3	8	RX
32824	1	3	31	TX
32825	1	3	8	TX

penguin.1.7.PXM.a >

dspsarcnt

Use the **dspsarcnt** command to view the Segmentation and Reassembly (SAR) counters for the current card.

Full Name

Display SAR Counters

Card(s) on Which This Command Executes

PXM, FRSM, AUSM-8T1E1, CESM, VISM

Syntax for PXM, FRSM, CESM, VISM

dspsarcnt <*ChanNum*>

Syntax Description

ChanNum Channel number, in the range appropriate for the card.

- PXM range = 16–1024
- FRSM
 - 8T1/E1 range = 16–1015
 - HS1/B range = 16–1015
 - T3/E3/HS2 range = 16–2015
 - 2CT3 range = 16–4015
- CESM
 - 8T1/E1 range = 32–279
 - T3/E3 = one connection starting at 32
- VISM range = 32–255

Syntax for AUSM-8T1E1

dspsarcnt <*port.VPI.VCI* | *ChanNum*>

Syntax Description

port.VPI.VCI Port range = 1–n, as appropriate for the physical installation.

VPI range = 1–4095.

VCI range = 1–65535.

ChanNum Channel number, in the range 16–1015.

Related Commands

dspsarcnts

Attributes

Log: No State: Any Privilege: Any

Examples

This section contains the following examples:

- Display SAR count on the current CESM, channel 22.
- Display SAR count on the current FRSM, channel 17.
- Display SAR count for channel 98 on the current card (an AUSM).
- Display SAR count for channel 37 on the current card (a VISM).

Example 1-307 Display SAR count on the current CESM, channel 22

```
spirit3.1.13.CESM.a > dspsarcnt 22

                               SarShelfNum:      1
                               SarSlotNum:        13
                               SarChanNum:        22
                               Tx                Rx
                               -----
Total Cells:                   11227853          11529804
Total CellsCLP:                 0                0
Total CellsAIS:                 498805           0
Total CellsFERF:                 0              302222
Total CellsEnd2EndLpBk:         0                0
Total CellsSegmentLpBk:         0                0
RcvCellsDiscOAM:                0                0

Syntax : dspsarcnt "chan_num"
        channel number-value ranging from 32 to 279

possible errors are :
a) illegal/invalid parameters
b) channel doesn't exist
spirit3.1.13.CESM.a >
```

Example 1-308 Display SAR count on the current FRSM, channel 17

```
wilco.1.1.FRSM.a > dspsarcnt 17
```

	SarShelfNum:	1	
	SarSlotNum:	1	
	SarChanNum:	17	
		Tx	Rx
		-----	-----
Total Cells:	0		0
Total CellsCLP:	0		0
Total CellsAIS:	3852		0
Total CellsFERF:	0		0
Total CellsEnd2EndLpBk:	0		0
Total CellsSegmentLpBk:	0		0
RcvCellsDiscOAM:			0

Syntax : dspsarcnt "chan_num"
channel number -- value ranging from 16 to 1015

possible errors are :
a) illegal/invalid parameters
b) channel doesn't exist

```
wilco.1.1.FRSM.a >
```

Example 1-309 Display SAR count for channel 98 on the current card (an AUSM)

```
spirit3.1.4.AUSM.a > dspsarcnt 98
```

	SarShelfNum:	1	
	SarSlotNum:	4	
	SarChanNum:	98	
		Tx	Rx
		-----	-----
Total Cells:	141357		0
Total CellsCLP:	0		0
Total CellsAIS:	0		0
Total CellsFERF:	0		0
Total CellsEnd2EndLpBk:	0		0
Total CellsSegmentLpBk:	0		0
RcvCellsDiscOAM:			0

```
spirit3.1.4.AUSM.a >
```

Example 1-310 Display SAR count for channel 37 on the current card (a VISM)

```
spirit.1.5.VISM8.a > dspsarcnt 37

                SarShelfNum:      1
                SarSlotNum:       5
                SarChanNum:       37
                Tx                  Rx
                -----
Total Cells:    667605215          2717092629
Total CellsCLP: 0                  0
Total CellsAIS: 2151235452        2150307780
Total CellsFERF: 229              33554690
Total CellsEnd2EndLpBk: 2150293128 15
Total CellsSegmentLpBk: 50331906    2151235408
RcvCellsDiscoAM: 2                  2

Syntax : dspsarcnt "chan_num"
        channel number -- values : 32 - 255

        possible errors are :
        a) illegal/invalid parameters
        b) channel doesn't exist

spirit.1.5.VISM8.a >
```

dspsarcnts

Use the **dspsarcnts** command to view current segmentation and reassembly (SAR) counter values.

Full Name

Display SAR Counters

Card(s) on Which This Command Executes

PXM, FRSM, CESH

Syntax

dspsarcnts

Related Commands

dspsarent

Attributes

Log: No

State: Any

Privilege: Any

Example 1-311 Show the current SAR counts for the FRSM

wilco.1.1.FRSM.a > dspsarcnts

```
SarShelfNum: 1
SarSlotNum: 1
SarChanNum: 0
Tx Rx
-----
Total Cells: 0 0
Total CellsCLP: 0 0
Total CellsAIS: 0 0
Total CellsFERF: 0 0
Total CellsEnd2EndLpBk: 0 0
Total CellsSegmentLpBk: 0 0
RcvCellsDiscOAM: 0 0
```

Type <CR> to continue, Q<CR> to stop:

```
SarShelfNum: 1
SarSlotNum: 1
SarChanNum: 2
Tx Rx
-----
Total Cells: 3912 9611
Total CellsCLP: 0 0
Total CellsAIS: 0 0
Total CellsFERF: 0 0
Total CellsEnd2EndLpBk: 0 0
Total CellsSegmentLpBk: 0 0
RcvCellsDiscOAM: 0 0
```

Type <CR> to continue, Q<CR> to stop:

```
SarShelfNum: 1
SarSlotNum: 1
SarChanNum: 3
Tx Rx
-----
Total Cells: 0 0
Total CellsCLP: 0 0
Total CellsAIS: 0 0
Total CellsFERF: 0 0
Total CellsEnd2EndLpBk: 0 0
Total CellsSegmentLpBk: 0 0
RcvCellsDiscOAM: 0 0
```

Type <CR> to continue, Q<CR> to stop:

```
SarShelfNum: 1
SarSlotNum: 1
SarChanNum: 15
Tx Rx
-----
Total Cells: 0 0
Total CellsCLP: 0 0
Total CellsAIS: 0 0
Total CellsFERF: 0 0
Total CellsEnd2EndLpBk: 0 0
Total CellsSegmentLpBk: 0 0
RcvCellsDiscOAM: 0 0
```

Type <CR> to continue, Q<CR> to stop:

```
SarShelfNum: 1
```

	SarSlotNum:	1	
	SarChanNum:	17	
	Tx		Rx
	-----		-----
Total Cells:	0		0
Total CellsCLP:	0		0
Total CellsAIS:	3952		0
Total CellsFERF:	0		0
Total CellsEnd2EndLpBk:	0		0
Total CellsSegmentLpBk:	0		0
RcvCellsDiscOAM:			0

dspserialif

Use the **dspserialif** command to view the speed of a serial port.

Full Name

Display Serial Interface

Card(s) on Which This Command Executes

PXM

Syntax

dspserialif -if <serial_port_num>

Syntax Description

serial_port_num Serial port number, either:

- 1 = console
- 2 = slip

Attributes

Log: No State: Active Privilege: Any

Examples

Example 1-312 Display the speed setting on a console port

```
NODENAME.1.7.PXM.a > dspserialif -if 1
SerialPortNum      : 1
SerialPortType     : debug
SerialPortEnable   : Enable
SerialPortBps      : 9600bps
```

Example 1-313 Display the speed setting on a slip port

```
NODENAME.1.7.PXM.a > dspserialif -if 2
SerialPortNum      : 2
SerialPortType     : main
SerialPortEnable   : Enable
SerialPortBps      : 9600bps
```

dspserverate

Use the **dspserverate** command to view the service rate in cells per second on the selected channel.

Full Name

Display Service Rate

Card(s) on Which This Command Executes

FRSM

Syntax

dspserverate <ChanNum>

Syntax Description

ChanNum Channel number, in the range appropriate for the interface.

- FRSM-8T1/E1 range = 16–1015
- FRSM-T3/E3/HS2 range = 16–2015
- FRSM-2CT3 range = 16–4015
- FRSM HS1/B range = 16-271

Attributes

Log: No

State: Any

Privilege: Any

Example 1-314 Display the service rate on channel 22 on the current card

```
spirit3.1.17.FRSM.a > dspserverate 22  
  
Service Rate (cells/sec):      1000  
  
spirit3.1.17.FRSM.a >
```

dspshelfalm

Use the **dspshelfalm** command to view the shelf alarms for the MGX 8800 series shelf. The status of every alarm appears in the display unless you include the optional argument and include a specific alarm number. See the example for the number for each alarm.

In the **dspshelfalm** display, the State column shows whether the alarm has been asserted. “Normal” means that no alarm has been asserted. If an alarm exists, State shows “Above Normal” or “Below Normal.” The presence of the word “missing” in the State column means that the input is missing or ignored. The content of the Severity column indicates the severity of the alarm.

Full Name

Display Shelf Alarms

Card(s) on Which This Command Executes

PXM

Syntax

dspshelfalm [-alm <*alarm number*>]

Syntax Description

-alm Command delineator that precedes the *alarm number* entry.

alarm number Alarm number to display, in the range 1–27.

Related Commands

None

Attributes

Log: No State: Active Privilege: Any

Examples

This section contains the following examples.

- Display the status of all shelf alarms
- Display the status of shelf alarm 6

Example 1-315 Display the status of all shelf alarms

```
spirit3.1.7.PXM.a > dspshelfalm
```

```
manish.1.7.PXM.a > dspshelfalm
```

Alarm	Type	Unit	Thresh	Severity	Measurable	Val	State
1	Temperature	1	50	Minor	Yes	28	Normal
2	Power Supply	1	0	Minor	No	0	Missing
3	Power Supply	2	0	Minor	No	0	Missing
4	Power Supply	3	0	Minor	No	0	Normal
5	Power Supply	4	0	Minor	No	0	Missing
6	Power Supply	5	0	Minor	No	0	Missing
7	Power Supply	6	0	Minor	No	0	Missing
8	DC Level	1	6	Minor	Yes	0	Below normal
9	DC Level	2	6	Minor	Yes	49	Normal
10	Fan Unit	1	2000	Minor	Yes	0	Missing
11	Fan Unit	2	2000	Minor	Yes	0	Missing
12	Fan Unit	3	2000	Minor	Yes	0	Missing
13	Fan Unit	4	2000	Minor	Yes	0	Missing
14	Fan Unit	5	2000	Minor	Yes	0	Missing
15	Fan Unit	6	2000	Minor	Yes	0	Missing
16	Fan Unit	7	2000	Minor	Yes	0	Missing
17	Fan Unit	8	2000	Minor	Yes	0	Missing
18	Fan Unit	9	2000	Minor	Yes	0	Missing
19	Fan Unit	10	2000	Minor	Yes	3582	Normal
20	Fan Unit	11	2000	Minor	Yes	3588	Normal

```
Type <CR> to continue, Q<CR> to stop:
```

Alarm	Type	Unit	Thresh	Severity	Measurable	Val	State
21	Fan Unit	12	2000	Minor	Yes	3666	Normal
22	Fan Unit	13	2000	Minor	Yes	3630	Normal
23	Fan Unit	14	2000	Minor	Yes	3528	Normal
24	Fan Unit	15	2000	Minor	Yes	3534	Normal
25	Fan Unit	16	2000	Minor	Yes	3498	Normal
26	Fan Unit	17	2000	Minor	Yes	3468	Normal
27	Fan Unit	18	2000	Minor	Yes	3420	Normal

```
ASMNumOfValidEntries: 27
```

```
ASMSshelfAlarmState: 2
```

```
manish.1.7.PXM.a >
```

Example 1-316 Display the status of shelf alarm 6

```
spirit3.1.7.PXM.a > dspshelfalm -alm 6
```

Alarm	Type	Unit	Thresh	Severity	Measurable	Val	State
6	Power Supply	4	?	Minor	No	0	Normal

```
ASMNumOfValidEntries: 27
```

```
ASMSshelfAlarmState: 2
```

```
spirit.1.7.PXM.a >
```

dspslftst

Use the **dspslftst** command to view the self-test routine on the current card.

Full Name

Display Self-Test

Card(s) on Which This Command Executes

FRSM, AUSM, CESM

Syntax

dspslftst

Related Commands

clrslftst, cnfslftst, runslftstno

Attributes

Log: No

State: Any

Privilege: Any

Example 1-317 Display the self-test results for the switch

```
wilco.1.1.FRSM.a > dspslftst

SelfTestEnable:      Enabled
SelfTestPeriod:      5
SelfTestState:       SelfTest Passed
SelfTestResultDescription: No failure information available

wilco.1.1.FRSM.a >
```

dpslftsttbl

Use the **dpslftsttbl** command to view the current contents of the self-test table.

Full Name

Display Self-Test Table

Card(s) on Which This Command Executes

FRSM

Syntax

dpslftsttbl

Related Commands

dpslftst

Attributes

Log: No State: Any Privilege: 1–6

Example 1-318 Show current statistics for self-test table on the FRSM

```
wilco.1.3.VHS2CT3.a > dpslftsttbl
```

Test #	Test Name	Thold	Fail	Pass	Last	Enab	Destr	Card	Rst
1	CPU DRAM access test	1	0	0	P	Y	N	Y	
2	SAR self test	1	0	0	P	Y	N	Y	
3	ISE self test	1	0	0	P	Y	N	Y	
4	ESE self test	1	0	0	P	Y	N	Y	
5	CODE checksum test	1	0	0	P	Y	N	Y	
6	Line loopback test	1	0	0	P	Y	Y	Y	
7	FREEDM test	1	0	0	P	Y	Y	Y	
8	Data loopback test	1	0	0	P	Y	Y	Y	
9	CellBus test	1	0	0	P	Y	N	N	

```
wilco.1.3.VHS2CT3.a >
```

dspslotlink

Use the **dspslotlink** command to view SRM-3T3 link information for all the lines on the specified service module slot.

Full Name

Display Slot Link

Card(s) on Which This Command Executes

PXM

Syntax

dspslotlink <slot number>

Syntax Description

slot number Slot number of the card from which to view the SRM-3T3 link information.

Related Commands

delslotlink

Attributes

Log: No State: Active Privilege: 1

Example 1-319 Display the SRM-3T3 link information for slot 1

```
spirit3.1.7.PXM.a > dspslotlink 1

Slot Num      : 1
Max Lines     : 0
Link Counter  : 0

Slot  Line#  T3 Line#  T1 Slot#
====  =====  ===========  ===========
  1     1       0         0
  1     2       0         0
  1     3       0         0
  1     4       0         0
  1     5       0         0
  1     6       0         0
  1     7       0         0
  1     8       0         0

spirit3.1.7.PXM.a >
```

dspsmcnf

Use the **dspsmcnf** command to view summaries of the configurations for service modules in the system.

Full Name

Display Service Module Configuration

Card(s) on Which This Command Executes

PXM

Syntax

dspsmcnf

Related Commands

clrsmcnf

Attributes

Log: Yes

State: Active

Privilege: Any

Example 1-320 Display the configuration of all the service modules in the switch

MGX 88003.1.3.PXM.a > dspsmcnf

slot No.	Card Type	Rate Control	Channel ized	IMA	MULTRKS	MIB Version	Feature Bits
1	----->	No configuration file exist for this slot				<-----	
2	----->	No configuration file exist for this slot				<-----	
3	FRSM-8T1	On	On	Off	Off	20	0x3
4	FRSM-8T1	On	On	Off	Off	20	0x3
5	----->	No configuration file exist for this slot				<-----	
6	----->	No configuration file exist for this slot				<-----	
9	----->	No configuration file exist for this slot				<-----	
10	----->	No configuration file exist for this slot				<-----	
11	----->	No configuration file exist for this slot				<-----	
12	----->	No configuration file exist for this slot				<-----	
13	----->	No configuration file exist for this slot				<-----	
14	----->	No configuration file exist for this slot				<-----	
17	----->	No configuration file exist for this slot				<-----	
18	----->	No configuration file exist for this slot				<-----	
19	----->	No configuration file exist for this slot				<-----	
20	FRSM-8E1	Off	Off	Off	Off	20	0x0
21	----->	No configuration file exist for this slot				<-----	
22	----->	No configuration file exist for this slot				<-----	
25	----->	No configuration file exist for this slot				<-----	
26	----->	No configuration file exist for this slot				<-----	
27	----->	No configuration file exist for this slot				<-----	
28	----->	No configuration file exist for this slot				<-----	
29	----->	No configuration file exist for this slot				<-----	
30	----->	No configuration file exist for this slot				<-----	

dspsnmp

Use the **dspsnmp** command to view the community string configured on a service module.

Full Name

Display SNMP

Card(s) on Which This Command Executes

PXM

Syntax

dspsnmp

Related Commands

cnfsnmp

Attributes

Log: No

State: Active

Privilege: SuperUser

Example 1-321 Display the SNMP community string

```
popeye.1.7.PXM.a > dspsnmp
```

```
Community String      :POPEYE
```

dspsrmclksrc

Use the **dspsrmclksrc** command to view the SRM-3T3 clock source for a specified T3 line.

Full Name

Display SRM Clock Source

Card(s) on Which This Command Executes

PXM, SRM-3T3

Syntax

dspsrmclksrc -ds3 <*T3 line number*>

Syntax Description

-ds3 Command delineator for the *T3 line number* entry.

T3 line number T3 line number is in the format *slot.line*.

- Slot = enter a value from the range 7, 8, 15, 16, 31, 32
- Line range = 1–3

Related Commands

cnfsrcmclksrc

Attributes

Log: No State: Active Privilege: 1

Example 1-322 Display the clock source for T3 line 1 on the SRM-3T3 in slot 15

```
spirit.1.7.PXM.a > dspsrmclksrc -ds3 15.1

  LineNum:          1
  LineXmtClockSource:  backplane clock from BNM

spirit.1.7.PXM.a >
```

dspstatparms

Use the **dspstatparms** command to view statistics parameters on the current card.

Full Name

Display Statistics Parameters

Card(s) on Which This Command Executes

PXM, AUSM, CESH, FRSM

Syntax

dspstatparms

Attributes

Log: No State: Active Privilege: 1

Example 1-323 Display statistics parameter settings on the current card (FRSM-2CT3)

```
wilco.1.3.VHS2CT3.a > dspstatparms

TFTP Retry Count:                1
TFTP ACK time-out (sec):         60
Bucket Interval:                 0
File Interval:                   0
Peak Enable Flag:                Disabled
Object Count:                    0           STATS COLLECTION: Disabled
Object Subtype Counts:           0 0 0 0
Total File Memory Used:          0
Number of File Allocated:        0
Current File Size:               0
Stat Memory Allocated:           0
Auto Memory Allocated:           0
Auto Mem Rgn Size:               6291456

wilco.1.3.VHS2CT3.a >
```

dspswfunc

Use the **dspswfunc** PAR command to view status of certain node-level, paid features on the node. The features are the feeder implementation (or default routing implementation) of the switch and virtual source/virtual destination (VSVD) control for ABR traffic.

Full Name

Display Software Function

Card(s) on Which This Command Executes

PXM

Syntax

dspswfunc

Related Commands

cnfswfunc

Attributes

Log: Yes State: Active Privilege: SuperUser

Example 1-324 Display whether or not paid features (feeder implementation or default routing implementation) of the switch and VSVD control for ABR traffic) have been enabled

```
spirit.1.8.PXM.a > dspswfunc

  1.  ABR VSVD(enable(yes)/disable(no):    NO
  2.  Node Type(routing(routing)/Feeder(fdr):  ROUTING

spirit.1.8.PXM.a >
```

dspsysparm

Use the **dspsysparm** command to view system parameters.

Full Name

Display System Parameters

Card(s) on Which This Command Executes

PXM

Syntax

dspsysparm

Related Commands

cnfsysparm

Attributes

Log: No State: Any Privilege: Any

Example 1-325 Display the system parameters for the node

```
spirit.1.8.PXM.a > dspsysparm
  Max Time Stamped Packet Age(msec)                32
  Fail Connections On Communication Break           YES
  Interval Statistics polling rate for VCs           5
  Max Network Delay for 'v' connections(msec)       112
  Max Network Delay for 'c' connections(msec)       112
  Max Network Delay for 't' & 'p' connections(msec) 112
  Max Network Delay for 'a' connections(msec)       216
  Max Network Delay for High Speed Data connections(msec) 256
  Max Network Delay for CDP-CDP 'v' connections(msec) 512
  Max Network Delay for CDP-CDP 'c' connections(msec) 512
  Max Network Delay for CDP-CDP 't' & 'p' connections(msec) 512
  Max Network Delay for CDP-CDP 'a' connections(msec) 512
  Max Network Delay for CDP-CDP High Speed Data connections(msec) 512
  Max Local Delay for Interdom CDP-CDP 'v' conns (msec) 216
  Max Local Delay for Interdom CDP-CDP 'c' conns (msec) 216
  Max Local Delay for Interdom CDP-CDP 't' & 'p' conns(msec) 216
  Max Local Delay for Interdom CDP-CDP 'a' conns(msec) 216
  Max Local Delay for Interdom CDP-CDP High Speed Data conns(msec) 216
  Max Local Delay for Interdom High Speed Data conns (msec) 216
  FastPAD Jitter Buffer Size (msec)                 3
  Enable Discard Eligibility                        0
  Use Frame Relay Standard Parameters Bc and Be    0
  Enable Connection Deroute Delay feature          0
  Number of Consecutive Invalid Login Attempts to Cause Major Alarm 0

spirit.1.8.PXM.a >
```

dsptotals

Use the **dsptotals** command to view line, port, and channel totals for the current card.

Full Name

Display Totals

Card(s) on Which This Command Executes

FRSM

Syntax

dsptotals

Related Commands

None

Attributes

Log: No State: Any Privilege: 1–6

Example 1-326 Show total active lines, ports, and channels on the current card

```
spirit.1.13.VHS2CT3.a > dsptotals

total active lines = 0/56
total active ports = 0/256
total active chans = 0/1000

spirit.1.13.VHS2CT3.a >
```

dsptrafficgen

Use the **dsptrafficgen** command to display the status of a traffic generation test. This traffic generation test is used to determine and troubleshoot cell loss and is intended for defective PVCs.

Software Version

Command available with 1.1.20 and higher.

Full Name

Display Traffic Generation Test

Card(s) on Which This Command Executes

FRSM-VHS (2CT3/2T3/2E3/HS2)

Syntax

dsptrafficgen

Related Commands

cnftrafficgen

Attributes

Log: No State: Any Privilege: Any

Example 1-327 Display the traffic generation test on connection 16

```
spirit.1.1.VHS2CT3.a > dsptrafficgen

Pvc Under Test : 16
Pattern type   : 1( All 0's )
Total Test Frames To Send      : 100
Total Test Frames Transmitted : 100
Total Test Frames Received    : 0
```

dspttrapip

Use the **dspttrapip** command to view the IP address of the interface associated with outgoing traps. The identity of this interface is derived from your settings using the **cnftrapip** command.

Full Name

Display Outgoing Trap IP Address

Card(s) on Which This Command Executes

PXM

Syntax

dspttrapip

Related Commands

cnftrapip, addtrapmgr, deltrapmgr, xdspttrapmgr

Attributes

Log: No State: Active Privilege: Any

Example 1-328 Display the IP address that will be placed in outgoing traps

```
spirit.1.8.PXM.a > dspttrapip  
  
Trap IP Address :172.29.22.214  
  
spirit.1.8.PXM.a >
```

dsptrapmgr

Use the **dsptrapmgr** command to view a list of all the SNMP Managers that are registered to receive traps. This display also presents the current aging parameter set for the traps, as defined by using the **agetrapmgr** command.

Full Name

Display Trap Managers

Card(s) on Which This Command Executes

PXM

Syntax

dsptrapmgr

Related Commands

agetrapmgr

Attributes

Log: No State: Any Privilege: Any

Example 1-329 Display the configuration of all the SNMP Managers that are registered to receive traps on the switch

```
wilco.1.7.PXM.a> dsptrapmgr
ipAddress      PortNum  RowStatus  ReadTrapFlag  NextTrapSeqNum  Aging
-----
171.71.0.54    69       Add        Off            0                ENABLE
171.71.54.65   162      Add        Off            0                ENABLE
171.71.54.69   162      Add        Off            0                ENABLE
172.29.37.75   2500     Add        Off            100023           ENABLE
172.29.37.209  2500     Add        Off            100150           ENABLE
```

```
LastTrapSeqNum: 100150
NumOfValidEntries: 5
```

All the trap managers have aging enabled (default).

```
wilco.1.7.PXM.a>
```

dsptrkcnf

Use the **dsptrkcnf** PAR command to view the configuration for a trunk.

Full Name

Display Trunk Configuration

Card(s) on Which This Command Executes

PXM

Syntax

dsptrkcnf <slot,port>

Syntax Description

- slot.port* Slot and port number.
- Slot = enter the value 7, or 15, or 31
 - Port range = 1–*n*, as appropriate for the physical installation

Related Commands

addtrk, dsptrks, cnftrk, dsptrkload

Attributes

Log: No State: Any Privilege: Any

Example 1-330 Display the configuration on trunk 1 on the card in slot 7

```
spirit3.1.8.PXM.a > dsptrkcnf 7.1

      TRUNK   CONFIGURATION
-----
Statistical Reserve      : 1000
CC Restriction           : NO
Line Type                 :
Pass Sync                 : TRUE
Deroute Delay            : 0
Traffic Classes          : FST FR NTS TS VOICE CBR VBR ABR
Routing Cost             : 10
Vcc Conids               : 0
Vpc Conids               : 0

spirit3.1.8.PXM.a >
```

dsptrkload

Use the **dsptrkload** PAR command to view load information for a trunk. This command applies to only the routing node implementation.

Full Name

Display Trunk Load

Card(s) on Which This Command Executes

PXM

Syntax

dsptrkload <*slot.port*>

Syntax Description

slot.port Slot and port number.

- Slot = enter the value 7, or 15, or 31
- Port range = 1–*n*, as appropriate for the physical installation

Related Commands

addtrk, dsptrks, cnftrk, dsptrknf

Attributes

Log: No State: Any Privilege: Any

dsptrks

Use the **dsptrks** PAR command to view all trunks on the node. This command applies to only the routing node implementation.

Full Name

Display Trunks

Card(s) on Which This Command Executes

PXM

Syntax

dsptrks

Related Commands

addtrk, cnftrk, dsptrknf, dsptrkload

Attributes

Log: No

State: Any

Privilege: Any

dspunit391

Use the **dspunit391** command to view the current setting for UNI T391 on a specified FRSM card.

Full Name

Display UNI T391

Card(s) on Which This Command Executes

FRSM

Syntax

dspunit391

Related Commands

addrk, cnftrk, dsptrknf, dsptrkload

Attributes

Log: No

State: Any

Privilege: Any

Example 1-331 Display the current setting for T391

```
spirit.1.1.FRSM.a > dspunit391
```

```
System UNI T391 = 5 seconds
```

```
spirit.1.1.FRSM.a >
```

dspupgrade

Use the **dspupgrade** command to view the current upgrade status of the active and the standby PXM.

Full Name

Display Upgrade State

Card(s) on Which This Command Executes

PXM

Syntax

dspupgrade

Related Commands

rstupgrade, newrev, install, abort, commit, dspfwrevs, printrev

Attributes

Log: No

State: Any

Privilege: Any

Example 1-332 Display the upgrade state for the two PXMs

```
spirit4.1.8.PXM.a > dspupgrade
```

```
active: 'upgrade idle'
```

```
standby: 'upgrade idle'
```

```
spirit4.1.8.PXM.a >
```

dspusers

Use the **dspusers** command to view the user IDs that have been added to the PXM configuration. The screen shows the user name and highest privilege level and displays the number of those levels above user-privilege.

Full Name

Display Users

Card(s) on Which This Command Executes

PXM

Syntax

dspusers

Related Commands

adduser, deluser

Attributes

Log: No

State: Any

Privilege: Any

Example 1-333 Display the users configured for this shelf. The users in this example are Raoul and Duke.

```
wilco.1.7.PXM.a > dspusers
```

```
UserId      AccessLevel
-----
cisco       CISCO_GP
service     SERVICE_GP
superuser   SUPER_GP
raoul       GROUP3
duke        GROUP1
```

```
wilco.1.7.PXM.a >
```

dspver

Use the **dspver** command to view firmware versions currently running in both PXM cards.

Full Name

Display Firmware Version

Card(s) on Which This Command Executes

PXM

Syntax

dspver [*bt*]

Syntax Description

[*bt*] Backup boot.

Related Commands

None

Attributes

Log: No State: Any Privilege: Any

Example 1-334 Display the version of firmware running in both PXM cards

```
raviraj.1.1.7.PXM.a > dspver
PXM FW versions:

active: 1.1.10
standby: 1.1.10
```

dspvismip

Use the **dspvismip** command to view the IP configuration information for the VISM card. This command displays the results of **cnfvismip** configurations.

Full Name

Display VISM IP Parameters

Card(s) on Which This Command Executes

VISM

Syntax

dspvismip

Related Commands

cnfvismip

Attributes

Log: No

State: Active

Privilege: Any

Example 1-335 Display the IP configuration information for the current VISM card

```
spirit.1.5.VISM8.a > dspvismip

VismIpAddress:      198.45.26.101
NetMask:            255.255.255.0

spirit.1.5.VISM8.a >
```

dth

Use the **dth** command to view transaction trace handler statistics.

Full Name

Display Transaction Trace Handler

Card(s) on Which This Command Executes

PXM

Syntax

dth

Related Commands

cth, thtrace

Attributes

Log: No State: Active Privilege: Any

Example 1-336 Display Transaction Trace Handler Detail

```
spirit.1.5.VISM8.a > dth  
  
Trace Buffer is empty  
  
spirit.1.5.VISM8.a >
```

dvs

Use the **dvs** command to view the VIS trace buffer.

Full Name

Display VSI

Card(s) on Which This Command Executes

PXM

Syntax

dvs

Related Commands

cvsi, vsistats, vsitrace

Attributes

Log: No

State: Any

Privilege: Cisco Group

Example

```
porky.1.7.PXM.a > dvs  
VSI Trace Buffer is empty
```

```
porky.1.7.PXM.a >
```

exit

Use the **exit** command to exit the current CLI shell.

Full Name

Exit from CLI

Card(s) on Which This Command Executes

PXM, FRSM, AUSM, CISM, VISM

Syntax

exit

Related Commands

bye, logout

Attributes

Log: Yes

State: Any

Privilege: Any

Example 1-337 Exit from the current CLI shell

```
spirit4.1.8.PXM.a > exit
```

```
(session ended)
```

formatdisk

Use the **formatdisk** command to format the disk and removes all disk contents. There is a warning prompt before this command is executed, at which point you can cancel the command. If you acknowledge the prompt, the command executes, taking about 30 minutes to format a 2 GB disk.

Full Name

Format Disk

Card(s) on Which This Command Executes

PXM

Syntax

formatdisk

Related Commands

syncdisk

Attributes

Log: No

State: Any

Privilege: Super Group

help

Use the **help** command to view commands associated with the current card. The **help** command is case-sensitive.

This command takes no arguments and therefore does not provide information about specific commands.

Full Name

Help

Card(s) on Which This Command Executes

PXM, FRSM, AUSM, CESM, VISM

Syntax

help

Related Commands

None

Attributes

Log: No State: Any Privilege: Any

Examples

This section contains the following examples:

- Display current PXM card command suite.
- Display current AUSM card command suite.
- Display current FRSM card command suite.
- Display current VISM card command suite.
- Display current CESM card command suite.

Example 1-338 Display current PXM card command suite

```
popeye3.1.8.PXM.a > help
Available commands
-----
?
abort
addapsln
addcdrsoprtn
addchan
addcon
addlink
addlmiloop
addln
addlnloop
addport
addred
addrscprtn
addserialif
addtrapmgr
adduser
agetrapmgr
arpAdd
arpDelete
Type <CR> to continue, Q<CR> to stop:
```

```
Available commands
-----
arpFlush
arpShow
bootChange
bye
cc
cd
checkStack
clidbxlevel
cliPlugin
cliPlugout
clmi
clrallcnf
clralm
clralmct
clratmlnct
clratmlnctns
clrchanct
clrchanctns
clrconct
Type <CR> to continue, Q<CR> to stop:
```

```
Available commands
-----
clrconctns
clrerr
clrifct
clrifctns
clrlmistats
clrlog
clrportct
clrportctns
clrscrn
clrsmcnf
clrsrmcnf
cmdhistory
cnfapsln
cnfatmln
```

```
cnfbert
cnfcdprtntype
cnfcdrsoprtn
cnfchan
cnfchanq
Type <CR> to continue, Q<CR> to stop:
```

```
Available commands
-----
cnfclksrc
cnfcon
cnfdate
cnfextclk
cnfif
cnfifastrk
cnfifip
cnfilmi
cnfln
cnfname
cnfpasswd
cnfport
cnfportrsoprtn
cnfprfparam
cnfrsoprtn
cnfserialif
cnfsrcmlksrc
cnfstatsmgr
cnfswfunc
```

Type <CR> to continue, Q<CR> to stop:

```
Available commands
-----
cnftime
cnftmzn
cnftmzngmt
cnftrapip
cnftrk
cnfupcabr
cnfupccbr
cnfupcubr
cnfupcvbr
commit
copy
cp
cth
cvsi
dbxclierrcode
dcct
dcondb
del
delapsln
```

Type <CR> to continue, Q<CR> to stop:

```
Available commands
-----
delbert
delcdrsoprtn
delchan
delcon
delelete
delifip
dellink
dellmiloop
delln
dellnloop
```

```
delport
delred
delrscprtn
delserialif
delslotlink
deltrapmgr
deltree
deluser
dir
```

Type <CR> to continue, Q<CR> to stop:

Available commands

```
-----
dlmi
dnibname
dnibnum
dnif
dnilmi
downloadflash
dspalm
dspalmcnf
dspalmcnt
dspalms
dspapsCfg
dspapsln
dspatmlncnf
dspatmlncnt
dspbert
dspcd
dspcderrs
dspcdprntype
dspcdrschrtn
```

Type <CR> to continue, Q<CR> to stop:

Available commands

```
-----
dspcds
dspchan
dspchancnt
dspchans
dspclkinfo
dspclksrc
dspcon
dspconcnt
dspcons
dspcurclk
dsperr
dspfw
dspfwrevs
dspif
dspifcnt
dspifip
dspifrsc
dspifs
dspilmi
```

Type <CR> to continue, Q<CR> to stop:

Available commands

```
-----
dspilmicnt
dspilmis
dsplink
dsplmiloop
dsplmistats
dspln
```

dsplnrsc
dsplns
dsplog
dsplogs
dspname
dspnwip
dsponoff
dspparifs
dspportcnt
dspportrscrptn
dspports
dspprf
dspprfhist

Type <CR> to continue, Q<CR> to stop:

Available commands

dspred
dsprscrptn
dsprscrptns
dpsarchans
dpsarcnt
dpsarcnts
dspserialif
dspshelfalm
dspslotlink
dpsmcnf
dpsrmclksrc
dspstatparms
dpswfunc
dsptrapip
dsptrapmgr
dsptrkcnf
dsptrkload
dsptrks
dspupgrade

Type <CR> to continue, Q<CR> to stop:

Available commands

dspusers
dspver
dth
dumpaps
dumptrace
dvs
exit
formatdisk
Help
history
ifShow
install
lkAddr
lkup
ll
lmitrace
logout
ls
memShow

Type <CR> to continue, Q<CR> to stop:

Available commands

mkdir
mkfs

```
modbert
mv
myid
newrev
onoff
pagemode
passwd
ping
printlog
printrev
pwd
remove
rename
resetcd
resetsys
restoreallcnf
rm
```

Type <CR> to continue, Q<CR> to stop:

```
Available commands
```

```
-----
```

```
rmdir
routeAdd
routeDelete
routeNetAdd
routeShow
routestatShow
rstupgrade
saveallcnf
sesntimeout
sesnwatchdog
shellConn
showsyserr
shutdisk
smclrscrn
softswitch
stackdump
stacktrace
switchapsln
```

Type <CR> to continue, Q<CR> to stop:

```
Available commands
```

```
-----
```

```
switchback
switchcc
syncdisk
syserr
taskRegsShow
taskShow
thtrace
timeout
tmOff
tmOn
tstcon
tstconseg
tstdelay
uncnfifastrk
upif
upilmi
users
version
vsistats
```

Type <CR> to continue, Q<CR> to stop:

```
Available commands
```

```
-----
```

vsitrace
vxcd
vxcopy
vxd
vxi
vxll
vxls
vxm
vxpwd
vxreboot
vxrename
vxrm
vxsp
vxsysToMonitor
vxt
vxti
vxtr
vxts
vxtt

Type <CR> to continue, Q<CR> to stop:

Available commands

who
whoami
xclratmlncnt
xclrchancnt
xclrifcnt
xcnfatmln
xcnfbert
xcnfcdrprtntype
xcnfcdrscprtn
xcnfchan
xcnfif
xcnfifip
xcnfilmi
xcnfred
xcnfrscprtn
xcnfshelf
xcnfsrmlink
xcnftrapmgr
xcnfupcchan

Type <CR> to continue, Q<CR> to stop:

Available commands

xcnfuser
xdspatmlncnf
xdspatmlncnt
xdspcdprtntype
xdspcdrscprtn
xdspcds
xdspchancnt
xdspchans
xdspifcnt
xdspifs
xdspilmi
xdspilmicnt
xdspport
xdspred
xdsprscprtns
xdspshelf
xdspsrmlink
xdsptrapmgr

xdspusers

popeye3.1.8.PXM.a >Display AUSM card command suite
 popeye3.1.6.AUSM8.a > **help**

Command	Logging	State	Priority
?	No	Any	Any User
Help	No	Any	Any User
addaimgrp	Yes	Active	Group 1
addchan	Yes	Active	Group 2
addchanloop	No	Active	Group 4
addcon	Yes	Active	Group 2
addimagrp	Yes	Active	Group 1
addln	Yes	Active	Group 1
addlnloop	Yes	Active	Service Group (-1)
addlns2aimgrp	Yes	Active	Group 1
addlns2imagrp	Yes	Active	Group 1
addport	Yes	Active	Group 1
addrscrptn	Yes	Active	Group 1
aimhelp	No	Any	Any User
chkflash	No	Any	Strata Group (-2)
clear	No	Any	Any User
clairaimgrp	No	Active	Group 1
clairaimlncnt	No	Active	Group 1
clairalm	No	Any	Group 5
clairalmcnt	No	Any	Group 5
clairalmcnts	No	Any	Group 5
clairalms	No	Any	Group 5
clrcderrs	No	Any	Super Group (0)
clrchan	No	Any	Group 5
clrchan	No	Any	Group 5
clrchan	No	Any	Group 3
clrchan	No	Any	Group 3
clrimaimgrp	No	Active	Group 1
clrimaimlncnt	No	Active	Group 1
clrimatst	No	Any	Group 1
clrmsgcnt	No	Any	Group 5
clrport	No	Any	Group 5
clrport	No	Any	Group 5
clrport	No	Any	Group 5
clrsar	No	Any	Group 5
clrsar	No	Any	Group 5
clrsar	No	Any	Group 5
clrscrn	No	Any	Any User
clrslftst	No	Any	Any User
clrtaskinfo	No	Any	Service Group (-1)
cls	No	Any	Any User
cnfaimgrp	Yes	Active	Group 1
cnfcdprtntype	Yes	Active	Group 2
cnfcdrs	Yes	Active	Group 1
cnfchan	Yes	Active	Group 2
cnfchanfst	Yes	Active	Group 2
cnfchanq	Yes	Active	Group 2
cnfcon	Yes	Active	Group 2
cnffst	Yes	Active	Super Group (0)
cnfilmi	Yes	Active	Group 1
cnfimaalmparm	No	Any	Group 1
cnfimagrp	Yes	Active	Group 1
cnfimatst	No	Active	Group 1
cnfln	Yes	Active	Group 1
cnflnloop	Yes	Active	Service Group (-1)
cnfplpp	Yes	Active	Group 1
cnfportq	Yes	Active	Strata Group (-2)
cnfportrs	Yes	Active	Group 1
cnfrscrptn	Yes	Active	Group 1
cnfslftst	Yes	Active	Any User
cnfsvcrange	Yes	Active	Group 1
cnfupcabr	Yes	Active	Group 2

cnfupccbr	Yes	Active	Group 2
cnfupcubr	Yes	Active	Group 2
cnfupcvbr	Yes	Active	Group 2
copychans	Yes	Active	Group 1
delaimgrp	Yes	Active	Group 1
delcdrsoprtn	Yes	Active	Group 1
delchan	Yes	Active	Group 2
delchanloop	No	Active	Group 4
delchans	Yes	Active	Group 1
delcon	Yes	Active	Group 2
delimagrp	Yes	Active	Group 1
delln	Yes	Active	Group 1
dellnloop	Yes	Active	Service Group (-1)
dellnsfmaingrp	Yes	Active	Group 1
dellnsfmimagr	Yes	Active	Group 1
delpport	Yes	Active	Group 1
delsoprtn	Yes	Active	Group 1
dnport	Yes	Active	Group 1
dspaimgrp	No	Active	Group 1
dspaimgrpcnt	No	Active	Group 1
dspaimgrps	No	Active	Group 1
dspaimlncnt	No	Active	Group 1
dspalm	No	Any	Any User
dspalmcnf	No	Any	Any User
dspalmcnt	No	Any	Any User
dspalms	No	Any	Any User
dspcd	No	Any	Any User
dspcderrs	No	Any	Any User
dspcdprtntype	Yes	Active	Group 2
dspcdrsoprtn	Yes	Active	Group 1
dspchan	No	Any	Any User
dspchanent	No	Any	Any User
dspchans	No	Any	Any User
dspcon	No	Any	Any User
dspcons	No	Any	Any User
dspfeature	No	Any	Strata Group (-2)
dspfst	No	Any	Strata Group (-2)
dspilmi	No	Any	Any User
dspilmicnt	No	Any	Any User
dspimaalmparm	No	Any	Group 1
dspimagr	No	Active	Group 1
dspimagrpcnt	No	Active	Group 1
dspimagrps	No	Active	Group 1
dspimainfo	No	Active	Any User
dspimaln	No	Any	Group 1
dspimalncnt	No	Active	Group 1
dspimatst	No	Any	Group 1
dsplcn	No	Any	Any User
dspln	No	Any	Any User
dsplns	No	Any	Any User
dsploads	No	Active	Any User
dspmsgcnt	No	Any	Any User
dspplpp	Yes	Active	Group 1
dspport	No	Any	Any User
dspportent	No	Any	Any User
dspportq	No	Any	Any User
dspportqs	No	Any	Any User
dspportrsoprtn	Yes	Active	Group 1
dspports	No	Any	Any User
dsprsoprtn	Yes	Active	Group 1
dspсарnt	No	Any	Any User
dspсарnts	No	Any	Any User
dspslftst	No	Any	Any User
dspslftsttbl	No	Any	Any User

dspstatparms	No	Any	Any User
dspsvcrange	Yes	Any	Any User
dsptaskinfo	No	Any	Service Group (-1)
dsptotals	No	Any	Any User
i	No	Any	Service Group (-1)
memShow	No	Any	Any User
myid	No	Any	Any User
oldcnfcdrcsprtn	Yes	Active	Group 1
runslftstno	No	Any	Any User
setcmdc	No	Any	Any User
setpagemode	No	Any	Any User
shellConn	Yes	Any	Strata Group (-2)
tstcon	No	Active	Group 4
tstconseg	No	Active	Group 4
tstconsti	No	Active	Group 4
tstdelay	No	Active	Group 4
tstdelaysti	No	Active	Group 4
upport	Yes	Active	Group 1
version	No	Any	Any User
xaddcon	Yes	Active	Group 1
xclrchancnt	No	Any	Group 3
xclrportcnt	No	Any	Group 3
xcnfalm	Yes	Active	Service Group (-1)
xcnfalment	Yes	Active	Group 3
xcnfcon	Yes	Active	Group 1
xcnfilmi	Yes	Active	Group 1
xcnfln	Yes	Active	Service Group (-1)
xcnfportq	Yes	Active	Group 1
xdelcon	Yes	Active	Group 1
xdnport	Yes	Active	Group 1
xdspcon	No	Any	Any User
xdspcons	No	Any	Any User
xdspilmi	No	Any	Any User
xdspln	No	Any	Any User
xdsplns	No	Any	Any User
xdspport	No	Any	Any User
xdspportq	No	Any	Any User
xdspportqs	No	Any	Any User
xdspports	No	Any	Any User
xupport	Yes	Active	Group 1

popeye3.1.6.AUSM8.a >

Example 1-339 Display FRSM card command suite

```

popeye3.1.3.FRSM.a > help
Command          Logging   State   Priority
-----
?                No       Any    Any User
Help            No       Any    Any User
addcdrsoprtn    Yes      Active Group 1
addchan         Yes      Active Group 2
addchanloop     No       Active Group 4
addcon          Yes      Active Group 2
addln           Yes      Active Group 1
addlnloop       Yes      Active Service Group (-1)
addport         Yes      Active Group 1
addrscprtn     Yes      Active Group 1
chkflash        No       Any    Strata Group (-2)
clear           No       Any    Any User
clrportcnt      No       Any    Group 5
clrportcnts     No       Any    Group 5
clrsarcnt       No       Any    Group 5
clrsarcnts      No       Any    Group 5
clrscrn         No       Any    Any User
clrslftst       No       Any    Any User
clrtaskinfo     No       Any    Service Group (-1)
cls             No       Any    Any User
cnfcdprtntype  Yes      Active Group 1
cnfcdrsoprtn    Yes      Active Group 1
cnfchancacoff   Yes      Active Group 2
cnfchanegressq Yes      Active Group 2
cnfchanfst      Yes      Active Group 2
cnfchaningressq Yes     Active Group 2
cnfchanmap      Yes      Active Group 2
cnfchanpol      Yes      Active Group 2
cnfcon          Yes      Active Group 2
cnffst          Yes      Active Super Group (0)
cnfln           Yes      Active Group 1
cnflnloop       Yes      Active Service Group (-1)
cnfoamlpbk      No       Any    Any User
cnfport         Yes      Active Group 1
cnfportc1lm     Yes      Active Group 1
cnfportrscprtn Yes      Active Group 1
cnfrscprtn      Yes      Active Group 1
cnfslftst       Yes      Any    Any User
cnftrafficgen   No       Any    Any User
cnfunit391      No       Active Super Group (0)
copychans       Yes      Active Group 1
copyports       Yes      Active Group 1
delcdrsoprtn    Yes      Active Group 1
delchan         Yes      Active Group 2
delchanloop     No       Active Group 4
delchans        Yes      Active Group 1
delcon          Yes      Active Group 2
delln           Yes      Active Group 1
dellnloop       Yes      Active Service Group (-1)
delport         Yes      Active Group 1
delports        Yes      Active Group 1
downport        Yes      Active Group 2
dspalm          No       Any    Any User
dspalmcnf       No       Any    Any User
dspalmcnt       No       Any    Any User
dspalms         No       Any    Any User
dspbufoverflow  No       Any    Super Group (0)
dspcd           No       Any    Any User
dspcderrs       No       Any    Any User
dspcdprtntype  No       Any    Any User

```

dspcdrscrprtn	No	Any	Any User
dspchan	No	Any	Any User
dspchancnt	No	Any	Any User
dspchanmap	No	Any	Any User
dspchans	No	Any	Any User
dspchstats	No	Any	Any User
dspcon	No	Any	Any User
dspcons	No	Any	Any User
dspfeature	No	Any	Strata Group (-2)
dspfst	Yes	Active	Group 4
dsplcn	No	Active	Any User
dspln	No	Any	Any User
dsplns	No	Any	Any User
dspmptbl	No	Any	Any User
dspmsgcnt	No	Any	Any User
dspoampbk	No	Any	Any User
dspport	No	Any	Any User
dspportcnt	No	Any	Any User
dspportscrprtn	No	Any	Any User
dspports	No	Any	Any User
dspportstats	No	Any	Any User
dsprscrprtn	No	Any	Any User
dpsarcnt	No	Any	Any User
dpsarcnts	No	Any	Any User
dpservrate	No	Any	Super Group (0)
dpslftst	No	Any	Any User
dpslftsttbl	No	Any	Any User
dspstatparms	No	Any	Any User
dsptaskinfo	No	Any	Service Group (-1)
dsptotals	No	Any	Any User
dsptrafficgen	No	Any	Any User
dspunit391	No	Active	Any User
i	No	Any	Service Group (-1)
memShow	No	Any	Any User
myid	No	Any	Any User
oldcnfcdscrprtn	Yes	Active	Group 1
queDsp	No	Active	Any User
runslftstno	No	Any	Any User
setcmdc	No	Any	Any User
setpagemode	No	Any	Any User
shellConn	Yes	Any	Strata Group (-2)
tstcon	No	Active	Group 4
tstconsti	No	Active	Group 4
tstdelay	No	Active	Group 4
tstdelaysti	No	Active	Group 4
upport	Yes	Active	Group 2
version	No	Any	Any User
xclrchancnt	No	Any	Group 3
xclrportcnt	No	Any	Group 3
xcnfalm	Yes	Active	Service Group (-1)
xcnfalment	Yes	Active	Group 3
xcnfchan	Yes	Active	Group 2
xcnfln	Yes	Active	Service Group (-1)
xcnfport	Yes	Active	Group 1
xdspchan	No	Any	Any User
xdspchancnt	No	Any	Any User
xdspchans	No	Any	Any User
xdspln	No	Any	Any User
xdsplns	No	Any	Any User
xdspport	No	Any	Any User
xdspportcnt	No	Any	Any User
xdspports	No	Any	Any User
clralm	No	Any	Group 5

popeye3.1.3.FRSM.a >

Example 1-340 Display VISM card command suite

```
spirit1.1.VISM.a > help
?
Help
addchan
addcon
addendpt
addln
addlnloop
chkflash
clralm
clralmct
clralmcts
clralms
clrmcsgcnt
clrsarcnt
clrsarcnts
clrscrn
clrtaskinfo
cnfalm
cnfcompsize
cnfcompvad
cnfdomain
cnfecancnt
cnfecanidle
cnfecannoise
cnfecannr
cnfecannrn
cnfecanrec
cnfecantail
cnfecantone
cnfln
cnfsuip
cnfvismip
delchan
delcon
delendpt
delln
dellnloop
dmShellConn
dspalm
dspalmcnf
dspalmcnt
dspalms
dspcarddsp
dspcd
dspchan
dspchans
dspcon
dspcons
dspdomain
dspendpt
dspendpts
dsplinedsp
dspln
dsplns
dspmsgcnt
dpsarcnt
dpsarcnts
dpsuip
dsptaskinfo
dsvismip
i
memShow
```

```
shellConn  
versionDisplay CESH card command suite
```

Example 1-341 Display CESM card command suite

```

porky.1.12.CESM.a > help
Command          Logging   State   Priority
-----
?                No       Any     Any User
Help             No       Any     Any User
addcdrsoprtn    No       Any     Any User
addchan         Yes      Active  Group 2
addcon          Yes      Active  Group 2
addln           Yes      Active  Group 1
addlnloop       Yes      Active  Service Group (-1)
addport         Yes      Active  Group 1
addrscprtn     No       Any     Strata Group (-2)
chkflash        No       Any     Strata Group (-2)
clear           No       Any     Any User
clralm          No       Any     Group 5
clralmcnt       No       Any     Group 5
clralmcnts      No       Any     Group 5
clralms         No       Any     Group 5
clrcderrs       No       Any     Super Group (0)
clrchanant      No       Any     Group 5
clrchanants     No       Any     Group 3
clrmcgcnt       No       Any     Group 5
clrsarant       No       Any     Group 5
clrsarants      No       Any     Group 5
clrscrn         No       Any     Any User
clrslftst       No       Any     Any User
clrtaskinfo     No       Any     Service Group (-1)
cls             No       Any     Any User
cnfcdprtntype   No       Any     Any User
cnfcdrsoprtn    No       Any     Any User
cnfchan         Yes      Active  Group 2
cnfcon          Yes      Active  Group 2
cnfln           Yes      Active  Group 1
cnfportrsoprtn No       Any     Any User
cnfrsoprtn      No       Any     Strata Group (-2)
cnfslftst       Yes      Active  Any User
cnfswparms      No       Any     Any User
delcdrsoprtn    No       Any     Any User
delchan         Yes      Active  Group 2
delchans        Yes      Active  Group 1
delcon          Yes      Active  Group 2
delln           Yes      Active  Group 1
dellnloop       Yes      Active  Service Group (-1)
delport         Yes      Active  Group 1
delports        Yes      Active  Group 1
delrsoprtn      No       Any     Strata Group (-2)
dspalm          No       Any     Any User
dspalmcnf       No       Any     Any User
dspalmcnt       No       Any     Any User
dspalms         No       Any     Any User
dspcd           No       Any     Any User
dspcderrs       No       Any     Any User
dspcdprtntype   No       Any     Strata Group (-2)
dspcdrsoprtn    No       Any     Any User
dspchan         No       Any     Any User
dspchanant      No       Any     Any User
dspchans        No       Any     Any User
dspcon          No       Any     Any User
dspcons         No       Any     Any User
dspfeature      No       Any     Strata Group (-2)
dsplcn          No       Active  Any User
dspln           No       Any     Any User
dsplns          No       Any     Any User

```

dspmsgcnt	No	Any	Any User
dspport	No	Any	Any User
dspportrscprtn	No	Any	Any User
dspports	No	Any	Any User
dpsarcnt	No	Any	Any User
dpsarcnts	No	Any	Any User
dpslftst	No	Any	Any User
dpslftsttbl	No	Any	Any User
dspstatparms	No	Any	Any User
dsptaskinfo	No	Any	Service Group (-1)
i	No	Any	Service Group (-1)
memShow	No	Any	Any User
myid	No	Any	Any User
oldcnfcdrrscprtn	No	Any	Any User
oldcnfportrscprtn	No	Any	Any User
runslftstno	No	Any	Any User
setpagemode	No	Any	Any User
shellConn	Yes	Any	Strata Group (-2)
tstchan	No	Active	Group 4
tstchansti	No	Active	Group 4
tstcon	No	Active	Group 4
tstconsti	No	Active	Group 4
tstdelay	No	Active	Group 4
tstdelaysti	No	Active	Group 4
version	No	Any	Any User
xclrchanct	No	Any	Group 3
xcnfalm	Yes	Active	Service Group (-1)
xcnfalmcnt	Yes	Active	Group 3
xcnfcdprtntype	No	Any	Strata Group (-2)
xcnfcdrrscprtn	No	Any	Strata Group (-2)
xcnfchan	Yes	Active	Group 2
xcnfln	Yes	Active	Service Group (-1)
xcnfport	Yes	Active	Group 1
xcnfrscprtn	No	Any	Strata Group (-2)
xdspchan	No	Any	Any User
xdspchancnt	No	Any	Any User
xdspchans	No	Any	Any User
xdspln	No	Any	Any User
xdsplns	No	Any	Any User
xdspport	No	Any	Any User
xdspports	No	Any	Any User
clralm	No	Any	Group 5
clralmct	No	Any	Group 5

porky.1.12.CESM.a >

history

Use the **history** command to view the last 10 commands executed on the current card.

Full Name

Display Command History

Card(s) on Which This Command Executes

PXM

Syntax

history

Related Commands

cmdhistory

Attributes

Log: No

State: Any

Privilege: Any

Example 1-342 Display the last 10 commands executed on the PXM card

```
spirit4.1.8.PXM.a > history

Size of cmdHistory is currently 10 line(s)
 1 dspconcnt 2.39.45
 2 dsplmistats
 3 dsplmiloop
 4 dsplm
 5 clrportcnt
 6 dspportcnts
 7 dspportcnt
 8 dspportcnt 1
 9 dsplmistats
10 history

spirit4.1.8.PXM.a >
```

ifShow

Use the **ifShow** command to view the contents of all the currently configured interfaces.

Full Name

Show Interfaces

Card(s) on which This Command Executes

PXM

Syntax

ifShow

Related Commands

memShow, routeShow

Attributes

Log: No

State: Any

Privilege: Any

Example

```
spirit4.1.8.PXM.a > ifShow
lnPci (unit number 0):
  Flags: (0x63) UP BROADCAST ARP RUNNING
  Internet address: 172.29.23.149
  Broadcast address: 172.29.23.255
  Netmask 0xffff0000 Subnetmask 0xffffffff00
  Ethernet address is 00:c0:43:00:2d:c7
  Metric is 0
  Maximum Transfer Unit size is 1500
  599468 packets received; 34476 packets sent
  0 input errors; 0 output errors
  0 collisions
lo (unit number 0):
  Flags: (0x69) UP LOOPBACK ARP RUNNING
  Internet address: 127.0.0.1
  Netmask 0xff000000 Subnetmask 0xff000000
  Metric is 0
  Maximum Transfer Unit size is 4096
  4 packets received; 4 packets sent
  0 input errors; 0 output errors
  0 collisions
sl (unit number 0):
  Flags: (0x71) UP POINT-TO-POINT ARP RUNNING
  Internet address: 0.0.0.0
  Destination Internet address: 0.0.0.0
  Netmask 0xff000000 Subnetmask 0xff000000
  Metric is 0
  Maximum Transfer Unit size is 576
  0 packets received; 0 packets sent
  0 input errors; 0 output errors
  0 collisions
atm (unit number 0):
  Flags: (0x43) UP BROADCAST TRAILERS ARP RUNNING
  Internet address: 172.1.1.149
  Broadcast address: 172.1.1.255
  Netmask 0xffff0000 Subnetmask 0xffffffff00
  Ethernet address is 00:00:00:00:00:00
  Metric is 0
  Maximum Transfer Unit size is 1500
  0 packets received; 47272 packets sent
  0 input errors; 47272 output errors
  0 collisions
spirit4.1.8.PXM.a >
```

install

Use the **install** command after transferring a PXM firmware image (using the **downloadflash** command) during a system upgrade session.

Refer to Figure 1-6 to see an illustration of how the **install** command is used in the upgrade process.

Figure 1-6 Install Command Used in the Upgrade Process

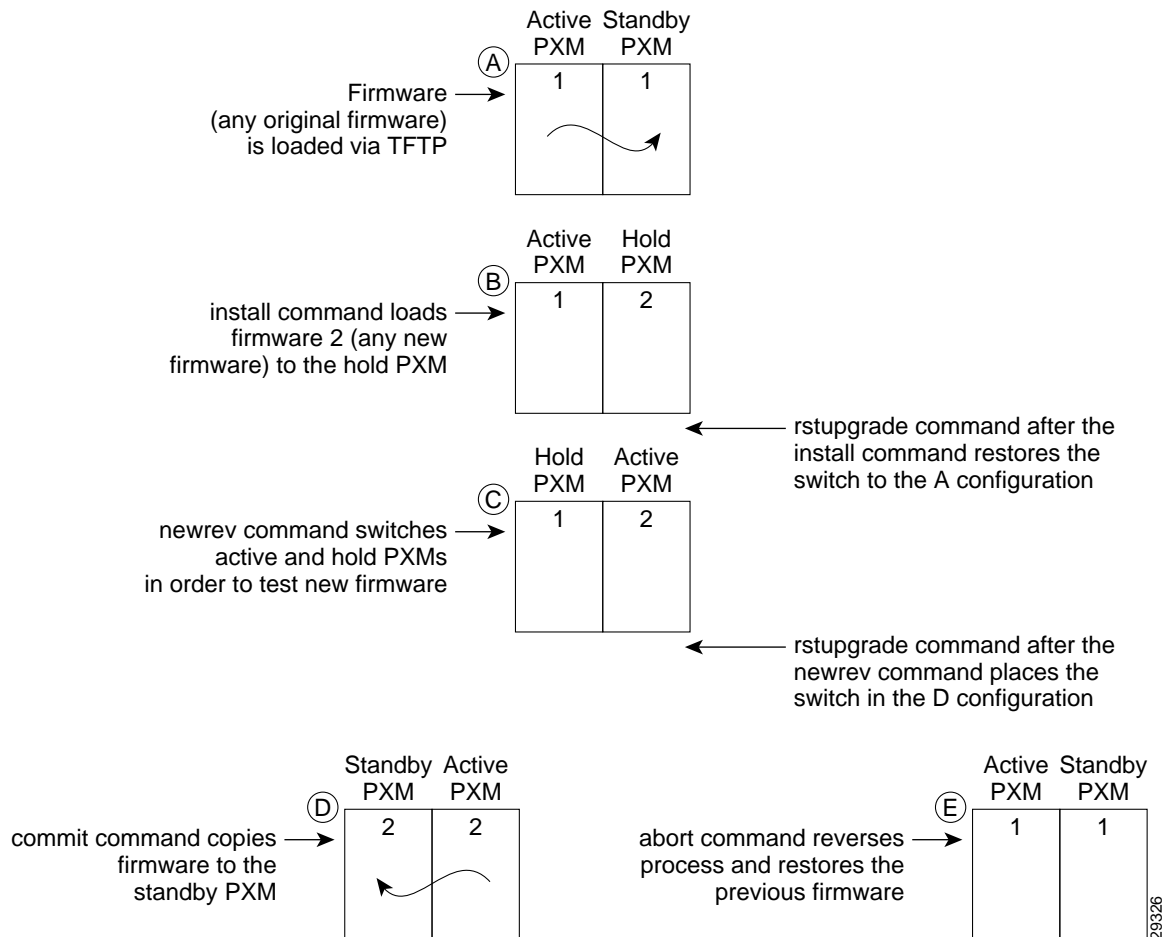

Full Name

Install the Firmware Load

Card(s) on Which This Command Executes

PXM

Syntax

install [*bt*] [*sm* <*slot*>] <*version*>

Syntax Description

bt Backup boot.

sm <slot> Location of the service module card and the slot number.

version Firmware file version.

Related Commands

dspupgrade, rstupgrade, newrev, abort, commit, dspfwrevs, printrev

Attributes

Log: No State: Active Privilege: Any

Example 1-343 Begin loading firmware 1.1.10

```
NODENAME.1.7.PXM.a > install 1.1.10
this may take a while ...
install command completed ok.
please wait for the other card to enter the hold state.
```

Example 1-344 Begin loading firmware 1.1.10, no redundancy

```
NODENAME.1.8.PXM.a > install 1.1.10
redundancy is not available
the other card is not available
you are not in redundant mode,
do you want to try an ungraceful upgrade
(yes or no)?
```

Example 1-345 Begin ungraceful upgrade (with redundancy)

```
NODENAME.1.8.PXM.a > install 1.1.11
the new version is not compatible with the current version,
do you want to try an ungraceful upgrade
(yes or no)?
```

Example 1-346 Begin loading firmware on backup boot

```
NODENAME.1.8.PXM.a > install bt 1.1.11
writing pxm_bkup_masukawa.fw to flash...
Board recognised as a PXM1B board ...
Checksum size is 1261544 ...
Erasing the flash ....
FLASH erase complete
Downloading C:/FW/pxm_bkup_1.1.11.fw into the flash ...
verifying flash contents ....
Flash ok ....

Flash download completed ...
copying pxm_bt_1.1.11.fw to standby...
writing flash on other card...
command completed ok on both pxms.
The new boot code will be used after the next reset
```

Example 1-347 Errors encountered during install command on a PXM (multiple cases)

```
NODENAME.1.8.PXM.a > install 1.1.10
file "C:/FW/ComMat.dat" not found
A graceful upgrade cannot be performed; these two versions are not
compatible.
ERR: command "install" failed

NODENAME.1.8.PXM.a > install 1.1.13
FW version C:/FW/pxm_1.1.13.fw is not in the appropriate directory
ERR: command "install" failed

NODENAME.1.8.PXM.a > install 1.1.12
A graceful upgrade cannot be performed; these two versions are not
compatible.
ERR: command "install" failed

NODENAME.1.8.PXM.a > install bt 1.1.12
writing pxm_bkup_1.1.12.fw to flash...
Board recognised as a PXM1B board ...
Backup boot file not found in the FW directory ...
Cannot proceed ...
error writing to flash
ERR: command "install" failed
```

Example 1-348 Begin loading firmware on a Service Module

```
golden1.1.7.PXM.a > install sm 11 10.0.05
Do you want to proceed (Yes/No)? yes
```

Example 1-349 Begin loading firmware on a Service Module, no redundancy

```
NODENAME.1.8.PXM.a > install sm 5 10.0.05
you are not in redundant mode,
do you want to try an ungraceful upgrade
(yes or no)?
```

Example 1-350 Begin loading firmware for a Service Module for backup boot

```
NODENAME.1.8.PXM.a > install bt sm 5 FR8_BT_1.0.01
downloading and burning flash on SM 5...
Command completed ok
The new boot code will be used after the next reset
```

Example 1-351 Errors encountered during install command on an SM (multiple cases)

```
NODENAME.1.8.PXM.a > install sm 5 1.1.11

Incorrect version : 1.1.11
Version 1.1.11 is not available
ERR: command "install" failed

NODENAME.1.8.PXM.a > install bt sm 5 1.1.11

Incorrect version : 1.1.11
The file is not found
ERR: command "install" failed
```

logout

Use the **logout** command to exit the current CLI shell.

Full Name

Log Out

Card(s) on Which This Command Executes

PXM, FRSM, AUSM, CISM, VISM

Syntax

logout

Related Commands

bye, exit

Attributes

Log: Yes

State: Any

Privilege: Any

Example 1-352 Log out of the current CLI shell

```
spirit4.1.8.PXM.a > logout
```

```
(session ended)
```

ls

Use the **ls** command to list the contents of the working directory. The filename is listed for each entry. The total space of the file system and free space is also summarized at the end of the output.

Full Name

List

Card(s) on Which This Command Executes

PXM

Syntax

ls

Related Commands

cd, pwd, rename, remredir, deltree, copy

Attributes

Log: No

State: Any

Privilege: Any

Example

```
raviraj.1.7.PXM.a > ls
SM
FW
DIAG
STATS
TMP
CNF
RPM
LOG
clrDB
upgrade.state
config.sys
DB
frsm_vhs_5.0.01_27May99_1_rmenon.fw
frsm_vhs_5.0.01_16Jun99_1_rmenon.fw
```

```
In the file system :
total space : 819200 K bytes
free space : 700583 K bytes
```

```
raviraj.1.7.PXM.a >
```

memShow

Use the **memShow** command to view the current memory map.

Full Name

Show Memory

Card(s) on Which This Command Executes

PXM

Syntax

memShow

Related Commands

ifShow, routeShow

Attributes

Log: No State: Any Privilege: Any

Example 1-353 Show current memory allocation on the PXM

```
spirit4.1.1.8.PXM.a > memShow

status      bytes      blocks  avg block  max block
-----
current
free        2967104      37      80192     2879008
alloc       2561600     1774     1443      -
cumulative
alloc       241511616  1019558  236       -

spirit4.1.1.8.PXM.a >
```

mkdir

Use the **mkdir** command to create a new directory.

Full Name

Make directory

Card(s) on Which This Command Executes

PXM

Syntax

mkdir *<path_name>*

Syntax Description

path_name Name of the target directory.

Related Commands

dir, **rmdir**

Attributes

Log: Yes

State: Any

Privilege: SERVICE_GP

modbert

Use the **modbert** command to inject errors into the bit stream for BERT testing.

Full Name

Modify BERT

Card(s) on Which This Command Executes

PXM

Syntax

modbert <slot>

Syntax Description

slot Slot number

Related Commands

Attributes

Log: Yes State: Active Privilege: GROUP_1

moddsx3bert

Use the **moddsx3bert** command to inject multi-rate errors into the BERT bit stream.

Full Name

Modify DSX3 BERT

Card(s) on Which This Command Executes

FRSM 2T3E3, CESMT3

Syntax

```
moddsx3bert <EIR>
```

Syntax Description

EIR Value to define error insertion rate.

- 0 = no error
- 2 = 1 in 10
- 3 = 1 in 100
- 4 = 1 in 1000
- 5 = 1 in 10**4
- 6 = 1 in 10**7

Related Commands

acqdsx3bert, cnfdsx3bert, deldsx3bert, dspdsx3bert, startdsx3bert, xcfnfdsx3bert, xdspdsx3bert

Attributes

Log: No State: Active Privilege: Any user

Example 1-354 Inject EIR 1-in-10 for the current BERT session

```
popeye1.1.21.CESMT3.a > moddsx3bert 2  
popeye1.1.21.CESMT3.a >
```

Example 1-355 Look at results

```
popeye1.1.21.CESMT3.a > dspdsx3bert
Bert Control:                Modify dsx3Bert
Bert Resource Status State:  In Use
Bert Owner:                  CLI
Bert Status:                 In Sync
Bert Test Medium:           Line
Bert Port:                   1
Line Number :                1
Bert Mode :                  bertPatternTest
Bert Pattern :               doubleOneZero
Loopback type:               metallicLoopback
Start time (secs.)          14:14:44
Start Date                   FRI JUL 02 1999
Bit countupper:              3
Bit countlower:              389194075
Bit Error Countupper         0
Bit Error Countlower         14363002
Error Insertion Rate:        oneInTenPowerTwo
Error Insertion count:       0
                             DSX3 BERT in Sync
Syntax : dspdsx3bert
```

mv

Use the **mv** command to rename a file or directory.

Full Name

Move

Card(s) on Which This Command Executes

PXM

Syntax

```
mv <path_name> <tgt_path_name>
```

Syntax Description

path_name Name of the existing file or directory.

tgt_path_name Name of the target file or directory.

Related Commands

rename

Attributes

Log: Yes

State: Any

Privilege: SUPER_GP

myid

Use the **myid** command to view information about the user of the current terminal session.

Full Name

My Identification

Card(s) on Which This Command Executes

PXM, FRSM, AUSM, CESH, VISM

Syntax

myid

Related Commands

None

Attributes

Log: No State: Any Privilege: Any

Example 1-356 Display the login name of the current user—"stratacat" in this case

```
manish.1.7.PXM.a > myid

  User ID:      cisco
  Access Level: CISCO_GP
  Terminal Port: telnet.01

manish.1.7.PXM.a >
```



newrev

Use the **newrev** command to complete an upgrade/downgrade procedure on the PXM. This operation assumes that the **install** command has been successfully completed.

When this command executes normally, no output is returned, but the card is reset.

Refer to Figure 1-7 for an illustration of how the **newrev** command is used in the firmware upgrade process.

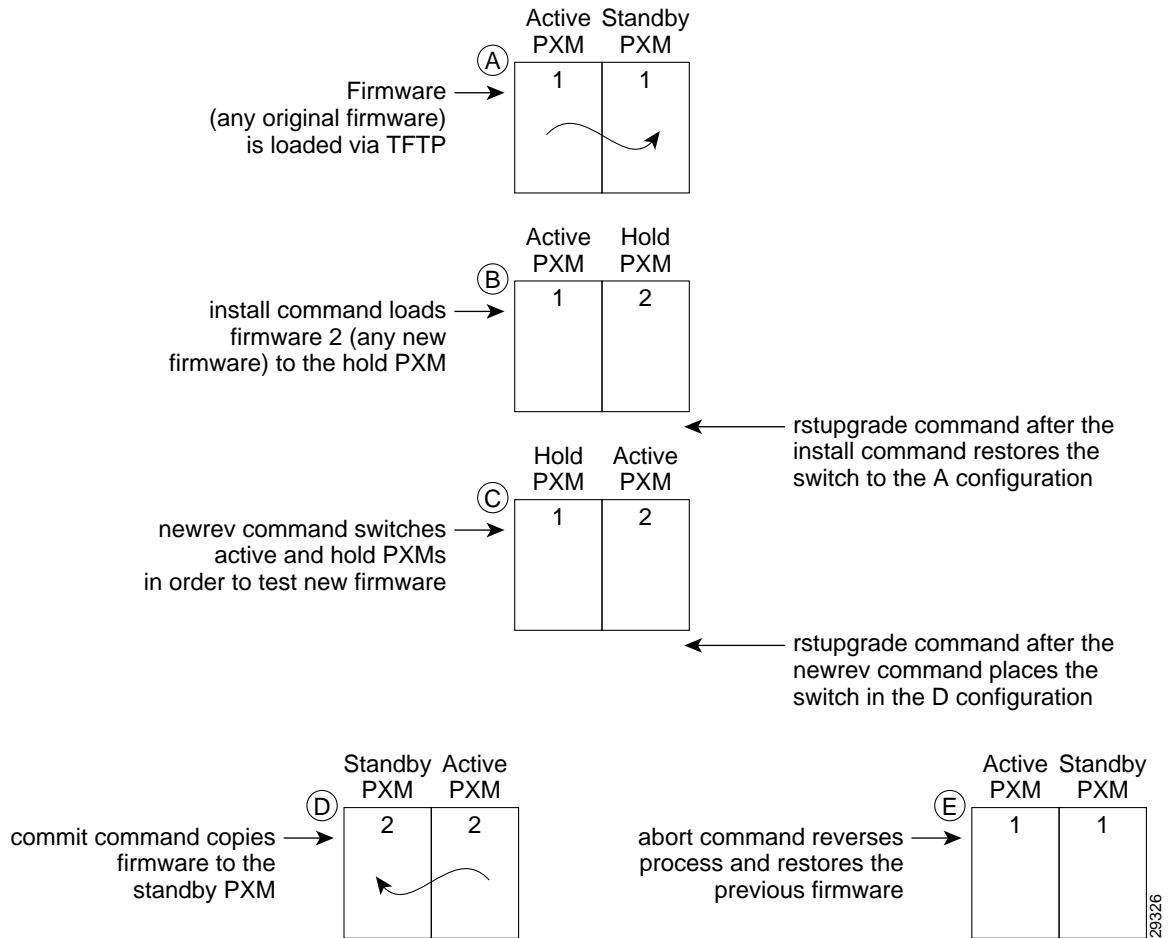
Figure 1-7 newrev Command Used in the Upgrade Process



Full Name
New revision

Card(s) on Which This Command Executes
PXM

Syntax

newrev [sm <slot>] <version>

Note The “sm <slot>” parameter is optional; used only when a service module image is being upgraded.

Syntax Description

slot Slot number of the service module slot that needs to be upgraded or downgraded.

version Firmware version.

Related Commands

rstupgrade, dspupgrade, install, abort, commit, dspfwrevs, printrev

Attributes

Log: Yes State: Active Privilege: Any

Example 1-357 Loading firmware errors (multiple cases)

```
NODENAME.1.8.PXM.a > newrev 1.1.11
in 'upgrade idle', must be in 'upgrade install'
ERR: command "newrev" failed

NODENAME.1.8.PXM.a > newrev 1.1.11
1.1.11 is not the PXM FW secondary image
ERR: command "newrev" failed
```

Example 1-358 Loading firmware on a Service Module

```
golden1.1.7.PXM.a > newrev sm 11 10.0.05
Do you want to proceed (Yes/No)? yes
```

Example 1-359 Loading firmware error for a Service Module

```
golden1.1.7.PXM.a > newrev sm 11 10.0.05

Incorrect version : 10.0.05
usage: newrev [sm <slot>] <version>
ERR: command "newrev" failed
```

pagemode

Use the **pagemode** command to adjust the way information is presented in your console display. Set pagemode off to enable continuous scrolling of displayed information, or set pagemode on to view incremental portions of the display.

Full Name

Page mode

Card(s) on Which This Command Executes

PXM

Syntax

pagemode [off]

Syntax Description

off Present uninterrupted results of command.

Related Commands

None

Attributes

Log: No

State: Any

Privilege: Any User

Example: Set display for continuous scroll

```
raviraj.1.7.PXM.a > pagemode off  
Value of pageMode is now turned OFF  
  
raviraj.1.7.PXM.a >
```

Example: Set display for incremental views

```
raviraj.1.7.PXM.a > pagemode on  
Value of pageMode is now turned ON  
  
raviraj.1.7.PXM.a >
```

passwd

Use the **passwd** command to set the password on the PXM.

Note The default password is *newuser*.

Full Name

Password

Card(s) on Which This Command Executes

PXM

Syntax

password

Related Commands

cnfpasswd

Attributes

Log: Yes

State: Active

Privilege: Any User

Example 1-360

```
raviraj.1.7.PXM.a > passwd
Enter password:
(default password "newuser" will be used)

raviraj.1.7.PXM.a >
```

ping

Use the **ping** command to send an ICMP packet to a destination address to find out if the host is operational.

Full Name

Ping

Card(s) on Which This Command Executes

PXM

Syntax

ping <IP_Addr> [<Num_Packets>]

Syntax Description

IP_Addr IP address of the destination host in dotted decimal format.

Num_Packets Number of packets, in the range 0-65535.

- 0 = infinite
- 3 = default

Related Commands

None

Attributes

Log: No

State: Any

Privilege: Any

Example

```
raviraj.1.7.PXM.a > ping 172.29.23.148
PING 172.29.23.148: 56 data bytes
64 bytes from 172.29.23.148: icmp_seq=0. time=0. ms
64 bytes from 172.29.23.148: icmp_seq=1. time=0. ms
64 bytes from 172.29.23.148: icmp_seq=2. time=0. ms
----172.29.23.148 PING Statistics----
3 packets transmitted, 3 packets received, 0% packet loss
round-trip (ms)  min/avg/max = 0/0/0

raviraj.1.7.PXM.a >
```

printrev

Use the **printrev** command to view the primary and secondary versions of firmware saved in the BRAM.

Full Name

Display Firmware Version

Card(s) on Which This Command Executes

PXM

Syntax

printrev

Related Commands

dspupgrade, rstupgrade, newrev, dspfwrevs, copy, install, commit, abort

Attributes

Log: No

State: Any

Privilege: Any

Example 1-361 Display the version of firmware running in both PXM cards

```
spirit4.1.1.8.PXM.a > printrev  
  
primary : 1.0.00  
secondary : 1.0.00  
  
spirit4.1.1.8.PXM.a >
```

pwd

Use the **pwd** command to view the current working directory on the PXM.

Full Name

Present Working Directory

Card(s) on Which This Command Executes

PXM

Syntax

pwd

Related Commands

dir, mkdir, rmdir, vxpwd

Attributes

Log: No

State: Any

Privilege: Any

Example

```
raviraj.1.7.PXM.a > pwd  
C:  
raviraj.1.7.PXM.a >
```

remove

Use the **remove** command to delete a file or directory from the PXM hard drive.

Full Name

Remove

Card(s) on Which This Command Executes

PXM

Syntax

remove <*path_name*>

Syntax Description

path_name Name of an existing file or directory.

Related Commands

None

Attributes

Log: Yes

State: Any

Privilege: SUPER_GP

rename

Use the **rename** command to modify the current name of a file or directory.

Full Name

Rename

Card(s) on Which This Command Executes

PXM

Syntax

rename <path_name> <tgt_path_name>

Syntax Description

path_name Name of an existing file or directory.

tgt_path_name Name of target file or directory.

Related Commands

vxrename

Attributes

Log: Yes State: Any

Privilege: SUPER_GP

resetcd

Use the **resetcd** command to reset either the hardware of a selected service module or the failure history of the current card.

Using the **resetcd** command without defining a slot number results in an ungraceful (disruptive) upgrade. This is the fastest method to upgrade a card, but interrupts service.

A graceful (non-disruptive) upgrade requires that the **install**, **newrev**, and **commit** commands have already been executed, and that the card is identified in the command string.

Full Name

Reset Card

Card(s) on Which This Command Executes

PXM

Syntax

resetcd [*slot number*]

Syntax Description

slot number Slot number, in the range 1–32.

Related Commands

install, **newrev**, **commit**

Attributes

Log: Yes State: Active Privilege: 1–3

Example 1-362

```
porky.1.7.PXM.a > resetcd 5
```

resetsys

Use the **resetsys** command to reset the system.

Full Name

Reset System

Card(s) on Which This Command Executes

PXM

Syntax

resetsys

Related Commands

resetcd

Attributes

Log: Yes

State: Active

Privilege: GROUP_3

Example 1-363 Reset the System

```
porky.1.7.PXM.a > resetsys
Do you want to proceed (Yes/No)? y
Syncing .....
Warning: firmware reset on active PXM card by cisco@telnet.01 (172.29.52.18)
(session ended)
```

restoreallcnf

restoreallcnf

Restore All Configurations

Restores all configuration files saved to the CNF directory on the hard drive. The saved configuration is the result of a prior execution of the **saveallcnf** command.

To see a list of existing configurations that have been zipped by **saveallcnf**, cd to the C drive and list the contents of the CNF directory.

You may want to use a saved configuration file to restore the configuration on another node, or to put it somewhere safe on a workstation. In order to move it off of a hard disk and use it with the **restoreallcnf** command on another node, TFTP the file off of the hard disk. See the example below, where 172.29.xx.xx is the IP address. To put the file on another node, use the TFTP put instead of TFTP get, then run the **restoreallcnf** command.

```
TFTP a configuration file off of the hard disk
# tftp 172.29.xx.xx
tftp> bin
tftp> get CNF/sj885168_0226011840.zip
Received 366160 bytes in 1.7 seconds
tftp> quit
#
```

Card(s) on Which This Command Executes

PXM

Syntax

```
restoreallcnf [-f] <FILENAME> [-v]
```

Syntax Description

-f	Specifies the filename of the zipped version of the configuration.
<i>FILENAME</i>	Filename to be stored.
-v	(Optional) Specifies that a list of the restored configuration files goes to the default printer. The default is no printout. In releases prior to Release 1.1.34, this option should be used, since it will not be automatically displayed on the monitor after the restoreallcnf command is executed.

Related Commands

clrallcnf, saveallcnf

Attributes

Log: **Yes** State: **Active** Privilege: **Super Group**

rnmnd

Use the **rnmnd** command to renumber a routing node. This command is not applicable for a feeder node, and by default is set to 1.

Full Name

Renumber Node

Card(s) on Which This Command Executes

PXM

Syntax

rnmnd <1 / 2>

Syntax Description

<1 | 2> 1 = feeder node
 2 = routing node

Related Commands

routeDelete, routeNetAdd, routeShow, routestatShow

Attributes

Log: No State: Any Privilege: GROUP 1

Example 1-364 Renumber node error on a feeder node

```
NODENAME.1.8.PXM.a > rnmnd 2  
Node renumber not allowed for Feeder Node
```

routeShow

Use the **routeShow** command to view the current IP routing of the network layer of the operating system.

Full Name

Show Routing

Card(s) on Which This Command Executes

PXM

Syntax

routeShow

Related Commands

routeStatShow

Attributes

Log: No

State: Any

Privilege: Any

Example 1-365 Display the current IP routing of the network layer of the operating system

```
spirit4.1.1.8.PXM.a > routeShow
```

```
ROUTE NET TABLE
destination      gateway          flags  Refcnt  Use      Interface
-----
0.0.0.0          172.29.23.149   1      1        21778    lnPci0
0.0.0.0          172.29.23.1     3      0        2755     lnPci0
172.1.1.0        172.1.1.149    1      0         0        atm0
172.29.23.0      172.29.23.149   1      2        5275     lnPci0
-----
```

```
ROUTE HOST TABLE
destination      gateway          flags  Refcnt  Use      Interface
-----
0.0.0.0          0.0.0.0         5      0         0        sl0
127.0.0.1        127.0.0.1       5      1         0        lo0
172.29.23.3      172.1.1.149    5      0        3555     atm0
172.29.23.5      172.1.1.149    5      0        3304     atm0
172.29.23.7      172.1.1.149    5      0        3335     atm0
171.71.29.18     172.1.1.149    5      0        3304     atm0
172.29.23.18     172.1.1.149    5      0        3304     atm0
172.29.23.28     172.1.1.149    5      0        6127     atm0
172.29.23.29     172.1.1.149    5      1        6065     atm0
171.71.29.32     172.1.1.149    5      0        5842     atm0
171.71.29.44     172.1.1.149    5      0        3304     atm0
172.29.23.53     172.1.1.149    5      0        3304     atm0
171.71.29.59     172.1.1.149    5      0        3304     atm0
171.71.28.126    172.1.1.149    5      0        3309     atm0
-----
```

```
spirit4.1.1.8.PXM.a >
```

routeStatShow

Use the **routeStatShow** command to view the current IP routing statistics for the network layer of the operating system.

Full Name

Show Routing Statistics

Card(s) on Which This Command Executes

PXM

Syntax

routeStatShow

Related Commands

routeShow

Attributes

Log: No

State: Any

Privilege: Any

Example 1-366 Display the current IP routing statistics for the network layer of the operating system

```
spirit4.1.8.PXM.a > routeStatShow

routing:
  0 bad routing redirect
  0 dynamically created route
  0 new gateway due to redirects
  0 destination found unreachable
 11095 uses of a wildcard route

spirit4.1.8.PXM.a >
```

rstupgrade

Use the **rstupgrade** command to cancel the software upgrade process. In normal circumstances, the **abort** command is the best way to stop the software upgrade process. However, if a hardware failure or other error occurs during the installation, run the **rstupgrade** command to cancel the installation. Run the **dspupgrade** command to display the status. The status “upgrade idle” indicates that the upgrade has been cancelled. You then can correct the cause of the error, and start the upgrade process again.

Refer to Figure 1-8 for an illustration of how the **rstupgrade** command is used in the upgrade process.

Figure 1-8 rstupgrade Command Used in the Upgrade Process

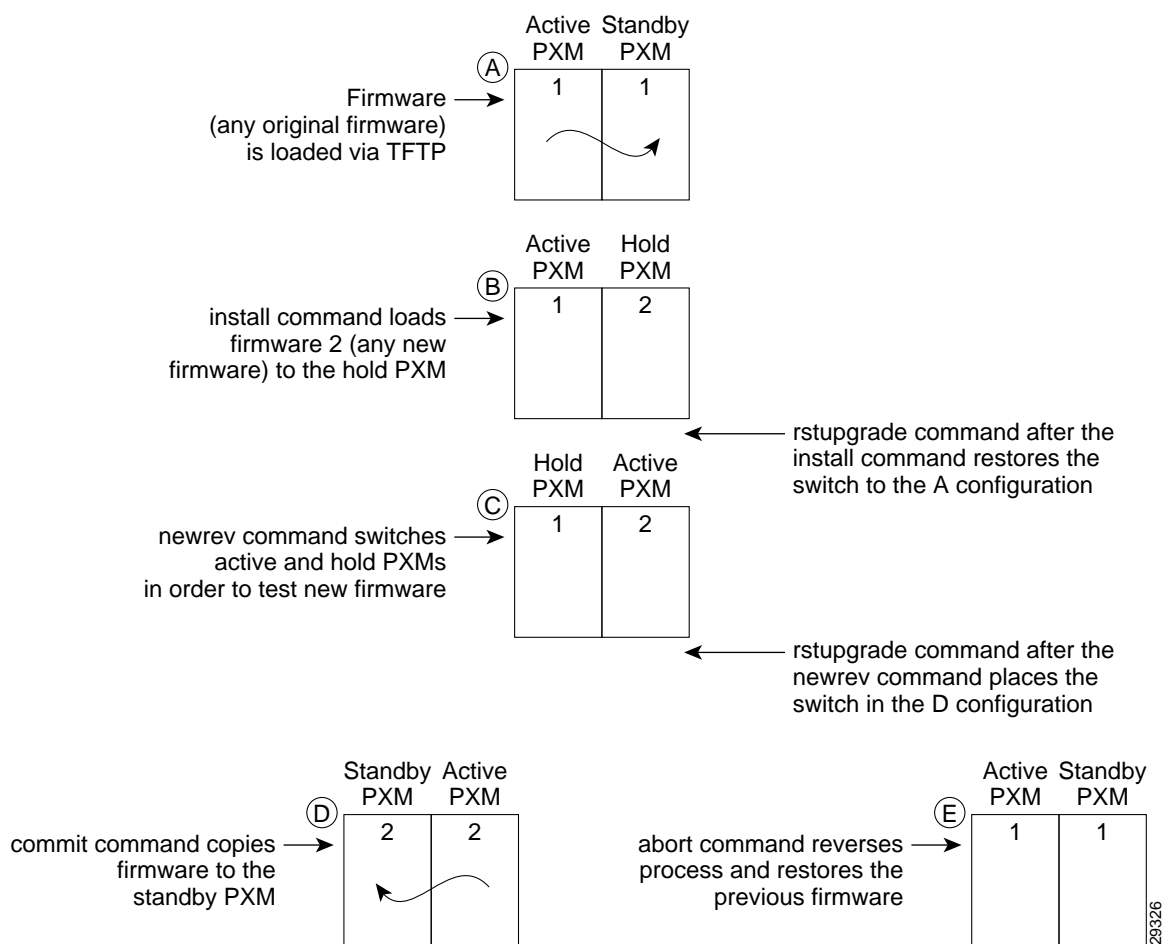

Full Name
Reset Upgrade

Card(s) on Which This Command Executes
PXM

Syntax

rstupgrade

Related Commands

dspupgrade, newrev, install, abort, commit, dspfwrevs, printrev

Attributes

Log: No State: Active Privilege: Any

Example 1-367 Reset upgrade and display upgrade

```
spirit4.1.1.8.PXM.a >rstupgrade
spirit4.1.1.8.PXM.a > dspupgrade

active: 'upgrade idle'
standby: 'upgrade idle'

spirit4.1.1.8.PXM.a >
```

runslftstno

Use the **runslftstno** command activate the self-test for the specified self-test number on the current card.

Full Name

Run Self-Test Number

Card(s) on Which This Command Executes

FRSM, AUSM, CESM

Syntax

runslftstno <Test #>

Syntax Description

Test # Number of the test to run during this session. If this parameter is omitted, all tests are run.

Related Commands

None

Attributes

Log: Yes State: Active Privilege: 1–2

Examples

This section contains the following examples.

- Run all self-tests on an installed AUSM card.
- Run self-test on an installed FRSM 2CT3 card.
- Run specified self-test on a current card.

Example 1-368 Run all self-tests on the current AUSM card

```
spirit.1.19.AUSM8.a > runslftstno

Test #  Test Name                Thold Fail Pass Last Enab Destr Card Rst
  1     DRAM access test          1     0   0   P   Y   N   Y
  2     SRAM access test          1     0   0   P   Y   N   Y
  3     GRAM access test          1     0   0   P   Y   N   Y
  4     BRAM checksum test        1     0   0   P   Y   Y   Y
  5     CODE checksum test        1     0   0   P   Y   N   Y
  6     Line loopback test        1     0   0   P   Y   Y   Y
  7     CellBus test              1     0   0   P   Y   N   N
  8     DPRAM test                1     0   0   P   Y   N   Y
  9     CSERAM test               1     0   0   P   Y   N   Y
 10     CAM test                  1     0   0   P   Y   Y   Y
 11     IMA grp lpbk test         1     0   0   P   Y   Y   Y
runslftstno "Test #"

spirit.1.19.AUSM8.a >
```

Example 1-369 Run all self-tests on the current FRSM card

```
spirit.1.1.FRSM.a > runslftstno

Test #  Test Name                Thold Fail Pass Last Enab Destr Card Rst
  1     DRAM access test          1     0   0   P   Y   N   Y
  2     SRAM access test          1     0   0   P   Y   N   Y
  3     GRAM access test          1     0   0   P   Y   N   Y
  4     BRAM checksum test        1     0   0   P   Y   N   Y
  5     CODE checksum test        1     0   0   P   Y   N   Y
  6     Line loopback test        1     0   0   P   Y   Y   Y
  7     M32 test                  1     0   0   P   Y   Y   N
  8     Data loopback test        1     0   0   P   N   Y   Y
  9     CellBus test              1     0   0   P   Y   N   N
runslftstno "Test #"

spirit.1.1.FRSM.a >
```

Example 1-370 Run all self tests on the current FRSM-2CT3 card

```
spirit.1.3.VHS2CT3.a > runslftstno

Test #  Test Name                Thold Fail Pass Last Enab Destr Card Rst
  1     CPU DRAM access test      1     0   0   P   Y   N   Y
  2     SAR self test              1     0   0   P   Y   N   Y
  3     ISE self test              1     0   0   P   Y   N   Y
  4     ESE self test              1     0   0   P   Y   N   Y
  5     CODE checksum test        1     0   0   P   Y   N   Y
  6     Line loopback test        1     0   0   P   Y   Y   Y
  7     FREEDM test                1     0   0   P   Y   Y   Y
  8     Data loopback test        1     0   0   P   Y   Y   Y
  9     CellBus test              1     0   0   P   Y   N   N
runslftstno "Test #"

spirit.1.3.VHS2CT3.a >
```

Example 1-371 Run the self test with the specified self test number on the current card

```
spirit.1.3.VHS2CT3.a > runslftstno 1
Test Number 1 Result: PASS

spirit.1.3.VHS2CT3.a >
```

saveallcnf

Save All Configuration

Save All Configurations—save all configuration files to a zip file on the hard drive.

Warning The shelf must not provision new circuits while this command is running. Do not run this command unless the shelf configuration is stable or you risk corrupting the saved configuration file.

The **saveallcnf** command saves all configurations to a zipped file in the CNF directory on the hard drive. The zip file can then be used to restore the configuration at a later time. This command takes significant time to execute, so a warning message prompts you for confirmation before the system performs the task. Upon completion, the system displays the name of the saved configuration file, in the form `nodename.zip`. Be sure to use the `-v` parameter with this command in releases prior to 1.1.34 in order to display the file name.

The system stores up to three zipped configuration files. If you want to save more than two configurations, use FTP to transfer the files to another device.

After you execute the **saveallcnf** command, you may want to use the saved configuration file to restore the configuration on another node, or to put it somewhere safe on a workstation. In order to do this, you can TFTP the file off of the hard disk. See the example below, where 172.29.xx.xx is the IP address.

Example 1-372 TFTP a configuration file off of the hard disk

```
# tftp 172.29.xx.xx
tftp> bin
tftp> get CNF/sj885168_0226011840.zip
Received 366160 bytes in 1.7 seconds
tftp> quit
#
```

To restore the system configuration, use the **restoreallcnf** command. To abort a configuration save, use **abortallsaves** command.

Card(s) on Which This Command Executes

PXM

Syntax

saveallcnf `-v`

Syntax Description

`-v` Command delineator that prints the configuration file. Use this delineator when running this command in releases prior to 1.1.34. In prior releases, the filename is not returned as a display on the screen. Using the `-v` parameter prints out the filename of the saved configuration file.

Related Commands

clrallcnf, **restoreallcnf**

Attributes

Log: **Yes**

State: **Active**

Privilege: **Any**

sesntimeout

Use the **sesntimeout** command to define maximum idle time, in seconds, for the current session. If you do not specify a timeout period in seconds, the system displays the current timeout. To disable the session timeout function, enter a 0.

Full Name

Session Timeout

Card(s) on Which This Command Executes

PXM

Syntax

sesntimeout [*time_out*]

Syntax Description

time_out Number of idle time seconds allowed for the session.

Related Commands

None

Attributes

Log: No State: Any Privilege: Any

Examples

This section contains the following examples:

- Display the current timeout
- Modify the current timeout and display the new configuration

Example 1-373 Display the current timeout

```
spirit.1.7.PXM.a > sesntimeout
The timeout period for this session is currently 600 second(s)
spirit.1.7.PXM.a >
```

Example 1-374 Set the session timeout threshold to 12 minutes (720 seconds)

```
spirit.1.7.PXM.a > sesntimeout 720
The timeout period for this session is now set to 720 second(s)
spirit.1.7.PXM.a >
```

shutdisk

Use the **shutdisk** command to quiesce the disk.

Note You must execute a **shutdisk** on the PXM prior to rebooting the PXM.

Note You must execute a **shutdisk** on the PXM prior to removing a PXM from the system.

Full Name

Shut Down the Disk

Card(s) on Which This Command Executes

PXM

Syntax

shutdisk

Related Commands

syncdisk, **formatdisk**

Attributes

Log: No

State: Any

Privilege: SUPER_GP

softswitch

Use the **softswitch** command to transfer control from the active primary service module to the active secondary (or redundant) service module. The primary service module will reboot and come up in standby mode. Use the **switchback** command to revert to normal operation after a **softswitch**.

Full Name

Switch to Redundant from Primary

Card(s) on Which This Command Executes

PXM

Syntax

softswitch <*PrimarySlotNum*> <*SecondarySlotNum*>

Syntax Description

PrimarySlotNum Slot number of the primary card, in the range 1–6, or 9–14, or 17–22, or 25–30.

SecondarySlotNum Slot number of the secondary card, in the range 1–6, or 9–14, or 17–22, or 25–30.

Related Commands

switchback, **addred**, **delred**, **dspre**

Attributes

Log: No

State: Active

Privilege: Any

startdsx3bert

Use the **startdsx3bert** command to start a BERT testing session. You must reset the BERT counters, using the **clrbertcntrs** command, prior to using the **startdsx3bert** command.

Full Name

Start DSX3 BERT

Card(s) on Which This Command Executes

FRSM 2T3E3, CESMT3

Syntax

startdsx3bert

Related Commands

acqdsx3bert, clrbertcntrs, cnfdsx3bert, dspdsx3bert

Attributes

Log: No State: Active Privilege: Any

Example 1-375 Start a bert testing session on the selected service module

```
popeye1.1.21.CESMT3.a > startdsx3bert  
popeye1.1.21.CESMT3.a >
```

switchapsln

Use the **switchapsln** command to control APS switching actions. This function applies to OC-3 and OC-12 lines.

Full Name

Switch APS Line

Card(s) on Which This Command Executes

PXM

Syntax

switchapsln *<line number>* *<operation>*

Syntax Description

<i>line number</i>	OC-3 or OC-12 line number on which to apply APS.
<i>operation</i>	Value to set type of APS switch functionality to use on the PXM line. <ul style="list-style-type: none">• 1 = clear• 2 = forced• 3 = manual• 4 = lock-out• 5 = service

Related Commands

addapsln, cnfapsln, delapsln, dspapsln

Attributes

Log: Yes State: Active Privilege: 1

switchback

Use the **switchback** command to revert to normal operation after a softswitch. The **switchback** command transfers control from the active secondary (or redundant) service module back to the active primary service module. The secondary (or redundant) service module will reboot and will come up in standby mode

Full Name

Switch Back to Primary from Redundant

Card(s) on Which This Command Executes

PXM

Syntax

switchback <PrimarySlotNum> <SecondarySlotNum>

Syntax Description

PrimarySlotNum Slot number of the primary card, in the range 1–6, or 9–14, or 17–22, or 25–30.

SecondarySlotNum Slot number of the secondary card, in the range 1–6, or 9–14, or 17–22, or 25–30.

Related Commands

softswitch, addred, delred, dspred

Attributes

Log: No State: Active Privilege: Any

switchcc

Use the **switchcc** command to transfer control of the MGX 8800 series shelf from the active PXM to the standby PXM. If a standby PXM is not available, the command is not executed.

During a config copy, this command is disabled. If the command is attempted during a config copy, a “Can’t execute, BRAM or FLASH is being updated” message is displayed.

Full Name

Switch Core Cards

Card(s) on Which This Command Executes

PXM

Syntax

switchcc

Related Commands

None

Attributes

Log: Yes State: Active Privilege: 1–3

Example 1-376 Attempt to switchcc without a standby PXM on the shelf

```
raviraj.1.7.PXM.a > switchcc
Do you want to proceed (Yes/No)? y

Core card redundancy unavailable

raviraj.1.7.PXM.a >
```

syncdisk

Use the **syncdisk** command to flush out the write buffers to the disk and put the device in standby mode. Use the **syncdisk** command before you remove the PXM card or reset the shelf.

Full Name

Synchronize Disk

Card(s) on Which This Command Executes

PXM

Syntax

syncdisk

Related Commands

formatdisk

Attributes

Log: No

State: Any

Privilege: Any

timeout

Use the **timeout** command to set maximum idle time, in seconds, for the current session on the PXM. If you do not specify a timeout period in seconds, the system displays the current timeout. To disable the session timeout function, enter a 0.

Full Name

Session Timeout

Card(s) on Which This Command Executes

PXM

Syntax

timeout [*time_out*]

Syntax Description

time_out Number of idle time seconds allowed prior to automatically logging off the current user.

Related Commands

sasntimeout

Attributes

Log: No State: Any Privilege: SuperUser

Examples

This section contains the following examples:

- Display the current timeout.
- Modify the current timeout and display the new configuration.

Example 1-377 Display the current timeout

```
spirit.1.7.PXM.a > timeout

The timeout period for this session is currently 600 second(s)

spirit.1.7.PXM.a >
```

Example 1-378 Set the session timeout threshold to 12 minutes (720 seconds)

```
spirit.1.7.PXM.a > timeout 720

The timeout period for this session is now set to 720 second(s)

spirit.1.7.PXM.a >
```

tstcon

Use the **tstcon** command to test the integrity of a connection between an MGX 8800 series card and a remote end within the WAN switching network by sending a single collection of supervisory cells to the remote end. The terminal displays only a pass or fail message.

Full Name

Test Connection

Card(s) on Which This Command Executes

PXM, FRSM, AUSM, CESM

Syntax: Service Modules

tstcon <channel number>

Syntax Description

channel number A number in the range appropriate for the card.

- FRSM
 - 8T1/E1 range = 16–1015
 - HS1/B range = 16–1015
 - T3/E3/HS2 range = 16–2015
 - 2CT3 range = 16–4015
- PXM range = 16–1024
- AUSM range = 16–1015
- CESM
 - 8T1/E1 range = 32–279
 - T3/E3, one connection starting at 32

Syntax: PXM

tstcon <con_id>

Syntax Description

con_id Connection identifier, in the format *port.vpi.vci*.

- Port range = 1–*n*, as appropriate for the physical installation
- *vpi* range = 1–4095
- *vci* range = 1–65535

Related Commands

dspcons, tstconseg, tstdelay

Attributes

Log: No State: Any Privilege: 1–4

Syntax: AUSM

tstcon <*port.VPI.VCI* | *channel number*>

Syntax Description

port.VPI.VCI Connection identifier, in the format *port.vpi.vci*.

- Port range = 1–*n*, as appropriate for the physical installation
- *vpi* range = 1–4095
- *vci* range = 1–65535

channel number Channel number, in the range 16–1015.

Related Commands

dspscons, tstconseg, tstdelay

Attributes

Log: No State: Any Privilege: 1–4

Example 1-379 Testing a connection on the current AUSM (using the port.VPI.VCI argument)

```
s1.1.12.AUSM8.a > tstcon 2.1.1
```

Example 1-380 Testing a connection on the current AUSM (using the channel number argument)

```
s1.1.12.AUSM8.a > tstcon 21
```

Output:
tstcon in progress

Test passed.

tstconseg

Use the **tstconseg** command to test the integrity of a connection between an MGX 8800 series card and service equipment (CPE) by sending a single collection of supervisory cells to the remote end. The terminal displays only a pass or fail message.

Full Name

Test Connection Segment

Card(s) on Which This Command Executes

PXM, AUSM-8T1E1

Syntax for PXM

tstconseg <channel number>

Syntax Description

channel number Channel number, in the range 16–4111.

Syntax for AUSM-8T1E1

tstconseg <port.VPI.VCI | channel number>

Syntax Description

port.VPI.VCI Port range = 1–n, as appropriate for the physical installation

VPI range = 1–4095

VCI range = 1–65535

chan_num Channel number, in the range 16–1015

Related Commands

dspscons, tstcon, tstdelay

Attributes

Log: No

State: Any

Privilege: 1–4

Example 1-381 Testing the connection between the current AUSM card and the service equipment (CPE) using the port.VPI.VCI argument

```
s1.1.12.AUSM8.a > tstconseg 2.1.1
Output:
tstcon in progress

Test passed.
```

Example 1-382 Testing the connection between the current AUSM card and the service equipment (CPE) using the channel number argument

```
s1.1.12.AUSM8.a > tstconseg 21
```

```
Output:  
tstcon in progress
```

```
Test passed.
```

tstdelay

Use the **tstdelay** command to conduct an external connectivity test by sending a single collection of supervisory cells to the remote end to the network and back. The terminal displays a pass or fail message and the round-trip time in milliseconds.

Full Name

Test Round Trip Delay

Card(s) on Which This Command Executes

PXM, FRSM, AUSM, CESH

Syntax: FRSM, CESH

tstdelay <channel number>

Syntax Description

channel number Channel number, in the range appropriate for the card.

- FRSM
 - 8T1/E1 range = 16–1015
 - HS1/B range = 16–1015
 - T3/E3/HS2 range = 16–2015
 - 2CT3 range = 16–4015
- CESH
 - 8T1/E1 range = 32–279
 - T3/E3, one connection starting at 32

Syntax: PXM

tstdelay <con_id>

Syntax Description

con_id Connection identifier, in the format *port.vpi.vci*.

- Port range = 1–*n*, as appropriate for the physical installation
- vpi range = 1–4095
- vci range = 1–65535

Syntax: AUSM-8T1E1

tstdelay <port.VPI.VCI | channel number>

Syntax Description

port.VPI.VCI Port range = 1–n, as appropriate for the physical installation.
VPI range = 1–4095.
VCI range = 1–65535.

channel number Channel number, in the range 16–1015.

Related Commands

dspcons, tstcon

Attributes

Log: No State: Active Privilege: 1–4

Example 1-383 Test the delay for a round trip to and from the network on channel 16

```
MGX 880061.1.10.AUSM.a > tstdelay 16

TestDelay in progress.
TestDelay Passed with 2 ms.
```

Example 1-384 Test the delay for a round trip to and from the network from the current AUSM card on port 2, VPI 1, VCI 1

```
s1.1.12.AUSM8.a > tstdelay 2.1.1
Output:
tstdelay in progress

Delay Test Passed with 2 ms.
```

Example 1-385 Test the delay for a round trip to and from the network from the current AUSM card on channel 21

```
s1.1.12.AUSM8.a > tstdelay 21

Output:
tstdelay in progress

Delay Test Passed with 1 ms.
```

uncnfifastrk

Use the PAR **uncnfifastrk** command to restore trunk routing operations on a PXM line.

Note Delete all trunk connections prior to using this command.

Full Name

Unconfigure Interface as Trunk

Card(s) on Which This Command Executes

PXM

Syntax

uncnfifastrk <slot,port> <iftype>

Syntax Description

- | | |
|------------------|---|
| <i>slot,port</i> | Slot and port number of the line to be designated for trunking. <ul style="list-style-type: none">• Slot = enter the value 7 (typical), or the slot where the PXM is installed.• Port = 1–n, as appropriate for the physical installation. |
| <i>iftype</i> | Type of trunk. <ul style="list-style-type: none">• frk = feeder trunk• rtrk = routing trunk (default) |

Related Commands

cnfifastrk

Attributes

Log: Yes State: Active Privilege: SuperUser

Example 1-386 Return the line on port 1 in slot 7 to use as a routing trunk

```
MGX-01.1.7.PXM.a > uncnfifastrk 7.1 rtrk
MGX-01.1.7.PXM.a >
```

An error message occurs if trunks are not deleted prior to invoking the **uncnfifastrk** command.

upif

Use the **upif** command to add a logical interface to a broadband port on a PXM. The purpose of configuring logical interfaces for a line is to create a structure for *resource partitioning*. The network control applications (PAR, Tag, and so on) require resources linked to the logical interfaces.

A PXM can have 1–32 logical interfaces regardless of the number of physical lines. With multiple lines serving as uplinks, you can divide the 32 logical interfaces between the active lines according to need, yet each line would still have the full range of VPIs and VCIs. In summary, the number of logical interfaces per line can vary, but the *maximum* number of VPIs and VCIs is fixed (with the actual range subject to your configuration). To change the configuration of an existing logical interface on the PXM, use the **cnfif** command.

Note On a virtual trunk, the *min_vpi* and *max_vpi* should be the same. Only a routing node can support virtual trunking.

Full Name

Up Interface

Card(s) on Which This Command Executes

PXM

Syntax

upif <if_num> <line_num> <pct_bw> <min_vpi> <max_vpi>

Syntax Description

<i>if_num</i>	Number of the logical interface, in the range 1–32.
<i>line_num</i>	PXM line number, in the range 1–4, 1 port on the OC-12 card, 4 ports on the OC-3 card, and 2 ports on the T3/E3 card.
<i>pct_bw</i>	Percentage of the line bandwidth to be allocated to the logical interface, in the range 0–100. The value applies to both the ingress and egress.
<i>min_vpi</i>	Minimum virtual path identifier value, in the range appropriate for either UNI or NNI. <ul style="list-style-type: none">• UNI = 0–255• NNI = 0–4095 The UNI range typically applies to a line connecting a stand-alone node to a workstation.
<i>max_vpi</i>	Maximum virtual path identifier value, in the range appropriate for either UNI or NNI. <ul style="list-style-type: none">• UNI = 0–255• NNI = 0–4095 Typically, the UNI range applies to a line connecting a stand-alone node to a workstation.

Related Commands

upif

Attributes

Log: No State: Active Privilege: 1–4

Example 1-387 The first “1” is the logical interface number; the second “1” is the line number on the PXM back card to which you are assigning this logical interface number; “100” is the percentage of bandwidth available to this logical interface in both directions; and the VPI range is 1–2000

```
spirit.1.7.PXM.a > upif 1 1 100 1 2000
spirit.1.7.PXM.a >
```

upport

Use the **upport** command to activate a specified AUSM port.

Full Name

Up port

Card(s) on Which This Command Executes

AUSM

Syntax

upport <*PortNum*>

Syntax Description

PortNum Port Number, in the range 1–8.

Related Commands

dnport

Attributes

Log: Yes State: Active Privilege: 1

users

Use the **users** command to view details associated with currently active users on the PXM. The screen display shows the means through which each user logged into the switch, the slot number of the current card, and the login name of the users.

Full Name

Display the names of all users currently logged in to the switch

Card(s) on Which This Command Executes

PXM

Syntax

users

Related Commands

None

Attributes

Log: No State: Any Privilege: Any

Example 1-388 Display the users logged into the switch

```
spirit.1.7.PXM.a > users
```

Port	Slot	Idle	UserId	From
telnet.01 *	7	0:00:00	cisco	171.71.25.240
telnet.02	3	0:07:03	cisco	171.71.25.240

```
spirit.1.7.PXM.a >
```

version

Use the **version** command to view different types of version-related information, such as firmware version, operating system kernel version, the date of the software build, and so on (refer to screen examples).

Full Name

Display Versions

Card(s) on Which This Command Executes

PXM, FRSM, AUSM, CESH, VISM

Syntax

version

Related Commands

None

Attributes

Log: No State: Any Privilege: Any

Examples

This section contains the following examples:

- Display version information on the current PXM card.
- Display version information on the current FRSM card.
- Display version information on the current VISM card.
- Display version information on the current AUSM card.

Example 1-389 Display version information on the current PXM card

```
spirit.1.7.PXM.a > version

VxWorks (for MGX 8850) version 5.3.1.
Kernel: WIND version 2.5.
Made on Feb 13 1999, 07:40:57.
Boot line:
lnPci(0,0) e=172.29.37.40 g=172.29.37.1
PXM firmware version : 1.0.00cpl
Boot Image Version   : 1.0.00av

spirit.1.7.PXM.a >
```

Example 1-390 Display version information on the current FRSM card

```
MGX 88003.1.11.FRSM.a > version

***** Cisco Systems, Inc. MGX 8800 FRSM Card *****
Firmware Version      = eqa2.0.1g
Backup Boot version   = model-B BT_2.0.0
PXMFRSM Xilinx file   = frsm025.h
VxWorks (for STRATACOM) version 5.1.1-R3000.
Kernel: WIND version 2.4.
Made on Wed Jan 13 19:45:10 PST 1999.
Boot line:

MGX 88003.1.11.FRSM.a >
```

Example 1-391 Display version information on the current VISM card

```
spirit.1.5.VISM8.a > version

***** Cisco Systems. AXIS VISM Card *****
Firmware Version      = rangar
Backup Boot version   = 3.2.02
Xilinx Firmware version = 10/ 2/1998
DSPCOM FPGA version   = 1/20/1999
DSPM Firmware Details:
  Major Release       = 3
  Minor Release       = 0
  Build number        = 12
DSPM ecan Firmware Details:
  Major Release       = 7
  Minor Release       = 3
  Build number        = 9e1
VxWorks (for R5k PDC) version 5.3.1.
Kernel: WIND version 2.5.
Made on Mar 9 1999, 14:19:21.
Boot line:

spirit.1.5.VISM8.a >
```

Example 1-392 Display version information on the current AUSM card

```
MGX 88003.1.14.AUSM.a > version

***** Cisco Systems, Inc. MGX 8800 AUSM Card *****
Firmware Version      = model-A 2.0.00
Backup Boot version   = model-A BT_eqa2.0.1
AUSM Xilinx file      = ausmfract.h
VxWorks (for STRATACOM) version 5.1.1-R3000.
Kernel: WIND version 2.4.
Made on Thu Jan 21 17:57:59 GMT 1999.
Boot line:

MGX 88003.1.14.AUSM.a >
```

who

Use the **who** command to view details associated with user IDs currently active on the PXM.

Full Name

Who

Card(s) on Which This Command Executes

PXM

Syntax

who

Related Commands

adduser, deluser, whoami

Attributes

Log: No

State: Any

Privilege: Any

Example 1-393 Display the users logged into the current card

```
spirit.1.7.PXM.a > who
```

Port	Slot	Idle	UserId	From
telnet.01 *	7	0:00:00	cisco	171.71.25.240

```
spirit.1.7.PXM.a >
```

whoami

Use the **whoami** command to view the current login ID, access level, and associated terminal port.

Full Name

Who Am I

Card(s) on Which This Command Executes

PXM

Syntax

whoami

Related Commands

adduser, deluser, who

Attributes

Log: No State: Any Privilege: Any

Example 1-394 Display information about the user of the current terminal session

```
spirit.1.7.PXM.a > whoami

User ID:      cisco
Access Level: CISCO_GP
Terminal Port: telnet.01

spirit.1.7.PXM.a >
```

xaddcon

Use the **xaddcon** command to add a connection to the current AUSM. No messages appear on screen after command entry unless the command cannot execute as entered.

Full Name

Add Connection

Card(s) on Which This Command Executes

AUSM

Syntax

xaddcon <channel number> <connection type> <port number> <vpi> <vci> <service type>
<egress queue number>

Syntax Description

<i>channel number</i>	Channel number, in the range 16–1015.
<i>connection type</i>	Value to set connection type as either VPP or VCC. <ul style="list-style-type: none"> • 1 = VPP • 2 = VCC
<i>port number</i>	Port number, in the range 1–8.
<i>vpi</i>	Virtual path identifier, in the range 0–255.
<i>vci</i>	Virtual channel identifier, in the range 0–65535.
<i>service type</i>	Value to set service type as either, CBR, VBR, or ABR. <ul style="list-style-type: none"> • 1 = CBR • 2 = VBR • 3 = ABR
<i>egress queue number</i>	Egress queue number, in the range 1–12. Zero (0) is for the default in addcon .

Related Commands

delcon, **dspcons**, **dspcon**

Attributes

Log: Yes State: Active Privilege: 1–2

Example 1-395 Add a VCC connection to channel 16 on port 1 with vpi=1, vci=1, ABR service type, and an egress queue number of 1

```
MGX 88003.1.14.AUSM.a > xaddcon 16 2 1 1 1 3 1
MGX 88003.1.14.AUSM.a >
```

A system response does not occur unless an error is detected.

xclrchanct

Use the **xclrchanct** command to clear the channel counters for a specified Frame Relay channel on a specified card. Counting resumes after the command executes.

Full Name

Clear Channel Counters

Card(s) on Which This Command Executes

PXM, FRSM, AUSM, CESH

Syntax: PXM

```
xclrchanct -cnt <chanNum> -cc <clrButton>
```

Syntax Description

-cnt	Command delineator that precedes the PXM <i>channel number</i> entry.
<i>chanNum</i>	PXM channel number, in the range 16–4111.
-cc	Command delineator that precedes the <i>cntClrButton</i> entry.
<i>clrButton</i>	Value to set the underline MIB object to clear or retain the counters. <ul style="list-style-type: none">• 1 = no action• 2 = clear counts

Syntax: FRSM, AUSM, CESH

```
xclrchanct -chn <channel number>
```

Syntax Description

- chn** Command delineator that precedes the *channel number* entry.
- channel number* Channel number in the range appropriate for the current card interface.
- FRSM
 - 8T1/E1 range = 16–1015
 - T3/E3/HS2 range = 16–2015
 - 2CT3 range = 16–4015
 - AUSM range = 16–1015
 - CESM
 - 8T1/E1 range = 32–279
 - T3/E3 = one connection starting at 32

Related Commands

dspchan, clrchancnts, dspchanct

Attribute

Log: No State: Any Privilege: 1–5

xclrportcnt

Use the **xclrportcnt** command to clear port counter values from the current AUSM or FRSM.

No message appears upon successful execution of the command.

Full Name

Clear Port Counters

Card(s) on Which This Command Executes

FRSM, AUSM

Syntax

xclrportcnt -pt <port number>

Syntax Description

-pt	Command delineator that precedes the <i>port number</i> entry.
<i>port number</i>	Port number, in the range appropriate for the current card. <ul style="list-style-type: none">• AUSM range = 1-8• FRSM range as appropriate for the interface.<ul style="list-style-type: none">— T1 range = 1-92— E1 range = 1-248

Related Commands

clrportcnts, xdspportent, xdspportent, dspportent

Attributes

Log: No State: Any Privilege: 1-5

xcnfalm

Use the **xcnfalm** command to configure extended alarm counters and statistics for the specified line.

Full Name

Configure Extended Alarm Counters and Statistics

Card(s) on Which This Command Executes

FRSM, AUSM, CESM

Syntax

```
xcnfalm -ds1 <LineNum> -red <RedSeverity> -rai <RAISeverity> -neu <NEAlarmUpcount> -ned  
<NEAlarmDncount> -net <NEAlarmThreshold> -feu <FEAlarmUpcount> -fed  
<FEAlarmDncount> -fet <FEAlarmThreshold>
```

Syntax Description

-ds1	Command delineator that precedes the <i>LineNum</i> entry.
<i>LineNum</i>	Line number, in the range 1– <i>n</i> , as appropriate for the current card.
-red	Command delineator that precedes the <i>RedSeverity</i> entry.
<i>RedSeverity</i>	Value that defines RedSeverity as either major or minor. <ul style="list-style-type: none"> • 1 = minor • 2 = major
-rai	Command delineator that precedes the <i>RAISeverity</i> entry.
<i>RAISeverity</i>	Value that defines RAISeverity as either major or minor. <ul style="list-style-type: none"> • 1 = minor • 2 = major
-neu	Command delineator that precedes the <i>NEAlarmUpcount</i> entry.
<i>NEAlarmUpcount</i>	NEAlarmUpcount, in the range 1–65335.
-ned	Command delineator that precedes the <i>NEAlarmDncount</i> entry.
<i>NEAlarmDncount</i>	NEAlarmDncount, in the range 1–65335.
-net	Command delineator that precedes the <i>NEAlarmThreshold</i> entry.
<i>NEAlarmThreshold</i>	NEAlarmThreshold, in the range 1–65335.
-feu	Command delineator that precedes the <i>FEAlarmUpcount</i> entry.
<i>FEAlarmUpcount</i>	FEAlarmUpcount, in the range 1–65335.
-fed	Command delineator that precedes the <i>FEAlarmDncount</i> entry.
<i>FEAlarmDncount</i>	FEAlarmThreshold, in the range 1–65335.
-fet	Command delineator that precedes the <i>FEAlarmThreshold</i> entry.
<i>FEAlarmThreshold</i>	FEAlarmThreshold, in the range 1–65335.

Related Commands

xcnfalmnt

Attributes

Log: Yes State: Active Privilege: 1

Example 1-396 To configure the ds1 line 1 alarms so that RED and RAI are both minor alarms, and the up and down counts and threshold for both FE and NE are all set to 100

```
MGX 88003.1.14.AUSM.a > xcnfalm -ds1 1 -red 1 -rai 1 -neu 100 -ned 100 -net 100 -feu
100 -fed 100 -fet 100
```

```
MGX 88003.1.14.AUSM.a >
```

xcnfalmcnt

Use the **xcnfalmcnt** command to configure the extended alarm counters for the specified line.

Full Name

Configure Alarm Counters

Card(s) on Which This Command Executes

AUSM, FRSM, CESM

Syntax

```
xcnfalmcnt -ds1 <LineNum> -sev <StatisticalAlarmSeverity> -lcv15 <ICV15minThreshold> -lcv24 <ICV24hrThreshold> -les15 <IES15minThreshold> -les24 <IES24hrThreshold> -lses15 <ISES15minThreshold> -lses24 <ISES24hrThreshold> -crc15 <cRC15MinThreshold> -crc24 <cRC24HrThreshold> -crcses15 <cRCSES15MinThreshold> -crcses24 <cRCSES24HrThreshold> -crcses15 <cRCSES15MinThreshold> -crcses24 <cRCSES24hrThreshold> -sefs15 <sEFS15minThreshold> -sefs24 <sEFS24hrThreshold> -aiss15 <aISS15minThreshold> -aiss24 <aISS24hrThreshold> -uas15 <uAS15minThreshold> -uas24 <uAS24hrThreshold>
```

Syntax Description

- ds1** Command delineator that precedes the *LineNum* entry.
LineNum
- sev** Command delineator that precedes the *StatisticalAlarmSeverity* entry.
StatisticalAlarmSeverity
- lcv15** Command delineator that precedes the *ICV15minThreshold* entry.
ICV15minThreshold
- lcv24** Command delineator that precedes the *ICV24hrThreshold* entry.
ICV24hrThreshold
- les15** Command delineator that precedes the *IES15minThreshold* entry.
IES15minThreshold
- les24** Command delineator that precedes the *IES24hrThreshold* entry.
IES24hrThreshold
- lses15** Command delineator that precedes the *ISES15minThreshold* entry.
ISES15minThreshold
- lses24** Command delineator that precedes the *ISES24hrThreshold* entry.
ISES24hrThreshold
- crc15** Command delineator that precedes the *cRC15MinThreshold* entry.
cRC15MinThreshold
- crc24** Command delineator that precedes the *cRC24HrThreshold* entry.

<i>cRC24HrThreshold</i>	
-crces15	Command delineator that precedes the <i>cRCES15MinThreshold</i> entry.
<i>cRCES15MinThreshold</i>	
-crces24	Command delineator that precedes the <i>cRCES24HrThreshold</i> entry.
<i>cRCES24HrThreshold</i>	
-crcses15	Command delineator that precedes the <i>cRCSES15MinThreshold</i> entry.
<i>cRCSES15MinThreshold</i>	
-crcses24	Command delineator that precedes the <i>cRCSES24hrThreshold</i> entry.
<i>cRCSES24hrThreshold</i>	
-sefs15	Command delineator that precedes the <i>sEFS15minThreshold</i> entry.
<i>sEFS15minThreshold</i>	
-sefs24	Command delineator that precedes the <i>sEFS24hrThreshold</i> entry.
<i>sEFS24hrThreshold</i>	
-aiss15	Command delineator that precedes the <i>aISS15minThreshold</i> entry.
<i>aISS15minThreshold</i>	
-aiss24	Command delineator that precedes the <i>aISS24hrThreshold</i> entry.
<i>aISS24hrThreshold</i>	
-uas15	Command delineator that precedes the <i>uAS15minThreshold</i> entry.
<i>uAS15minThreshold</i>	
-uas24	Command delineator that precedes the <i>uAS24hrThreshold</i> entry.
<i>uAS24hrThreshold</i>	

Related Commands

cnfalm, dspalment

Attributes

Log: Yes State: Active Privilege: 3

xcnfbert

Use the **xcnfbert** command to set up a Bit Error Rate Test (BERT) and to add or remove loops on the ports and lines of a specified SM.

A BERT test session does not time out automatically. Use the **delbert** command to conclude the test.

Note BERT is a disruptive test. Activation of this test will stop the data flow on all the channels configured on the port under test. BERT testing requires the presence of an SRM-3T3/B card in the service bay, in which the card under test is located.

Full Name

Configure Bit Error Rate Test

Card(s) on Which This Command Executes

PXM

Syntax

```
xcnfbert -bcntl <bertControl> -bsl <bertSlotNum> -bmed <bertTestMedium> -bpt <bertPort> -bline <bertLine> -bmode <bertMode> -bdtl <bertDeviceToLoop> -bcnt <bertDSODPIterationCount> -bpat <bertPattern> -blpbk <bertLoopback> -blpbkop <bertLoopbackOperation> -buid <bertUserId>
```

Syntax Description

-bcntl	Command delineator that precedes the <i>bertControl</i> entry.
<i>bertControl</i>	Value to set BERT control. <ul style="list-style-type: none"> • 1 = acquire • 2 = release • 3 = configure • 4 = start • 5 = modify • 6 = delete
-bsl	Command delineator that precedes the <i>bertSlotNum</i> entry.
<i>bertSlotNum</i>	BERT slot number, in the range 1-6, or 9-14, or 17-22, or 25-30.
-bmed	Command delineator that precedes the <i>bertTestMedium</i> entry.
<i>bertTestMedium</i>	Value to set either the port or the line as the test medium. <ul style="list-style-type: none"> • 1 = port • 2 = line
-bpt	Command delineator that precedes the <i>bertPort</i> entry.
<i>bertPort</i>	BERT port number, as a number greater than 0 (zero).

-bline	Command delineator that precedes the <i>bertLine</i> entry.
<i>bertLine</i>	BERT line number, as a number greater than 0 (zero).
-bmode	Command delineator that precedes the <i>bertMode</i> entry.
<i>bertMode</i>	Value to set BERT function as a patten test, DDS seek, or loopback. <ul style="list-style-type: none">• 1 = pattern test• 2 = DDS seek• 3 = loopback
-bdtl	Command delineator that precedes the <i>bertDeviceToLoop</i> entry.
<i>bertDeviceToLoop</i>	Value that defines the type of BERT device to loop. <ul style="list-style-type: none">• 1 = noLatchOCUwith1• 2 = noLatchOCUwithout1• 3 = noLatchCSU• 4 = noLatchDSU• 5 = latchDS0Drop• 6 = latchDS0Line• 7 = latchOCU• 8 = latchCSU• 9 = latchDSU• 10 = latchHL96• 11 = v54Polynomial• 12 = inband• 13 = esf• 14 = metallic• 15 = noDevice
-bent	Command delineator that precedes the <i>bertDS0DPIterationCount</i> entry.
<i>bertDS0DPIterationCount</i>	BERT DS0 DP iteration count, in the range 1-32.
-bpat	Command delineator that precedes the <i>bertPattern</i> entry.

<i>bertPattern</i>	Value to set the type of BERT test pattern to use. <ul style="list-style-type: none">• 1 = allZeros• 2 = allOnes• 3 = alternateOneZero• 4 = doubleOneZero• 5 = fifteenBit• 6 = twentyBit• 7 = twentyBitQRSS• 8 = twentyThreeBit• 9 = oneInEight• 10 = threeInTwentyFour• 11 = dds-1• 12 = dds-2• 13 = dds-3• 14 = dds-4• 15 = dds-5• 16 = nineBit• 17 = elevenBit
-blpbk	Command delineator that precedes the <i>bertLoopback</i> entry.
<i>bertLoopback</i>	Value that defines type of BERT loopback to use. <ul style="list-style-type: none">• 1 = farEndRemoteLoopback• 2 = portRemoteFacilityLoopback• 3 = metallicLoopback
-blpbkop	Command delineator that precedes the <i>bertLoopbackOperation</i> entry.
<i>bertLoopbackOperation</i>	Value that defines the BERT loopback as either loop up or loop down. <ul style="list-style-type: none">• 1 = loopUp• 2 = loopDown
-buid	Command delineator that precedes the <i>bertUserId</i> entry.
<i>bertUserId</i>	BERT user identifier. <ul style="list-style-type: none">• User name =• IP address = 32 bit IP address in dotted decimal format.

Related Commands

delbert

Attributes

Log: Yes

State: Active

Privilege: SUPER_GP

xcnfdsx3bert

Use the **xcnfdsx3bert** command to specify a pattern for BERT testing on the FRSM.

Full Name

Configure DS3 BERT

Card(s) on Which This Command Executes

FRSM 2T3E3

Syntax

xcnfdsx3bert -dsx3bct <state> -dsx3btm <medium> -dsx3bln <line num> -dsx3bmo <mode> -ds3bei
<EIR> -ds3bpt <test pattern>

Syntax Description

-dsx3bet	Command delineator that precedes the <i>state</i> entry.
<i>state</i>	Value to define type of DSX3 BERT control. <ul style="list-style-type: none"> • 1 = acquire BERT • 2 = Release BERT • 3 = Configure BERT • 4 = Start BERT • 5 = Modify BERT • 6 = Delete BERT
-dsx3btm	Command delineator that precedes the <i>medium</i> entry.
<i>medium</i>	Value to define DSX3 BERT Testing medium. <ul style="list-style-type: none"> • 1 = Port • 2 = Line
-dsx3bln	Command delineator that precedes the <i>line num</i> entry.
<i>line num</i>	Line number, in the range 1–2.
-dsx3bmo	Command delineator that precedes the <i>mode</i> entry.
<i>mode</i>	Value to define BERT mode as pattern or loopback. <ul style="list-style-type: none"> • 1 = pattern • 2 = loopback
-ds3bei	Command delineator that precedes the <i>EIR</i> entry.
<i>EIR</i>	Value to define the DSX3 Excess Information Rate. <ul style="list-style-type: none"> • 1 = no error • 2 = 1 in 10 • 3 = 1 in 100 • 4 = 1 in 1000 • 5 = 1 in 10⁴ • 6 = 1 in 10⁵ • 7 = 1 in 10⁶ • 8 = 1 in 10⁷
-ds3bpt	Command delineator that precedes the <i>test pattern</i> entry.
<i>test pattern</i>	DSX3 BERT pattern, in the range 1–33.

Related Commands

xdspdsx3bert

Attributes

Log: No

State: Active

Privilege: Any

xcnfif

Use the **xcnfif** command to modify parameters for an existing broadband interface on a PXM. System software does not allow you to conflict with existing configurations. You may need to reduce the bandwidth allocation or VPI/VCI range on one or more interfaces before you expand the resources for a interface. Refer to the **upif** command description for more information on resource partitioning.

Full Name

Configure a Broadband Interface

Card(s) on Which This Command Executes

PXM

Syntax

```
xcnfif -if <bbIfNum> -bl <lineNum> -ie <rowStatus> -ib <ingrPctBw> -eb <egrPctBw> -iv  
<minVpi> -av <maxVpi>
```

Syntax Description

-if	Command delineator that precedes the <i>bbIfNum</i> entry.
<i>bbIfNum</i>	Number of the logical interface, in the range 1–32.
-bl	Command delineator that precedes the <i>lineNum</i> entry.
<i>lineNum</i>	Number of the line to tie the logical interface to, in the range 1–4.
-ie	Command delineator that precedes the <i>rowStatus</i> entry.
<i>rowStatus</i>	Value to enable, disable, or modify the row status. <ul style="list-style-type: none"> • 1 = enable • 2 = disable • 3 = modify
-ib	Command delineator that precedes the <i>ingrPctBw</i> entry.
<i>ingrPctBw</i>	Percentage of interface bandwidth to be allocated to ingress traffic, in the range 0–100.
-eb	Command delineator that precedes the <i>egrPctBw</i> entry.
<i>egrPctBw</i>	Percentage of line egress queue bandwidth to be allocated for the logical interface, in the range 0–100.
-iv	Command delineator that precedes the <i>minVpi</i> entry.
<i>minVpi</i>	Minimum virtual path identifier value, in the range 0–4095.
-av	Command delineator that precedes the <i>maxVpi</i> entry.
<i>maxVpi</i>	Maximum virtual path identifier value, in the range 0–4095.

Related Commands

upif

Attributes

Log: No: Yes State: Any

Privilege: CISCO_GP

Examples

This section contains the following examples.

- Configure and enable a specific broadband interface to use a specified percentage of the line bandwidth for both ingress and egress traffic, and set VPI for minimum 0 and maximum 19.
- Verify the broadband configuration on the PXM.

Example 1-397 Configure and enable broadband interface number 1 on line 4 to use 10% of the line bandwidth for both ingress and egress, have a minimum virtual path interface (VPI) of 0, and a maximum virtual path interface (VPI) of 19

```
wilco.1.7.PXM.a > xcnfif -if 1 -bl 4 -ie 1 -ib 10 -eb 10 -iv 0 -av 19
wilco.1.7.PXM.a >
```

A system response does not occur unless an error is detected. To verify your entries, use the **dspif** command.

Example 1-398 Verify broadband configuration on the PXM

```
wilco.1.7.PXM.a > dspif

ifNum  Status  Line  ingrPctBw  egrPctBw  minVpi  maxVpi
-----
1      Ena      1      10         10         0       19

wilco.1.7.PXM.a >
```

xcnfifip

Use the **xcnfifip** command to set the IP address for the LAN, Slip, and ATM interfaces.

Full Name

Configure Interface for IP

Card(s) on Which This Command Executes

PXM

Syntax:

xcnfifip -ifn <Interface> -ipa <ip_addr> -msk <NetMask> -bc <Brocast addr> -ipo <Oper>

Syntax Description

-ifn	Command delineator that precedes the <i>Interface</i> entry.
<i>Interface</i>	Value that defines interface type. <ul style="list-style-type: none">• 26 = Ethernet• 28 = SLIP• 37 = ATM
-ipa	Command delineator that precedes the <i>ip_addr</i> entry.
<i>ip_addr</i>	IP address in dotted decimal format.
-msk	Command delineator that precedes the <i>NetMask</i> entry.
<i>NetMask</i>	NetMask = <i>nnn.nnn.nnn.nnn</i> , <i>n</i> = 0-9, <i>nnn</i> < 256
-bc	Command delineator that precedes the <i>Brocast Addr</i> entry.
<i>Brocast Addr</i>	Broadcast Address = <i>nnnnnnnn</i> , <i>n</i> is hexadecimal, Ethernet only.
-ipo	Command delineator that precedes the <i>Oper</i> entry.
<i>Oper</i>	Value to enable or disable IP Address. <ul style="list-style-type: none">• 1 = Add• 2 = Delete

Attributes

Log: Yes State: Any Privilege: SUPER_GP

Examples

This section contains the following examples:

- Configure and enable an Ethernet interface to use a specified IP address, netmask, and broadcast address.
- Verify the configuration.

Example 1-399 Configure and enable the Ethernet interface to use the IP address 172.29.37.40, the netmask 255.255.255.000, and the broadcast address 255.255.255.000

```
spirit4.1.7.PXM.a > xcnfifip -if 26 -ipa 172.29.37.40 -msk 255.255.255.000 -bc
255.255.255.000 -ipo 1
spirit4.1.7.PXM.a >
```

A system response does not occur unless an error is detected. To verify your entries, use the **dspifip** command.

Example 1-400 Verify the IP Address configuration

```
spirit4.1.7.PXM.a > dspifip
```

Interface	IPAddress	NetMask	BroadcastAddress
Ethernet	172.29.37.40	255.255.255.000	255.255.255.000
Slip	192.169.3.18	255.255.255.000	
ATM		255.255.255.000	

```
spirit4.1.7.PXM.a >
```

xcnfilmi

Use the **xcnfilmi** command to configure local management interface for a port. No messages appear on screen unless an error occurs.

Full Name

Configure ILMI

Card(s) on Which This Command Executes

AUSM

Syntax

```
xcnfilmi -pti <port_num> -s <signal_type> -vpi <virtual_path_identfier> -vci  
<virtual_channel_identfier> -t <trap_enable> -mti <min_trap_int> -kap <keep_alive> -eth  
<ErrorThreshold> -evh <EventThreshold> -pi <PollingInterval> -mei <MinimumEnquiryInterval>  
-ar <AddrRegEnable>
```

Syntax Description

-pti	Command delineator that precedes the <i>port_num</i> entry.
<i>port_num</i>	Port number, in the range 1–8.
-s	Command delineator that precedes the <i>signal_type</i> entry.
<i>signal_type</i>	Value that defines signaling type. <ul style="list-style-type: none"> • 1 = other • 2 = no signaling • 3 = ILMI
-vpi	Command delineator that precedes the <i>virtual_path_id</i> entry.
<i>virtual_path_id</i>	Virtual path identifier, in the range 1–255.
-vci	Command delineator that precedes the <i>virtual_channel_id</i> entry.
<i>virtual_channel_id</i>	Virtual channel identifier, in the range 1–65535.
-t	Command delineator that precedes the <i>trap_enable</i> entry.
<i>trap_enable</i>	Value that enables or disable ILMI traps. <ul style="list-style-type: none"> • 1 = disable • 2 = enable
-mti	Command delineator that precedes the <i>min_trap_int</i> entry.
<i>min_trap_int</i>	Minimum trap interval value, in the range 1–10 seconds.
-kap	Command delineator that precedes the <i>keep_alive</i> entry.
<i>keep_alive</i>	Value that enables or disables Keep Alive Polling. <ul style="list-style-type: none"> • 1 = disable • 2 = enable
-eth	Command delineator that precedes the <i>ErrorThreshold</i> entry.
<i>ErrorThreshold</i>	Error Threshold, in the range 1–10 seconds.
-evh	Command delineator that precedes the <i>EventThreshold</i> entry.
<i>EventThreshold</i>	Event Threshold, in the range 1–10 seconds.
-pi	Command delineator that precedes the <i>PollingInterval</i> entry.
<i>PollingInterval</i>	Polling interval, in the range 5–60 seconds.
-mei	Command delineator that precedes the <i>MinimumEnquiryInterval</i> entry.
<i>MinimumEnquiryInterval</i>	Minimum enquiry interval, in the range 1–20 seconds.
-ar	Command delineator that precedes the <i>AddrRegEnable</i> entry.
<i>AddrRegEnable</i>	Value that enables or disables Address Registration. <ul style="list-style-type: none"> • 1 = disable • 2 = enable

Related Commands

xdspilmi, dspilmi, dspilmicnt

Attributes

Log: Yes

State: Active

Privilege: 1

xcnfln

Use the **xcnfln** command to configure a line on the current card to be either T1 or E1. If the command line does not include the E1 signalling parameter, the line is a T1.

For an FRSM-HS1 card, the **xcnfln** command is used to configure either an X.21 or a V.35 line.

Full Name

Configure Line

Card(s) on Which This Command Executes

FRSM, AUSM, CESM

Syntax

xcnfln <line_num> <line_code> <line_len> <clk_src> [E1-signaling]

Syntax Description

<i>line_num</i>	Line number, in the range 1–8.
<i>line_code</i>	Value to set Line coding. <ul style="list-style-type: none"> • 2 = B8ZS • 3 = HDB3 • 4 = AMI
<i>line_len</i>	Value to set Line length for either T1 or E1. <ul style="list-style-type: none"> • T1 range = 1–7 • E1 range = 8–9
<i>clk_src</i>	Value to set clock source for either loop clock or local clock. <ul style="list-style-type: none"> • 1 = loop clock • 2 = local clock
<i>E1-signalling</i>	<ul style="list-style-type: none"> • N CRC: type CAS = CAS • CAS with CRC: type CAS_CRC • CCS = CCS no CRC • CCS_CRC = CCS with CRC • CLEAR = Clear E1

Syntax for FRSM-HS1

xcnfln xcnfln *-hs1* <LineNum> *-e* <Enable> *-lt* <LineType> *-sp* <LineRate> *-lpb* <LoopCmd>
-sc <SendCode> *-detect* <LoopbackCodeDetection> *-clktype* <InvertClock>

Syntax Description

<i>LineNum</i>	Line number, in the range 1–4.
<i>Enable</i>	Line coding value from 1 to 3. <ul style="list-style-type: none"> • 1 = disable • 2 = enable • 3 = mod
<i>lineType</i>	LineType, in the range 1 to 3. <ul style="list-style-type: none"> • 1 = DTE • 2 = DCE • 3 = DTE_ST (in V.35 only)
<i>LineRate</i>	The rate in bits/sec.
<i>LoopCmd</i>	A value, either 1, 4 or 5. <ul style="list-style-type: none"> 1 = no loop (X.21, V.35) 4 = remote (X.21) 5 = metallic (X.21, V.35)
<i>SendCode</i>	A value, either 1, 4, 5 or 6. <ul style="list-style-type: none"> • 1 = no code • 4 = local loop • 5 = remote loop • 6 = unloop
<i>LoopbackCodeDetection</i>	A value, either 1 or 2. <ul style="list-style-type: none"> • 1 = disable • 2 = enable
<i>InvertClock</i>	A value, either 1 or 2. <ul style="list-style-type: none"> • 1 = normal • 2 = inverted

Related Commands

cnfln, addln, delln

Attributes

Log: Yes State: Active Privilege: 1

Example 1-401 Configure line 4 to be T1 with B8ZS line coding, have a length of 1, and use the loop clock as a clock source

```
MGX 88003.1.11.FRSM.a > xcnfln 4 2 1 1  
MGX 88003.1.11.FRSM.a >
```

Example 1-402 Configure line 1 for remote loopback and send codes for remote loop on the current FRSM card

```
man.1.4.FRSM.a > xcnfln -hs1 1 -e 3 -lpb 4 -sc 5
```

xcnfport

Use the **xcnfport** command to configure a service port on an FRSM or an AUSM.

The screen does not display a message after successful command entry. The configuration can be verified using the **xdspport** or **dspport** command.

The syntax for this command differs according to the service module being addressed.

Card(s) on Which This Command Executes

FRSM, AUSM

Full Name

Configure Port

Syntax: FRSM

xcnfport <port_num> <PortLineNum> <PortEnable> <lmi_sig> <asyn> <T391> <T392> <N391>
<N392> <N393> <CLLMEN> <CLLMTM>

Syntax Description

<i>port_num</i>	Port number, in the range appropriate for the card. <ul style="list-style-type: none">• FRSM T1: 1–192• FRSM E1: 1–248
PortLineNum	Line number in the range 1–8.
<i>lmi_sig</i>	Value that defines type of LMI signaling to be used on the card. <ul style="list-style-type: none">• 1 = Other• 2 = None• 3 = StrataLMI• 4 = AnnexAUNI• 5 = AnnexDUNI• 6 = AnnexANNI• 7 = AnnexDNNI
<i>asyn</i>	Asyn update is (y)es or (n)o
<i>T391</i>	T391 timer value, in the range 5–30 sec.
<i>T392</i>	T392 timer value, in the range 5–30 sec.
<i>N391</i>	N391 counter value, in the range 1–255.
<i>N392</i>	N392 counter value, in the range 1–10.
<i>N393</i>	N393 counter value, in the range 1–10.
<i>CLLMEN</i>	Value to enable or disable Consolidated Link Management. <ul style="list-style-type: none">• 1 = disable• 2 = enable
<i>CLLMTM</i>	Consolidated Link Management Timer value, in the range 40–5000 ms.

Possible errors are

- illegal/invalid parameters
- port doesn't exist, use **addport** command to add port first
- LMI NNI not enabled

Related Commands

xcnfport, addport, delpport, dspport, dsports, xdsport, xdsports

Attributes

Log: Yes State: Active Privilege: 1–6

Syntax: AUSM

xcnfport <port_num> <plpp loopback>

Syntax Description

port_num Port number, in the range 1–8.

plpp loopback Value to set type of Physical Layer Protocol Processor loopback.

- 1 = no loopback
- 2 = remote loopback
- 3 = local loopback

Related Commands

cnfport, addport, delport, dspport, dspports, xdspport, xdspports

Attributes

Log: Yes State: Active Privilege: 1

System Response

A system response does not occur unless an error is detected.

xcnfportq

Use the **xcnfportq** command to configure queue parameters on a port associated with the current AUSM.

A system response does not occur unless an error is detected.

Full Name

Configure Port Queue

Card(s) on Which This Command Executes

AUSM

Syntax

```
xcnfportq -pt <ServicePortNum> -pqn <PortQNumber> -e <Enable> -sn <SequenceNo> -qdm
<QueueDepthMax> -clph <EgressQCLPThreshHigh> -clpl <EgressQCLPThresLow> -clpt
<EgressQEFCTHresh> -qa <EgressQAlgorithm> -mxbi <EgressMaxBandwidthInc> -mibi
<MinimumBandwidthInc>
```

Syntax Description

-pt	Command delineator that precedes the <i>ServicePortNum</i> entry.
ServicePortNum	Port number, in the range 1–8.
-pqn	Command delineator that precedes the <i>PortQNumber</i> entry.
PortQNumber	Queue number, in the range 1–16.
-e	Command delineator that precedes the <i>Enable</i> entry.
Enable	Value to enable or disable the queue. <ul style="list-style-type: none"> • 1 = enable • 2 = disable
-sn	Command delineator that precedes the <i>SequenceNo</i> entry.
SequenceNo	Service sequence number, in the range 1–16.
-qdm	Command delineator that precedes the <i>QueueDepthMax</i> entry.
QueueDepthMax	Size of the queue. Set number of cells allowable in the queue, in the range 1–16000.
-clph	Command delineator that precedes the <i>EgressQCLPThresHigh</i> entry.
EgressQCLPThresHigh	Cell Loss Priority high-threshold value for traffic exiting the physical interface of the AUSM, in the range 1–16000.
-clpl	Command delineator that precedes the <i>EgressQCLPThresLow</i> entry.
EgressQCLPThresLow	Cell Loss Priority low-threshold value, in the range 1–16000. <p>Once the low Cell Loss Priority threshold is passed, cells will no longer have the CLP bit set, making them eligible for discard.</p>

-clpt	Command delineator that precedes the <i>EgressQEFCThresh</i> entry.
EgressQEFCThresh	Explicit Forward Congestion Indicator threshold value, in the range 1–16000. An Explicit Forward Congestion Indicator is sent to the sending node when the threshold is exceeded.
-qa	Command delineator that precedes the <i>EgressQAlgorithm</i> entry.
EgressQAlgorithm	Queue algorithm, in the range 1–5. To disable the queue, set value at 0 (zero).
-mxbi	Command delineator that precedes the <i>EgressMaxBandwidthInc</i> entry.
EgressMaxBandwidthInc	Egress Maximum Bandwidth Increment value, in the range 0–4096. An Explicit Forward Congestion Indicator is sent to the sending node when the threshold is exceeded.
-mibi	Command delineator that precedes the <i>MinimumBandwidthInc</i> entry.
<i>MinimumBandwidthInc</i>	Minimum Bandwidth Increment value, in the range 0–4096.

Related Commands

cnfportq, xcnfportqs

Attributes

Log: Yes

State: Active

Privilege: 1–6

Example 1-403

```
spirit3.1.22.AUSM8.a > xcnfportq -pt 1  
spirit3.1.22.AUSM8.a >
```

xcnfred

Use the **xcnfred** command to set redundancy between two PXM slots, and to set the primary and secondary PXMs in the pair. Redundancy can be 1:1 or 1:*n*. If the redundancy is 1:*n*, repeat the **xcnfred** command for each secondary slot to be linked to the primary slot.

Full Name

Configure Redundancy

Card(s) on Which This Command Executes

PXM

Syntax

```
xcnfred -pri <redPrimarySlotNum> -en <rowStatus> -sec <redSecondarySlotNum> -type <redType>
```

Syntax Description

-pri	Command delineator that precedes the <i>redPrimarySlotNum</i> entry.
<i>redPrimarySlotNum</i>	Slot number that contains the primary card of the card pair. Ranges = 1–6, 9–14, 17–22, and 25–30.
-en	Command delineator that precedes the <i>rowStatus</i> entry.
<i>rowStatus</i>	Value to enable, disable, or modify the row status. <ul style="list-style-type: none"> • 1 = enable • 2 = disable • 3 = modify
-sec	Command delineator that precedes the <i>redSecondarySlotNum</i> entry.
<i>redSecondarySlotNum</i>	Slot number that contains the secondary card of the card pair. Ranges = 1–6, 9–14, 17–22, and 25–30.
-type	Command delineator that precedes the <i>redType</i> entry.
<i>redType</i>	Value that defines type of redundancy to be used. <ul style="list-style-type: none"> • 1 = 1:1 • 2 = 1:<i>n</i>

Related Commands

dspre, **delred**

Attributes

Log: No

State: Active

Privilege: Any

Example 1-404 Add 1:1 redundancy between the card in slot 4 and the card in slot 1

```
node501.1.7.PXM.a > xcnfred -pri 1 -en 1 -ser 4 -type 1
node501.1.7.PXM.a >
```

xcnfrscprtn

Use the **xcnfrscprtn** command to partition PXM resources (bandwidth) as broadband interfaces.

Full Name

Configure Resource Partition Extended Parameters

Card(s) on Which This Command Executes

PXM

Syntax

```
xcnfrscprtn -pn <bbIfNum> -cn <ctrlrNum> -pr <rowStatus> -ps <inUse> -pi <ingrPctBw> -pe  
<egrPctBw> -pv <minVpi> -pu <maxVpi> -pc <minVci> -pd <maxVci> -pch <maxGLCNs>
```

Syntax Description

-pn	Command delineator that precedes the <i>bbIfNum</i> entry.
<i>bbIfNum</i>	Broadband interface number, in the range 1-32.
-cn	Command delineator that precedes the <i>ctrlrNum</i> entry.
<i>ctrlrNum</i>	Value that represents the type of controller to be used on the interface. <ul style="list-style-type: none">• 1 = PAR• 2 = PNNI• 3 = TAG
-pr	Command delineator that precedes the <i>rowStatus</i> entry.
<i>rowStatus</i>	Value to enable, disable, or modify the row status. <ul style="list-style-type: none">• 1 = enable• 2 = disable• 3 = modify
-ps	Command delineator that precedes the <i>inUse</i> entry.
<i>inUse</i>	Value to set operational status of the interface. <ul style="list-style-type: none">• 1 = In Use• 2 = Not In Use
-pi	Command delineator that precedes the <i>ingrPctBw</i> entry.
<i>ingrPctBw</i>	Percentage of interface bandwidth to be allocated to ingress traffic, in the range 0-100.
-pe	Command delineator that precedes the <i>egrPctBw</i> entry.
<i>egrPctBw</i>	Percentage of interface bandwidth to be allocated to egress traffic, in the range 0-100.
-pv	Command delineator that precedes the <i>minVpi</i> entry.
<i>minVpi</i>	Minimum Virtual Path Indicator value, in the range 0-4095.
-pu	Command delineator that precedes the <i>maxVpi</i> entry.
<i>maxVpi</i>	Maximum Virtual Path Indicator value. Enter a value that is greater than that defined for <i>bbIfRscPrtVpiLow</i> and less than 4095.
-pc	Command delineator that precedes the <i>minVci</i> entry.
<i>minVci</i>	Minimum Virtual Channel Indicator value, in the range 0-65535.
-pn	Command delineator that precedes the <i>maxVci</i> entry.
<i>maxVci</i>	Maximum Virtual Channel Indicator, in the range 0-65535.
-pch	Command delineator that precedes the <i>maxGLCNs</i> entry.
<i>maxGLCNs</i>	Maximum Global Logical Connection Number value, in the range 0-32767.

Attributes

Log: Yes State: Any Privilege: Cisco

Example 1-405 Configure and enable a resource partition

```
spirit4.1.1.7.PXM.a > xcnfrscprtn -pn 1 -cn 1 -pr 1 -ps 1 -pi 100 -pe 100 -pi 0 -pu 4095  
-pc 0 -pd 65535 -pth 32767
```

```
spirit4.1.1.7.PXM.a >
```

xcnfsrmlink

Use the **xcnfsrmlink** command to configure and to enable a link between a T1 line within a T3 line on an SRM-3T3 card and a slot and line number on a T1 service module.

Full Name

Configure Link

Card(s) on Which This Command Executes

PXM

Syntax

```
xcnfsrmlink -srmt3 <T3 line number> -srmt1 <T1 line number> -en <rowStatus> -srms1 <Target Slot number> -srmln <Slot line number>
```

Syntax Description

-srmt3	Command delineator that precedes the <i>T3 line number</i> entry.
<i>T3 line number</i>	SRM-3T3 T3 line number in the format <i>slot.line</i> . <ul style="list-style-type: none"> <i>slot</i> = enter value either 15 or 31 <p>Slot number 15 is used for the cards in slot and 15 and 16 (whichever is active). Slot 31 is used for cards in 31 and 32.</p> <i>line</i> range = 1–3
-srmt1	Command delineator that precedes the <i>T1 line number</i> entry.
<i>T1 line number</i>	T1 line number, in the range 1–28.
-en	Command delineator that precedes the <i>rowStatus</i> entry.
<i>rowStatus</i>	Value to enable, disable, or modify the row status. <ul style="list-style-type: none"> 1 = enable 2 = disable 3 = modify
-srms1	Command delineator that precedes the <i>Target Slot number</i> entry.
<i>Target Slot number</i>	Number of the T1 service module slot to be linked. <i>Target Slot number</i> ranges = 1-6 9-14 17-22 25-30
-srmln	Command delineator that precedes the <i>Slot line number</i> entry.
<i>Slot line number</i>	T1 line number in the slot to be linked (range 1–4 or 1–8) as appropriate for the installed service module.

Related Commands

addlink, dsplink, dellink, xdpsrmlink

Attributes

Log: Yes State: Active Privilege: SuperUser

Example 1-406 Configure and enable a link between the T1 line 1 within T3 line 2 on the SRM-3T3 card in slot 15 and T1 line number 5 on the T1 service module in slot 3

```
spirit4.1.7.PXM.a > xcnfsrmlink -srmt3 15.2 -srmt1 1 -en 1 -srmsl 3 -srmln 5
spirit4.1.7.PXM.a >
```

xcnftrapmgr

Use the **xcnftrapmgr** command to configure, enable, and to disable the trap manager function on the PXM. If you enable the trap manager, this command allows you configure the number and IP address of the trap manager you intend to receive traps.

Full Name

Configure Trap Manager

Card(s) on Which This Command Executes

PXM

Syntax

xcnftrapmgr -ip <ip_addr> -pt <portnum> -en <enabled> -tf <TrapFlag> -seq <SeqNum>

Syntax Description

-ip	Command delineator that precedes the <i>ip_addr</i> entry.
<i>ip_addr</i>	IP address of the trap manager in dotted decimal format <i>nnn.nnn.nnn.nnn</i> .
-pt	Command delineator that precedes the <i>portnum</i> entry.
<i>portnum</i>	Port number, in the range 1– <i>n</i> , as appropriate for the card.
-en	Command delineator that precedes the <i>enabled</i> entry.
<i>enabled</i>	Value that enables or disables the flag action on the row. <ul style="list-style-type: none"> • 1 = add row • 2 = delete row
-tf	Command delineator that precedes the <i>TrapFlag</i> entry.
TrapFlag	Trap flag entry.
-seq	Command delineator that precedes the <i>SeqNum</i> entry.
<i>SeqNum</i>	Sequence number entry.

Related Commands

None

Attributes

Log: Yes State: Active Privilege: SuperUser

Example 1-407

```
spirit4.1.8.PXM.a > xcnftrapmgr -ip 192.169.3.102 -pt 3 -tf 1 -seq 100 -en 1
spirit4.1.8.PXM.a >
```

xdelcon

Use the **xdelcon** command to remove a connection on an AUSM. A system response does not occur unless an error is detected.

Full Name

Delete a Connection

Card(s) on Which This Command Executes

AUSM

Syntax

xdelcon <connection number>

Syntax Description

connection number Connection number, in the range 16–1015.

Related Commands

delcon, xdspcon, dspcon, xdspcons, dspcons, xaddcon, addcon

Attributes

Log: Yes

State: Active

Privilege: 1–2

xdnport

Use the **xdnport** command to deactivate a port. A system response does not occur unless an error is detected.

Full Name

Down Port

Card(s) on Which This Command Executes

AUSM

Syntax

xdnport -pt <PortNum> -e <PortEnable> -ptyp <PortType> -ln <LineNum>

Syntax Description

-pt	Command delineator that precedes the <i>PortNum</i> entry.
<i>PortNum</i>	Port number, in the range 1–8.
-e	Command delineator that precedes the <i>PortEnable</i> entry.
<i>PortEnable</i>	Value that enables or disables the port. <ul style="list-style-type: none">• 1 = disable• 2 = enable
-ptyp	Command delineator that precedes the <i>PortType</i> entry.
<i>PortType</i>	Value that represents either NNI or UNI port type. <ul style="list-style-type: none">• 1 = NNI• 2 = UNI
-ln	Command delineator that precedes the <i>PhysLineNum</i> entry.
<i>PhysLineNum</i>	Physical line number, in the range 1–8.

Related Commands

xupport

Attributes

Log: No State: Active Privilege: 1

xdspchan

Use the **xdspchan** command to view a channel on the current service card.

Full Name

Display Channel

Card(s) on Which This Command Executes

FRSM, AUSM, CESM

Syntax

xdspchan -chn <*ChanNum*>

Syntax Description

-chn	Command delineator that precedes the <i>ChanNum</i> entry.
<i>ChanNum</i>	Channel number, using the range appropriate for the current card. <ul style="list-style-type: none">• FRSM<ul style="list-style-type: none">— 8T1/E1 range = 16–1015— T3/E3/HS2 range = 16–2015— 2CT3 range = 16–4015• AUSM range = 16–1015• CESM<ul style="list-style-type: none">— 8T1/E1 range = 32–279— T3/E3 = one connection starting at 32

Related Commands

xdspchans, dspchans, xcnfchan, cnfchan

Attributes

Log: No State: Any Privilege: 1–6

Examples

This section contains the following examples.

- Display the channel characteristics of channel 22 on the FRSM card in slot 20.
- Display the channel characteristics of channel 33 on the CESM card in slot 22.

Example 1-409 Display the channel characteristics of channel 33 on the CESM card in slot 22

```
spirit3.1.21.CESM.a > xdspchan 33

ChanNum:                33
ChanRowStatus:          Add
ChanLineNum:            1
ChanMapVpi:             5
ChanMapVci:             33
ChanCBRService:         structured
ChanClockMode:          Synchronous
ChanCAS:                 Basic
ChanPartialFill:        47
ChanMaxBufSize:         124 bytes
ChanCDVT:               1000 micro seconds
C L I P:                2500 milliseconds
ChanLocalRemoteLpbkState: Disabled
ChanTestType:           TestOff
ChanTestState:          NotInProgress
ChanRTDresult:          65535 ms
ChanPortNum             2
ChanConnType            PVC
ISDetType               DetectionDisabled
CondData                255
CondSignalling          0
ExtISTrig               DisableIdleSupression
ISIntgnPeriod           4095 seconds
ISSignallingCode        0
OnHookCode              1
ChanLocalVpi:           0
ChanLocalVci:           0
ChanLocalNSAP:          504f504559453300000000000000000000015000200
ChanRemoteVpi:          0
ChanRemoteVci:          0
ChanRemoteNSAP:         NULL NSAP
ChanMastership:         Slave
ChanVpcFlag:            Vcc
ChanConnServiceType:    CBR
ChanRoutingPriority:    1
ChanMaxCost:            255
ChanRestrictTrunkType:  No Restriction
ChanConnPCR:            688
ChanConnMCR:            688
ChanConnPercentUtil:    100
ChanNum:                41
ChanRowStatus:          Mod
ChanLineNum:            3
ChanMapVpi:             5
ChanMapVci:             41
ChanCBRService:         unstructured
ChanClockMode:          Synchronous
ChanCAS:                 Basic
ChanPartialFill:        47
ChanMaxBufSize:         7680 bytes
ChanCDVT:               20000 micro seconds
C L I P:                30000 milliseconds
ChanLocalRemoteLpbkState: Disabled
ChanTestType:           TestOff
ChanTestState:          Failed
ChanRTDresult:          65535 ms
ChanPortNum             10
ChanConnType            PVC
ISDetType               DetectionDisabled
CondData                255
CondSignalling          8
```

xdspchancnt

Use the **xdspchancnt** command to view the counter contents of all channels (or the specified channel with the optional **-chn** parameter).

Full Name

Display Channel Count

Card(s) on Which This Command Executes

PXM, FRSM, AUSM, CESH

Syntax

xdspchancnt **-chn** <ChanNum>

Syntax Description

-chn Command delineator that precedes the *ChanNum* entry.

ChanNum Channel number, using the range appropriate for the current card.

- FRSM
 - 8T1/E1 range = 16–1015
 - T3/E3/HS2 range = 16–2015
 - 2CT3 range = 16–4015
- PXM range = 16–4111
- AUSM range = 16–1015
- CESH
 - 8T1/E1 range = 32–279
 - T3/E3 = one connection starting at 32

Related Commands

dspchancnt, **xdspchstats**, **dspchstats**

Attributes

Log: No State: Any Privilege: 1–6

Examples

This section contains the following examples:

- Display the channel counters of all the channels on the FRSM card in slot 20.
- Display the channel counters of channel 17 on the PXM card in slot 7.
- Display the channel counters of all the channels on the CESM card in slot 21.
- Display the channel counters of channel 33 on the CESM card in slot 21.
- Display the channel counters of channel 22 on the FRSM card in slot 20.

Example 1-410 Display the channel counters of all the channels on the FRSM card in slot 20

spirit3.1.20.FRSM.a > **xdspchancnt -chn 22**

```
ChanNum:          22
ChanState:        okay
ChanUpTime:       1634994
```

	Tx	Rx
	-----	-----
AbitState:	Sending A=1	Off
ATMState:	Not sending any state	Not receiving any state
Total Frames:	64187	57994
Total Bytes:	3410008	3317254
Frames DE:	0	0
Bytes DE:	0	0
Frames Discarded:	2	7079
Bytes Discarded:	118	410582
FramesDiscXceedQDepth:	0	0
BytesDiscXceedQDepth:	0	0
FramesDiscXceedDEThresh:	0	0
Frames FECN:	0	0
Frames BECN:	0	0
FramesTagged FECN:	0	0
FramesTagged BECN:	0	0
KbpsAIR:	0	0

Type <CR> to continue, Q<CR> to stop:

	Tx	Rx
	-----	-----
FramesTaggedDE:	0	0
BytesTaggedDE:	0	0
RcvFramesDiscShelfAlarm:		0
XmtFramesDiscPhyLayerFail:	0	
XmtFramesDiscCRCError:	0	
XmtFramesDiscReAssmFail:	0	
XmtFramesDiscSrcAbort:	0	
XmtFramesDuringLMIAAlarm:	14	
XmtBytesDuringLMIAAlarm:	794	
RcvFramesDiscUPC:		0
XmtFramesInvalidCPIs:	0	
XmtFramesLengthViolations:	0	
XmtFramesOversizedSDUs:	0	
XmtFramesUnknownProtocols:	0	
RcvFramesUnknownProtocols:		7079

Type <CR> to continue, Q<CR> to stop:

```
ChanNum:          42
ChanState:        alarm
ChanUpTime:       4
```

	Tx	Rx
	-----	-----
AbitState:	Sending A=0	Off
ATMState:	Sending AIS OAM state	Receiving AIS OAM
Total Frames:	0	0
Total Bytes:	0	0
Frames DE:	0	0
Bytes DE:	0	0
Frames Discarded:	0	0
Bytes Discarded:	0	0
FramesDiscXceedQDepth:	0	0
BytesDiscXceedQDepth:	0	0
FramesDiscXceedDEThresh:	0	0

```

Frames FECN:          0          0
Frames BECN:          0          0
FramesTagged FECN:   0          0
FramesTagged BECN:   0          0
KbpsAIR:              0          0

```

Type <CR> to continue, Q<CR> to stop:

```

                                Tx          Rx
                                -----
FramesTaggedDE:          0          0
BytesTaggedDE:          0          0
RcvFramesDiscShelfAlarm:          0
XmtFramesDiscPhyLayerFail: 0
XmtFramesDiscCRCError:  0
XmtFramesDiscReAssmFail: 0
XmtFramesDiscSrcAbort:  0
XmtFramesDuringLMIAAlarm: 0
XmtBytesDuringLMIAAlarm: 0
RcvFramesDiscUPC:          0          0
XmtFramesInvalidCPIs:   0
XmtFramesLengthViolations: 0
XmtFramesOversizedSDUs:  0
XmtFramesUnknownProtocols: 0
RcvFramesUnknownProtocols:          0

```

Example 1-411 Display the channel counters of channel 17 on the PXM card in slot 7

```
spirit4.1.1.7.PXM.a > xdspchancnt -cnt 17
```

```

Channel Number          :          17
Channel State           :          alarm
Channel Ingress State   :          alarm
Channel Egress State    :          other
CLP=0 Rcvd. Cells      :           0
CLP=1 Rcvd. Cells      :           0
GCRA1 Non Conforming Cells :          0
GCRA2 Non Conforming Cells :          0
EOF Cells Rcvd.        :           0
CLP=0 Discard Cells    :           0
CLP=1 Discard Cells    :           0
Total Xmtd. Cells      :         2125
CLP=0 Xmtd. Cells      :           0
CLP=1 Xmtd. Cells      :         3203
CLP=0 Discard Cells to Port :          0
CLP=1 Discard Cells to Port :          0

```

```
spirit4.1.1.7.PXM.a >
```

Example 1-412 Display the channel counters of all the channels on the CESM card in slot 21

```
spirit3.1.21.CESM.a > xdspchancnt

ChanNum:                33
Chan State:              alarm
Chan RCV ATM State:     Normal
Chan XMT ATM State:     Sending AIS OAM
Cell Loss Status:       No Cell Loss
Reassembled Cells:      0
Generated Cells:        1234508943
Header Errors:          0
Sequence Mismatches :   0
Lost Cells:             0
Channel Uptime (secs.)  1808376
Signalling Status       Offhook
```

Type <CR> to continue, Q<CR> to stop:

```
ChanNum:                41
Chan State:              alarm
Chan RCV ATM State:     Normal
Chan XMT ATM State:     Sending AIS OAM
Cell Loss Status:       Cell Loss
Reassembled Cells:      0
Generated Cells:        317857344
Header Errors:          0
Sequence Mismatches :   0
Lost Cells:             0
Channel Uptime (secs.)  77406
Signalling Status       Offhook
```

```
spirit3.1.21.CESM.a >
```

Example 1-413 Display the channel counters of channel 33 on the CESM card in slot 21

```
spirit3.1.21.CESM.a > xdspchancnt -chn 33

ChanNum:                33
Chan State:              alarm
Chan RCV ATM State:     Normal
Chan XMT ATM State:     Sending AIS OAM
Cell Loss Status:       No Cell Loss
Reassembled Cells:      0
Generated Cells:        1234551200
Header Errors:          0
Sequence Mismatches :   0
Lost Cells:             0
Channel Uptime (secs.)  1808438
Signalling Status       Offhook
```

```
spirit3.1.21.CESM.a >
```

Example 1-414 Display the channel counters of channel 22 on the FRSM card in slot 20

spirit3.1.20.FRSM.a > **xdspchancnt -chn 22**

```

ChanNum:                22
ChanState:              okay
ChanUpTime:            1635192

                                Tx                Rx
                                -----            -----
AbitState:              Sending A=1              Off
ATMState:               Not sending any state    Not receiving any state
Total Frames:           64187                    58001
Total Bytes:            3410008                  3317660
Frames DE:              0                        0
Bytes DE:               0                        0
Frames Discarded:      2                        7079
Bytes Discarded:       118                      410582
FramesDiscXceedQDepth: 0                        0
BytesDiscXceedQDepth:  0                        0
FramesDiscXceedDEThresh: 0                    0
Frames FECN:           0                        0
Frames BECN:           0                        0
FramesTagged FECN:     0                        0
FramesTagged BECN:     0                        0
KbpsAIR:               0                        0

```

Type <CR> to continue, Q<CR> to stop:

```

                                Tx                Rx
                                -----            -----
FramesTaggedDE:        0                        0
BytesTaggedDE:         0                        0
RcvFramesDiscShelfAlarm: 0                    0
XmtFramesDiscPhyLayerFail: 0
XmtFramesDiscCRCError: 0
XmtFramesDiscReAssmFail: 0
XmtFramesDiscSrcAbort: 0
XmtFramesDuringLMIAAlarm: 14
XmtBytesDuringLMIAAlarm: 794
RcvFramesDiscUPC:      0
XmtFramesInvalidCPIs: 0
XmtFramesLengthViolations: 0
XmtFramesOversizedSDUs: 0
XmtFramesUnknownProtocols: 0
RcvFramesUnknownProtocols: 7079

```

spirit3.1.20.FRSM.a >

xdspchans

Use the **xdspchans** command to view the current channels on the card.

Full Name

Display Channels

Card(s) on Which This Command Executes

PXM, FRSM, CESM

Syntax

xdspchans

Related Commands

xdspchan, dspchan, addchan, delchan

Attributes

Log: No State: Any Privilege: 1–6

Examples

This section contains the following examples.

- Display the channels on the current PXM.
- Display the channels on the current FRSM.
- Display the channels on the current CESM.

Example 1-415 Display the channels on the current PXM

```
spirit4.1.7.PXM.a > xdspchans

Chan Stat Intf locVpi locVci conTyp srvTyp PCR[0+1] Mst rmtVpi rmtVci State
-----
  17 ADD   2    39    45  VCC   VBR    353208 Slv   0    0  alarm

spirit4.1.7.PXM.a >
```

Example 1-416 Display the channels on the current FRSM

```
spirit3.1.20.FRSM.a > xdspchans
```

DLCI	Chan	EQ	I/EQDepth	I/EQDEThre	I/EECNThre	Fst/ DE	Type	Alarm
20.1.1.1000	22	2	65535/65535	32767/32767	6553/6553	Dis/Dis	SIW-X	No
20.8.20.300	42	2	65535/65535	32767/32767	6553/6553	Dis/Dis	NIW	Yes

```
Number of channels: 2
ChanNumNextAvailable: 26
```

```
spirit3.1.20.FRSM.a >
```

Example 1-417 Display the channels on the current CESM

```
spirit3.1.21.CESM.a > xdspchans
```

Channel	ChanNum	Status	CDVT	MaxBufSize	CLIP	CBRservice
21.1.2.33	33	Add	1000	124	2500	structured
21.3.10.41	41	Mod	20000	7680	30000	unstructured

Number of channels: 2
ChanNumNextAvailable: 47

```
spirit3.1.21.CESM.a >
```

xdspcon

Use the **xdspcon** command to view AUSM configuration data.

Full Name

Display Connection

Card(s) on Which This Command Executes

AUSM

Syntax

xdspcon -chn <channel number>

Syntax Description

-chn Command delineator that precedes the *channel number* entry.

channel number Channel number, in the range 16–1015.

Related Commands

dspcon, xaddcon, addcon, xdelcon, delcon, xdspcons, dspcons

Attributes

Log: No State: Any Privilege: 1–6

Example 1-418 Display the connection parameters for channel 16

```
spirit3.1.22.AUSM8.a > xdspcon -chn 16

ChanNum:                16
RowStatus:              Del
ConnectionType:        VCC
ServiceType:           CBR
PortNum:                1
VPI:                   0
VCI (For VCC):         0
Local VPId(for VPC):   0
EgressQNum:            0
IngressQDepth(cells):  1000
IngressDiscardOption:  CLP hysteresis
IngressFrameDiscardThreshold: 1000
IngressQCLPHigh(cells): 900
IngressQCLPLow(cells): 800
QCLPState:             LOW
IngressEfciThreshold(cells): 1000

UPCEnable:             Enabled
PeakCellRate[0+1](cells/sec): 50
CellDelayVariation[0+1]: 10000 (micro secs)
PeakCellRate[0](cells/sec): 50
CellDelayVariation[0]: 10000 (micro secs)
SustainedCellRate(cells/sec): 50
```

Type <CR> to continue, Q<CR> to stop:

```
MaximumBurstSize(cells):      1000
SCRPolicing:                  CLP[0]
CLPTagEnable:                 Enabled
FrameGCRAEnable:             Disable

ForesightEnable:             Disable
InitialBurstSize(cells):      0
ForeSightPeakCellRate(cells/sec): 50
MinimumCellRate(cells/sec):   0
InitialCellRate(cells/sec):   1

LocalRemoteLpbkState:        Disable
ChanTestType:                No Test
ChanTestState:               Not In Progress
ChanRTDresult:               65535 ms

Ingress percentage util:      100
Egress percentage util :      100
Egress Service Rate:         50
LocalVpi:                    0
LocalVci:                    0
```

spirit3.1.22.AUSM8.a >

Type <CR> to continue, Q<CR> to stop:

```
LocalNSAP:                    5468697320697320612064756d6d79204e534150
RemoteVpi:                    0
RemoteVci:                    0
RemoteNSAP:                   5468697320697320612064756d6d79204e534150
Mastership:                   Slave
VpcFlag:                      Vcc
ConnServiceType:              CBR
RoutingPriority:              1
MaxCost:                      255
RestrictTrunkType:            No Restriction
ConnPCR:                      50
ConnMCR:                      0
ConnPercentUtil:             100

ChanNumNextAvailable         : 16
Local VpId NextAvailable     : 4
```

spirit3.1.22.AUSM8.a >

xdspcons

Use the **xdspcons** command to view details of all connections between the current AUSM and the card to which the current shelf is attached.

Full Name

Display Connections

Card(s) on Which This Command Executes

AUSM

Syntax

xdspcons

Related Commands

dspcons, xaddcon, addcon, xdelcon, delcon, xdspcon

Attributes

Log: No State: Any Privilege: 1–6

Example 1-419 Display parameters for the connections on the current AUSM

```
spirit.1.19.AUSM8.a > xdspcons
```

Chan	Port.VPI.VCI	ConnType	Service Type	PCRLot1	Q-Depth	State
30	1.10.100	VCC	ABR	3622	2000	Active
33	1.10.200	VPC	CBR	3622	100	Alarm

```
spirit.1.19.AUSM8.a >
```

xdspdsx3bert

Use the **xdspdsx3bert** command to view parameters and results of the current BERT testing session.

Full Name

Display DSX3 BERT

Card(s) on Which This Command Executes

FRSM 2T3E3, CESMT3

Syntax

xdspdsx3bert

Attributes

Log: No State: Active Privilege: Any

Example 1-420 Display the results of the current BERT testing session

```
popeye1.1.21.CESMT3.a > xdspdsx3bert

Bert Control:                               Start dsx3Bert
Bert Resource Status State:                 In Use
Bert Owner:                                 CLI
Bert Status:                                In Sync
Bert Test Medium:                           Line
Bert Port:                                  1
Line Number :                               1
Bert Mode :                                 bertPatternTest
Bert Pattern :                               doubleOneZero
Loopback type:                              metallicLoopback
Start time (secs.):                          14:14:44
Start Date                                  FRI JUL 02 1999
Bit countupper:                              0
Bit countlower:                             1553476045
Bit Error Countupper                         0
Bit Error Countlower                         0
Error Insertion Rate:                        Error injection disabled
Error Insertion count:                       0

DSX3 BERT in Sync

popeye1.1.21.CESMT3.a >
```

xdspilmi

Use the **xdspilmi** command to view the interim local management interface (ILMI) configuration.

Full Name

Display ILMI

Card(s) on Which This Command Executes

PXM, AUSM

Syntax: PXM

xdspilmi -ifNum <*sigPortNum*>

Syntax Description

-ifNum Command delineator that precedes the *sigPortNum* entry.

sigPortNum Number of the broadband interface port.

Syntax: AUSM

xdspilmi -pt <*PortNum*>

Syntax Description

-pt Command delineator that precedes the *PortNum* entry.

PortNum Number of the broadband interface port.

Related Commands

cnfilmi, xcfnfilmi, dspilmicnt

Attributes

Log: No State: Any Privilege: 1–6

Examples

This section contains the following examples.

- Display the ILMI configuration for port 1 on the PXM.
- Display the ILMI configuration for port 1 on the AUSM.

Example 1-421 Display the ILMI configuration for port 1 on the PXM

```
poriky.1.7.PXM.a > xdspilmi -ifNum 1

  Sig.      Ilmi      Sig  Sig  Ilmi      T491      T492  T493  Addr
  Port State/Type  Vpi  Vci Trap/Int KA ErrTh/Pollint EvntTh EnqInt Reg.
  -----
    1 Off/none      0  16 Off/01  Off    3/v6      4    10   Off

poriky.1.7.PXM.a >
```

Example 1-422 Display the ILMI configuration for port 1 on the AUSM

```
poriky.1.19.AUSM8.a > xdspilmi -pt 1

Port Num:                1
Signalling:              No signalling
SignallingVPI:           0
SignallingVCI:           0
ILMITrap:                Disabled
ILMI-Min-Trap-Interval (secs): 1
KeepAlivePolling:        Disabled
ErrorThreshold:          3
EventThreshold:          4
PollingInterval (secs): 30
MinimumEnquiryInterval (secs) 10
EXT Operation:           port 2

poriky.1.19.AUSM8.a >
```

xdspln

Use the **xdspln** command to view configuration for a specified line.

Full Name

Display Line Configuration

Card(s) on Which This Command Executes

FRSM, AUSM, CESM

Syntax

xdspln -ds1 <line number>

or

xdspln -rs232 <line number>

Syntax Description

-ds1	Command delineator that precedes T1 <i>line number</i> entry.
-rs232	Command delineator that precedes RS232 <i>line number</i> entry.
<i>line number</i>	Line number of the DS1 or RS232 interface. <ul style="list-style-type: none">• -ds1 range = 1–8 (on 8-port service modules)• -rs232 range = 1–2

Related Commands

addln, xcnfln, cnfln, delln

Attributes

Log: No State: Any Privilege: 1–6

Examples

This section contains the following examples.

- Display line 2 on the current AUSM card.
- Display line 8 on the current CESM card.
- Display line 1 on the current FRSM card.
- Display the RS232 line 1 on the current CESM card.

Example 1-423 Display line 2 on the current AUSM card

```
spirit3.1.22.AUSM8.a > xdspln -ds1 2

LineNum:                2
LineConnectorType:      RJ-48
LineType:                dsx1ESF
LineEnable:             Disable
LineCoding:             dsx1B8ZS
LineLength:             0-131 ft
LineXmtClockSource:     LocalTiming
LineLoopbackCommand:    NoLoop
LineSendCode:           NoCode
LineUsedTimeslotsBitMap: 0xffffffff
LineLoopbackCodeDetection: codeDetectDisabled
LineBERTEnable:        Disable

LineNumOfValidEntries:  8

spirit3.1.22.AUSM8.a >
```

Example 1-424 Display line 8 on the current CESM card

```
spirit.1.17.CESM.a > xdspln -ds1 8

LineNum:                8
LineConnectorType:      SMB
LineEnable:             Enabled
LineType:                dsx1E1CAS
LineCoding:             dsx1HDB3
LineLength:             G.703 75 ohm
LineXmtClockSource:     LocalTiming
LineLoopbackCommand:    NoLoop
LineSendCode:           NoCode
LineUsedTimeslotsBitMap: 0x0
LineLoopbackCodeDetection: codeDetectDisabled

LineNumOfValidEntries:  8

spirit.1.17.CESM.a >
```

Example 1-425 Display line 1 on the current FRSM card

```
spirit.1.1.FRSM.a > xdspln -ds1 1

LineNum:                1
LineConnectorType:      RJ-48
LineType:                dsx1ESF
LineEnable:             Disable
LineCoding:             dsx1B8ZS
LineLength:             0-131 ft
LineXmtClockSource:     LocalTiming
LineLoopbackCommand:    NoLoop
LineSendCode:           NoCode
LineUsedTimeslotsBitMap: 0x0
LineLoopbackCodeDetection: codeDetectDisabled
LineBertEnable:        Disable

LineNumOfValidEntries:  8

spirit.1.1.FRSM.a >
```

Example 1-426 Display the RS232 line 1 on the current CESM card

```
spirit3.1.21.CESM.a > xdspln -rs232 1

Port          Type          Enable  Baudrate
-----
21.1  Maintenance RS232 Port  Disable  19200

SerialPortNumOfValidEntries: 1

spirit3.1.21.CESM.a >
```

xdsplns

Use the **xdsplns** command to view the configuration parameters for all lines on the current card.

Full Name

Display Lines

Card(s) on Which This Command Executes

PXM FRSM, AUSM, CESM

Syntax

xdsplns

Related Commands

dsplns, addln, xaddln, cnfln, xcfln, xdeln, deln

Attributes

Log: No State: Any Privilege: 1–6

Examples

This section contains the following examples.

- Display DS1 lines on the current FRSM card.
- Display RS-232 lines on the current FRSM card.
- Display lines on the current PXM with a T3 trunk back card.
- Display lines on the current PXM with a SONET 155 back card.
- Display E1 lines on the current CESM card.

Example 1-427 Display DS1 lines on the current FRSM card

```
spirit.1.1.FRSM.a > xdsplns -ds1
```

Line	Conn Type	Type	Status/Coding	Length	XmtClock Source	Alarm	Stats Alarm
1.1	RJ-48	dsx1ESF	Dis/dsx1B8ZS	0-131 ft	LocalTim		
1.2	RJ-48	dsx1ESF	Dis/dsx1B8ZS	0-131 ft	LocalTim		
1.3	RJ-48	dsx1ESF	Dis/dsx1B8ZS	0-131 ft	LocalTim		
1.4	RJ-48	dsx1ESF	Dis/dsx1B8ZS	0-131 ft	LocalTim		
1.5	RJ-48	dsx1ESF	Dis/dsx1B8ZS	0-131 ft	LocalTim		
1.6	RJ-48	dsx1ESF	Dis/dsx1B8ZS	0-131 ft	LocalTim		
1.7	RJ-48	dsx1ESF	Dis/dsx1B8ZS	0-131 ft	LocalTim		
1.8	RJ-48	dsx1ESF	Dis/dsx1B8ZS	0-131 ft	LocalTim		

```

LineNumOfValidEntries: 8

spirit.1.1.FRSM.a >

```

Example 1-428 Display RS-232 lines on the current FRSM card

```
spirit.1.1.FRSM.a > xdsplns -rs232

Port          Type          Enable  Baudrate
-----
1.1  Maintenance RS232 Port  Disable  19200

SerialPortNumOfValidEntries: 1
spirit.1.1.FRSM.a >
```

Example 1-429 Display lines on the current PXM with a T3 trunk back card

```
spirit.1.7.PXM.a > xdsplns

Line          Type          Coding      Length      Criteria  AIScBitsCheck
-----
2.1  dsx3CbitParity dsx3B3ZS  LessThan450ft  3 out of 8  Check C-bits

LineNumOfValidEntries: 1

spirit.1.7.PXM.a >
```

Example 1-430 Display lines on the current PXM with a SONET 155 back card

```
spirit.1.7.PXM.a > xdsplns

Medium  Medium  Medium  Medium
Sonet   Line    Line    HSC      Payload  Frame    Time      Valid      Line    Line
Line    Type    Lpbk    mask     Scramble Scramble Elapsed   Intvls     Coding  Type
-----

LineNumOfValidEntries: 1

spirit.1.7.PXM.a >
```

Example 1-431 Display E1 lines on the current CESM

```
spirit.1.17.CESM.a > xdsplns -ds1

Line  Conn  Type          Status/Coding      Length      XmtClock Alarm Stats
      Type                                     Source        Alarm
-----
17.1  SMB   dsx1E1CAS     Ena/dsx1HDB3 G.703 75 ohm LocalTim Yes  No
17.2  SMB   dsx1E1CAS     Dis/dsx1HDB3 G.703 75 ohm LocalTim
17.3  SMB   dsx1E1CAS     Dis/dsx1HDB3 G.703 75 ohm LocalTim
17.4  SMB   dsx1E1CAS     Dis/dsx1HDB3 G.703 75 ohm LocalTim
17.5  SMB   dsx1E1CAS     Dis/dsx1HDB3 G.703 75 ohm LocalTim
17.6  SMB   dsx1E1CAS     Dis/dsx1HDB3 G.703 75 ohm LocalTim
17.7  SMB   dsx1E1CAS     Dis/dsx1HDB3 G.703 75 ohm LocalTim
17.8  SMB   dsx1E1CAS     Ena/dsx1HDB3 G.703 75 ohm LocalTim Yes  No

LineNumOfValidEntries: 8

spirit.1.17.CESM.a >
```

xdspport

Use the **xdspport** command on the PXM to view the port configuration for the specified PXM port.

Use the **xdspport** command on an FRSM and CESM to view the port configuration for the specified port.

Use the **xdspport** command on an AUSM to view the Physical Layer Protocol Processor of a port on the current AUSM.

Full Name

Display Port

Card(s) on Which This Command Executes

PXM, FRSM, AUSM, CESM

Syntax

xdspport <port number>

or

xdspport -port <port number>
(for PXM)

Syntax Description

-port	Command delineator that precedes PXM <i>port number</i> entry.
<i>port number</i>	Port number, using the range appropriate for the current card. <ul style="list-style-type: none">• PXM<ul style="list-style-type: none">— Range = 1–32• FRSM<ul style="list-style-type: none">— T1 range = 1–192— E1 range = 1–248• AUSM range = 1–8• CESM<ul style="list-style-type: none">— 8T1 range = 1–192— 8E1 range = 1–248— T3E3 = enter the value 1

Related Commands

FRSM and CESM: **addport**, **xcnfport**, **cnfport**, **delpport**

AUSM: **xupport**, **upport**, **xdnport**, **dnport**

Attributes

Log: No State: Active Privilege: 1–6

Examples

This section contains the following examples.

- Display the port configuration for port 2 on the PXM.
- Display the port configuration for port 1 on the current FRSM.
- Display port 1 on the current AUSM.

Example 1-432 Display the port configuration for port 2 on the PXM

```
raviraj.1.7.PXM.a > xdspport -port 1

  Port  Status  Line  PctBw  minVpi  maxVpi
-----
    1     OFF    0      0      0      0

raviraj.1.7.PXM.a >
```

Example 1-433 Display the port configuration for port 1 on the current FRSM

```
spirit.1.17.FRSM.a > xdspport 1

SlotNum:                17
PortLineNum:            1
PortNum:                1
PortRowStatus:          Add
PortDs0Speed:           64k
PortDs0ConfigBitMap:    0xffffffff
PortEqueueServiceRatio: 1
PortFlagsBetweenFrames: 1
PortSpeed:              1536kbps
SignallingProtocolType: NoSignalling
AsynchronousUpdates:    Disable
T391LineIntegrityTimer: 10
T392PollingVerificationTimer: 15
N391FullStatusPollingCounter: 6
N392ErrorThreshold:     3
N393MonitoredEventCount: 4
PortState:              FailedDuetoLineFailure
PortSignallingState:    No Signalling Failure
CLLMEnableStatus:       Disable
CLLMxmtStatusTimer:     0

PortDs0UsedLine1:       0x00ffffff
PortDs0UsedLine2:       0x00ffffff
PortDs0UsedLine3:       0x00ffffff
PortDs0UsedLine4:       0x00ffffff
PortNumNextAvailable:   60
Syntax : dspport "port_num"
         port number-values ranging from 1-192 are accepted

spirit.1.17.FRSM.a >
```

Example 1-434 Display port 1 on the current AUSM

```
spirit.1.20.AUSM.a > xdspport 1  
  
PortNumber:      1  
Cell Framing:    ATM  
Cell Scramble:   No Scramble  
Plpp Loopback:   No Loopback  
  
spirit.1.20.AUSM.a >
```

xdspportcnt

Use the **xdspportcnt** command to view counters for a specified port on an FRSM or AUSM.

Full Name

Display Port Counters

Card(s) on Which This Command Executes

FRSM, AUSM

Syntax

xdspportcnt <port number>

Syntax Description

port number Port number, using the range appropriate for the current card.

- FRSM T1 range = 1–192
- FRSM E1 range = 1–248
- AUSM range = 1–8

Related Commands

cnfcd, **dspcds**

Attributes

Log: No

State: Any

Privilege: 1–6

Examples

This section contains the following examples:

- Display port counters on port 1 of the current AUSM.
- Display port counters on port 1 of the current FRSM.

Example 1-435 Display port counters on port 1 of the current AUSM

```
spirit.1.20.AUSM.a > dspportcnt 1

PortNum:                1
PortState:              Sig. Failure
IngressRcvCells:        0
IngressRcvCellRate (cells/sec): 0
IngressRcvUtilization (percentage): 0
IngressXmtCells:        0
IngressGFCErrorsCells: 0
IngressVpiVciErrCells: 0
IngressUnknownVpiVci: 0x0
IngressRcvClpSetCells: 0
EgressRcvCells:         0
EgressRcvCellRate (cells/sec): 0
EgressRcvUtilization (percentage): 0
EgressXmtCells:         0
EgressXmtCellRate (cells/sec): 0
EgressXmtUtilization (percentage): 0
EgressPortAlarmDiscardCells: 0
EgressXmtClpSetCells:  0
EgressXmtEfciSetCells: 0
PortXmtAisCells:        0
PortXmtSgmtLpbkCells:  0
PortRcvAisCells:        0
PortRcvFerfCells:       0
PortRcvSgmtLpbkCells:  0
PortRcvCrcErrOAMCells: 0
TotalIngressQFullDiscardCells: 0
TotalIngressClpSetDiscardCells: 0
TransmitFIFOFullCount (per card): 0
ReceivedHECErrorsCells: 0
HECErrorredSeconds:     0
SeverelyHECErrorredSeconds: 0

spirit.1.20.AUSM.a >
```

Example 1-436 Display port counters on port 1 of the current FRSM

```
spirit.1.17.FRSM.a > dspportcnt 1

PortNum: 1

                Tx                Rx
-----
Total Frames:   233706             228459
Total Bytes:   6181533            5892272
Frames FECN:    0                  0
Frames BECN:    0                  0
Frames Abort:   0                  2
Buf Not Available: 0                0
KbpsAIR:        0                  0
XmtFramesDiscXceedQDepth: 0
XmtBytesDiscXceedQDepth: 0
XmtFramesDuringLMIAAlarm: 17
XmtByteDuringLMIAAlarm: 791
XmtFramesUnderrun: 0
RcvFramesDE:    0
RcvFramesDiscCRCError: 0
RcvFramesDiscIllegalHeader: 0
RcvFramesDiscAlignmentError: 0
RcvFramesDiscIllegalLen: 0
RcvFramesDiscXceedDEThresh: 0
RcvFramesDiscNoChan: 0
RcvFramesUnknownDLCI: 2
RcvLastUnknownDLCI: 0
RcvFramesTaggedFECN: 0
RcvFramesTaggedBECN: 0
RcvFramesTaggedDE: 0
Status:         169459            0
StatusInquiry:  0                  169459
AsynchUpdate:   0
RcvInvalidRequest: 0
RcvUNISegMismatch: 1
RcvNNISegMismatch: 0
UNISignallingTimeout: 3
NNISignallingTimeout: 0
FramesCLLM:     0
BytesCLLM:      0
CLLMFailures:   0Type <CR> to continue, Q<CR> to stop:

PortNum: 20

                Tx                Rx
-----
Total Frames:   0                  0
Total Bytes:    0                  0
Frames FECN:    0                  0
Frames BECN:    0                  0
Frames Abort:   0                  0
Buf Not Available: 0                0
KbpsAIR:        0                  0
XmtFramesDiscXceedQDepth: 0
XmtBytesDiscXceedQDepth: 0
XmtFramesDuringLMIAAlarm: 0
XmtByteDuringLMIAAlarm: 0
XmtFramesUnderrun: 1
RcvFramesDE:    0
RcvFramesDiscCRCError: 0
RcvFramesDiscIllegalHeader: 0
RcvFramesDiscAlignmentError: 0
RcvFramesDiscIllegalLen: 0
```

```
RcvFramesDiscXceedDEThresh: 0
RcvFramesDiscNoChan: 0
RcvFramesUnknownDLCI: 0
RcvLastUnknownDLCI: 0
RcvFramesTaggedFECN: 0
RcvFramesTaggedBECN: 0
RcvFramesTaggedDE: 0
Status: 0 0
StatusInquiry: 0 0
AsynchUpdate: 0 0
RcvInvalidRequest: 0
RcvUNISegMismatch: 0
RcvNNISegMismatch: 0
UNISignallingTimeout: 0
NNISignallingTimeout: 0
FramesCLLM: 0 0
BytesCLLM: 0 0
CLLMFailures: 0
```

spirit3.1.20.FRSM.a >

xdspportq

Use the **xdspportq** command to view queue information for a specified port and egress queue on the AUSM.

Full Name

Display a Specified Egress Queue on the Specified Port

Card(s) on Which This Command Executes

AUSM

Syntax

xdspportq -pt <port number> -pqn <egress queue number>

Syntax Description

-pt Command delineator that precedes the *port number* entry.

port number Port number, in the range 1–8.

-pqn Command delineator that precedes the *egress queue number* entry.

egress queue number Egress queue number, in the range 1–16.

Related Commands

dspportq, dspportqs

Attributes

Log: No State: Any Privilege: 1–6

Example 1-437 Display queue information for egress queue 1 on port 1

```
spirit3.1.22.AUSM8.a > xdspportq -pt 1 -pqn 1

ServicePortNum:          1
QueueNumber:             1
PortBinState:            Disable
ServiceSequence:         255
QueueDepth(cells):       500
CLPThresholdHigh(cells): 450
CLPThresholdLow(cells):  400
EFCIThreshold(cells):    400
QueueAlgorithm:          255
MaxBandwidthIncrement:   4096
MinBandwidthIncrement:   0
QCLPState:               Low
QFullDiscardedCells:     0
CLPSetDiscardedCells:    0

spirit3.1.22.AUSM8.a >
```

xdspportqs

Use the **xdspportqs** command to view queue information for all the egress queues on an AUSM port.

Full Name

Display All Egress Queues on a Specified Port

Card(s) on Which This Command Executes

AUSM

Syntax

xdspportqs <port number>

Syntax Description

port number Port number, in the range 1–8.

Related Commands

dspportqs, **xdspportq**, **dspportq**

Attributes

Log: No State: Any Privilege: 1–6

Example 1-438 Display egress queue information for all the egress queues on port 1

spirit.1.20.AUSM.a > **xdspportqs 1**

Port	Q Num	State	Q-Algo	Service-Seq	Depth-Max	CLP-High	CLP-Low	EFCI-Thrsh
1	1	Enabled	3	1	200	180	160	160
1	2	Enabled	3	2	900	800	700	700
1	3	Enabled	3	3	900	800	700	700
4	1	Enabled	3	1	200	180	160	160
4	2	Enabled	3	2	900	800	700	700
4	3	Enabled	3	3	900	800	700	700

spirit.1.20.AUSM.a >

xdsports

Use the **xdsports** command to view information on all the ports associated with the current card.

Full Name

Display Ports

Card(s) on Which This Command Executes

FRSM, AUSM, CESM

Syntax

xdsports

Related Commands

dsport, addport, cnfport, delpport, dsport

Attributes

Log: No

State: Any

Privilege: 1–6

Example 1-439 Display the ports on the current FRSM

raviraj.1.3.FRSM.a > **xdsports**

Port	Ena/Speed	EQServ	SignalType	T391	T392	N391	N392	N393	Type	Alarm	ELMI
3.1.1	Add/ 192k	1	NoSignalling	10	15	6	3	4	frameRel	No	Off
3.1.2	Add/ 192k	1	NoSignalling	10	15	6	3	4	frameRel	No	Off
3.1.3	Add/ 192k	1	NoSignalling	10	15	6	3	4	frameRel	No	Off
3.1.4	Add/ 192k	1	NoSignalling	10	15	6	3	4	frameRel	No	Off
3.1.5	Add/ 192k	1	NoSignalling	10	15	6	3	4	frameRel	No	Off
3.1.6	Add/ 192k	1	NoSignalling	10	15	6	3	4	frameRel	No	Off
3.1.7	Add/ 192k	1	NoSignalling	10	15	6	3	4	frameRel	No	Off
3.1.8	Add/ 192k	1	NoSignalling	10	15	6	3	4	frameRel	No	Off

Number of ports: 8

PortDs0UsedLine1: 0x00ffffff
PortDs0UsedLine2: 0x00000000
PortDs0UsedLine3: 0x00000000
PortDs0UsedLine4: 0x00000000
PortDs0UsedLine5: 0x00000000
PortDs0UsedLine6: 0x00000000
PortDs0UsedLine7: 0x00000000
PortDs0UsedLine8: 0x00000000
PortNumNextAvailable: 89

raviraj.1.3.FRSM.a >

xdspred

Use the **xdspred** command to view the currently configured redundant slot links on the switch.

Full Name

Display Redundancy

Card(s) on Which This Card Executes

PXM

Syntax

xdspred

Related Commands

addred, delred, dspred, xcnpred

Attributes

Log: No State: Active Privilege: SuperUser

Example 1-440 Show the status of redundant slot links

```
raviraj.1.7.PXM.a > xdspred
```

Primary SlotNum	Primary Type	Primary State	Secondary SlotNum	Secondary Type	Secondary State	Red. Type	Red.Slot Cover
4	FRSM-2CT	Active	10	FRSM-2CT	Standby	1:1	0

```
raviraj.1.7.PXM.a >
```

xdspshelf

Use the **xdspshelf** command to view shelf information on card and line status.

Full Name

Display Shelf

Card(s) on Which This Command Executes

PXM

Syntax

xdspshelf

Related Commands

dspshelf

Attributes

Log: No

State: Any

Privilege: Cisco_GP

Example 1-441 Display characteristics of the shelf information on card and line status

```
spirit.1.8.PXM.a > xdspshelf

  NumOfValidEntries:    32
  NodeName:             spirit
  Date:                 01/29/1999
  Time:                 18:12:48
  TimeZone:             GMT
  TimeZoneGMTOff:      0
  StatsMasterIpAddress: 0.0.0.0
  shelfIntegratedAlarm: Clear
  BkplnSerialNum:      12345
  BkplnType:           2
  BkplnFabNumber:      80
  BkplnHwRev:          80

spirit.1.8.PXM.a >
```

xdpsrmlink

Use the **xdpsrmlink** command to view a link on a specific T3 line on an SRM-3T3 card.

Full Name

Display Link

Card(s) on Which This Command Executes

PXM

Syntax

```
xdpsrmlink -srmt3 <T3LineNum> -srmt1 <T1Slot> -srmsl <TargetSlotNum> <T3LineNum>
```

Syntax Description

-srmt3 Command delineator that precedes the *T3LineNum* entry.

T3LineNum T3 line number expressed in the form *Slot.Line*.

- Line range = 1–3
- Slot = enter value of either 15 or 31

-srmt1 Command delineator that precedes the *T1Slot* entry.

T1Slot T1 slot number, in the range 1–28.

-srmsl Command delineator that precedes *TargetSlotNum* and *T3LineNum* entry.

TargetSlotNum T1 service module slot number to be linked to the T1 line, in the ranges 1–6, or 11–14, or 17–22, or 27–30.

T3LineNum T3 line number in the form *slot.line*.

Slot range = 15, 31

Line range = 1–3

Related Commands

dellink, addlink

Attributes

Log: No

State: Any

Privilege: Any

Example 1-442 Display characteristics of the SRM T3 link

```
spirit.1.8.PXM.a > xdpsrmlink 7.1
```

T3Line	StartT	TRowStatus	TargetSlot	TargetSlotLine
1	1	Add	7	1
1	2	Add	7	2
1	3	Add	7	3
1	4	Add	7	4

xdspttrapmgr

Use the **xdspttrapmgr** command to view trap information collected by the PXM trap manager. This information contains the IPAddress, port number, trap flag operational status, row status, and the current sequence number of the next trap.

Full Name

Display Trap Manager

Card(s) on Which This Command Executes

PXM

Syntax

xdspttrapmgr

Related Commands

cnftrapmgr

Attributes

Log: No State: Any Privilege: Any

Example 1-443

```
raviraj.1.7.PXM.a > xdspttrapmgr
```

ipAddress	PortNum	RowStatus	ReadTrapFlag	NextTrapSeqNum
-----	-----	-----	-----	-----
172.29.28.41	2500	Add	Off	260338

```
LastTrapSeqNum: 260837
```

```
NumOfValidEntries: 1
```

```
raviraj.1.7.PXM.a >
```

xdspusers

Use the **xdspusers** command to view the list of currently configured user identifications and associated access levels.

Full Name

Display User(s)

Card(s) on Which This Command Executes

PXM

Syntax

xdspusers

or

xdspusers -u <userId>

Syntax Description

-u Command delineator that precedes the *userId* entry.

userId String of up to 12 characters that identify a specific user.

Related Commands

dspusers

Attributes

Log: No

State: Any

Privilege: CISCO_GP

Examples

This section contains the following examples.

- Show all currently configured users.
- Show the access level for a specified user.

Example 1-444 Show all currently configured users

```
raviraj.1.7.PXM.a > xdspusers
```

```
UserId      AccessLevel
-----
cisco       CISCO_GP
service     SERVICE_GP
superuser   SUPER_GP
```

```
raviraj.1.7.PXM.a >
```

Example 1-445 Show access level for a specified user

```
raviraj.1.7.PXM.a > xdspuser -u superuser
```

```
UserId      AccessLevel  
-----  
superuser   SUPER_GP
```

```
raviraj.1.7.PXM.a >
```

xupport

Use the **xupport** command to bring up a port on the AUSM.

Full Name

Up Port

Card(s) on Which This Command Executes

AUSM

Syntax

```
xupport -pt <PortNum> -e <PortEnable> -ptyp <PortType> -ln <PhysLineNum>
```

Syntax Description

-pt	Command delineator that precedes the <i>PortNum</i> entry.
<i>PortNum</i>	Port number, in the range 1–8.
-e	Command delineator that precedes the <i>PortEnable</i> entry.
<i>PortEnable</i>	Value that enables or disables the port. <ul style="list-style-type: none">• 1 = disable• 2 = enable
-ptyp	Command delineator that precedes the <i>PortType</i> entry.
<i>PortType</i>	Value that represents either NNI or UNI port type. <ul style="list-style-type: none">• 1 = NNI• 2 = UNI
-ln	Command delineator that precedes the <i>PhysLineNum</i> entry.
<i>PhysLineNum</i>	Physical line number, in the range 1–8.

Related Commands

upport, xdnport, dnport

Attributes

Log: Yes State: Active Privilege: 1

Example 1-446 Bring up port 1 on physical line 1 on the AUSM in slot 22 as an NNI port

```
spirit3.1.22.AUSM8.a > xupport -pt 1 -e 2 -ptyp 1 -ln 1  
spirit3.1.22.AUSM8.a >
```

A system message does not occur unless an error is detected.

Configuration Sequences

This chapter provides a quick reference to command sets typically used when setting up card functions.

- SRM Configurations
 - Setting up SRM Line(s) and Link(s)
 - Setting 1:N Redundancy
- CESM Configurations
 - Setting up CESM Connectivity
 - Debugging CESM
 - Running CESM Tests
- FRSM Configurations
 - Setting Up FRSM Connectivity
 - Running FRSM Tests
- AUSM Configurations
 - Setting Up AUSM Connectivity
 - Debugging AUSM
 - Running AUSM Tests

SRM Configurations

This section contains typical command sequences associated with the MGX 8800 Service Resource Module.

Setting up SRM Line(s) and Link(s)

Do this configuration at the PXM.

- Step 1** *Enable the SRM T3 line.* **addln -ds3** <slot.line>
- Step 2** *Verify.* **dsplns** <lineTable> <SlotNum>
- Step 3** *Add the link.* **addlink** <T3Slot.Line> <T1Slot> <TargetSlotNum> <TargetSlotLineNum>
- Step 4** *Verify.* **dsplink** <T3Slot.Line>

Setting 1:N Redundancy

Do this configuration at the PXM.

- Step 1** *Set redundancy.* **addred** <redPrimarySlotNum> <redSecondarySlotNum> <redType>
- Step 2** *Verify.* **dspred**

Note Use the **softswitch** command to switch between the primary and secondary slots.

CESM Configurations

This section contains typical command sequences associated with the MGX 8800 Circuit Emulation Service Module.

Setting up CESM Connectivity

Bring up the CESM command prompt to do this configuration.

Step 1	<i>Set card resource partitions.</i>	cnfcdrsprtn <PAR_max_conns> <PNNI_max_conns> <Tag_max_conns>
Step 2	<i>Verify.</i>	dspcdrsprtn
Step 3	<i>Add Line.</i>	addln <line number>
Step 4	<i>Configure line.</i>	
	• T1	• cnfln <line_num> <line_code> <line_len> <clk_src> [E1-signalling]
	• T3	• cnfln <line_num> <line_code> <line_len> <clk_src>
Step 5	<i>Verify.</i>	
	• Check all lines	• dsplns
	• View specific line	• dspln <line_num>
Step 6	<i>Add Port.</i>	
	• T1	• addport <port_num> <line_num> <begin_slot> <num_slot> <port_type>
	• T3	• addport <port_num> <line_num>
Step 7	<i>Verify.</i>	
	• Check all ports	• dspports
	• View specific port	• dspport <port_num>
Step 8	<i>Set port resource partitions.</i>	cnfportrsprtn <port_num> <controller_name>
Step 9	<i>Verify.</i>	dspportrsprtn
Step 10	<i>Add Connection.</i>	
	• T1	• addcon <port_number> <signalling type> <partial_fill> <cond_data> <cond_signalling> <controller_type> <mastership> <RemoteEndConnID>
	• T3	• addcon <port_num> [mastership] [remoteConnID]
Step 11	<i>Verify.</i>	dspscon
Step 12	<i>Configure Channel.</i>	
	• T1	• cnfcon <port_num> <CDVT> <CLIP> <bufsize> <clockmode> <IdleSuppEnable> <ForceIdleSuppression>
	• T3	• cnfcon <port> <CDVT> <CellLossIntegPeriod> <bufsize>
Step 13	<i>Verify.</i>	
	• Check all connections	• dspscons
	• View specific connection	• dspscon

Debugging CESM

Checking CESM Connectivity

Bring up the CESM command prompt to perform the following debugging functions.

- *Display alarms* **dspalms** <lineType>
- *Display alarm count* **dspalment -ds3** <LineNum> | **-e3** <LineNum> | **-ds1** <LineNum>
- *Display channel counters* **dspchancnt** <channel number>
- *Display SAR counters* **dspsarent** <ChanNum>
- *Test the connection* **tstcon** <port_num>
- *Test the delay* **tstdelay** <chan_num>

Running CESM Tests

- Setting Up BERT Session on a CESM
- Setting Up Local Loopback Testing on a Low-Speed FRSM

Setting Up Local Loopback Testing on a CESM

Bring up the CESM command prompt to set up the following loopback functions on T1 or T3 lines:

Step 1 *Add Line Loop.* **addlnloop** <line number>

Step 2 *Remove Line Loop.* **dellnloop** <line number>

Setting Up BERT Session on a CESM

Bring up the CESM command prompt.

Step 1 *Acquire BERT.* **acqdsx3bert**

Step 2 *Reset BERT counters.* **clrbertcntrs**

Step 3 *Start BERT.* **startdsx3bert**

Step 4 *Display BERT detail.* **dspdsx3bert**

Step 5 *Stop BERT.* **deldsx3bert**

FRSM Configurations

This section contains typical command sequences associated with the MGX 8800 Frame Relay Service Module.

Setting Up FRSM Connectivity

Bring up the FRSM command prompt to do this configuration.

- | | | |
|----------------|--------------------------------------|---|
| Step 1 | <i>Set card resource partitions.</i> | cnfcdrcsprtn <PAR_max_conns> <PNNI_max_conns> <Tag_max_conns> |
| Step 2 | <i>Verify.</i> | dspcdrsprtn |
| Step 3 | <i>Add Line.</i> | |
| | • 8T1/E1, 2CT3, 2T3/E3 | • addln <line number> |
| | • HS1/B, HS2 | • addln <line number> <line type> <line rate> |
| Step 4 | <i>Configure Line.</i> | |
| | • 8T1/E1, 2CT3, 2T3/E3 | • cnfln <line number> <line code> <line length> <clock source> [E1 signalling] |
| | • HS1/B, HS2 | • cnfds3ln <DS3 line number> <line type> <line rate> <clock source> |
| Step 5 | <i>Verify.</i> | |
| | • Check all lines | • dsplns |
| | • View specific line | • dspln <line number> |
| Step 6 | <i>Add Port.</i> | |
| | • 2T3E3 | • addport <port number> <line number> <port type> |
| | • 2CT3 | • addport <port number> <line number> <ds0 speed> <begin slot> <number of slots> <port type> |
| | • 8T1/E1 | • addport <port number> <line number> <DS0 speed> <begin slot> <number of slots> <port type> |
| Step 7 | <i>Verify.</i> | |
| | • Check all ports | • dspports |
| | • View specific port | • dspport |
| Step 8 | <i>Set port resource partitions.</i> | cnfportrsprtn <port number> <controller> <percent BW> <low DLCI> <high DLCI> <max LCN> |
| Step 9 | <i>Verify.</i> | dspportrsprtn |
| Step 10 | <i>Add Connection.</i> | addcon <port> <DLCI> <CIR> <chan_type> <egress_service_type> <CAC> <controller_type> <mastership> <connID> <controller ID> |
| | • T1 | |
| Step 11 | <i>Verify.</i> | dspscon <port.DLCI> |
| Step 12 | <i>Configure Channel.</i> | |
| | • T1 | • cnfcon <port_num> <CDVT> <CLIP> <bufsize> <clockmode> <IdleSuppEnable> <ForceIdleSuppression> |
| | • T3 | • cnfcon <port> <CDVT> <CellLossIntegPeriod> <bufsize> |
| Step 13 | <i>Verify.</i> | |
| | • Check all connections | • dspscons |
| | • View specific connection | • dspscon |

Running FRSM Tests

- Setting Up Local Loopback Testing on a High-Speed FRSM
- Setting Up Local Loopback Testing on a High-Speed FRSM
- Setting Up T3 BERT Testing on an FRSM 2T3E3

Setting Up Local Loopback Testing on a Low-Speed FRSM

You can initiate a local line loopback on FRSM T1/E1 cards. Other loopbacks (such as remote loopbacks and far-end loopback) can be initiated through the SRM BERT functions.

Bring up the FRSM command prompt to set up the following loopback functions.

- | | | |
|---------------|---|---|
| Step 1 | <i>Set up the local line loopback.</i> | addlnloop <line_num> |
| Step 2 | <i>Configure loopback code detection.</i> | cnflnloop <line_num> <lpbkCodeDetection> |
| Step 3 | <i>Set up loopbacks on connections.</i> | addchanloop <chan_num> |
| Step 4 | <i>Verify.</i> | dspln <line_num> |
| Step 5 | <i>Remove the loopback configuration.</i> | dellnloop <line_num> |

Setting Up Local Loopback Testing on a High-Speed FRSM

You can initiate a local line loopback on FRSM T3/E3 cards. Other loopbacks (such as remote loopbacks, far-end loopback) can be initiated through the SRM BERT functions.

Bring up the FRSM command prompt to set up the following loopback functions.

- | | | |
|---------------|---|--|
| Step 1 | <i>Set up the local line loopback.</i> | addds3loop <line_num> |
| Step 2 | <i>Configure loopback code detection.</i> | cnflnloop <line_num> <lpbkCodeDetection> |
| Step 3 | <i>Set up loopbacks on connections.</i> | addchanloop <chan_num> |
| Step 4 | <i>Verify.</i> | <ul style="list-style-type: none"> • dspds3ln <line_num> • dspds3lns |
| Step 5 | <i>Remove the loopback configuration.</i> | delds3loop <line_num>
dspds3ln <line_num> <lpbkCodedetection> |

Setting Up T3 BERT Testing on an FRSM 2T3E3

Bring up the FRSM command prompt to set up the following loopback functions.

- Step 1** *Configure BERT.* **cnfdsx3bert** <line_num> <test-pattern>
- Step 2** *Configure a line.* **xcnfln** <LineNum> **-e** <dsx3LineEnable> **-ds3ben** <dsx3LineBERTEnable>
- Step 3** *Insert errors on the line.* **moddsx3bert** <error_ir>
- Step 4** *Verify.* **dspdsx3bert**
- Step 5** *Stop the BERT testing session.* **deldsx3bert**

AUSM Configurations

This section contains typical command sequences associated with the MGX 8800 ATM User Service Module.

Setting Up AUSM Connectivity

Bring up the AUSM command prompt to do this configuration.

Step 1 *Set card resource partitions.* **cnfcdrcsprtn** <PAR_max_conns> <PNNI_max_conns> <Tag_max_conns>

Step 2 *Verify.* **dspecdrcsprtn**

Step 3 *Add Line.* **addln** <line number>

Step 4 *Verify.* **dspln** <line number>

Step 5 *Configure Line.* **cnfln** <line num> <line_code> <line_len> <clk_src> [E1-signalling]

Step 6 *Verify.* **dspln** <line number>

- *Check all lines.* **dspln** <line number>
- *View specific line.* **dspln** <line number>

Step 7 *Decision: Narrowband or IMA?*

Narrowband

- *Add Port.* (max 1 per line) **addport** <port_num> <port type> <line_num>
- *Verify.*
 - *Check all ports.* **dspports**
 - *View specific port.* **dspport** <port_num>

IMA

- *Add group.* (max 8 logical ports per AUSM) **addimagrp** <group_num> <port_type> <list_of_links> min_num_links>
 - *Verify.*
 - *Check all groups.* **dspimagrps**
 - *View specific group.* **dspimagrp**
 - *Configure the group.* **cnfimagrp** <group_num> <max_diff_delay> <min_num_links>
 - *Add lines to the group.* **addlns2imagrp** <group_num> <list_of_lines>
 - *Verify.* **dspimagrp**
 - *Set IMA alarm parameters.* **cnfimaalmparm** <group_num> <uptime> <downtime>
- Step 8** *Add Connection.* **addcon** <port_num> <vpi> <vci> <conn_type> <service_type> [Controller_Type] [mastership] [remoteConnID]
- Step 9** *Verify.* **dspon** <port.VPI.VCI>

Debugging AUSM

- Checking AUSM Line Connections
- Checking AUSM IMA Group

Checking AUSM Line Connections

Bring up the AUSM command prompt to perform the following debugging functions.

- *Display port queue* **dspportq** <port number> <egress queue number>
- *Display port counters* **dspportcnt** <port number>
- *Display alarms* **dspalms** <lineType>
- *Display alarm count* **dspalmcnt -ds1** <LineNum>
- *Display channel counters* **dspchancnt** <Port.VPI.VCI>
- *Display Load* **dspsarcnt** <ChanNum>
- *Display SAR counters* **dspsarcnt** <ChanNum>

Checking AUSM IMA Group

You probably won't do these things unless the IMA Group is not functioning properly.

Bring up the AUSM command prompt to perform the following debugging functions.

- *Display lines: Check to ensure that lines are clear of alarms at both ends.* **dspimaln** <imagroup> <linenum>
- *Check Tx and Rx LSM states on constituent links.* **dspimaln** <imagroup> <linenum>
- *Display the group configuration for both ends; check for constituent links.* **dspimagrp** <lineType>
- *Check observed differential delay.* **dspimagrp** <lineType>

Running AUSM Tests

- AUSM Connections
- IMA
- Loopbacks

AUSM Connections

- *Test the connection.* **tstcon** <Port.vpi.vci>
- *Test connection segment.* **tstconseg** <Port.vpi.vci>
- *Test the delay.* **tstdelay** <Port.vpi.vci>

IMA

Bring up the AUSM command prompt to perform the following debugging functions.

- *Configure IMA Test.* **cnfimatst** <group_num> <Test_link_num><test_pattern> <test_proc_status>
- *Verify.* **dspimatst** <group_num>

Loopbacks

The following loopbacks can be executed on an AUSM.

- Remote loopback—Puts the card in remote line loopback mode, as enabled or disabled by FDL messages.
- Local line loopback—Works on the network side, as initiated by the **addlnloop** command.
- Local LCN/Channel loopback—Set up by LCN, as initiated by the **addchanloop** command.

Setting up a Local Line Loopback on an AUSM

Bring up the AUSM command prompt.

- *Set loopback on a specified AUSM line.* **addlnloop** <linenum>
- *Stop the loopback.* **dellnloop** <linenum>

Setting up an LCN/Channel Loopback on an AUSM

Bring up the AUSM command prompt.

- *Set loopback on a specified AUSM port.* **addchanloop** <Port.vpi.vci>
- *Stop the loopback.* **delchanloop** <Port.vpi.vci>

